

Haworth Price Adjustment

A non-discountable 1.75% increase to list price will be applied to all orders placed after April 07, 2025

10 Wire Power

GSA Price List – March 2025

Includes 4-4-2, 6-2-2 and International Power



This price list is based upon Haworth's February 2025 commercial pricing.
GENERAL SERVICES ADMINISTRATION FEDERAL SUPPLY SERVICE
Authorized Federal Supply Scheduled Price List (Catalog) Office Furniture, Wood Casegoods and Tables
(FSC Group 71, Part I, FSC Classes 7105, 7110, 7125 and 7195)
Contract No: GS-03F-057DA | Contract Period: February 8, 2016 – February 7, 2026 | Business: Large
Contractor: Haworth, Inc. | One Haworth Center | Holland, MI 49423-9576 | 1.616.393.3000



This Haworth North American price book contains US list prices.

Canadian customers can convert the US list price into their Canadian equivalent by going to www.Haworth.com/Canada to find the current Canadian multipliers. These multiplier factors allow you to convert the US list price into a Canadian list price.

HAWORTH, INC.

GENERAL SERVICES ADMINISTRATION

FEDERAL ACQUISITION SERVICES

Authorized Federal Supply Schedule Furniture (FSC Group 71, FSC Classes 7105, 7110, 7125 and 7195)

| | |
|----------------------|--|
| Contract Number: | GS-03F-057DA |
| Contract Start Date: | February 8, 2016 |
| Contract End Date: | February 7, 2026 |
| Contractor: | HAWORTH, INC. One Haworth Center Holland, MI 49423-9576 1-616-393-3000 http://www.haworth.com/government |
| Business Size: | Large |

Information for Ordering Activities I-FSS-600

Online access to Haworth's Authorized Federal Supply Schedule contract ordering information, terms and conditions, and up-to-date product and discount listing can be found at GSA Advantage, eLibrary link [here](#).

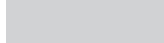

This Page Intentionally Left Blank

10 Wire Power Price List

Includes pricing, catalog numbers, finish codes/availability, specification requirements, line art, dimensions, and specification tips for 4-4-2 Power, 6-2-2 Power and International Power.

4-4-2 Power

6-2-2 Power

International Power

Table of Contents

Price List

| | |
|---|-------------------|
| Statement of Line | 7 |
| 4-4-2 — Electrical Components | |
| Compose 4-4-2 — Electrical Components | |
| Base Feed Module – Hardwire Connection | 11 |
| Top Feed Module | 12 |
| Top Feed Harness | 12 |
| Raceway Retrofit Kit | 13 |
| Raceway Covers | 13 |
| Blank Plate | 13 |
| Flexible Power Connector | 14 |
| Belong Jumper | 15 |
| Belong Infeed Harness | 15 |
| Flexible Power Connector – Straight Span, Raceway | 16 |
| Extended Flexible Power Connectors for Base Raceway | 16 |
| Receptacles | 17 |
| 6-2-2 — Electrical Components | |
| Compose 6-2-2 — Electrical Components | |
| Base Feed Module – Hardwire Connection | 20 |
| Top Feed Module | 21 |
| Top Feed Harness | 21 |
| Raceway Retrofit Kit | 22 |
| Raceway Covers | 22 |
| Blank Plate | 22 |
| Flexible Power Connector | 23 |
| Flexible Power Connector – Straight Span, Raceway | 24 |
| Extended Flexible Power Connectors for Base Raceway | 24 |
| Receptacles | 25 |
| International Power — Electrical Components | |
| Electrical Components | |
| Compose International — Electrical Components | |
| Base Feed Module – Hardwire Connection | 29 |
| Top Feed Module | 30 |
| Top Feed Harness | 30 |
| Raceway Retrofit Kit | 31 |
| Raceway Covers | 31 |
| Blank Plate | 31 |
| Flexible Power Connector | 32 |
| Straight-Span Flexible Power Connector | 33 |
| Extended Flexible Power Connectors for Base Raceway | 33 |
| Receptacles | 34 |
| Index | 37 |
| Lifetime Product Warranty | Inside Back Cover |

Statement of Line

Compose 4-4-2 – Electrical Components

Pages 11-17

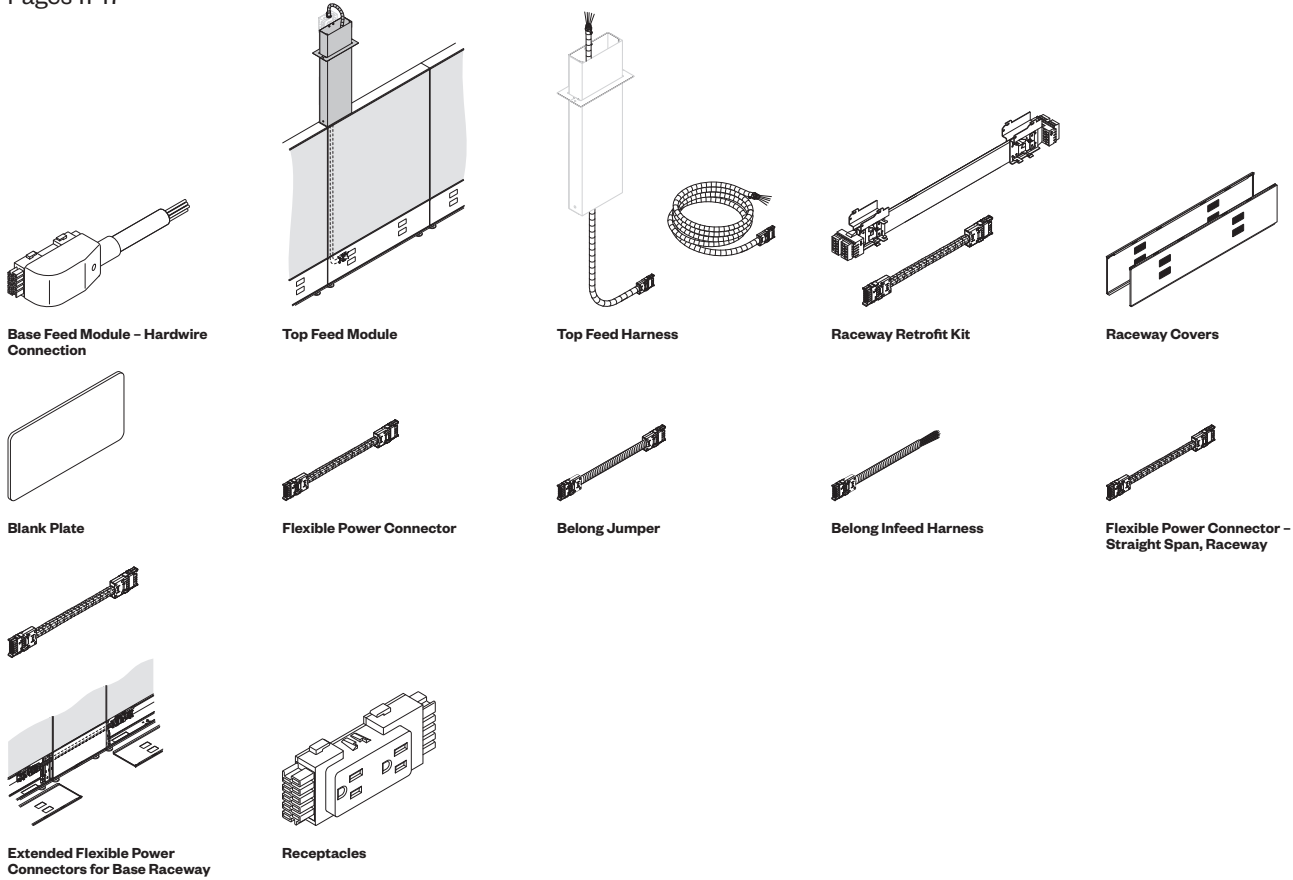

Compose 6-2-2 – Electrical Components

Pages 20-25

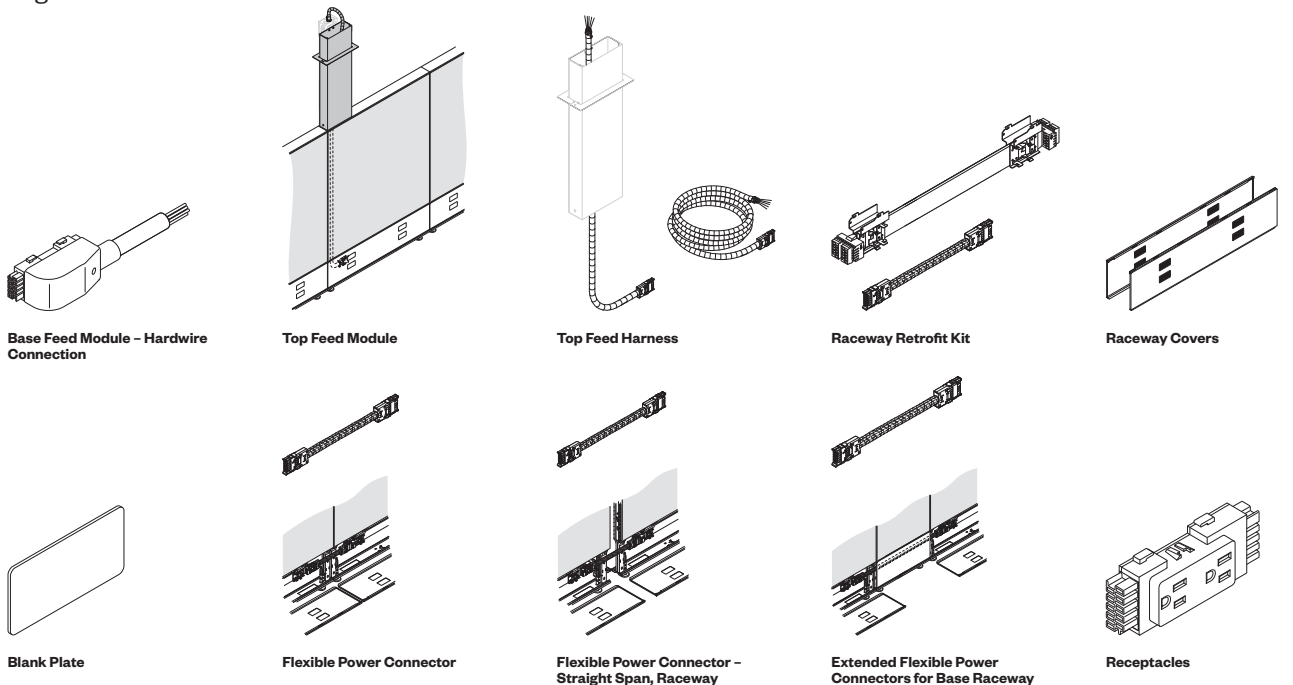

Statement of Line

Compose International – Electrical Components

Pages 29-34

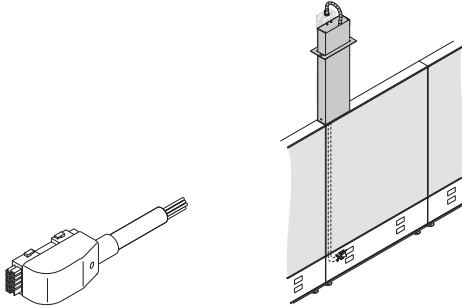

Base Feed Module – Hardwire Connection

Top Feed Module

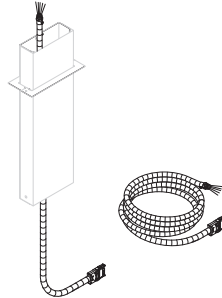

Top Feed Harness

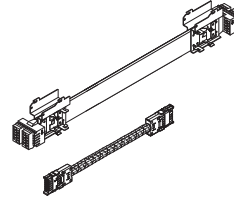

Raceway Retrofit Kit

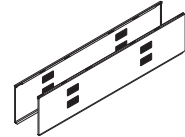

Raceway Covers

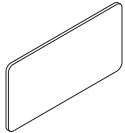

Blank Plate

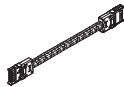

Flexible Power Connector

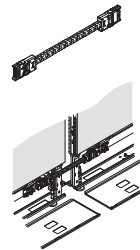

Straight-Span Flexible Power Connector

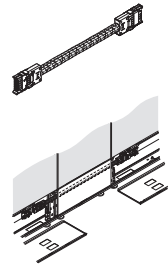

Extended Flexible Power Connectors for Base Raceway

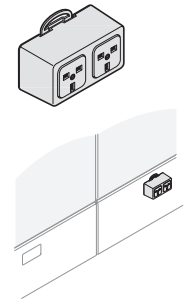

Receptacles

4-4-2 Power

4-4-2 — Electrical Components

The 4-4-2 power option is available for base raceway locations on Compose panels. 4-4-2 power components must be specified separately from the panel. To order, specify non-powered panels without raceway covers, base power kit and 4-4-2 power raceway covers. Specify base feed, top feed, connectors and receptacles separately. The 4-4-2 power provides up to six 20 amp circuits. This 10 wire system is configured with 3 hots that share neutral #1 and another 3 hots that share neutral #2, common and isolated ground.

Retrofit Kit

The retrofit kit includes a Power Distribution Assembly (PDA) and flexible power connector, specify raceway covers separately. Kits are available for 24"-60" panels.

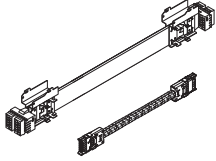

Raceway Covers

The raceway cover has a receptacle opening specifically for the 4-4-2 power receptacle. The Compose 4-4-2 power raceway covers have receptacle and data port openings.

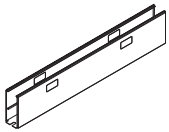

Base Feed

The base feed is used to connect to building power located in the floor, wall or column. The base feed plugs into the PDA at a receptacle opening.

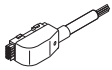

Top Feed

Top feed is used to connect to building power above a ceiling. The top feed pole mounts to the top of a 24"-60" panel. The top feed harness routes through the pole to the panel base raceway. The harness connects to the PDA at the connector location.

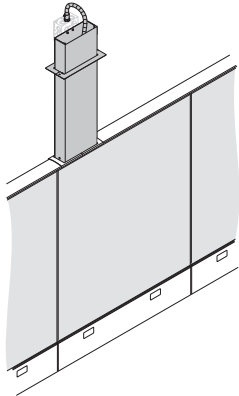

Flexible Power Connectors

Flexible power connectors are used to carry power from panel to panel. Only one flexible power connector is needed to pass 4-4-2 power to the next panel. The 14" flexible power connector (included in retrofit kit) is used to connect adjacent panels in straight, 90° or 120° flexible power configurations. The straight span flexible 16.5" connector is used to span across 3-way or 4-way panel intersections. An extended flexible power connector is used to pass through an 18" panel.

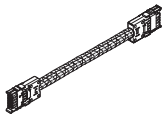

Receptacle

Receptacles are packaged in 6 packs. Receptacles have a duplex 15 amp (NEMA 5-15R) face configuration. Receptacles have fixed circuit access and are not field programmable. Specify appropriate number of receptacles for each circuit. Circuit 1, 2 or 3 receptacles connect to common ground. Circuit 4, 5 or 6 receptacles connect to isolated ground.

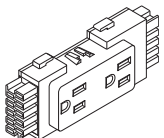

Compose 4-4-2 — Electrical Components

Base Feed Module – Hardwire Connection

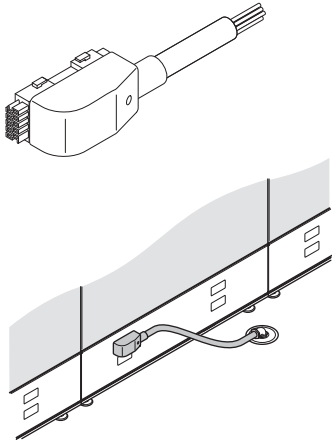

VZEB-0000-4I
Class BC



Features

- Includes one base feed with 4'(1219mm) long, black 0.75"(19mm) flexible metal conduit with ten 12-gauge for up to four 20 amp circuits of power.
- For floor, column, or wall hardwire connections.
- For use with tiles equipped with 4-4-2 power components.
- Base feed module can be field modified to accommodate left or right hand conditions.
- Attaches at any one of the four receptacle sites in a powered base raceway.
- Standard in black trim color only.

Specification Tips

- Not for use with tile to the floor panel applications; requires powered 4-4-2 base raceway cover.
- Not for use with power sources other than 120 volt 60 hertz.
- Do not mix with Power Base (3-, 4- or 6-circuit power) or Power Base AI components.

To Order, Specify:

- 1) Product number.
(No finish specification required.)

| Feed Length | Description | Number | Price |
|-------------|--------------------|--------------|-----------|
| 4'(1219mm) | 4-4-2 Four Circuit | VZEB-0000-4I | \$ 958.32 |
| 10'(3048mm) | | VZEB-00C0-4I | 1092.32 |

Compose 4-4-2 — Electrical Components

Top Feed Module

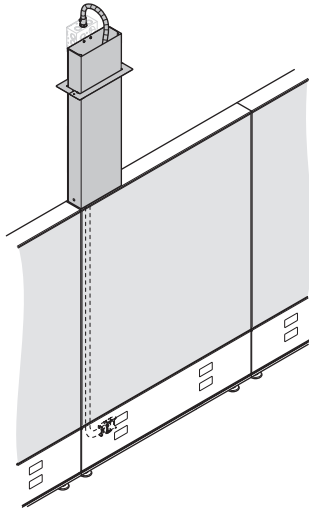

VZET-4WI
Class BC

Features

- Includes electrical harness in 0.75”(19mm) galvanized metal conduit ten 12-gauge wires for up to four 20 amp circuits of power, 2.5” x 8” pole and mounting hardware.
- For use with panels equipped with 4-4-2 power components.
- For ceiling heights up to 12’.
- Top feed pole can accommodate left or right hand applications.
- Attaches at any one of the four connector sites in a powered base raceway of a panel.

Specification Tips

- Power is only available at base raceway.
- Junction box at top of pole to be supplied by local electrician.
- Not for use with power sources other than 120 volt 60 hertz.
- Do not mix with Power Base (3-, 4- or 6-circuit) or Power Base AI components.

Note: Wire harness length is 180”(4572mm) regardless of pole length.

To Order, Specify:

1) Product number, including:

1 Panel Trim

A Aluminum or Wood

H Steel

2) Trim color.

| Panel Height | Pole Length | Number | Trim | |
|---------------------------|--------------|----------------|-----------|-----------|
| | | | A | B |
| 12' Ceiling Height | | | | |
| 34”(864mm) - 50”(1270mm) | 119”(3023mm) | VZET-3400-4W I | \$3042.92 | \$3260.57 |
| 58”(1473mm) - 90”(2286mm) | 95”(2413mm) | VZET-6600-4W I | 2983.40 | 3154.97 |

Top Feed Harness

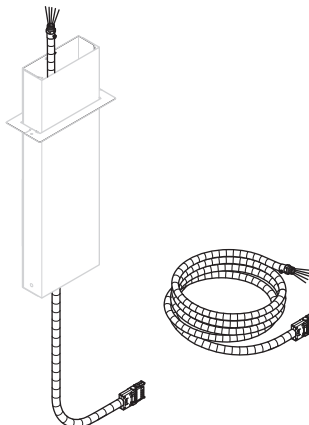

VZEH-0000-4WI
Class BC



Features

- Includes electrical harness 0.75”(19mm) galvanized metal conduit ten 12-gauge wires for up to four 20 amp circuits of power.
- For use with panels equipped with 4-4-2 power components.
- For ceiling height up to 12’.
- Attaches at any one of the four connector sites in a powered base raceway of a panel.

Specification Tips

- May also be used to feed power from raised floors or columns.
- Not for use with power sources other than 120 volt 60 hertz.
- Do not mix with Power Base (3-, 4- or 6-circuit) or Power Base AI components.

NOTE: Wire harness length is 180”(4572mm).

To Order, Specify:

1) Product number.
(No finish specification required.)

| Description | Harness Length | Number | Price |
|-------------|----------------|---------------|-----------|
| 4-4-2 | 180”(4572mm) | VZEH-0000-4WI | \$1362.56 |

Compose 4-4-2 — Electrical Components

Electrical Accessories

Raceway Retrofit Kit

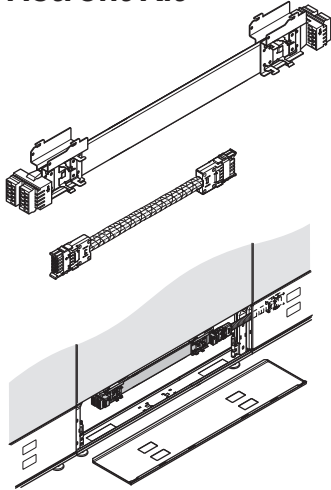

VZEP-4I
Class BC



Features

- Includes power distribution assembly (PDA), one 14"(356mm) power connector and mounting hardware.
- Converts non-powered panels to powered panels.

Specification Tips

- 8"(203mm) tiles cannot be used in place of base raceway cover.
- Field mounting of PDA is required.
- Specify raceway covers and blank plates separately.
- Do not mix with Power Base (3-, 4- or 6-circuit).

To Order, Specify:

- 1) Product number.
(No finish specification required.)

| Panel Width | Number | Price |
|-------------|--------------|-----------|
| 24"(610mm) | VZEP-0024-4I | \$1203.90 |
| 30"(762mm) | VZEP-0030-4I | 1226.14 |
| 36"(914mm) | VZEP-0036-4I | 1248.38 |
| 42"(1067mm) | VZEP-0042-4I | 1270.62 |
| 48"(1219mm) | VZEP-0048-4I | 1292.86 |
| 54"(1372mm) | VZEP-0054-4I | 1315.10 |
| 60"(1524mm) | VZEP-0060-4I | 1357.71 |
| 66"(1676mm) | VZEP-0066-4I | 1359.58 |
| 72"(1829mm) | VZEP-0072-4I | 1607.35 |

Raceway Covers

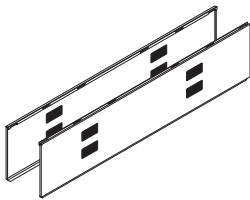

VZEK
Class BC



Features

- Includes two painted metal covers with receptacle and data openings.
- For use with panels equipped with 4-4-2 power components.
- Data opening is 1.38"(35mm) x 2.71"(69mm) for attachment of Modular Furniture Telecommunication Faceplates.

Specification Tips

- 8"(203mm) tiles cannot be used in place of base raceway cover.
- 18"(457mm) raceway cover has no knockouts.
- When metallic trim is specified on raceway covers, data blank plates recommended with the following trim colors:
 - Silver (TR-LE) = Smoke (TR-E)
 - Champagne (TR-MC) = Smoke (TR-E)
 - Gunmetal (TR-MG) = Graphite (TR-J)

- **Separately specify VZAD-0000-R to cover unused receptacle and data openings.**

To Order, Specify:

- 1) Product number.
- 2) Trim color.

| Panel Width | Number | Trim | |
|-------------|---------------|----------|----------|
| | | A | B |
| 18"(457mm) | VZEK-OR18-NBB | \$296.24 | \$307.36 |
| 24"(610mm) | VZEK-OR24-6H | 620.63 | 627.09 |
| 30"(762mm) | VZEK-OR30-6H | 638.65 | 646.01 |
| 36"(914mm) | VZEK-OR36-6H | 656.67 | 664.93 |
| 42"(1067mm) | VZEK-OR42-6H | 674.69 | 683.85 |
| 48"(1219mm) | VZEK-OR48-6H | 692.71 | 702.77 |
| 54"(1372mm) | VZEK-OR54-6H | 710.73 | 721.69 |
| 60"(1524mm) | VZEK-OR60-6H | 728.75 | 740.61 |

Blank Plate

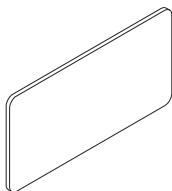

VZAD-0000-R
Class BC

Features

- Includes one cover.
- Used to cover unused 1.38"(35mm) x 2.71"(69mm) receptacle or communication openings in base raceway cover.

To Order, Specify:

- 1) Product number.
- 2) Non-metallic trim color.

| Height | Width | Number | Price |
|------------|------------|-------------|--------|
| 1.6"(41mm) | 3.1"(79mm) | VZAD-0000-R | \$5.36 |

Compose 4-4-2 — Electrical Components

Horizontal Power Connector – Base Raceway and Beltline Power Applications

Flexible Power Connector

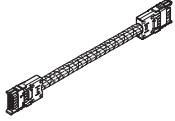

VZEF-OROP-4I
Class BC

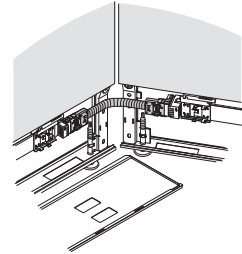
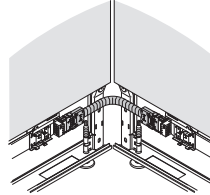
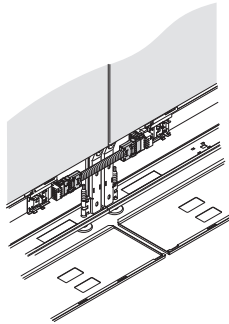

Features

- Includes one flexible power connector with safety latches for securing connector to power block.
- Continues electrical circuits between base panels in straight, 90° or 120° conditions
- For use with panels equipped with 4-4-2 power components.

Specification Tips

- Do not mix with Power Base (3-, 4- or 6-circuit).
- 14"(356mm) connector ships with each powered kit.

To Order, Specify:

- 1) Product number.
(No finish specification required.)

| Length | Number | Price |
|------------|--------------|----------|
| 14"(356mm) | VZEF-OROP-4I | \$510.03 |

Compose 4-4-2 — Electrical Components

Belong Jumper

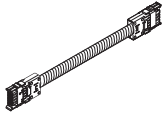

EUEJ
Class YA

Features

- Includes one flexible power connector with safety latches for securing connector to power block.
- Continues electrical circuits between base panels in straight, 90° or 120° conditions
- For use with panels equipped with 4-4-2 power components.

Specification Tips

- Do not mix with Power Base (3-, 4- or 6-circuit).
- 14"(356mm) connector ships with each powered kit.

To Order, Specify:

- 1) Product number.
(No finish specification required.)

| Panel Width | Length | Number | Price |
|--------------|--------------|--------------|-----------|
| 24"(610mm) | 24"(610mm) | EUEJ-0024-4I | \$ 189.55 |
| 30"(762mm) | 30"(762mm) | EUEJ-0030-4I | 200.35 |
| 36"(914mm) | 36"(914mm) | EUEJ-0036-4I | 211.15 |
| 42"(1067mm) | 42"(1067mm) | EUEJ-0042-4I | 221.95 |
| 48"(1219mm) | 48"(1219mm) | EUEJ-0048-4I | 232.75 |
| 54"(1372mm) | 54"(1372mm) | EUEJ-0054-4I | 243.55 |
| 60"(1524mm) | 60"(1524mm) | EUEJ-0060-4I | 254.35 |
| 76"(1930mm) | 76"(1930mm) | EUEJ-0076-4I | 283.15 |
| 96"(2438mm) | 96"(2438mm) | EUEJ-0096-4I | 319.15 |
| 144"(3658mm) | 144"(3658mm) | EUEJ-00E4-4I | 333.55 |

Belong Infeed Harness

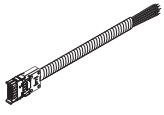

EUEH
Class YA

Features

- Includes one flexible power connector with safety latches for securing connector to power block.
- Continues electrical circuits between base panels in straight, 90° or 120° conditions
- For use with panels equipped with 4-4-2 power components.

Specification Tips

- Do not mix with Power Base (3-, 4- or 6-circuit).
- 14"(356mm) connector ships with each powered kit.

To Order, Specify:

- 1) Product number.
(No finish specification required.)

| Length | Number | Price |
|-------------|--------------|----------|
| 87"(2210mm) | EUEH-0087-4I | \$334.60 |

Compose 4-4-2 — Electrical Components

Flexible Power Connector – Straight Span, Raceway

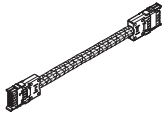

VZEF-0ROS-4I
Class BC

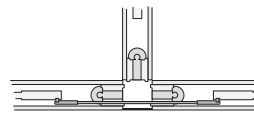
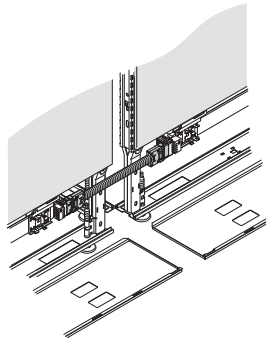

Base straight span condition

Features

- Includes one straight span flexible power connector with safety latches for securing connector to power distribution assembly.
- Continues electrical circuit across the three-inch space between base powered panels in 3-way or 4-way conditions.
- For use with panels equipped with 4-4-2 power components.
- May be used at the base raceway for straight span conditions.

Specification Tips

- Not for use with below worksurface, beltline or not and standing height applications.
- Straight span flexible power connector must be separately specified.
- Do not mix with Power Base (3-, 4- or 6-circuit).

To Order, Specify:

- 1) Product number.
(No finish specification required.)

| Length | Number | Price |
|--------------|--------------|----------|
| 16.5"(419mm) | VZEF-0ROS-4I | \$510.03 |

Extended Flexible Power Connectors for Base Raceway

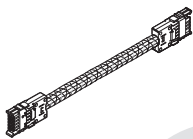

VZEJ-0018-4I
Class BC

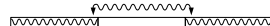

Straight Condition

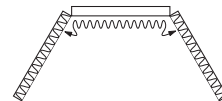

120° Condition

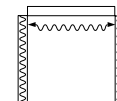

(2) 90° Conditions

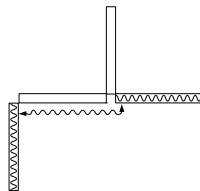

90° and 3-Way Condition

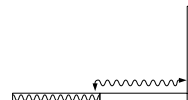

90° Condition

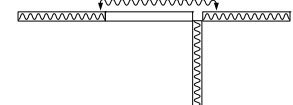

3-Way Condition

Features

- Includes one extended flexible metal power connector with safety latches.
- Spans base power through **one** 18"(457mm) non-powered panel located between two powered panels in any condition.
- For use with panels equipped with 4-4-2 power components.
- Extended power connectors cannot be coupled together.
- Standard in charcoal trim with metal conduit.

Specification Tips

- **Specify for use in base raceway only.**
- Not for use with hard surface tiles to the floor.
- Do not mix with Power Base (3-, 4- or 6-circuit).

To Order, Specify:

- 1) Product number.
(No finish specification required.)

| Panel Width | Length | Number | Price |
|-------------|------------|--------------|----------|
| 18"(457mm) | 36"(914mm) | VZEJ-0018-4I | \$318.41 |

Compose 4-4-2 — Electrical Components

Electrical Accessories

Receptacles

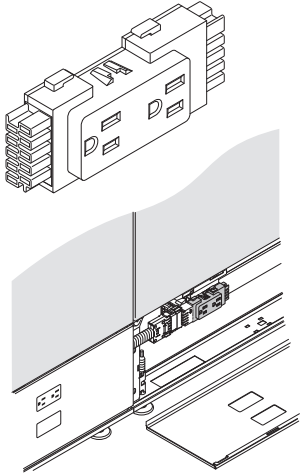

VZER-1500
Class FA



Features

- Includes box of six receptacles, each receptacle has two 15 amp outlets (NEMA 5-15R configuration).
- For use with panels equipped with 4-4-2 power components.
- Receptacles are circuit and ground type specific.
- Standard in black trim color only.

Specification Tips

- Common ground receptacles are available with common ground access only. Isolated ground receptacles are available with isolated ground access only.
- **Receptacles have fixed circuit access and are not field programmable. Specify appropriate number of receptacles for each circuit.**
- For power access at base location with panels equipped with appropriate base raceway covers.
- Do not mix with Power Base (3-, 4- or 6-circuit).

To Order, Specify:

- 1) Product number.
(No finish specification required.)

| Description | Circuit Access | Ground Type | Number | Price |
|-------------|----------------|-------------|----------------|----------|
| 15A Duplex | Circuit 1 | Common | VZER-1500-M14I | \$693.12 |
| | Circuit 2 | | VZER-1500-M24I | 693.12 |
| | Circuit 3 | | VZER-1500-M34I | 693.12 |
| | Circuit 4 | | VZER-1500-M44I | 693.12 |
| 15A Duplex | Circuit 1 | Isolated | VZER-1500-I14I | \$693.12 |
| | Circuit 2 | | VZER-1500-I24I | 693.12 |
| | Circuit 3 | | VZER-1500-I34I | 693.12 |
| | Circuit 4 | | VZER-1500-I44I | 693.12 |

6-2-2 Power

6-2-2 — Electrical Components

The 6-2-2 power option is available for base raceway locations on Compose panels. 6-2-2 power components must be specified separately from the panel. To order, specify non-powered panels without raceway covers, base power kit and 6-2-2 power raceway covers. Specify base feed, top feed, connectors and receptacles separately. The 6-2-2 power provides up to six 20 amp circuits. This 10 wire system is configured with 3 hots that share neutral #1 and another 3 hots that share neutral #2, common and isolated ground.

Retrofit Kit

The retrofit kit includes a Power Distribution Assembly (PDA) and flexible power connector, specify raceway covers separately. Kits are available for 24"-60" panels.

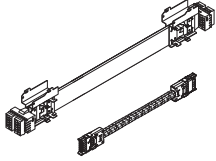

Raceway Covers

The raceway cover has a receptacle opening specifically for the 6-2-2 power receptacle. The Compose 6-2-2 power raceway covers have receptacle and data port openings.

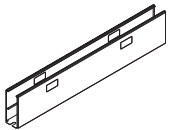

Base Feed

The base feed is used to connect to building power located in the floor, wall or column. The base feed plugs into the PDA at a receptacle opening.

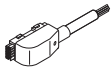

Top Feed

Top feed is used to connect to building power above a ceiling. The top feed pole mounts to the top of a 24"-60" panel. The top feed harness routes through the pole to the panel base raceway. The harness connects to the PDA at the connector location.

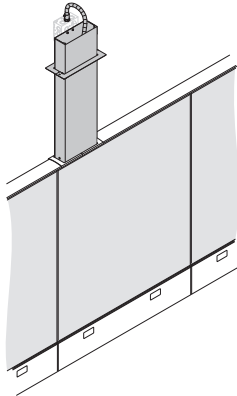

Flexible Power Connectors

Flexible power connectors are used to carry power from panel to panel. Only one flexible power connector is needed to pass 6-2-2 power to the next panel. The 14" flexible power connector (included in retrofit kit) is used to connect adjacent panels in straight, 90° or 120° flexible power configurations. The straight span flexible 16.5" connector is used to span across 3-way or 4-way panel intersections. An extended flexible power connector is used to pass through an 18" panel.

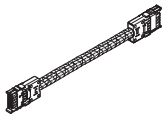

Receptacle

Receptacles are packaged in 6 packs. Receptacles have a duplex 15 amp (NEMA 5-15R) face configuration. Receptacles have fixed circuit access and are not field programmable. Specify appropriate number of receptacles for each circuit. Circuit 1, 2 or 3 receptacles connect to common ground. Circuit 4, 5 or 6 receptacles connect to isolated ground.

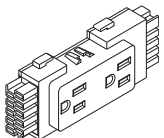

Compose 6-2-2 — Electrical Components

Base Feed Module – Hardwire Connection

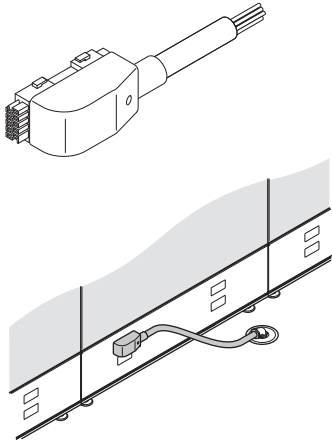

VZEB-0000-6
Class BC



Features

- Includes one base feed with 4'(1219mm) long, black 0.75"(19mm) flexible metal conduit with eight 12-gauge and two 10-gauge wires for up to six 20 amp circuits of power.
- For floor, column, or wall hardwire connections.
- For use with tiles equipped with 6-2-2 power components.
- Base feed module can be field modified to accommodate left or right hand conditions.
- Attaches at any one of the four receptacle sites in a powered base raceway.
- Standard in black trim color only.

Specification Tips

- Not for use with tile to the floor panel applications; requires powered 6-2-2 base raceway cover.
- Not for use with power sources other than 120 volt 60 hertz.
- Do not mix with Power Base (3-, 4- or 6-circuit power) or Power Base AI components.

To Order, Specify:

- 1) Product number.
(No finish specification required.)

| Feed Length | Description | Number | Price |
|-------------|-------------|-------------|----------|
| 4'(1219mm) | 3+3 | VZEB-0000-6 | \$966.67 |

Compose 6-2-2 — Electrical Components

Top Feed Module

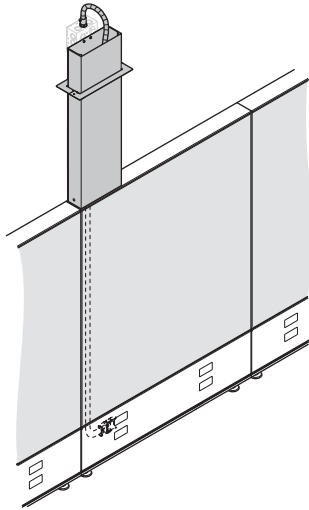

VZET-6W
Class BC

Features

- Includes electrical harness in 0.75"(19mm) galvanized metal conduit eight 12-gauge and two 10-gauge wires for up to six 20 amp circuits of power, 2.5" x 8" pole and mounting hardware.
- For use with panels equipped with 6-2-2 power components.
- For ceiling heights up to 12'.
- Top feed pole can accommodate left or right hand applications.
- Attaches at any one of the four connector sites in a powered base raceway of a panel.

Specification Tips

- Power is only available at base raceway.
- Junction box at top of pole to be supplied by local electrician.
- Not for use with power sources other than 120 volt 60 hertz.
- Do not mix with Power Base (3-, 4- or 6-circuit) or Power Base AI components.

Note: Wire harness length is 180"(4572mm) regardless of pole length.

To Order, Specify:

1) Product number, including:

1 Panel Trim

A Aluminum or Wood

H Steel

2) Trim color.

| Panel Height | Pole Length | Number | Price | |
|---------------------------|--------------|--------------|------------|-----------|
| | | | A | B |
| 12' Ceiling Height | | | | |
| 34"(864mm) - 50"(1270mm) | 119"(3023mm) | VZET-3400-6W | \$ 3125.12 | \$3342.77 |
| 58"(1473mm) - 90"(2286mm) | 95"(2413mm) | VZET-6600-6W | 3065.60 | 3237.17 |

Top Feed Harness

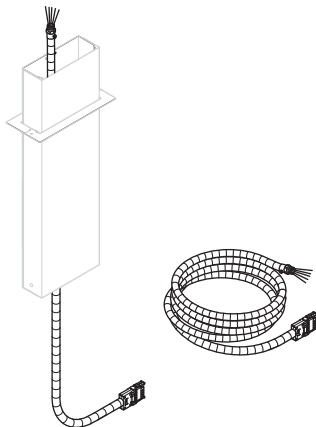

VZEH-0000-6W
Class BC

Features

- Includes electrical harness 0.75"(19mm) galvanized metal conduit eight 12-gauge and two 10-gauge wires for up to six 20 amp circuits of power.
- For use with panels equipped with 6-2-2 power components.
- For ceiling height up to 12'.
- Attaches at any one of the four receptacle sites in a powered base raceway of a panel.

Specification Tips

- May also be used to feed power from raised floors or columns.
- Not for use with power sources other than 120 volt 60 hertz.
- Do not mix with Power Base (3-, 4- or 6-circuit) or Power Base AI components.

NOTE: Wire harness length is 180"(4572mm).

To Order, Specify:

1) Product number.
(No finish specification required.)

| Description | Harness Length | Number | Price |
|-------------|----------------|--------------|-----------|
| 6-2-2 | 180"(4572mm) | VZEH-0000-6W | \$1401.76 |



Compose 6-2-2 — Electrical Components

Electrical Accessories

Raceway Retrofit Kit

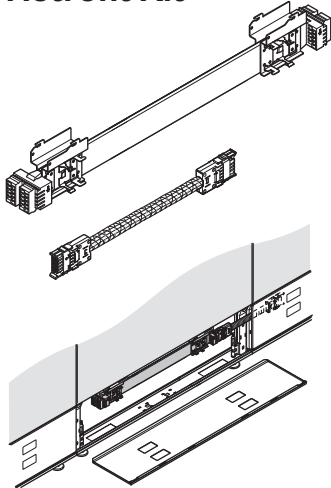

VZEP-6
Class BC

Features

- Includes power distribution assembly (PDA), one 14"(356mm) power connector and mounting hardware.
- Converts non-powered panels to powered panels.

Specification Tips

- 8"(203mm) tiles cannot be used in place of base raceway cover.
- Field mounting of PDA is required.
- Specify raceway covers and blank plates separately.
- Do not mix with Power Base (3-, 4- or 6-circuit).

To Order, Specify:

- 1) Product number.
(No finish specification required.)

| Panel Width | Number | Price |
|-------------|-------------|------------|
| 24"(610mm) | VZEP-0024-6 | \$ 1312.22 |
| 30"(762mm) | VZEP-0030-6 | 1334.46 |
| 36"(914mm) | VZEP-0036-6 | 1356.70 |
| 42"(1067mm) | VZEP-0042-6 | 1378.94 |
| 48"(1219mm) | VZEP-0048-6 | 1401.18 |
| 54"(1372mm) | VZEP-0054-6 | 1423.42 |
| 60"(1524mm) | VZEP-0060-6 | 1466.03 |

Raceway Covers

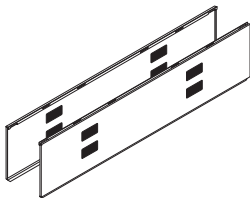

VZEK
Class BC

Features

- Includes two painted metal covers with receptacle and data openings.
- For use with panels equipped with 6-2-2 power components.
- Data opening is 1.38"(35mm) x 2.71"(69mm) for attachment of Modular Furniture Telecommunication Faceplates.

Specification Tips

- 8"(203mm) tiles cannot be used in place of base raceway cover.
- 18"(457mm) raceway cover has no knockouts.
- When metallic trim is specified on raceway covers, data blank plates recommended with the following trim colors:
 - Silver (TR-LE) = Smoke (TR-E)
 - Champagne (TR-MC) = Smoke (TR-E)
 - Gunmetal (TR-MG) = Graphite (TR-J)
- **Separately specify VZAD-0000-R to cover unused receptacle and data openings.**

To Order, Specify:

- 1) Product number.
- 2) Trim color.

| Panel Width | Number | Price | |
|-------------|---------------|----------|-----------|
| | | A | B |
| 18"(457mm) | VZEK-OR18-NBB | \$296.24 | \$ 307.36 |
| 24"(610mm) | VZEK-OR24-6H | 620.63 | 627.09 |
| 30"(762mm) | VZEK-OR30-6H | 638.65 | 646.01 |
| 36"(914mm) | VZEK-OR36-6H | 656.67 | 664.93 |
| 42"(1067mm) | VZEK-OR42-6H | 674.69 | 683.85 |
| 48"(1219mm) | VZEK-OR48-6H | 692.71 | 702.77 |
| 54"(1372mm) | VZEK-OR54-6H | 710.73 | 721.69 |
| 60"(1524mm) | VZEK-OR60-6H | 728.75 | 740.61 |

Blank Plate

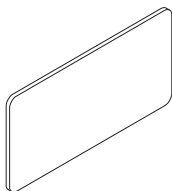

VZAD-0000-R
Class BC

Features

- Includes one cover.
- Used to cover unused 1.38"(35mm) x 2.71"(69mm) receptacle or communication openings in base raceway cover.

To Order, Specify:

- 1) Product number.
- 2) Non-metallic trim color.

| Height | Width | Number | Price |
|------------|------------|-------------|--------|
| 1.6"(41mm) | 3.1"(79mm) | VZAD-0000-R | \$5.36 |

Compose 6-2-2 — Electrical Components

Horizontal Power Connector – Base Raceway and Beltline Power Applications

Flexible Power Connector

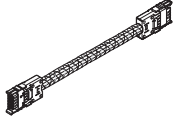

VZEF-OROP-6
Class BC

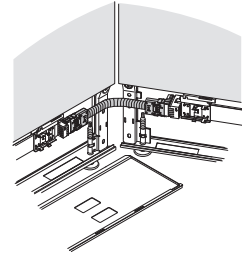
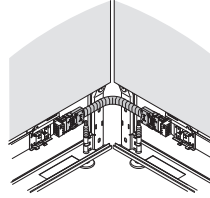
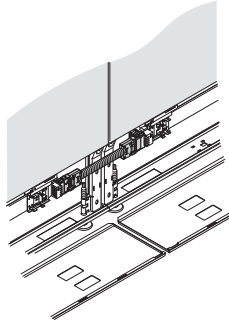

Features

- Includes one flexible power connector with safety latches for securing connector to power block.
- Continues electrical circuits between base panels in straight, 90° or 120° conditions
- For use with panels equipped with 6-2-2 power components.

Specification Tips

- Do not mix with Power Base (3-, 4- or 6-circuit).
- 14" (356mm) connector ships with each powered kit.

To Order, Specify:

- 1) Product number.
(No finish specification required.)

| Length | Number | Price |
|-------------|-------------|----------|
| 14" (356mm) | VZEF-OROP-6 | \$509.56 |

Compose 6-2-2 — Electrical Components

Flexible Power Connector – Straight Span, Raceway

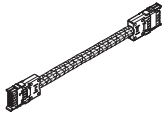

VZEF-OROS-6
Class BC

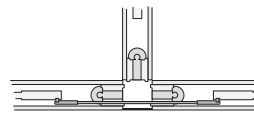
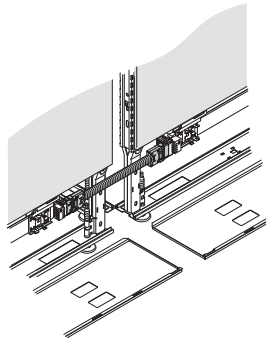

Base straight span condition

Features

- Includes one straight span flexible power connector with safety latches for securing connector to power distribution assembly.
- Continues electrical circuit across the three-inch space between base powered panels in 3-way or 4-way conditions.
- For use with panels equipped with 6-2-2 power components.
- May be used at the base raceway for straight span conditions.

Specification Tips

- Not for use with below worksurface, beltline or not and standing height applications.
- Straight span flexible power connector must be separately specified.
- Do not mix with Power Base (3-, 4- or 6-circuit).

To Order, Specify:

- 1) Product number.
(No finish specification required.)

| Length | Number | Price |
|--------------|-------------|----------|
| 16.5"(419mm) | VZEF-OROS-6 | \$441.48 |

Extended Flexible Power Connectors for Base Raceway

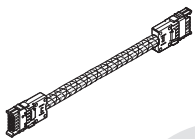

VZEJ-0018-6
Class BC

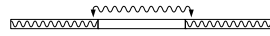

Straight Condition

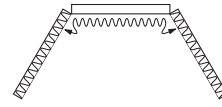

120° Condition

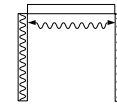

(2) 90° Conditions

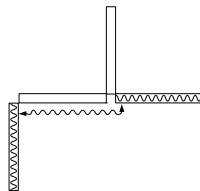

90° and 3-Way Condition

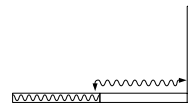

90° Condition

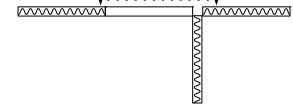

3-Way Condition

Features

- Includes one extended flexible metal power connector with safety latches.
- Spans base power through **one** 18"(457mm) non-powered panel located between two powered panels in any condition.
- For use with panels equipped with 6-2-2 power components.
- Extended power connectors cannot be coupled together.
- Standard in charcoal trim with metal conduit.

Specification Tips

- **Specify for use in base raceway only.**
- Not for use with hard surface tiles to the floor.
- Do not mix with Power Base (3-, 4- or 6-circuit).

To Order, Specify:

- 1) Product number.
(No finish specification required.)

| Panel Width | Length | Number | Price |
|----------------------|------------|-------------|----------|
| 18"(457mm)18"(457mm) | 36"(914mm) | VZEJ-0018-6 | \$574.57 |

Compose 6-2-2 — Electrical Components

Electrical Accessories

Receptacles

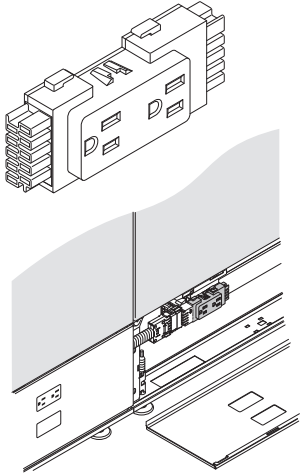

VZER-1500
Class FA



Features

- Includes box of six receptacles, each receptacle has two 15 amp outlets (NEMA 5-15R configuration).
- For use with panels equipped with 6-2-2 power components.
- Receptacles are circuit and ground type specific.
- Standard in black trim color only.

Specification Tips

- Circuits 1, 2 and 3 are available with common ground access only. Circuits 4, 5 and 6 are available with isolated ground access only.
- **Receptacles have fixed circuit access and are not field programmable. Specify appropriate number of receptacles for each circuit.**
- For power access at base location with panels equipped with appropriate base raceway covers.
- Do not mix with Power Base (3-, 4- or 6-circuit).

To Order, Specify:

- 1) Product number.
(No finish specification required.)

| Description | Circuit Access | Ground Type | Number | Price |
|-------------|----------------|-------------|---------------|----------|
| 15A Duplex | Circuit 1 | Common | VZER-1500-M16 | \$790.58 |
| | Circuit 2 | | VZER-1500-M26 | 790.58 |
| | Circuit 3 | | VZER-1500-M36 | 790.58 |
| 15A Duplex | Circuit 4 | Isolated | VZER-1500-I46 | \$790.58 |
| | Circuit 5 | | VZER-1500-I56 | 790.58 |
| | Circuit 6 | | VZER-1500-I66 | 790.58 |

International Power

International Power — Electrical Components

The International power option is available for base raceway locations on Compose panels. International power components must be specified separately from the panel. To order, specify non-powered panels without raceway covers, base power kit and international power raceway covers. Specify base feed, top feed, connectors and receptacles separately. The international power provides up to four circuits. This 10 wire system is configured with 4 line and neutral pairs and 2 grounding conductors.

Retrofit Kit

The retrofit kit includes a Power Distribution Assembly (PDA) and flexible power connector, specify raceway covers separately. Kits are available for 24"-60" panels.

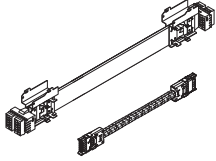

International Raceway Covers

The raceway cover has a receptacle opening specifically for the international power receptacle. The Compose international power raceway covers have receptacle and data port openings.

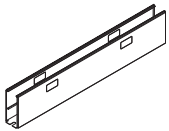

Base Feed

The base feed is used to connect to building power located in the floor, wall or column. The base feed plugs into the PDA at a receptacle opening.

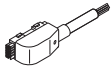

Top Feed

Top feed is used to connect to building power above a ceiling. The top feed pole mounts to the top of a 24"-60" panel. The top feed harness routes through the pole to the panel base raceway. The harness connects to the PDA at the connector location.

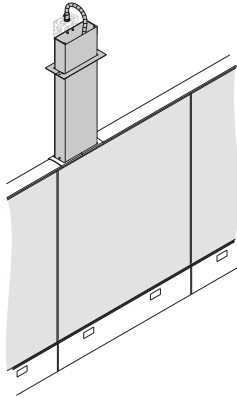

Flexible Power Connectors

Flexible power connectors are used to carry power from panel to panel. Only one flexible power connector is needed to pass international power to the next panel. The 14" flexible power connector (included in retrofit kit) is used to connect adjacent panels in straight, 90° or 120° flexible power configurations. The straight span flexible 16.5" connector is used to span across 3-way or 4-way panel intersections. An extended flexible power connector is used to pass through an 18" panel.

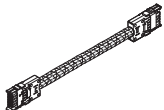

Receptacle

Receptacles are available in various country specific configurations. Receptacles have fixed circuit access and are not field programmable. Specify appropriate number of receptacles for each circuit. Receptacles are packaged in 3 packs.

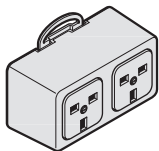

Electrical Components

International Electrical Wiring Configuration

International Electrical Wiring Configuration

INTERNATIONAL ELECTRICAL WIRING CONFIGURATIONS

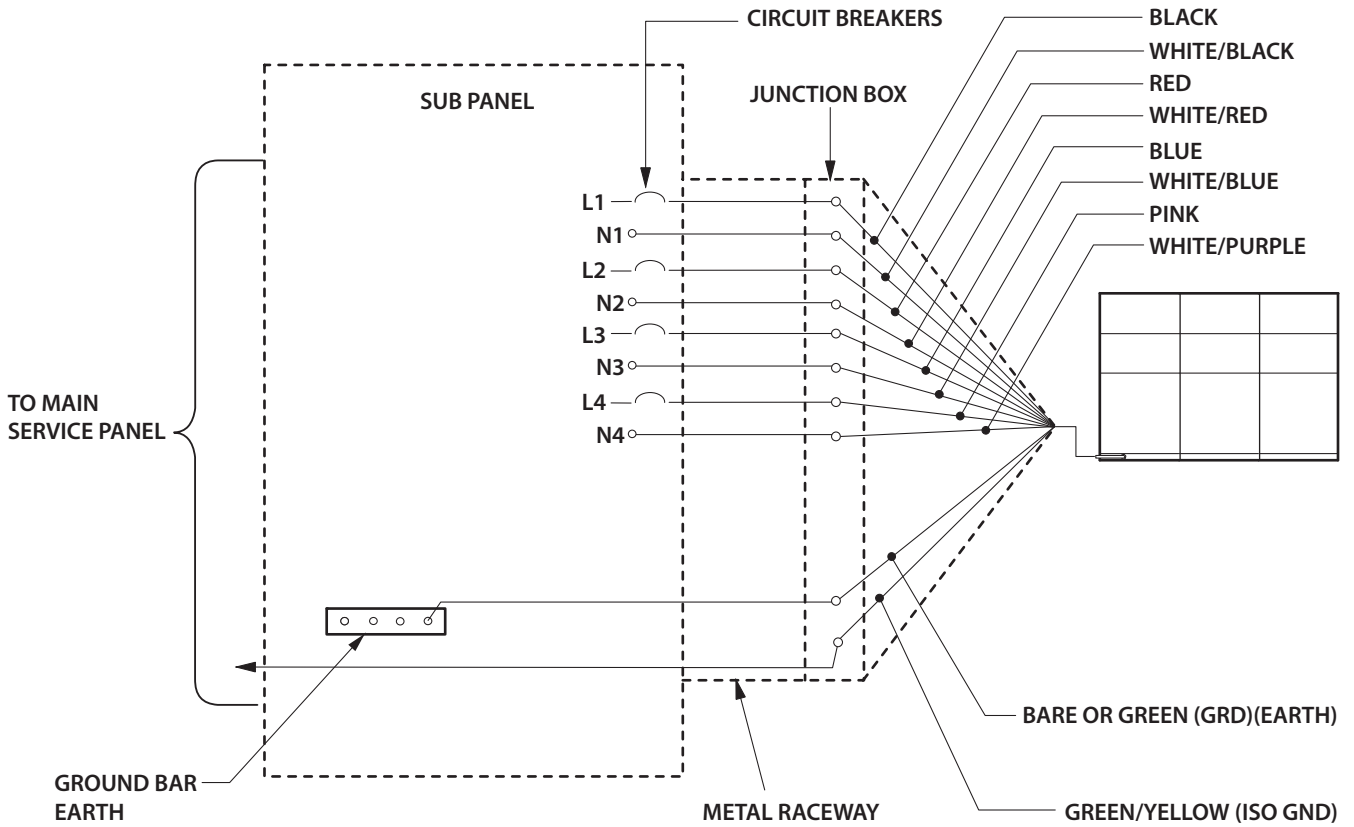

Wiring applications for all infeed types.

Compose International — Electrical Components

Base Feed Module – Hardwire Connection

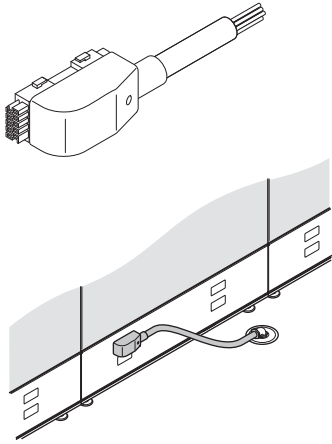

VZEB-0000-4l
Class BC

Features

- Includes one base feed with 4'(1219mm)long, black 0.75"(19mm) flexible metal conduit with ten 12-gauge wires for up to 4 circuits of power.
- For floor, column, or wall hardwire connections.
- For use with tiles equipped with international power components.
- Base feed module can be field modified to accommodate left or right hand conditions.
- Attaches at any one of the four receptacle sites in a powered base raceway.
- Standard in black trim color only.

Specification Tips

- Not for use with tile to the floor panel applications; requires powered international base raceway cover.
- Do not mix with Power Base (3-, 4- or 6-circuit power), Power Base AI or 6-2-2 power components.

To Order, Specify:

- 1) Product number.
(No finish specification required.)

| Feed Length | Number | Price |
|-------------|--------------|----------|
| 4'(1219mm) | VZEB-0000-4l | \$958.32 |

Compose International — Electrical Components

Top Feed Module

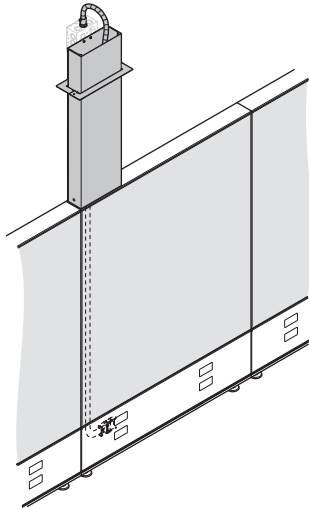

VZET-4WI
Class BC

Features

- Includes electrical harness in 0.75”(19mm) galvanized metal conduit with ten 12-gauge wires for up to four circuits of power, 2.5” x 8” pole and mounting hardware.
- For use with panels equipped with international power components.
- For ceiling heights up to 12’.
- Top feed pole can accommodate left or right hand applications.
- Attaches at any one of the four connector sites in a powered base raceway of a panel.

Specification Tips

- Power is only available at base raceway.
- Junction box at top of pole to be supplied by local electrician.
- Do not mix with Power Base (3-, 4- or 6-circuit), Power Base AI or 6-2-2 power components.

Note: Wire harness length is 180”(4572mm) regardless of pole length.

To Order, Specify:

1) Product number, including:

1 Panel Trim

A Aluminum or Wood

H Steel

2) Trim color.

| Panel Height | Pole Length | Number | Price | |
|---------------------------|--------------|----------------|-----------|-----------|
| | | | A | B |
| 12' Ceiling Height | | | | |
| 34”(864mm) - 50”(1270mm) | 119”(3023mm) | VZET-3400-4W I | \$3042.92 | \$3260.57 |
| 58”(1473mm) - 90”(2286mm) | 95”(2413mm) | VZET-6600-4W I | 2983.40 | 3154.97 |

Top Feed Harness

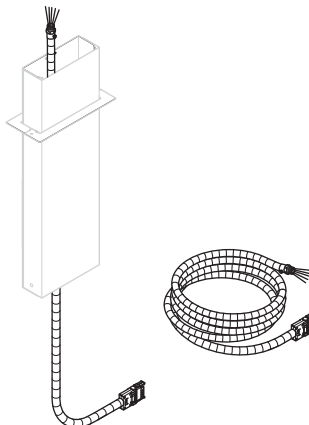

VZEH-0000-4WI
Class BC

Features

- Includes electrical harness 0.75”(19mm) galvanized metal conduit with ten 12-gauge wires for up to four circuits of power.
- For use with panels equipped with international power components.
- For ceiling height up to 12’.
- Attaches at any one of the four connector sites in a powered base raceway of a panel.

Specification Tips

- May also be used to feed power from raised floors or columns.
- Do not mix with Power Base (3-, 4- or 6-circuit), Power Base AI or 6-2-2 power components.

NOTE: Wire harness length is 180”(4572mm).

To Order, Specify:

1) Product number.
(No finish specification required.)

| Description | Harness Length | Number | Price |
|---------------|----------------|---------------|-----------|
| International | 180”(4572mm) | VZEH-0000-4WI | \$1362.56 |

Compose International — Electrical Components

Electrical Accessories

Raceway Retrofit Kit

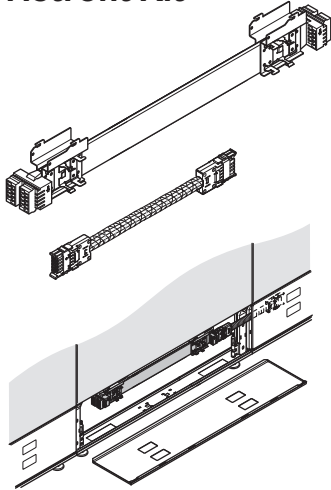

VZEP-4I
Class BC

Features

- Includes power distribution assembly (PDA), one 14"(356mm) power connector and mounting hardware.
- Converts non-powered panels to powered panels.

Specification Tips

- 8"(203mm) tiles cannot be used in place of base raceway cover.
- Field mounting of PDA is required.
- Specify raceway covers and blank plates separately.
- Do not mix with Power Base (3-, 4- or 6-circuit), Power Base AI or 6-2-2 power components.

To Order, Specify:

- 1) Product number.
- (No finish specification required.)

| Panel Width | Number | Price |
|-------------|--------------|-----------|
| 24"(610mm) | VZEP-0024-4I | \$1203.90 |
| 30"(762mm) | VZEP-0030-4I | 1226.14 |
| 36"(914mm) | VZEP-0036-4I | 1248.38 |
| 42"(1067mm) | VZEP-0042-4I | 1270.62 |
| 48"(1219mm) | VZEP-0048-4I | 1292.86 |
| 54"(1372mm) | VZEP-0054-4I | 1315.10 |
| 60"(1524mm) | VZEP-0060-4I | 1357.71 |

Raceway Covers

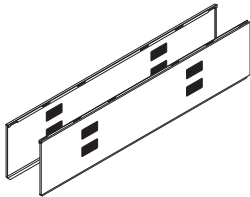

VZEK
Class BC

Features

- Includes two painted metal covers with receptacle and data openings.
- For use with panels equipped with international power components.
- Data opening is 1.38"(35mm) x 2.71"(69mm) for attachment of Modular Furniture Telecommunication Faceplates.

Specification Tips

- 8"(203mm) tiles cannot be used in place of base raceway cover.
- 18"(457mm) raceway cover has no knockouts.
- **Separately specify VZAD-0000-R to cover unused receptacle and data openings.**
- Do not mix with Power Base (3-, 4- or 6-circuit power), Power Base AI or 6-2-2 power components.

To Order, Specify:

- 1) Product number.
- 2) Trim color.

| Panel Width | Number | Price | |
|-------------|---------------|----------|-----------|
| | | A | B |
| 18"(457mm) | VZEK-OR18-NBB | \$296.24 | \$ 307.36 |
| 24"(610mm) | VZEK-OR24-6H | 620.63 | 627.09 |
| 30"(762mm) | VZEK-OR30-6H | 638.65 | 646.01 |
| 36"(914mm) | VZEK-OR36-6H | 656.67 | 664.93 |
| 42"(1067mm) | VZEK-OR42-6H | 674.69 | 683.85 |
| 48"(1219mm) | VZEK-OR48-6H | 692.71 | 702.77 |
| 54"(1372mm) | VZEK-OR54-6H | 710.73 | 721.69 |
| 60"(1524mm) | VZEK-OR60-6H | 728.75 | 740.61 |

Blank Plate

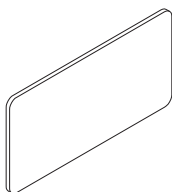

VZAD-0000-R
Class BC

Features

- Includes one cover.
- Used to cover unused 1.38"(35mm) x 2.71"(69mm) receptacle or communication openings in base raceway cover.

To Order, Specify:

- 1) Product number.
- 2) Non-metallic trim color.

| Height | Width | Number | Price |
|------------|------------|-------------|--------|
| 1.6"(41mm) | 3.1"(79mm) | VZAD-0000-R | \$5.36 |

Compose International — Electrical Components

Horizontal Power Connector – Base Raceway and Beltline Power Applications

Flexible Power Connector

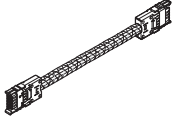

VZEF-OROP-4I
Class BC

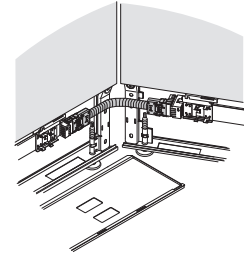
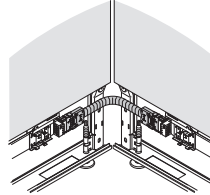
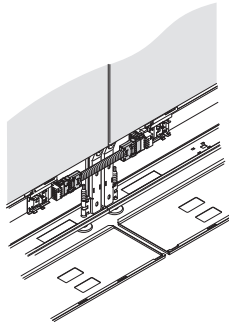

Features

- Includes one flexible power connector with safety latches for securing connector to power block.
- Continues electrical circuits between base panels in straight, 90° or 120° conditions
- For use with panels equipped with international power components.

Specification Tips

- Do not mix with Power Base (3-, 4- or 6-circuit power), Power Base AI or 6-2-2 power components.
- 14" (356mm) connector ships with each powered kit.

To Order, Specify:

- 1) Product number.
(No finish specification required.)

| Length | Number | Price |
|-------------|--------------|----------|
| 14" (356mm) | VZEF-OROP-4I | \$510.03 |

Compose International — Electrical Components

Straight-Span Flexible Power Connector

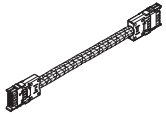

VZEF-OROS-4I
Class BC

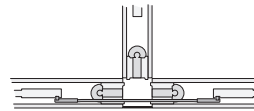
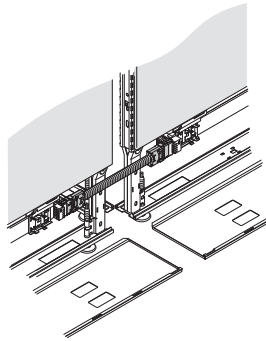

Base straight span condition

Features

- Includes one straight span flexible power connector with safety latches for securing connector to power distribution assembly.
- Continues electrical circuit across the three-inch space between base powered panels in 3-way or 4-way conditions.
- For use with panels equipped with international power components.
- May be used at the base raceway for straight span conditions.

Specification Tips

- Not for use with below worksurface, beltline or not and standing height applications.
- Straight span flexible power connector must be separately specified.
- Do not mix with Power Base (3-, 4- or 6-circuit power), Power Base AI or 6-2-2 power components.

To Order, Specify:

- 1) Product number.
(No finish specification required.)

| Length | Number | Price |
|--------------|--------------|----------|
| 16.5"(419mm) | VZEF-OROS-4I | \$510.03 |

Extended Flexible Power Connectors for Base Raceway

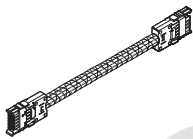

VZEJ-0018-4I
Class BC

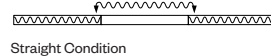
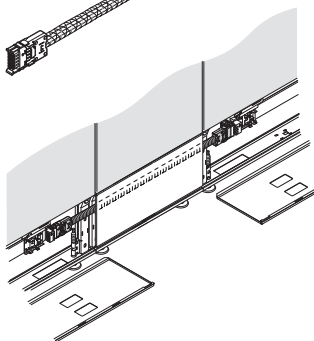

Straight Condition

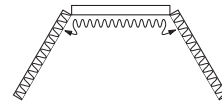

120° Condition

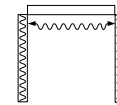

(2) 90° Conditions

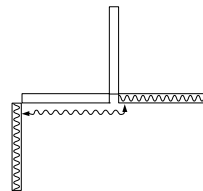

90° and 3-Way Condition

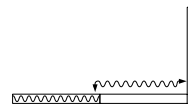

90° Condition

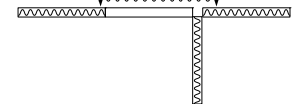

3-Way Condition

Features

- Includes one extended flexible metal power connector with safety latches.
- Spans base power through **one** 18"(457mm) non-powered panel located between two powered panels in any condition.
- For use with panels equipped with international power components.
- Extended power connectors cannot be coupled together.
- Standard in charcoal trim with metal conduit.

Specification Tips

- **Specify for use in base raceway only.**
- Not for use with hard surface tiles to the floor.
- Do not mix with Power Base (3-, 4- or 6-circuit power), Power Base AI or 6-2-2 power components.

To Order, Specify:

- 1) Product number.
(No finish specification required.)

| Panel Width | Length | Number | Price |
|-------------|------------|--------------|----------|
| 18"(457mm) | 36"(914mm) | VZEJ-0018-4I | \$318.41 |

Compose International — Electrical Components

Receptacles

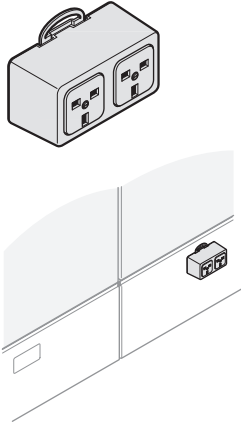

VNER
Class FA

Features

- Includes box of three receptables.
- For use with International power components.
- Receptacles are circuit and ground type specific.
- Standard in black trim color only.

Specification Tips

- Receptacles have fixed circuit access and are not field programmable. Specify appropriate number of receptacles for each circuit.
- For power access at base location with panels equipped with appropriate base raceway covers.
- Do not mix with Power Base (3-, 4-, or 6-circuit power), Power Base AI or 6-2-2 components.

To Order, Specify:

- 1) Product number.
(No finish specification required.)

| Description | Ground Type | Circuit Access | Number | Price |
|-------------|-------------|----------------|----------------|------------|
| Australian | Common | Circuit 1 | VNER-1500-M14A | \$ 1065.71 |
| | | Circuit 2 | VNER-1500-M24A | 1065.71 |
| | | Circuit 3 | VNER-1500-M34A | 1065.71 |
| | | Circuit 4 | VNER-1500-M44A | 1065.71 |
| | Isolated | Circuit 1 | VNER-1500-I14A | 1096.09 |
| | | Circuit 2 | VNER-1500-I24A | 1096.09 |
| | | Circuit 3 | VNER-1500-I34A | 1096.09 |
| | | Circuit 4 | VNER-1500-I44A | 1096.09 |
| British | Common | Circuit 1 | VNER-1500-M14B | \$ 1065.71 |
| | | Circuit 2 | VNER-1500-M24B | 1065.71 |
| | | Circuit 3 | VNER-1500-M34B | 1065.71 |
| | | Circuit 4 | VNER-1500-M44B | 1065.71 |
| | Isolated | Circuit 1 | VNER-1500-I14B | 1096.09 |
| | | Circuit 2 | VNER-1500-I24B | 1096.09 |
| | | Circuit 3 | VNER-1500-I34B | 1096.09 |
| | | Circuit 4 | VNER-1500-I44B | 1096.09 |
| French | Common | Circuit 1 | VNER-1500-M14F | \$ 1065.71 |
| | | Circuit 2 | VNER-1500-M24F | 1065.71 |
| | | Circuit 3 | VNER-1500-M34F | 1065.71 |
| | | Circuit 4 | VNER-1500-M44F | 1065.71 |
| | Isolated | Circuit 1 | VNER-1500-I14F | 1096.09 |
| | | Circuit 2 | VNER-1500-I24F | 1096.09 |
| | | Circuit 3 | VNER-1500-I34F | 1096.09 |
| | | Circuit 4 | VNER-1500-I44F | 1096.09 |

Compose International — Electrical Components

Receptacles

| Description | Ground Type | Circuit Access | Number | Price |
|-------------|-------------|----------------|----------------|------------|
| Italian | Common | Circuit 1 | VNER-1500-M14I | \$ 1065.71 |
| | | Circuit 2 | VNER-1500-M24I | 1065.71 |
| | | Circuit 3 | VNER-1500-M34I | 1065.71 |
| | | Circuit 4 | VNER-1500-M44I | 1065.71 |
| | Isolated | Circuit 1 | VNER-1500-I14I | 1096.09 |
| | | Circuit 2 | VNER-1500-I24I | 1096.09 |
| | | Circuit 3 | VNER-1500-I34I | 1096.09 |
| | | Circuit 4 | VNER-1500-I44I | 1096.09 |
| Schuko | Common | Circuit 1 | VNER-1500-M14S | \$ 1065.71 |
| | | Circuit 2 | VNER-1500-M24S | 1065.71 |
| | | Circuit 3 | VNER-1500-M34S | 1065.71 |
| | | Circuit 4 | VNER-1500-M44S | 1065.71 |
| | Isolated | Circuit 1 | VNER-1500-I14S | 1096.09 |
| | | Circuit 2 | VNER-1500-I24S | 1096.09 |
| | | Circuit 3 | VNER-1500-I34S | 1096.09 |
| | | Circuit 4 | VNER-1500-I44S | 1096.09 |
| Swiss | Common | Circuit 1 | VNER-1500-M14W | \$ 1065.71 |
| | | Circuit 2 | VNER-1500-M24W | 1065.71 |
| | | Circuit 3 | VNER-1500-M34W | 1065.71 |
| | | Circuit 4 | VNER-1500-M44W | 1065.71 |
| | Isolated | Circuit 1 | VNER-1500-I14W | 1096.09 |
| | | Circuit 2 | VNER-1500-I24W | 1096.09 |
| | | Circuit 3 | VNER-1500-I34W | 1096.09 |
| | | Circuit 4 | VNER-1500-I44W | 1096.09 |
| NEMA 6-20R | Common | Circuit 1 | VNER-2000-M146 | \$ 1114.80 |
| | | Circuit 2 | VNER-2000-M246 | 1114.80 |
| | | Circuit 3 | VNER-2000-M346 | 1114.80 |
| | | Circuit 4 | VNER-2000-M446 | 1114.80 |
| | Isolated | Circuit 1 | VNER-2000-I146 | 1141.13 |
| | | Circuit 2 | VNER-2000-I246 | 1141.13 |
| | | Circuit 3 | VNER-2000-I346 | 1141.13 |
| | | Circuit 4 | VNER-2000-I446 | 1141.13 |

10 Wire Power Resources

Index

Warranty/Terms of Sale

Index

Products are listed alphabetically in this index by alpha-numeric prefix/suffix codes.

| Product Code | Product Description | Page |
|---------------------|---|-------------|
| EUEH | Compose 4-4-2 — Electrical Components – Belong Infeed Harness | .15 |
| EUEJ | Compose 4-4-2 — Electrical Components – Belong Jumper | .15 |
| VNER | Compose International — Electrical Components – Receptacles | .34 |
| VZAD-0000-R | Compose 4-4-2 — Electrical Components – Blank Plate | .13 |
| VZAD-0000-R | Compose 6-2-2 — Electrical Components – Blank Plate | .22 |
| VZAD-0000-R | Compose International — Electrical Components – Blank Plate | .31 |
| VZEB-0000-4I | Compose 4-4-2 — Electrical Components – Base Feed Module – Hardwire Connection | .11 |
| VZEB-0000-4I | Compose International — Electrical Components – Base Feed Module – Hardwire Connection | .29 |
| VZEB-0000-6 | Compose 6-2-2 — Electrical Components – Base Feed Module – Hardwire Connection | .20 |
| VZEF-OROP-4I | Compose 4-4-2 — Electrical Components – Flexible Power Connector | .14 |
| VZEF-OROP-4I | Compose International — Electrical Components – Flexible Power Connector | .32 |
| VZEF-OROP-6 | Compose 6-2-2 — Electrical Components – Flexible Power Connector | .23 |
| VZEF-OROS-4I | Compose 4-4-2 — Electrical Components – Flexible Power Connector – Straight Span, Raceway | .16 |
| VZEF-OROS-4I | Compose International — Electrical Components – Straight-Span Flexible Power Connector | .33 |
| VZEF-OROS-6 | Compose 6-2-2 — Electrical Components – Flexible Power Connector – Straight Span, Raceway | .24 |
| VZEH-0000-4WI | Compose 4-4-2 — Electrical Components – Top Feed Harness | .12 |
| VZEH-0000-4WI | Compose International — Electrical Components – Top Feed Harness | .30 |
| VZEH-0000-6W | Compose 6-2-2 — Electrical Components – Top Feed Harness | .21 |
| VZEJ-0018-4I | Compose 4-4-2 — Electrical Components – Extended Flexible Power Connectors for Base Raceway | .16 |
| VZEJ-0018-4I | Compose International — Electrical Components – Extended Flexible Power Connectors for Base Raceway | .33 |
| VZEJ-0018-6 | Compose 6-2-2 — Electrical Components – Extended Flexible Power Connectors for Base Raceway | .24 |
| VZEK | Compose 4-4-2 — Electrical Components – Raceway Covers | .13 |
| VZEK | Compose 6-2-2 — Electrical Components – Raceway Covers | .22 |
| VZEK | Compose International — Electrical Components – Raceway Covers | .31 |
| VZEP-4I | Compose 4-4-2 — Electrical Components – Raceway Retrofit Kit | .13 |
| VZEP-4I | Compose International — Electrical Components – Raceway Retrofit Kit | .31 |
| VZEP-6 | Compose 6-2-2 — Electrical Components – Raceway Retrofit Kit | .22 |
| VZER-1500 | Compose 4-4-2 — Electrical Components – Receptacles | .17 |
| VZER-1500 | Compose 6-2-2 — Electrical Components – Receptacles | .25 |
| VZET-4WI | Compose 4-4-2 — Electrical Components – Top Feed Module | .12 |
| VZET-4WI | Compose International — Electrical Components – Top Feed Module | .30 |
| VZET-6W | Compose 6-2-2 — Electrical Components – Top Feed Module | .21 |

Product Compatibility and Limited Warranty Policy

Great Expectations

You have them as a Haworth customer and so do we. And because we value our customers, we cover our products with the Haworth North America Product Compatibility and Limited Warranty Policy.

Our Commitment To Product Compatibility – Integrated Product Platforms

As a market leader in the design and manufacture of workspaces that adapt to change, we strive to maintain product compatibility within our various generations of integrated product platforms. This benefits the customer who desires to update or modify their work environment. It also benefits the customer needing to replace a product due to damage or other reasons but which is no longer manufactured or is otherwise unavailable, such as a fabric or finish that is discontinued because of changing market preferences. In both circumstances, we often can provide products with comparable function and performance.

Our Commitment To Product Quality – The Haworth North America Limited Warranty

To ensure customer satisfaction and peace of mind, we stand behind our products with the Haworth North America Limited Warranty. To review the current version of the limited warranty including its terms and conditions, please go to:

www.haworth.com/warranty or contact OneTouch@Haworth.com or 1 877 429 6784.

Warranty Requests or Questions

For questions or service requests pertaining to the Haworth Limited Warranty, please contact your Haworth dealer.

If you are unsure who your dealer is, please contact **OneTouch@Haworth.com or 1 877 429 6784.**

Terms of Sale

The Terms of Sale apply to all products in the North America Price Lists. To review the current version of the North American Terms of Sale, please go to:

www.haworth.com/terms-of-sale or contact OneTouch@Haworth.com or 1 877 429 6784.

HAWORTH

HAWORTH® is a registered trademark of Haworth, Inc.

© Haworth, Inc. All rights reserved. 2025 8.25

haworth.com | 800 344 2600