

Haworth Price Adjustment

A non-discountable 1.75% increase to list price will be applied to all orders placed after April 07, 2025

Masters Series

GSA Price List – March 2025



This price list is based upon Haworth's February 2025 commercial pricing.
GENERAL SERVICES ADMINISTRATION FEDERAL SUPPLY SERVICE
Authorized Federal Supply Scheduled Price List (Catalog) Office Furniture, Wood Casegoods and Tables
(FSC Group 71, Part I, FSC Classes 7105, 7110, 7125 and 7195)
Contract No: GS-03F-057DA | Contract Period: February 8, 2016 – February 7, 2026 | Business: Large
Contractor: Haworth, Inc. | One Haworth Center | Holland, MI 49423-9576 | 1.616.393.3000



Electronic Update Page – Masters Series Price Book

- The table below lists all of the updates and addendums added to this price list since the original version was created.
- All **Update** pages will replace the existing pages within the document.
- All **New** pages will be placed at the back of the document.

Link	Date	Pages	Description
Click Here	April 2025	All Price List Pages	Update – Pricing Surcharge – effective April 7, 2025 all future orders will have a non-discountable 1.75% of list price surcharge added.
Click Here	May 2025	20, 29-31, 35, 39-40, 202, 207-212, 217-219	Update – Chrome finish for Masters Leg/Column has been discontinued.
Click Here	May 2025	22, 24, 26, 29, 30, 31, 36, 38	Update – Discontinued edge options removed from pricing chart.
Click Here	May 2025	41	Update – Added Options to the pricing numbers
Click Here	May 2025	130, 131	Update – Actual dimensions for the top width were updated.
Click Here	May 2025	127	Update – Specification Tip copy was updated.
Click Here	May 2025	165, 170	Update – Illustration correction for adjustable shelf locations.
Click Here	May 2025	176, 178, 180	Update – Correction to the number of file bars from two to one.
Click Here	May 2025	193	Update – Pull finish added.



This Haworth North American price book contains US list prices.

Canadian customers can convert the US list price into their Canadian equivalent by going to www.Haworth.com/Canada to find the current Canadian multipliers. These multiplier factors allow you to convert the US list price into a Canadian list price.

HAWORTH, INC.

GENERAL SERVICES ADMINISTRATION

FEDERAL ACQUISITION SERVICES

Authorized Federal Supply Schedule Furniture (FSC Group 71, FSC Classes 7105, 7110, 7125 and 7195)

Contract Number:	GS-03F-057DA
Contract Start Date:	February 8, 2016
Contract End Date:	February 7, 2026
Contractor:	HAWORTH, INC. One Haworth Center Holland, MI 49423-9576 1-616-393-3000 http://www.haworth.com/government
Business Size:	Large

Information for Ordering Activities I-FSS-600

Online access to Haworth's Authorized Federal Supply Schedule contract ordering information, terms and conditions, and up-to-date product and discount listing can be found at GSA Advantage, eLibrary link [here](#).

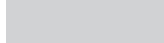

This Page Intentionally Left Blank

Masters Series Price List

Includes pricing, catalog numbers, finish codes/availability, specification requirements, line art, dimensions, and specification tips for Masters Series.

Desks

Upper Storage

Stack-On Storage

Reception Stations

Modular Components

Storage

Tables

Accessories

Table of Contents

Price List

Statement of Line	7
Catalog Logic	14
Desks	
Single Pedestal Desk — Full Overlay Modesty	15
Double Pedestal Desk — Full Overlay Modesty	17
Desk Shell	19
Table Desk — Hoop Leg	20
Height Adjustable Table Desk — T-Leg Base	21
Height Adjustable Convergent Worktop — Rectangular — T-Leg	23
Height Adjustable Convergent Worktop — Wedge Square— T-Leg	25
Height Adjustable Convergent Worktop — Wedge Radius — T-Leg	27
Convergent Worktop for use with 1.5H Storage — Rectangular with Column or Hoop	29
Convergent Worktop for use with 1.5H Storage — Wedge Square with Column or Hoop	30
Convergent Worktop for use with 1.5H Storage — Wedge Radius with Column or Hoop	31
Shroud — Use with Height Adjustable T-Leg	32
Modesty Panel — Use with Shroud	33
Convergent T-Worktop	34
Convergent D-Worktop — T-Support and Column	35
Convergent P-Worktop — T-Support and Column	37
Convergent D-Worktop — Column	39
Convergent P-Worktop — Column	40
Bridge	41
Corner Shell	43
Return Top	44
Height Adjustable Credenza Desk — T-Leg Base	45
Vertical Storage Unit	
1H Open	47
2H Open	49
1H Hinged Doors	51
2H Hinged Doors	53
1H Sliding Door	55
2H Sliding Door	57
1H Glass Hinged Doors	59
2H Glass Hinged Doors	61
1H Glass Sliding Door	63
2H Glass Sliding Door	65
Tackboard — Fabric	67
Tackboard — Fabric and Slat Rail	67
Wall Mount Open Sided Shelf	68
Wall Mount L Shelf	75
Wall Mount Floating Metal Shelf	78
Wall Mount Tile Kit	79
Wall Mount Frameless Glass Tile	82
Wall Mount Tackboard — For Overhead Storage Units — Fabric	84
Wall Mount Tackboard — For Overhead Storage Units — Fabric and Slat Rail	85
Stretch and Pull Information	86
Tackboard Size Chart — For Use with Standard Wall Mount Storage Components	87
Wall Mount Spacers	88
Wall Mount Vertical Filler Trim	89
Overhead Storage Unit	
1H Open	90
2H Open	92
1H Hinged Doors	94
1.5H Hinged Doors	96
2H Hinged Doors	98
1H Sliding Door	100
1.5H Sliding Door	102
2H Sliding Door	104
1H Glass Hinged Doors	106
1.5H Glass Hinged Doors	108
2H Glass Hinged Doors	110
1H Glass Sliding Door	112
1.5H Glass Sliding Door	114
2H Glass Sliding Door	116
Mounting Bracket to Enclose	118

Stack-On Storage	
Stack-On Bookcase	119
Stack-On Storage Cabinet — Hinged Doors	121
Stack-On Storage Cabinet — Glass Doors	123
Reception Stations	
L-Shaped	125
U-Shaped	126
Modular Components	
Storage Top	127
Bookcase Top	128
Credenza Top	129
Full-Overlay Modesty Panel	132
Hinged Modesty Panel	133
Adaptable Hinged Modesty Panel	134
2H End Panel	137
L-Support Panel	138
2H Partial Depth L-Support Panel	140
T-Support Panel	141
2H Support Panel	142
Mid-Support Panel	142
Storage	
Pedestal — Attached	143
Pedestal — Mobile	145
Storage Cushion	146
Lateral File — Attached Open Shelf	147
Lateral File — Attached	149
Storage Unit — Attached	151
Storage Unit — 1.5H Attached Open for use with Convergent Worktop	153
Storage Unit — 1.5 or 2H Doors	154
Storage Unit — 1.5H Attached Sliding Door — 18" Depth	156
Storage Unit — 2H Attached Sliding Door — 18" Depth	158
Storage Unit — 1.5H Attached Sliding Door — 23" Depth	160
Storage Unit — 2H Attached Sliding Door — 23" Depth	162
Storage Unit — 3H Freestanding Open	164
Storage Unit — 3H Freestanding with Hinged Doors	165
Lateral File — 3H and 4H Freestanding	166
Lateral File — 5H and 6H Freestanding	168
Lateral File — 5H and 6H Combination Unit	170
Wardrobe — 5H and 6H Open Unit	172
Wardrobe — 5H and 6H Closed Storage Unit	174
Personal Storage Tower — 5H and 6H F/F/F Pedestal and Valet	176
Personal Storage Tower — 5H and 6H F/F Pedestal and Valet	178
Storage Tower — 5H and 6H	180
Wardrobe — 5H and 6H	182
Wardrobe — Fixed Boot Shelf	184
Bookcase	185
Tables	
Round	187
Accessories	
Counterweight	188
Flush Mount Plate	188
Tetra Bracket	188
Center Drawer	189
Pencil Tray	189
File Bars	189
Grommet	190
Column Base	190
Resources	
Surface Materials	
Wood Finish/Color Legend	192
Finish Color Legend	193
Fabrics/Color Legend	194
COM Yardage Requirements	
Masters Series Tackboard Fabric Usage	195
Index	197-204
Lifetime Product Warranty	205

Statement of Line

Desks

Pages 15-46

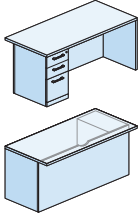

Single Pedestal Desk with Full Overlay

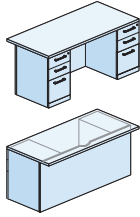

Double Pedestal Desk with Full Overlay Modesty

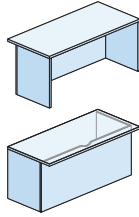

Desk Shell

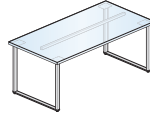
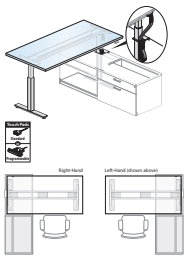

Table Desk Hoop Leg



Height Adjustable Table Desk T-Leg Base



Height Adjustable Convergent Worktop Rectangular T-Leg

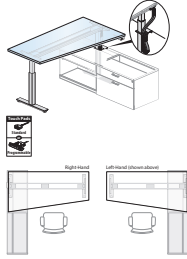

Height Adjustable Convergent Worktop Wedge Square T-Leg

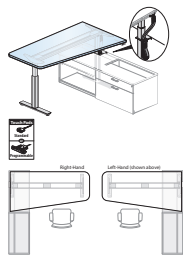

Height Adjustable Convergent Worktop Wedge Radius T-Leg

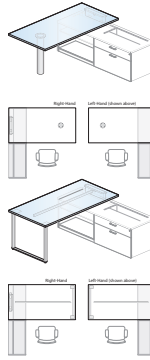

Convergent Worktop for use with 1.5H Storage Rectangular with Column or Hoop

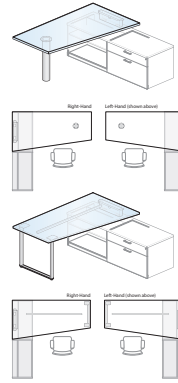

Convergent Worktop for use with 1.5H Storage Wedge Square with Column or Hoop

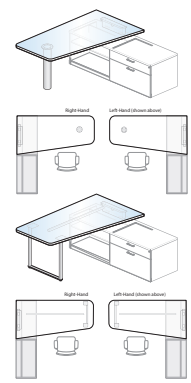

Convergent Worktop for use with 1.5H Storage Wedge Radius with Column or Hoop

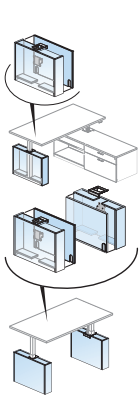

Shroud use with Height Adjustable T-Leg

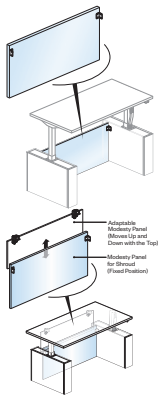

Modesty Panel use with Shroud

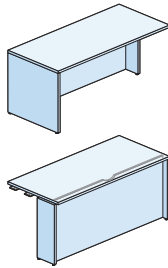

Convergent T-Worktop

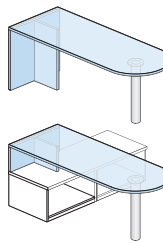

Convergent D-Worktop with T-Support and Column

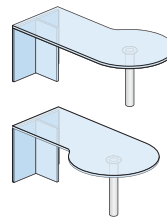

Convergent P-Worktop with T-Support and Column

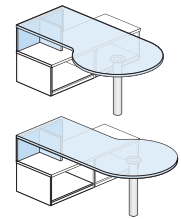

Convergent P-Worktop with T-Support and Column

Statement of Line

Desks (cont'd)

Pages 15-46

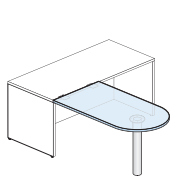

Convergent D-Worktop with Column

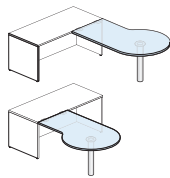

Convergent P-Worktop with Column

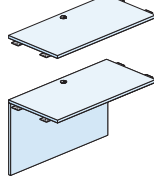

Bridge

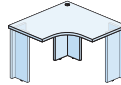

Corner Shell

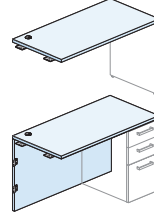

Return Top



Without Shrouds or Modesty

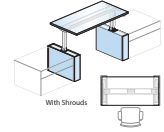

With Shrouds

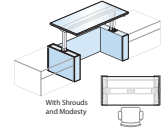

With Shrouds and Modesty

Height Adjustable Credenza Desk T-Leg Base

Upper Storage

Pages 47-118

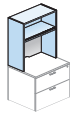

1H Vertical Storage Units Open

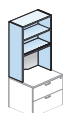

2H Vertical Storage Units Open

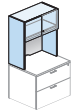

1H Vertical Storage Units with Hinged Doors

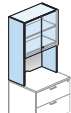

2H Vertical Storage Units with Hinged Doors

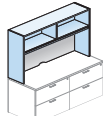

1H Vertical Storage Units with Sliding Door

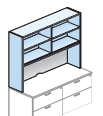

2H Vertical Storage Units with Sliding Door

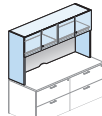

1H Vertical Storage Units with Glass Hinged Doors

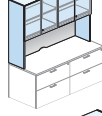

2H Vertical Storage Units with Glass Hinged Doors

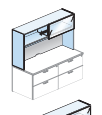
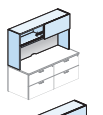

1H Vertical Storage Units with Glass Sliding Door

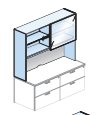

2H Vertical Storage Units with Glass Sliding Door

Statement of Line

Upper Storage (cont'd)

Pages 47-118

Tackboards for Vertical Storage Units Fabric

Tackboards for Vertical Storage Units Fabric and Slat Rail

Wall Mount Open Sided Shelf

Wall Mount L Shelf

Wall Mount Floating Metal Shelves

Wall Mount Tile Kit

Wall Mount Frameless Glass Tile

Wall Mount Tackboards for Overhead Storage Units Fabric

Wall Mount Tackboards for Overhead Storage Units Fabric and Slat Rail

Wall Mount Spacers

Wall Mount Vertical Filler Trim

1H Overhead Storage Units Open

2H Overhead Storage Units Open

1H Overhead Storage Units with Hinged Doors

1.5H Overhead Storage Units with Hinged Doors

2H Overhead Storage Units with Hinged Doors

1H Overhead Storage Units with Sliding Door

(3) Depths: Shelves & Wall Mnt. Tiles
Tackboard
Frameless Glass
French Cleat

22" - 53" High
Frameless Glass Tiles

Over 22" up to 53"
1/8" Thickened

Statement of Line

Upper Storage (cont'd)

Pages 47-118

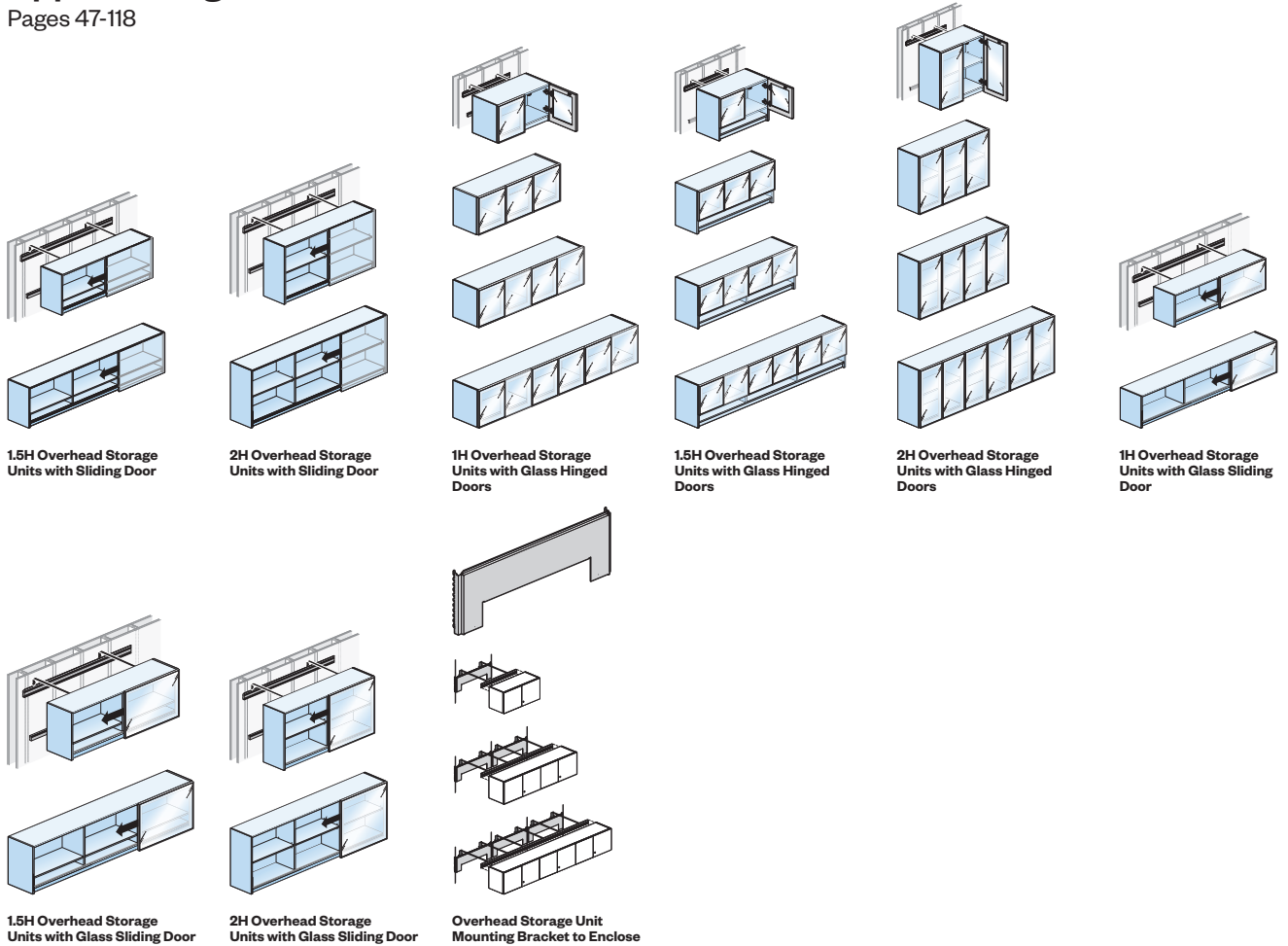

Stack-On Storage

Pages 119-123

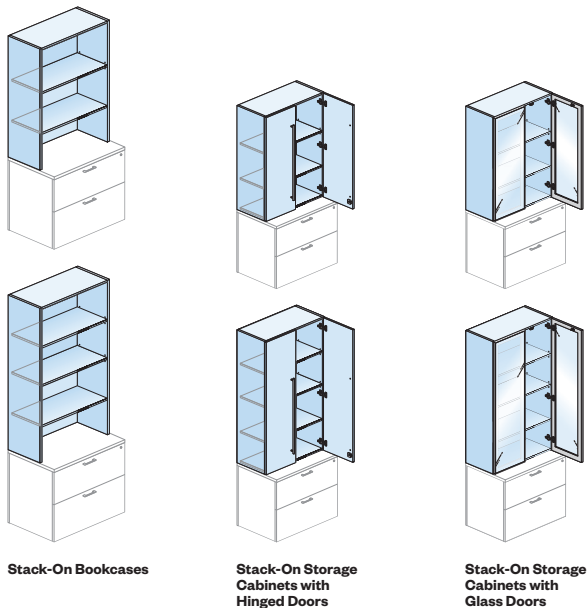

Statement of Line

Reception Stations

Pages 125-126

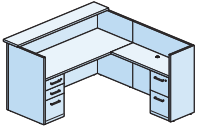

L-Shaped Reception Stations

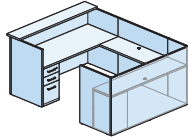

U-Shaped Reception Stations

Modular Components

Pages 127-142

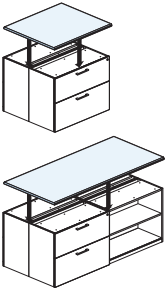

Storage Top

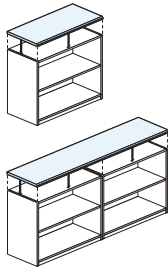

Bookcase Top

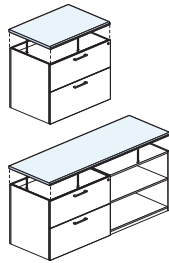

Credenza Top

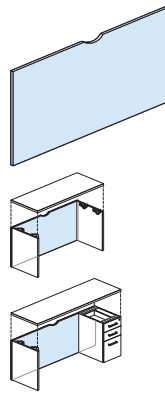

Full-Overlay Modesty Panel

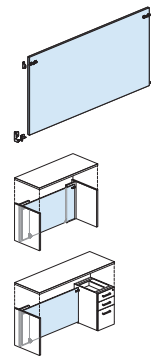

Hinged Modesty Panel

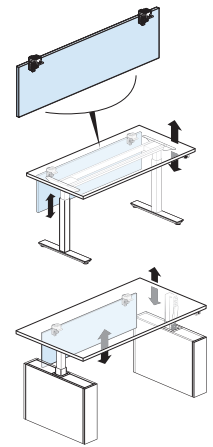

Adaptable Modesty Panel

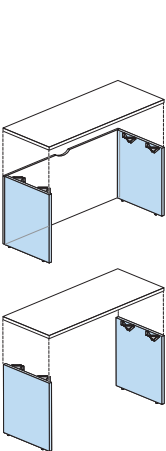

2H End Panel

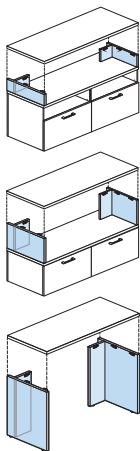

L-Support Panel

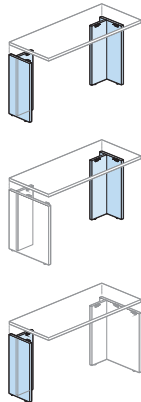

2H Partial Depth L-Support Panel

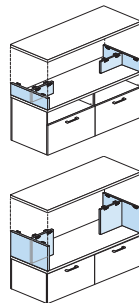

T-Support Panel

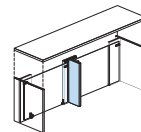

2H T-Support Panel

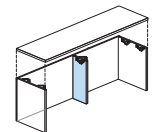

2H Mid-Support Panel

Statement of Line

Storage

Pages 143-185

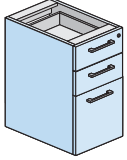

Attached Pedestals

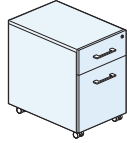
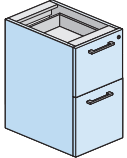

Mobile Pedestals

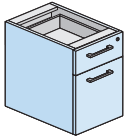

Storage Cushion

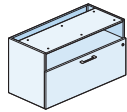

Attached Lateral File with Open Shelf

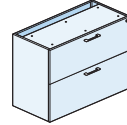
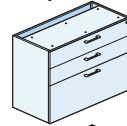
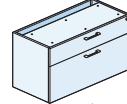
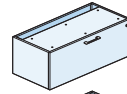

Attached Lateral Files

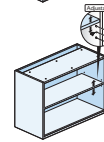
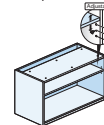
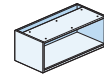

Attached Storage Units

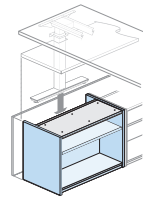

1.5H Attached Storage for use with Convergent Worktop Open Unit

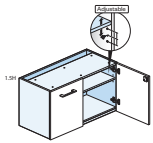

1.5 or 2H Doors Storage Unit

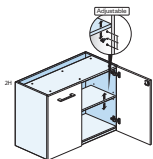

1.5H Attached Sliding Door - 18" Depth Storage Unit

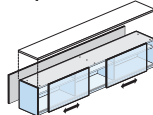

2H Attached Sliding Door - 18" Depth Storage Unit

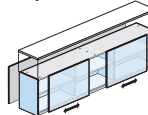

1.5H Attached Sliding Door - 23" Depth Storage Unit

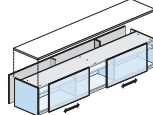

2H Attached Sliding Door - 23" Depth Storage Unit

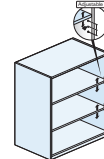
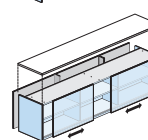

3H Freestanding Open Storage Unit

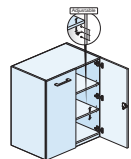

3H Freestanding Storage Unit with Hinged Doors

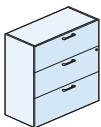

3H Freestanding Lateral File

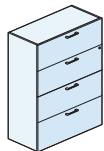

4H Freestanding Lateral File

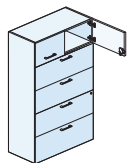

5H Freestanding Lateral File

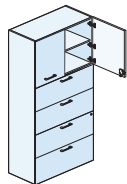

6H Freestanding Lateral File

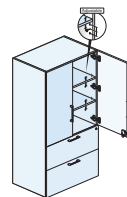

5H Combination Units with Lateral File

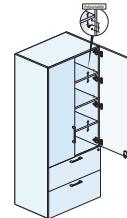

6H Combination Units with Lateral File

Statement of Line

Storage (cont'd)

Pages 143-185

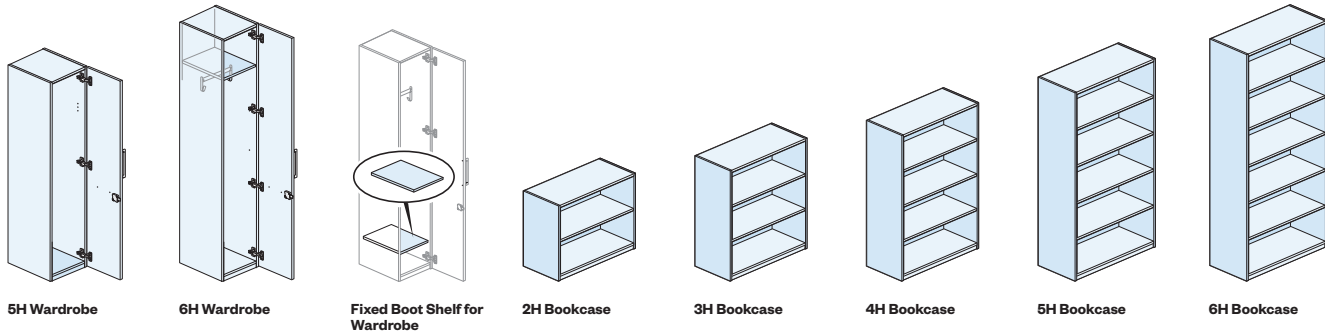
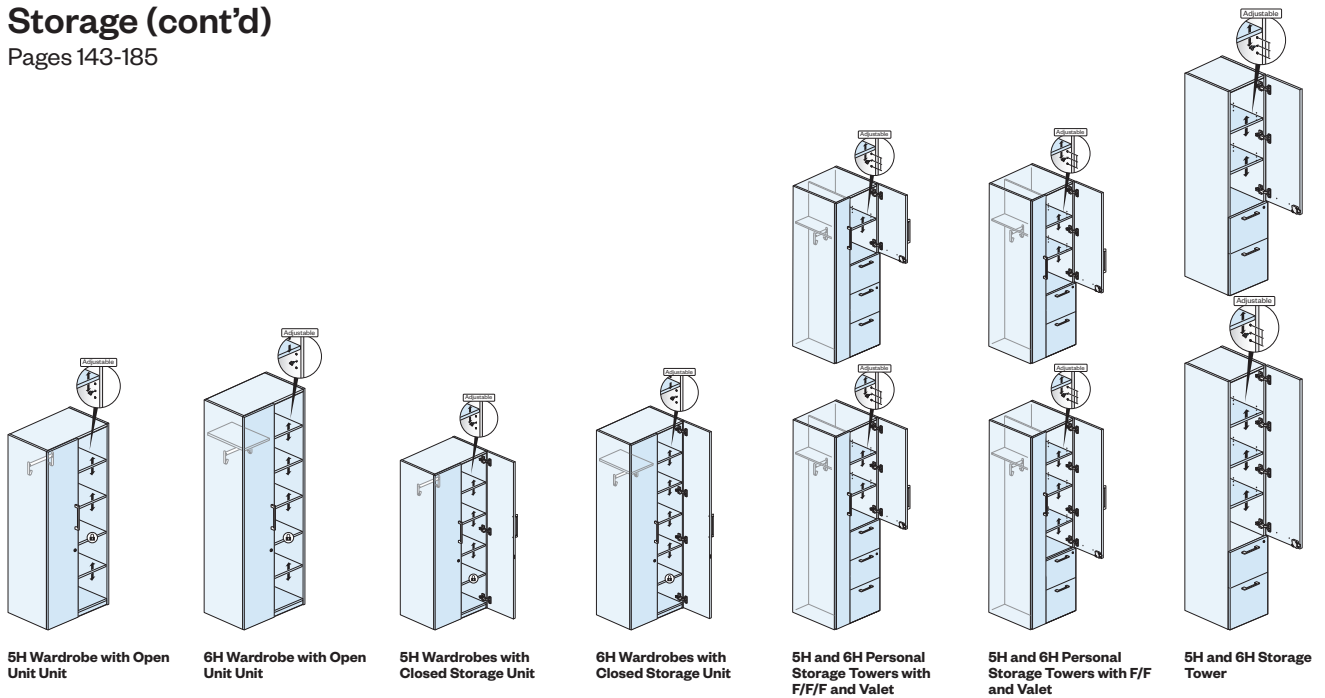

Tables

Page 187



Round

Accessories

Pages 188-190

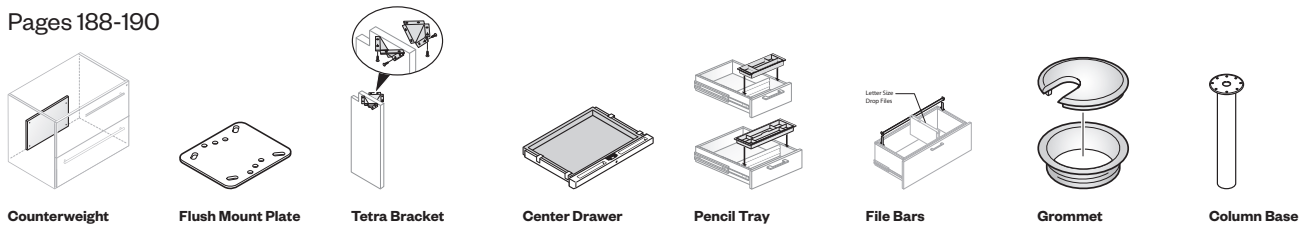

Masters Series

Catalog Logic

X Z S F - 30 60 - 1 S S 5N F W F

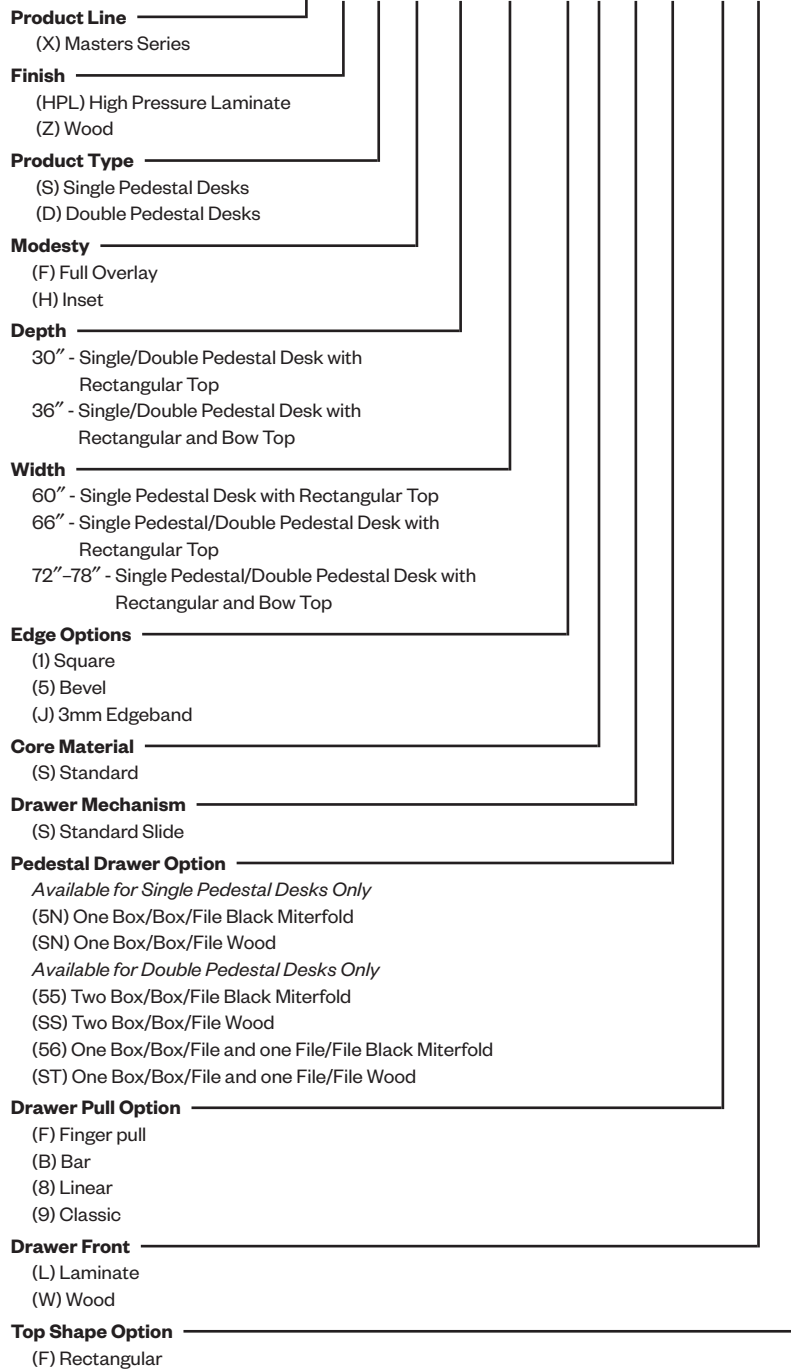

Single Pedestal Desk

Full Overlay Modesty

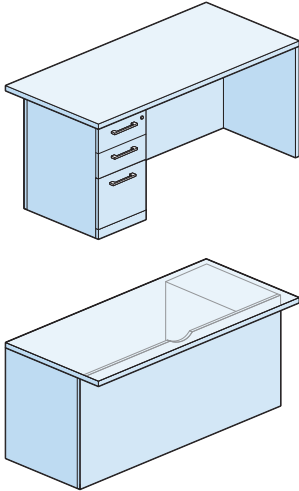

XLSF-LF
XZSF-WF
Class RA

Features

- Includes worksurface, case and one pedestal.
- 1.18" (30mm) thick high-pressure laminate (HPL) worksurface with 3mm edgeband applied to user and visitor edges only. Ends capped with 1mm thick edgeband. All other components finished in laminate with 1mm thick edgeband.
- 1.18" (30mm) thick Wood worksurface with a choice of profiled edge (Square or Bevel) applied to user and visitor edges. Double-cut veneers available with Square 3mm Radius edge only.
- Full-overlay modesty panel recessed 6" (152mm) for visitor side overhang.
- Unfinished clearcoat wireway scallop in top center of modesty panel.
- Letter width 15.5" (394mm) pedestal.
- Box drawer with one black drawer divider per drawer and one black pencil tray per pedestal.
- File drawer with an integrated file hanging system.
- Drawer pull options:
 - Bar pulls available in powdercoat finishes.
 - Linear pulls available in both powdercoat and satin nickel finish. Satin nickel will need to be specified.
 - Classic pulls are available in brushed nickel finish only. Finish code not required.
 - Finger pull option, available with Walnut double cut and Wood Group B finishes, indicates a drawer with a touch latch.
- Box and file drawers have full extension slides.
- One lock standard per pedestal.
- Lock plug is available in black or chrome.
- For lock options, refer to Lock Program section of the Accessories Price List.
- Glides provide 2" (51mm) adjustment range.
- Desk shell shipped unassembled, pedestals shipped assembled ready for field installation.

Specification Tips

- Non-handed design, allows pedestal location to be determined on site.
- Not for use with a Vertical Storage Unit.
- Accommodates separately specified center drawer.
- See Stack-on Application Rules for upper storage requirements.
- May be used as a freestanding/standalone desk or with separately specified attached modular components to design an L- or U-shaped application. See the Specification Guide for application guidelines.
- Separately specified grommets can be field installed in desk worksurface.

To Order, Specify:

1) Product number, including:

1 Edge Option:

Wood:

- 1** Square
- 5** Bevel (add **\$195.85*** list)

2 Pedestal Drawer Option:

- 5** Box/Box/File Black Miterfold
- S** Box/Box/File Wood (add **\$154.50** list)

3 Drawer Pull Option**:

- F** Finger pull (wood only) (add **\$160.00** list)
- B** Bar (add **\$85.00** list)
- 8** Linear
- 9** Classic (add **\$30.00** list)

2) Finish code (laminate or wood).

3) Laminate edge trim for lower components (if laminate specified).

4) Laminate worksurface color (if laminate option specified).

5) Laminate edge trim for worksurface (if laminate option specified).

6) Trim color for painted pull (if specified).

7) Trim color for lock (required).

Note: Wood grained laminate worksurface finishes are applied with wood grain direction side-to-side only.

*Additional upcharge based on size. Use design and specification tools for pricing.

**Price per pull.

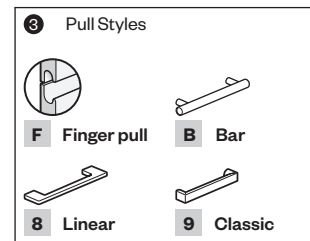

Single Pedestal Desk

Full Overlay Modesty

Height	Depth	Width	Number ① ② ③	HPL		Wood	
				A	B	A	B
HPL							
29.125"(740mm)	30"(762mm)	60"(1524mm)	XLSF-3060-JSS █ N █ LF	\$ 2551.98	\$ 2612.73		
		66"(1676mm)	XLSF-3066-JSS █ N █ LF	2588.93	2652.58		
		72"(1829mm)	XLSF-3072-JSS █ N █ LF	2625.88	2692.43		
		78"(1981mm)	XLSF-3078-JSS █ N █ LF	2662.83	2732.28		
	36"(914mm)	66"(1676mm)	XLSF-3666-JSS █ N █ LF	\$2670.22	\$2740.25		
		72"(1829mm)	XLSF-3672-JSS █ N █ LF	2714.56	2788.07		
		78"(1981mm)	XLSF-3678-JSS █ N █ LF	2758.90	2835.89		
Wood							
29.125"(740mm)	30"(762mm)	60"(1524mm)	XZSF-3060- █ SS █ N █ WF			\$ 3982.90	\$4388.15
		66"(1676mm)	XZSF-3066- █ SS █ N █ WF			4057.50	4470.20
		72"(1829mm)	XZSF-3072- █ SS █ N █ WF			4132.10	4552.25
		78"(1981mm)	XZSF-3078- █ SS █ N █ WF			4206.70	4634.30
	36"(914mm)	66"(1676mm)	XZSF-3666- █ SS █ N █ WF			\$ 4221.62	\$4650.71
		72"(1829mm)	XZSF-3672- █ SS █ N █ WF			4311.14	4749.17
		78"(1981mm)	XZSF-3678- █ SS █ N █ WF			4400.66	4847.63

Double Pedestal Desk

Full Overlay Modesty

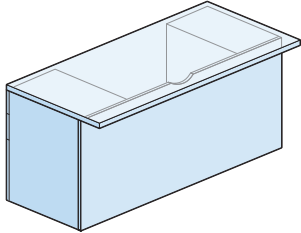
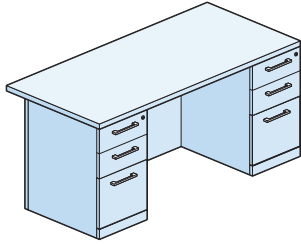

XLDF-LF
XZDF-WF
Class RA

Features

- Includes worksurface, case and two pedestals.
- 1.18" (30mm) thick high-pressure laminate (HPL) worksurface with 3mm edgeband applied to user and visitor edges only. Ends capped with 1mm thick edgeband. All other components finished in laminate with 1mm thick edgeband.
- 1.1875" (30mm) thick Wood worksurface with a choice of profiled edge (Square or Bevel) applied to user and visitor edges. Double-cut veneers available with Square 3mm Radius edge only.
- Full-overlay modesty panel recessed 6" (152mm) for visitor side overhang.
- Unfinished clearcoat wireway scallop in top center of modesty panel.
- Choice of two Box/Box/File pedestals or one Box/Box/File and one File/File pedestal.
- Letter width 15.5" (394mm) pedestals.
- Box drawer with one black drawer divider per drawer and one black pencil tray per pedestal.
- File drawer with an integrated file hanging system.
- Drawer pull options:
 - Bar pulls available in powdercoat finish.
 - Linear pulls available in both powdercoat and satin nickel finish. Satin nickel will need to be specified.
 - Classic pulls are available in brushed nickel finish only. Finish code not required.
 - Finger pull option, available with Walnut double cut and Wood Group B finishes, indicates a drawer with a touch latch.
- Box and file drawers have full extension slides.
- One lock standard per pedestal; each pedestal locks separately.
- Common keys within each desk.
- Lock plug is available in black or chrome.
- For lock options, refer to Lock Program section of the Accessories Price List.
- Glides provide 2" (51mm) adjustment range.
- Desk shell shipped unassembled, pedestals shipped assembled ready for field installation.

Specification Tips

- Non-handed design, allows pedestal location to be determined on site.
- Accommodates separately specified center drawer.
- For use as a freestanding/standalone desk; not for use with attached modular components.
- Not intended to be used with stack-on storage.
- Separately specified grommets can be field installed in desk worksurface.

To Order, Specify:

1) Product number, including:

1 Edge Option:

Wood:

- 1** Square
- 5** Bevel (add **\$262.70*** list)

2 Pedestal Drawer Option:

- 55** Two Box/Box/File Black Miterfold
- SS** Two Box/Box/File Wood (add **\$309.00** list)
- 56** One Box/Box/File and One File/File Black Miterfold
- ST** One Box/Box/File and One File/File Wood (add **\$321.41** list)

3 Drawer Pull Option**:

- F** Finger pull (wood only) (add **\$160.00** list)
- B** Bar (add **\$85.00** list)
- 8** Linear
- 9** Classic (add **\$30.00** list)

- 2) Finish code (laminate or wood).
- 3) Laminate edge trim for lower components (if laminate specified).
- 4) Laminate worksurface color (if laminate option specified).
- 5) Laminate edge trim for worksurface (if laminate option specified).
- 6) Trim color for painted pull (if specified).
- 7) Trim color for lock (required).

Note: Wood grained laminate worksurface finishes are applied with wood grain direction side-to-side only.

*Additional upcharge based on size. Use design and specification tools for pricing.

**Price per pull.

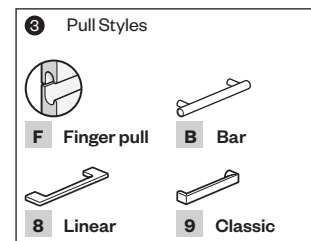

Double Pedestal Desk

Full Overlay Modesty

Height	Depth	Width	Number ① ② ③	HPL		Wood	
				A	B	A	B
HPL							
29.125"(740mm)	30"(762mm)	66"(1676mm)	XLDF-3066-JSS █ █ LF	\$3490.77	\$3539.56		
		72"(1829mm)	XLDF-3072-JSS █ █ LF	3555.07	3609.01		
		78"(1981mm)	XLDF-3078-JSS █ █ LF	3619.37	3678.46		
36"(914mm)	66"(1676mm)	XLDF-3666-JSS █ █ LF	\$3632.23	\$3692.35			
		72"(1829mm)	XLDF-3672-JSS █ █ LF	3709.39	3775.69		
		78"(1981mm)	XLDF-3678-JSS █ █ LF	3786.55	3859.03		
Wood							
29.125"(740mm)	30"(762mm)	66"(1676mm)	XZDF-3066- █ SS █ WF			\$5646.42	\$6283.50
		72"(1829mm)	XZDF-3072- █ SS █ WF			5734.67	6380.70
		78"(1981mm)	XZDF-3078- █ SS █ WF			5822.92	6477.90
36"(914mm)	66"(1676mm)	XZDF-3666- █ SS █ WF			\$5840.57	\$6497.34	
		72"(1829mm)	XZDF-3672- █ SS █ WF			5946.47	6613.98
		78"(1981mm)	XZDF-3678- █ SS █ WF			6052.37	6730.62

Desk Shell

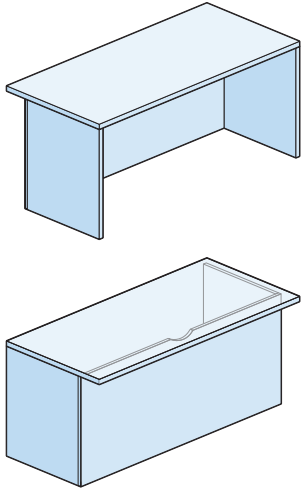

XLYH-SF
XZYH-SF
Class RA

Features

- Includes worksurface, case and attachment hardware.
- 1.18" (30mm) thick high-pressure laminate (HPL) worksurface with 3mm edgeband applied to user and visitor edges only. Ends capped with 1mm thick edgeband. All other components finished in laminate with 1mm thick edgeband.
- 1.18" (30mm) thick Wood worksurface with a choice of profiled edge (Square or Bevel) applied to user and visitor edges. Double-cut veneers available with Square 3mm Radius edge only.
- Full-overlay modesty panel recessed 6" (152mm) for visitor side overhang.
- Unfinished clearcoat wireway scallop in top center of modesty panel.
- Glides provide 2" (51mm) adjustment range.
- Shipped unassembled.

Specification Tips

- Accommodates separately specified box/box/file mobile pedestal without cushion.
- Not for use with a Vertical Storage Unit.
- Accommodates separately specified center drawer.
- See Stack-on Application Rules for upper storage requirements.
- May be used as a freestanding/standalone desk or with separately specified attached modular components to design an L- or U-shaped application. See the Specification Guide for application guidelines.
- Separately specified grommets can be field installed in desk worksurface.

To Order, Specify:

1) Product number, including:

1 Edge Option:

Wood:

1 Square

5 Bevel (add \$247.99 list)

2) Finish code for lower components (laminate or wood).

3) Laminate edge trim for lower components (if laminate option specified).

4) Laminate worksurface color (if laminate option specified).

5) Laminate edge trim for worksurface (if laminate option specified).

Note: Wood grained laminate worksurface finishes are applied with wood grain direction side-to-side only.

*Additional upcharge based on size. Use design and specification tools for pricing.

Height	Depth	Width	Number ①	HPL		Wood	
				A	B	A	B
HPL							
29.125"(740mm)	30"(762mm)	60"(1524mm)	XLYH-3060-JSNF	\$ 2271.02	\$2468.53		
		66"(1676mm)	XLYH-3066-JSNF	2352.77	2556.78		
		72"(1829mm)	XLYH-3072-JSNF	2434.52	2645.03		
	36"(914mm)	66"(1676mm)	XLYH-3666-JSNF	\$2532.62	\$2750.93		
		72"(1829mm)	XLYH-3672-JSNF	2630.72	2856.83		
Wood							
29.125"(740mm)	30"(762mm)	60"(1524mm)	XZYH-3060-SSF			\$3468.02	\$ 3867.01
		66"(1676mm)	XZYH-3066-SSF			3622.32	4036.76
		72"(1829mm)	XZYH-3072-SSF			3776.62	4206.51
	36"(914mm)	66"(1676mm)	XZYH-3666-SSF			\$ 3961.78	\$ 4410.21
		72"(1829mm)	XZYH-3672-SSF			4146.94	4613.91

Table Desk

Hoop Leg

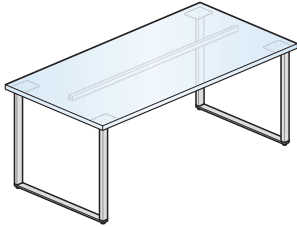

XLAR-3072
XZAR-3072
Class RA

Features

- Includes 1.18" (30mm) thick top, two hoop legs and attachment hardware.
- Reinforcement Bar added to 72" (1829mm), 78" (1981mm) and 84" (2134mm) worktops with hoop leg.
- High-Pressure Laminate (HPL) worksurface with 3mm edgeband applied to user and visitor edges only. Ends capped with 1mm thick edgeband.
- Wood worksurface with a choice of profiled edge (Square or Bevel) applied to user and visitor edges. Double-cut wood worksurface available with Square 3mm Radius edge only.
- Glides have .5" (13mm) height adjustment and are standard in black.
- Depth and width shown in nominal dimensions.
- Ships unassembled.

Specification Tips

- For use as a freestanding/standalone desk; not for use with attached modular components.
- May be used with separately specified Adaptable Modesty Panel.
- May be used with separately specified Belong Screen.

Electrical:

- For use with separately specified electrical components:
(Note: All of the options shown below require field cut mounting holes in the top. Ensure placement provides adequate clearance for table understructure. Ensure placement provides adequate clearance for table understructure.)
 - Flush Mounted Power Module Cord for Height Adjustable or Hardwire
 - Enhanced Power Module Corded or Hardwire with mounting bracket
 - Flip Top Unit Corded or Hardwire
 - Bezel Utility Module
- To limit cords connected to the building power use Power Modules with IEC connector.

To Order, Specify:

1) Product number, including:

1 Surface Option:

- L** Laminate
- Z** Wood

2 Edge Option:

- J** Edgeband (Laminate only)
- 1** Square (Wood only)
- 5** Bevel (Wood only)

2) Laminate surface color or wood finish color.

3) Edge trim color (laminate only).

4) Base trim color.

Note: \$59.41 upcharge (list) for Metallic and accent trim colors.

Depth	Width	Number		HPL		Wood A	Wood B	
		1	2	A	B	1	1	5
30" (762mm)	60" (1524mm)	X	AR-3060- SNHB	\$2048.82	\$ 2199.19	\$3028.10	\$3080.85	\$ 3227.71
	66" (1676mm)	X	AR-3066- SNHB	2098.27	2248.64	3102.90	3157.10	3303.96
	72" (1829mm)	X	AR-3072- SNHB	2147.72	2298.09	3177.70	3233.35	3380.21
36" (914mm)	60" (1524mm)	X	AR-3660- SNHB	\$ 2147.72	\$ 2298.09	\$ 3177.70	\$ 3233.35	\$ 3380.21
	66" (1676mm)	X	AR-3666- SNHB	2207.06	2357.43	3267.46	3324.85	3471.71
	72" (1829mm)	X	AR-3672- SNHB	2266.40	2416.77	3357.22	3416.35	3563.21
	78" (1981mm)	X	AR-3678- SNHB	2325.74	2476.11	3446.98	3507.85	3654.71
	84" (2134mm)	X	AR-3684- SNHB	2385.08	2535.45	3536.74	3599.35	3746.21
42" (1067mm)	72" (1829mm)	X	AR-4272- SNHB	\$ 2385.08	\$ 2535.45	\$ 3536.74	\$ 3599.35	\$ 3746.21
	78" (1981mm)	X	AR-4278- SNHB	2454.31	2604.68	3641.46	3706.10	3852.96
	84" (2134mm)	X	AR-4284- SNHB	2523.54	2673.91	3746.18	3812.85	3959.71

Height Adjustable Table Desk

T-Leg Base

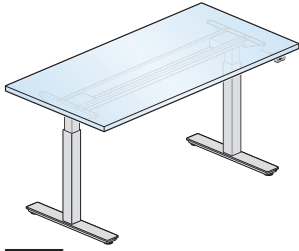

XLAR-3060
XZAR-3060
Class RA

Features

- Includes 1.18"(30mm) thick top, two T-leg base assemblies, wire management clips, height adjustment mechanism and hardware.
- High-Pressure Laminate (HPL) worksurface with 3mm edgeband applied to user and visitor edges only. Ends capped with 1mm thick edgeband.
- Wood worksurface with a choice of profiled edge (Square or Bevel) applied to user and visitor edges. Double-cut wood worksurface available with Square 3mm Radius edge only.
- Top available with standard core.
- Height adjustment touch pad actuator options:
 - Single Stage Touch Pad Actuator available in Standard (E) up/down movement or Programmable (R) providing four different up/down programmed heights. Provides 27"(686mm) to 46"(1168mm) continuous height adjustment range.
- Touch Pad Actuator:
 - Can be mounted on left or right side of table; predrilled for field installed and field changeable.
 - Touch pad actuator has touch pad controls and standard with black housing.
 - Control box is field installed and standard with black housing.
- Height adjustment: 1"(25mm) per 1.6 seconds.
- Telescoping base tubes and J-rails. Telescoping base tubes will match base trim color. Smooth paint trim will match. Textured paint will be complimentary.
- Includes: 9.5'(2895.6mm) long black power cord with NEMA 5-15P plug to the building.
- Base includes leg assembly and foot; available in painted trim colors.
- Glides have .5"(13mm) height adjustment and are standard in black.
- Grommets are available for field installation; separately specified.
- Ships unassembled.

Specification Tips

- Tops are designed to allow pinch point clearance to accommodate cables. The undersized top provides:
 - 1"(25mm) gap along each side of the top between the adjacent furnishings or building architecture.
 - 1"(25mm) gap along the back of the top between the adjacent furnishings or building architecture
- A shroud is an aesthetic cover used to conceal a Height Adjustable T-Leg. Separately specified Reinforcement Channel or Bar are not required.
- For a Height Adjustable Table Desk Shroud application:**
 - Separately specify Shroud for use with Adjustable T-Legs; a pair of shrouds are recommended.
 - An optional, separately specified Modesty Panel for Shroud may be used.
- A Height Adjustable Table Desk without shrouds may be used with a separately specified Adaptable Modesty Panel.

Electrical:

- For use with separately specified electrical components:
 - (Note: All of the options shown below require field cut mounting holes in the top. Ensure placement provides adequate clearance for table understructure.)
 - Flush Mounted Power Module Cord for Height Adjustable or Hardwire
 - Enhanced Power Module Corded or Hardwire with mounting bracket
 - Flip Top Unit Corded or Hardwire
 - Bezel Utility Module
- To limit cords connected to the building power use Power Modules with IEC connector.
- Height Adjustable Tables Desk is not for use with AKP's, suspended or attached pedestals.
- Total lifting capacity of table is 250 lbs. including surface; applied weight should be evenly distributed.

To Order, Specify:

1) Product number, including:

1 Surface Option:

- L** Laminate
- Z** Wood

2 Edge Option:

- J** Edgeband (Laminate only)
- 1** Square (Wood only)
- 5** Bevel (Wood only)

3 Height Adjustment Actuator Option:

Single Stage:

- E** Standard
- R** Programmable (add **\$196.78** list)

2) Laminate surface color or wood finish color.

3) Edge trim color (laminate only).

4) Base trim color.

Note \$59.41 upcharge (list) for Metallic and accent trim colors.

Table Depth and Base	Screens	Monitor Arms
29"(737mm) T-Leg Glides	Yes	Yes (50 lbs max)
35"(889mm) T-Leg Glides	Yes	Yes (50 lbs max)
41"(1041mm) T-Leg Glides	Yes	Yes (50 lbs max)

Height Adjustable Table Desk

T-Leg Base

Depth	Width	Number			HPL		Wood A	Wood B	
		①	②	③	A	B	Edge 1	Edge 1	Edge 5
29"(737mm)	58"(1473mm)	X	AR-3060-	SNTB	\$2803.31	\$2964.20	\$ 3997.06	\$4073.69	\$ 4219.09
	64"(1626mm)	X	AR-3066-	SNTB	2852.76	3013.65	4071.66	4149.64	4295.04
	70"(1778mm)	X	AR-3072-	SNTB	2902.21	3063.10	4146.26	4225.59	4370.99
35"(889mm)	58"(1473mm)	X	AR-3660-	SNTB	\$2902.21	\$3063.10	\$ 4146.26	\$ 4225.59	\$ 4370.99
	64"(1626mm)	X	AR-3666-	SNTB	2961.55	3122.44	4235.78	4316.73	4462.13
	70"(1778mm)	X	AR-3672-	SNTB	3020.89	3181.78	4325.30	4407.87	4553.27
	76"(1930mm)	X	AR-3678-	SNTB	3080.23	3241.12	4414.82	4499.01	4644.41
41"(1041mm)	82"(2083mm)	X	AR-3684-	SNTB	3139.57	3300.46	4504.34	4590.15	4735.55
	70"(1778mm)	X	AR-4272-	SNTB	\$ 3139.57	\$3300.46	\$4504.34	\$4590.15	\$ 4735.55
	76"(1930mm)	X	AR-4278-	SNTB	3208.80	3369.69	4608.78	4696.48	4841.88
	82"(2083mm)	X	AR-4284-	SNTB	3278.03	3438.92	4713.22	4802.81	4948.21

Height Adjustable Convergent Worktop

Rectangular – T-Leg

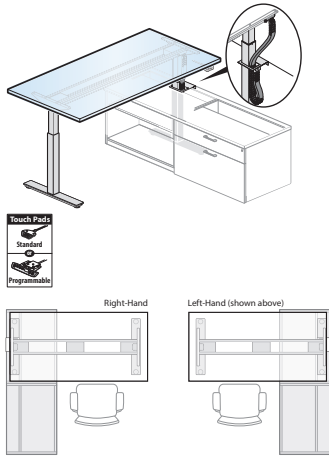

XLNR-3060
XZNR-3060
Class RA

Features

- Includes 1.18" (30mm) convergent worktop, wire management clips, black cable chain, power cord, bezel, attachment hardware, height adjustment mechanism, two T-leg base and adjustable glides.
- High-Pressure Laminate (HPL) worktop with 3mm edgeband applied to user and visitor edges only. Ends capped with 1mm thick edgeband.
- Wood worktop with a choice of profiled edge (Square or Bevel) applied to user and visitor edges. Double-cut wood worktop available with Square 3mm Radius edge only.
- Glides provide .5" (13mm) vertical adjustment.
- Bezel is a metal plate which goes around the column to hide the cutout in top of the storage.
- Height adjustment touch pad actuator options:
 - Single Stage Touch Pad Actuator available in Standard (E) up/down movement or Programmable (R) providing four different up/down heights. Provides 27" (686mm) to 46" (1168mm) continuous height adjustment range.
- Programmable Touch Pad Actuator:
 - Can be mounted on left or right side of table; predrilled for field installed and field changeable.
 - Touch pad actuator has touch pad controls and standard with black housing.
 - Control box is field installed and standard with black housing.
- Height adjustment: 1" (25mm) per 1.6 seconds.
- Telescoping base tubes and J-rails. Telescoping base tubes will match base trim color. Smooth paint trim will match. Textured paint will be complimentary.
- Includes: 9.5' (2743mm) long black power cord with NEMA 5-15P plug to the building.
- Base includes leg assembly and foot; available in painted trim colors.
- Glides have .5" (13mm) height adjustment and are standard in black.
- Grommets are available for field installation; separately specified.
- Ships unassembled.

Specification Tips

- Designed to be used with one of the following separately specified 1.5H lower storage units:
 - 1.5H Attached Sliding Door Storage Unit for use with Convergent Worktop; available 23" (584mm) D, only.
 - 1.5H Attached Storage for use with Convergent Worktop - Open Unit; 18" (457mm) D or 23" (584mm) D.
- Separately specified Reinforcement Channel or Bar are not required.
- Not for use with 1.5H Attached Sliding Door Unit.
- One of the two Height Adjustable T-Legs is concealed within the full height raceway in the back of the 1.5H lower storage unit and the other is exposed.
- A separately specified Shroud for use with Height Adjustable T-Leg may be used as an aesthetic cover for the exposed Height Adjustable T-Leg.
- Trim Finish Recommendation: The bezel on the shroud and the convergent leg to be specified the same color.
- The bezel mounts to the credenza top on the 1.5H lower storage. Installation hole for bezel to be field cut.
- Convergent worktop (with or without a shroud) may be used with a separately specified Adaptable Modesty Panel.

Electrical:

- For use with separately specified electrical components:
 - (Note: All of the options shown below require field cut mounting holes in the top. Ensure placement provides adequate clearance for table understructure.)
 - Flush Mounted Power Module Cord for Height Adjustable or Hardwire
 - Enhanced Power Module Corded or Hardwire with mounting bracket
 - Flip Top Unit Corded or Hardwire
 - Bezel Utility Module
- To limit cords connected to the building power use Power Modules with IEC connector.
- **Height Adjustable Convergent Worktop is not for use with AKP's, suspended or attached pedestals.**
- Worktop load capacity: 100 pounds
- Worktop load capacity (including top) and weight should be evenly distributed.
- Screen and Monitor Arm application:
 - 29" (737mm), 35" (889mm) and 41" (1041mm) D table supports a 27" (686mm) H Belong screen and a monitor up to 50 lbs.

To Order, Specify:

1) Product number, including:

1 Surface Option:

- L** Laminate
- Z** Wood

2 Edge Option:

- J** Edgeband (Laminate only)
- 1** Square (Wood only)
- 5** Bevel (Wood only)

3 Height Adjustment Actuator Option:

Single Stage:

- E** Standard
- R** Programmable (add **\$196.78** list)

2) Laminate surface color or wood finish color.

3) Edge trim color (laminate only).

4) Base trim color.

Note \$59.41 upcharge (list) for Metallic and accent trim colors.

Height Adjustable Convergent Worktop

Rectangular – T-Leg

Depth	Width	Number			HPL		Wood A	Wood B	
		①	②	③	A	B	Edge 1	Edge 1	5
29"(737mm)	58"(1473mm)	X	NR-3060-	SNTB	\$3097.08	\$3247.45	\$4519.92	\$4599.21	\$4746.07
	64"(1626mm)	X	NR-3066-	SNTB	3146.53	3296.90	4594.72	4675.46	4822.32
	70"(1778mm)	X	NR-3072-	SNTB	3195.98	3346.35	4669.52	4751.71	4898.57
35"(889mm)	58"(1473mm)	X	NR-3660-	SNTB	\$3195.98	\$3346.35	\$4669.52	\$4751.71	\$4898.57
	64"(1626mm)	X	NR-3666-	SNTB	3255.32	3405.69	4759.28	4843.21	4990.07
	70"(1778mm)	X	NR-3672-	SNTB	3314.66	3465.03	4849.04	4934.71	5081.57
	76"(1930mm)	X	NR-3678-	SNTB	3374.00	3524.37	4938.80	5026.21	5173.07
41"(1041mm)	82"(2083mm)	X	NR-3684-	SNTB	3433.34	3583.71	5028.56	5117.71	5264.57
	70"(1778mm)	X	NR-4272-	SNTB	\$3433.34	\$3583.71	\$5028.56	\$5117.71	\$5264.57
	76"(1930mm)	X	NR-4278-	SNTB	3502.57	3652.94	5133.28	5224.46	5371.32
	82"(2083mm)	X	NR-4284-	SNTB	3571.80	3722.17	5238.00	5331.21	5478.07

Height Adjustable Convergent Worktop

Wedge Square – T-Leg

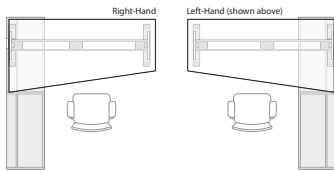
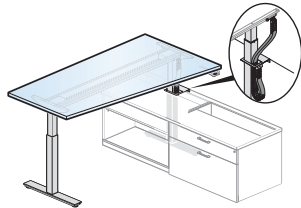

XLNW-4260
XZNW-4260
Class RA

Features

- Includes 1.18" (30mm) convergent worktop, wire management clips, black cable chain, power cord, bezel, attachment hardware, height adjustment mechanism, two T-leg base and adjustable glides.
- High-Pressure Laminate (HPL) worktop with 3mm edgeband applied to user and visitor edges only. Ends capped with 1mm thick edgeband.
- Wood worktop with a choice of profiled edge (Square or Bevel) applied to user and visitor edges. Double-cut wood worktop available with Square 3mm Radius edge only.
- Glides provide .5" (13mm) vertical adjustment.
- Bezel is a metal plate which goes around the column to hide the cutout in top of the storage.
- The cable chain is located on the back of the leg for right-hand convergent; front of the leg on left-hand convergent.
- Height adjustment touch pad actuator options:
 - Single Stage Touch Pad Actuator available in Standard (E) up/down movement or Programmable (R) providing four different up/down heights. Provides 27" (686mm) to 46" (1168mm) continuous height adjustment range.
 - Programmable Touch Pad Actuator:
 - Can be mounted on left or right side of table; predrilled for field installed and field changeable.
 - Touch pad actuator has touch pad controls and standard with black housing.
 - Control box is field installed and standard with black housing.
- Height adjustment: 1" (25mm) per 1.6 seconds.
- Telescoping base tubes and J-rails. Telescoping base tubes will match base trim color. Smooth paint trim will match. Textured paint will be complimentary.
- Includes: 9.5' (2743mm) long black power cord with NEMA 5-15P plug to the building.
- Base includes leg assembly and foot; available in painted trim colors.
- Glides have .5" (13mm) height adjustment and are standard in black.
- Grommets are available for field installation; separately specified.
- Ships unassembled.

Specification Tips

- Designed to be used with one of the following separately specified 1.5H lower storage units:
 - 1.5H Attached Sliding Door Storage Unit for use with Convergent Worktop; available 23" (584mm)D, only.
 - 1.5H Attached Storage for use with Convergent Worktop - Open Unit; 18" (457mm)D or 23" (584mm)D.
- Separately specified Reinforcement Channel or Bar are not required.
- Not for use with 1.5H Attached Sliding Door Unit.
- One of the two Height Adjustable T-Legs is concealed within the full height raceway in the back of the 1.5H lower storage unit and the other is exposed.
- A separately specified Shroud for use with Height Adjustable T-Leg may be used as an aesthetic cover for the exposed Height Adjustable T-Leg.
- Trim Finish Recommendation: The bezel on the shroud and the convergent leg to be specified the same color.
- The bezel mounts to the credenza top on the 1.5H lower storage. Installation hole for bezel to be field cut.
- Convergent worktop (with or without a shroud) may be used with a separately specified Adaptable Modesty Panel.

Electrical:

- For use with separately specified electrical components:
 - (Note: All of the options shown below require field cut mounting holes in the top. Ensure placement provides adequate clearance for table understructure.)
 - Flush Mounted Power Module Cord for Height Adjustable or Hardwire
 - Enhanced Power Module Corded or Hardwire with mounting bracket
 - Flip Top Unit Corded or Hardwire
 - Bezel Utility Module
- To limit cords connected to the building power use Power Modules with IEC connector.
- **Height Adjustable Convergent Worktop is not for use with AKP's, suspended or attached pedestals.**
- Worktop load capacity: 100 pounds
- Worktop load capacity (including top) and weight should be evenly distributed.
- Screen and Monitor Arm application:
 - 29" (737mm), 35" (889mm) and 41" (1041mm)D table supports a 27" (686mm)H Belong screen and a monitor up to 50 lbs.

To Order, Specify:

1) Product number, including:

1 Surface Option:

- L** Laminate
- Z** Wood

2 Edge Option:

- J** Edgeband (Laminate only)
- 1** Square (Wood only)
- 5** Bevel (Wood only)

3 Orientation Option:

- R** Right-hand
- L** Left-hand

4 Height Adjustment Actuator Option:

Single Stage:

- E** Standard
- R** Programmable (add **\$196.78** list)

2) Laminate surface color or wood finish color.

3) Edge trim color (laminate only).

4) Base trim color.

Note: \$59.41 upcharge (list) for Metallic and accent trim colors.

Height Adjustable Convergent Worktop

Wedge Square – T-Leg

Depth	Width	Number				HPL		Wood A	Wood B	
		①	②	③	④	A	B	Edge 1	Edge 1	5
41"(1041mm)	58"(1473mm)	X	NW-4260-	S	TB	\$ 3474.80	\$ 3625.17	\$5089.75	\$ 5180.27	\$ 5327.13
	64"(1626mm)	X	NW-4266-	S	TB	3544.03	3694.40	5194.47	5287.02	5433.88
	70"(1778mm)	X	NW-4272-	S	TB	3613.26	3763.63	5299.19	5393.77	5540.63
	76"(1930mm)	X	NW-4278-	S	TB	3682.49	3832.86	5403.91	5500.52	5647.38
	82"(2083mm)	X	NW-4284-	S	TB	3751.72	3902.09	5508.63	5607.27	5754.13
47"(1194mm)	58"(1473mm)	X	NW-4860-	S	TB	\$ 3573.70	\$ 3724.07	\$ 5239.35	\$ 5332.77	\$ 5479.63
	64"(1626mm)	X	NW-4866-	S	TB	3652.82	3803.19	5359.03	5454.77	5601.63
	70"(1778mm)	X	NW-4872-	S	TB	3731.94	3882.31	5478.71	5576.77	5723.63
	76"(1930mm)	X	NW-4878-	S	TB	3811.06	3961.43	5598.39	5698.77	5845.63
	82"(2083mm)	X	NW-4884-	S	TB	3890.18	4040.55	5718.07	5820.77	5967.63

Height Adjustable Convergent Worktop

Wedge Radius – T-Leg

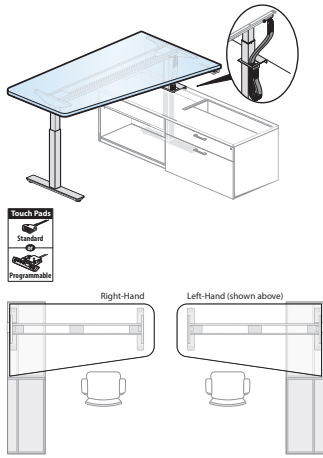

XLNG-4260
XZNG-4260
Class RA

Features

- Includes 1.18" (30mm) convergent worktop, wire management clips, black cable chain, power cord, bezel, attachment hardware, height adjustment mechanism, two T-leg base and adjustable glides.
- High-Pressure Laminate (HPL) worktop with 3mm edgeband applied to user and visitor edges only. Ends capped with 1mm thick edgeband.
- Wood worktop with profile square edge applied to user and visitor edges.
- Glides provide .5" (13mm) vertical adjustment.
- Bezel is a metal plate which goes around the column to hide the cutout in top of the storage.
- The cable chain is located on the back of the leg for right-handed convergent; front of the leg on left-hand convergent. Cable chain accommodates 2 power and 1 data cords.
- Height adjustment touch pad actuator options:
 - Single Stage Touch Pad Actuator available in Standard (E) up/down movement or Programmable (R) providing four different up/down programmed heights. Provides 27" (686mm) to 46" (1168mm) continuous height adjustment range.
- Programmable Touch Pad Actuator:
 - Can be mounted on left or right side of table; predrilled for field installed and field changeable.
 - Touch pad actuator has touch pad controls and standard with black housing.
 - Control box is field installed and standard with black housing.
- Height adjustment: 1" (25mm) per 1.6 seconds.
- Telescoping base tubes and J-rails. Telescoping base tubes will match base trim color. Smooth paint trim will match. Textured paint will be complimentary.
- Includes: 9.5' (2895.6mm) long black power cord with NEMA 5-15P plug to the building.
- Base includes leg assembly and foot; available in painted trim colors.
- Glides have .5" (13mm) height adjustment and are standard in black.
- Grommets are available for field installation; separately specified.
- Ships unassembled.

Specification Tips

- Designed to be used with one of the following separately specified 1.5H lower storage units:
 - 1.5H Attached Sliding Door Storage Unit for use with Convergent Worktop; available 23" (584mm)D, only.
 - 1.5H Attached Storage for use with Convergent Worktop - Open Unit; 18" (457mm)D or 23" (584mm)D.
- Separately specified Reinforcement Channel or Bar are not required.
- Not for use with 1.5H Attached Sliding Door Unit.
- One of the two Height Adjustable T-Legs is concealed within the full height raceway in the back of the 1.5H lower storage unit and the other is exposed.
- A separately specified Shroud for use with Height Adjustable T-Leg may be used as an aesthetic cover for the exposed Height Adjustable T-Leg.
- Trim Finish Recommendation: The bezel on the shroud and the convergent leg to be specified the same color.
- The bezel mounts to the credenza top on the 1.5H lower storage. Installation hole for bezel to be field cut.
- Convergent worktop (with or without a shroud) may be used with a separately specified Adaptable Modesty Panel.

Electrical:

- For use with separately specified electrical components:
 - (Note: All of the options shown below require field cut mounting holes in the top. Ensure placement provides adequate clearance for table understructure.)
 - Flush Mounted Power Module Cord for Height Adjustable or Hardwire
 - Enhanced Power Module Corded or Hardwire with mounting bracket
 - Flip Top Unit Corded or Hardwire
 - Bezel Utility Module
- To limit cords connected to the building power use Power Modules with IEC connector.
- **Height Adjustable Convergent Worktop is not for use with AKP's, suspended or attached pedestals.**
- Worktop load capacity: 100 pounds
- Worktop load capacity (including top) and weight should be evenly distributed.
- Screen and Monitor Arm application:
 - 29" (737mm), 35" (889mm) and 41" (1041mm)D table supports a 27" (686mm)H Belong screen and a monitor up to 50 lbs.

To Order, Specify:

- 1) Product number, including:

1 Surface Option:

- L** Laminate
- Z** Wood

2 Edge Option:

- J** Edgeband (Laminate only)
- 1** Square (Wood only)

3 Orientation Option:

- R** Right-hand
- L** Left-hand

4 Height Adjustment Actuator Option:

Single Stage:

- E** Standard
- R** Programmable
(add **\$196.78** list)

- 2) Laminate surface color or wood finish color.
- 3) Edge trim color (laminate only).
- 4) Base trim color.

Note: \$59.41 upcharge (list) for Metallic and accent trim colors.

Height Adjustable Convergent Worktop

Wedge Radius – T-Leg

Depth	Width	Number				HPL		Wood A Edge	Wood B Edge
		①	②	③	④	A	B	1	1
41"(1041mm)	58"(1473mm)	X	NG-4260-	S	TB	\$3633.87	\$3784.24	\$5250.17	\$5340.78
	64"(1626mm)	X	NG-4266-	S	TB	3703.10	3853.47	5354.89	5447.53
	70"(1778mm)	X	NG-4272-	S	TB	3772.33	3922.70	5459.61	5554.28
	76"(1930mm)	X	NG-4278-	S	TB	3841.56	3991.93	5564.33	5661.03
	82"(2083mm)	X	NG-4284-	S	TB	3910.79	4061.16	5669.05	5767.78
47"(1194mm)	58"(1473mm)	X	NG-4860-	S	TB	\$3732.77	\$3883.14	\$5399.77	\$5493.28
	64"(1626mm)	X	NG-4866-	S	TB	3811.89	3962.26	5519.45	5615.28
	70"(1778mm)	X	NG-4872-	S	TB	3891.01	4041.38	5639.13	5737.28
	76"(1930mm)	X	NG-4878-	S	TB	3970.13	4120.50	5758.81	5859.28
	82"(2083mm)	X	NG-4884-	S	TB	4049.25	4199.62	5878.49	5981.28

Convergent Worktop for use with 1.5H Storage

Rectangular with Column or Hoop

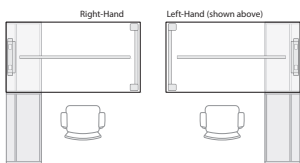
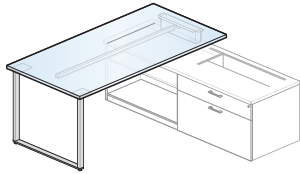
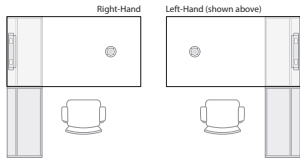
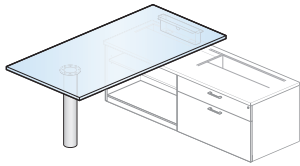

XLNR-3072
XZNR-3072
Class RA

Features

- Includes 1.18" (30mm) thick worktop, one column or hoop, stanchion and attachment hardware.
- Reinforcement Bar added to 72" (1829mm), 78" (1981mm) and 84" (2134mm) worktop with hoop leg.
- High-Pressure Laminate (HPL) worktop with 3mm edgeband applied to user and visitor edges. Ends capped with 1mm thick edgeband.
- Wood worktop with a choice of profiled edge (Square or Bevel) applied to user and visitor edges.
- Double-cut veneers available with Square 3mm Radius edge only.
- Glides have .5" (13mm) height adjustment and are standard in black.
- Grommets are available for field installation; separately specified.
- Depth and width shown in nominal dimensions.
- Ships unassembled.

Specification Tips

- Must be attached to a 1.5H lower storage unit; 18" (457mm) or 23" (584mm) D.
- The stanchion is typically positioned above the back raceway of the 1.5H lower storage.
- The stanchion mounts to a separately specified credenza top.
- Stanchion screws to credenza top; field installed. See Specification Guide for location details.
- May be used with separately specified Adaptable Modesty Panel.

Electrical:

- For use with separately specified electrical components:
(Note: All of the options shown below require field cut mounting holes in the top. Ensure placement provides adequate clearance for table understructure.)
 - Flush Mounted Power Module with Plug or Hardwire
 - Enhanced Power Module Corded or Hardwire
 - Flip Top Unit Corded or Hardwire
 - Bezel Utility Module

To Order, Specify:

- 1) Product number, including:
 - 1 Surface Option:**
 - L** Laminate
 - Z** Wood
 - 2 Edge Option:**
 - J** Edgeband (Laminate only)
 - 1** Square (Wood only)
 - 5** Bevel (Wood only)
- 2) Laminate surface color or wood finish color.
- 3) Edge trim color (laminate only).
- 4) Base trim color.

Note: \$59.41 upcharge (list) for Metallic and accent trim colors.

Depth	Width	Number		HPL		Wood A	Wood B	
		1	2	A	B	1	1	5
Column								
30" (762mm)	60" (1524mm)	X	NR-3060- SNCB	\$ 1723.49	\$ 1873.86	\$ 2737.00	\$ 2791.75	\$ 2938.61
	66" (1676mm)	X	NR-3066- SNCB	1772.94	1923.31	2811.80	2868.00	3014.86
	72" (1829mm)	X	NR-3072- SNCB	1822.39	1972.76	2886.60	2944.25	3091.11
36" (914mm)	60" (1524mm)	X	NR-3660- SNCB	\$ 1822.39	\$ 1972.76	\$ 2886.60	\$ 2944.25	\$ 3091.11
	66" (1676mm)	X	NR-3666- SNCB	1881.73	2032.10	2976.36	3035.75	3182.61
	72" (1829mm)	X	NR-3672- SNCB	1941.07	2091.44	3066.12	3127.25	3274.11
	78" (1981mm)	X	NR-3678- SNOB	2000.41	2150.78	3155.88	3218.75	3365.61
	84" (2134mm)	X	NR-3684- SNCB	2059.75	2210.12	3245.64	3310.25	3457.11
42" (1067mm)	72" (1829mm)	X	NR-4272- SNCB	\$ 2059.75	\$ 2210.12	\$ 3245.64	\$ 3310.25	\$ 3457.11
	78" (1981mm)	X	NR-4278- SNOB	2128.98	2279.35	3350.36	3417.00	3563.86
	84" (2134mm)	X	NR-4284- SNCB	2198.21	2348.58	3455.08	3523.75	3670.61
Hoop								
30" (762mm)	60" (1524mm)	X	NR-3060- SNHB	\$ 1723.49	\$ 1873.86	\$ 2737.00	\$ 2791.75	\$ 2938.61
	66" (1676mm)	X	NR-3066- SNHB	1772.94	1923.31	2811.80	2868.00	3014.86
	72" (1829mm)	X	NR-3072- SNHB	1822.39	1972.76	2886.60	2944.25	3091.11
36" (914mm)	60" (1524mm)	X	NR-3660- SNHB	\$ 1822.39	\$ 1972.76	\$ 2886.60	\$ 2944.25	\$ 3091.11
	66" (1676mm)	X	NR-3666- SNHB	1881.73	2032.10	2976.36	3035.75	3182.61
	72" (1829mm)	X	NR-3672- SNHB	1941.07	2091.44	3066.12	3127.25	3274.11
	78" (1981mm)	X	NR-3678- SNHB	2000.41	2150.78	3155.88	3218.75	3365.61
	84" (2134mm)	X	NR-3684- SNHB	2059.75	2210.12	3245.64	3310.25	3457.11
42" (1067mm)	72" (1829mm)	X	NR-4272- SNHB	\$ 2059.75	\$ 2210.12	\$ 3245.64	\$ 3310.25	\$ 3457.11
	78" (1981mm)	X	NR-4278- SNHB	2128.98	2279.35	3350.36	3417.00	3563.86
	84" (2134mm)	X	NR-4284- SNHB	2198.21	2348.58	3455.08	3523.75	3670.61

Convergent Worktop for use with 1.5H Storage Wedge Square with Column or Hoop

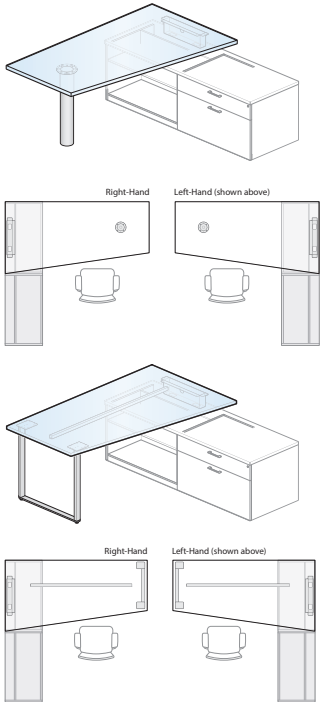

XLNW-4272
XZNW-4272
Class RA

Features

- Includes 1.18"(30mm) thick worktop, one column or hoop, stanchion and attachment hardware.
- Reinforcement Bar added to 72"(1829mm), 78"(1981mm) and 84"(2134mm) worktop with hoop leg.
- High-Pressure Laminate (HPL) worktop with 3mm edgeband applied to user and visitor edges. Ends capped with 1mm thick edgeband.
- Wood worktop with a choice of profiled edge (Square or Bevel) applied to user and visitor edges.
- Double-cut veneers available with Square 3mm Radius edge only.
- Glides have .5"(13mm) height adjustment and are standard in black.
- Grommets are available for field installation; separately specified.
- Depth and width shown in nominal dimensions.
- Ships unassembled.

Specification Tips

- Must be attached to a 1.5H lower storage unit; 18"(457mm) or 23"(584mm)D.
- The stanchion is typically positioned above the back raceway of the 1.5H lower storage.
- The stanchion mounts to a separately specified credenza top.
- Stanchion screws to credenza top; field installed. See Specification Guide for location details.
- May be used with separately specified Adaptable Modesty Panel.

Electrical:

- For use with separately specified electrical components:
(Note: All of the options shown below require field cut mounting holes in the top. Ensure placement provides adequate clearance for table understructure.)
- Flush Mounted Power Module with Plug or Hardwire
- Enhanced Power Module Corded or Hardwire
- Flip Top Unit Corded or Hardwire
- Bezel Utility Module

To Order, Specify:

1) Product number, including:

1 Surface Option:

- L** Laminate
- Z** Wood

2 Edge Option:

- J** Edgeband (Laminate only)
- 1** Square (Wood only)
- 5** Bevel (Wood only)

3 Orientation Option:

- R** Right-hand
- L** Left-hand Column or Hoop Leg Finish

2) Laminate surface color or wood finish color.

3) Edge trim color (laminate only).

4) Base trim color.

Note: \$59.41 upcharge (list) for Metallic and accent trim colors.

Depth	Width	Number			HPL		Wood A	Wood B		
		1	2	3	A	B	1	5		
Column										
42"(1067mm)	60"(1524mm)	X	NW-4260-	S	CB	\$ 1739.74	\$ 1890.11	\$ 3336.95	\$ 3426.44	\$ 3573.30
	66"(1676mm)	X	NW-4266-	S	CB	1808.97	1959.34	3441.67	3533.19	3680.05
	72"(1829mm)	X	NW-4272-	S	CB	1878.20	2028.57	3546.39	3639.94	3786.80
	78"(1981mm)	X	NW-4278-	S	CB	1947.43	2097.80	3651.11	3746.69	3893.55
	84"(2134mm)	X	NW-4284-	S	CB	2016.66	2167.03	3755.83	3853.44	4000.30
48"(1219mm)	60"(1524mm)	X	NW-4860-	S	CB	\$ 1838.64	\$ 1989.01	\$ 3486.55	\$ 3578.94	\$ 3725.80
	66"(1676mm)	X	NW-4866-	S	CB	1917.76	2068.13	3606.23	3700.94	3847.80
	72"(1829mm)	X	NW-4872-	S	CB	1996.88	2147.25	3725.91	3822.94	3969.80
	78"(1981mm)	X	NW-4878-	S	CB	2076.00	2226.37	3845.59	3944.94	4091.80
	84"(2134mm)	X	NW-4884-	S	CB	2155.12	2305.49	3965.27	4066.94	4213.80
Hoop										
42"(1067mm)	60"(1524mm)	X	NW-4260-	S	HB	\$ 1739.74	\$ 1890.11	\$ 3336.95	\$ 3426.44	\$ 3573.30
	66"(1676mm)	X	NW-4266-	S	HB	1808.97	1959.34	3441.67	3533.19	3680.05
	72"(1829mm)	X	NW-4272-	S	HB	1878.20	2028.57	3546.39	3639.94	3786.80
	78"(1981mm)	X	NW-4278-	S	HB	1947.43	2097.80	3651.11	3746.69	3893.55
	84"(2134mm)	X	NW-4284-	S	HB	2016.66	2167.03	3755.83	3853.44	4000.30
48"(1219mm)	60"(1524mm)	X	NW-4860-	S	HB	\$ 1838.64	\$ 1989.01	\$ 3486.55	\$ 3578.94	\$ 3725.80
	66"(1676mm)	X	NW-4866-	S	HB	1917.76	2068.13	3606.23	3700.94	3847.80
	72"(1829mm)	X	NW-4872-	S	HB	1996.88	2147.25	3725.91	3822.94	3969.80
	78"(1981mm)	X	NW-4878-	S	HB	2076.00	2226.37	3845.59	3944.94	4091.80
	84"(2134mm)	X	NW-4884-	S	HB	2155.12	2305.49	3965.27	4066.94	4213.80

Convergent Worktop for use with 1.5H Storage

Wedge Radius with Column or Hoop

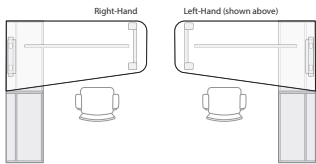
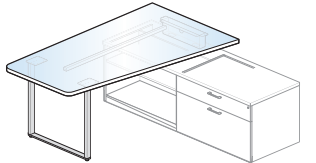
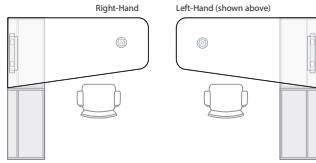
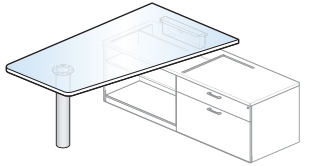

XLNG-4272
XZNG-4272
Class RA

Features

- Includes 1.18"(30mm) thick worktop, one column or hoop, stanchion and attachment hardware.
- Reinforcement Bar added to 72"(1829mm), 78"(1981mm) and 84"(2134mm) worktop with hoop leg.
- High-Pressure Laminate (HPL) worktop with 3mm edgeband applied to user and visitor edges. Ends capped with 1mm thick edgeband.
- Wood worktop with a choice of profiled edge (Square or Bevel) applied to user and visitor edges.
- Double-cut veneers available with Square 3mm Radius edge only.
- Glides have .5"(13mm) height adjustment and are standard in black.
- Grommets are available for field installation; separately specified.
- Depth and width shown in nominal dimensions.
- Ships unassembled.

Specification Tips

- Must be attached to a 1.5H lower storage unit; 18"(457mm) or 23"(584mm)D.
- The stanchion is typically positioned above the back raceway of the 1.5H lower storage.
- The stanchion mounts to a separately specified credenza top.
- Stanchion screws to credenza top; field installed. See Specification Guide for location details.
- May be used with separately specified Adaptable Modesty Panel.

Electrical:

- For use with separately specified electrical components:
(Note: All of the options shown below require field cut mounting holes in the top. Ensure placement provides adequate clearance for table understructure.)
- Flush Mounted Power Module with Plug or Hardwire
- Enhanced Power Module Corded or Hardwire
- Flip Top Unit Corded or Hardwire
- Bezel Utility Module

To Order, Specify:

1) Product number, including:

1 Surface Option:

- L** Laminate
- Z** Wood

2 Edge Option:

- J** Edgeband (Laminate only)
- 1** Square (Wood only)

3 Orientation Option:

- R** Right-hand
- L** Left-hand

2) Laminate surface color or wood finish color.

3) Edge trim color (laminate only).

4) Base trim color.

Note: \$59.41 upcharge (list) for Metallic and accent trim colors.

Depth	Width	Number			HPL		Wood A	Wood B	
		1	2	3	A	B	1	1	
Column									
42"(1067mm)	60"(1524mm)	X	NG-4260-	S	CB	\$ 1898.80	\$2049.17	\$ 3497.36	\$3586.93
	66"(1676mm)	X	NG-4266-	S	CB	1968.03	2118.40	3602.08	3693.68
	72"(1829mm)	X	NG-4272-	S	CB	2037.26	2187.63	3706.80	3800.43
	78"(1981mm)	X	NG-4278-	S	CB	2106.49	2256.86	3811.52	3907.18
	84"(2134mm)	X	NG-4284-	S	CB	2175.72	2326.09	3916.24	4013.93
48"(1219mm)	60"(1524mm)	X	NG-4860-	S	CB	\$ 1997.70	\$ 2148.07	\$3646.96	\$ 3739.43
	66"(1676mm)	X	NG-4866-	S	CB	2076.82	2227.19	3766.64	3861.43
	72"(1829mm)	X	NG-4872-	S	CB	2155.94	2306.31	3886.32	3983.43
	78"(1981mm)	X	NG-4878-	S	CB	2235.06	2385.43	4006.00	4105.43
	84"(2134mm)	X	NG-4884-	S	CB	2314.18	2464.55	4125.68	4227.43
Hoop									
42"(1067mm)	60"(1524mm)	X	NG-4260-	S	HB	\$ 1898.80	\$2049.17	\$ 3497.36	\$3586.93
	66"(1676mm)	X	NG-4266-	S	HB	1968.03	2118.40	3602.08	3693.68
	72"(1829mm)	X	NG-4272-	S	HB	2037.26	2187.63	3706.80	3800.43
	78"(1981mm)	X	NG-4278-	S	HB	2106.49	2256.86	3811.52	3907.18
	84"(2134mm)	X	NG-4284-	S	HB	2175.72	2326.09	3916.24	4013.93
48"(1219mm)	60"(1524mm)	X	NG-4860-	S	HB	\$ 1997.70	\$ 2148.07	\$3646.96	\$ 3739.43
	66"(1676mm)	X	NG-4866-	S	HB	2076.82	2227.19	3766.64	3861.43
	72"(1829mm)	X	NG-4872-	S	HB	2155.94	2306.31	3886.32	3983.43
	78"(1981mm)	X	NG-4878-	S	HB	2235.06	2385.43	4006.00	4105.43
	84"(2134mm)	X	NG-4884-	S	HB	2314.18	2464.55	4125.68	4227.43

Shroud

Use with Height Adjustable T-Leg

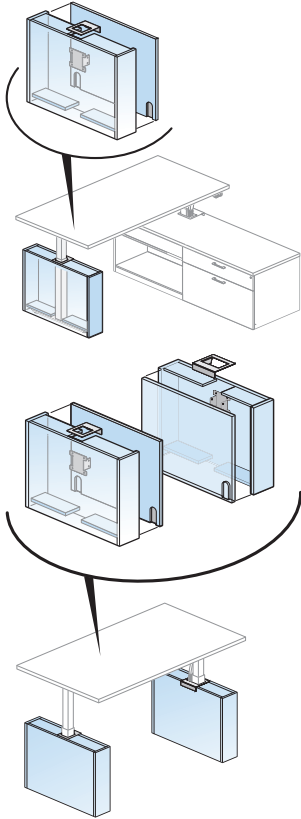

XLSI-3060
XZSI-3060
Class RA

Features

- Include:
 - Single Shroud, bezel and attachment hardware.
 - Pair of Shrouds, bezel, cable chain bracket, cable chain and attachment hardware.
 - Shroud (s) are finished on all sides and top.

Specification Tips

- For use with the following:
 - Height Adjustable Table Desk Rectangular Top - T-Leg Base (pair of shrouds)
 - Height Adjustable Convergent Worktop- T-Leg (single shroud)
 - Rectangular
 - Wedge Square
 - Wedge Radius
- Not for use with the Height Adjustable Credenza Desk-Rectangular -T-Leg Base; dimensionally different shroud.
- A pair of shrouds will accept a separately specified Modesty Panel for Shroud.

To Order, Specify:

1) Product number, including:

1 Surface Option:

- L** Laminate
- Z** Wood

2) Laminate surface color or wood finish color.

3) Edge trim color (laminated only).

4) Bezel trim color (color should match the base color of the table).

Note: \$142.84 upcharge (list) per bezel for Metallic and accent trim colors.

For Use With	Nominal Width	Actual Width	Number	HPL		Wood	
				A	B	A	B
Single							
	30"(762mm)	24"(610mm)	X S1-3000-SE	\$ 1151.52	\$ 1201.51	\$ 1563.72	\$ 1587.87
	36"(914mm)	30"(762mm)	X S1-3600-SE	1196.79	1247.08	1679.17	1707.53
	42"(1067mm)	36"(914mm)	X S1-4200-SE	1242.06	1292.65	1794.62	1827.19
Pair							
	30"(762mm)	24"(610mm)	X S2-3000-SE	\$2303.04	\$2403.02	\$ 3127.44	\$ 3175.74
	36"(914mm)	30"(762mm)	X S2-3600-SE	2393.58	2494.16	3358.34	3415.06
	42"(1067mm)	36"(914mm)	X S2-4200-SE	2484.12	2585.30	3589.24	3654.38

Modesty Panel

Use with Shroud

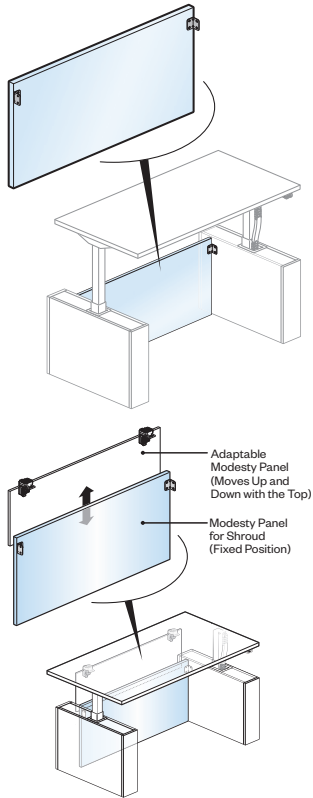

XLXS-2260
XZXS-2260
Class RA

Features

- Includes modesty panel and attachment hardware.
- Modesty Panels are 22.4"(569mm)H (actual) and .75"(19mm) thick.
- Modesty Panels are mounted between the pair of shrouds.
- Panel and hardware are field installed.

Specification Tips

- For use on Height Adjustable Table Desk with a pair of shrouds.
- Specify Modesty Panel for Shroud the same width as the Height Adjustable Table Desk.
- A Height Adjustable Table Desk with a pair of shrouds may be used with either a Modesty Panel for Shroud or an Adaptable Modesty Panel or both modesty panels may be used together in a layered application:
 - The Modesty Panel for Shroud is installed inboard of the Adaptable Modesty panel.
 - The Modesty Panel for Shroud is stationary and provides modesty between the pair of shrouds.
 - The Adaptable Modesty Panel is attached to the underside of the desk and provides height adjustable modesty when the desk is raised or lowered.
 - When the Table Desk is raised to full height a 9"(229mm) gap between panels.

Note: To specify an Adaptable Modesty Panel refer to the **Modesty Panel for use with Shroud Specification Matrix for the appropriate width Adaptable Modesty Panel** - shown on the Adaptable Modesty Panel page.

To Order, Specify:

- 1) Product number.
- 2) Laminate or wood finish.
- 3) Edge trim color (laminate only).

Height	Width	Number	HPL		Wood	
			A	B	A	B
HPL						
22"(559mm)	60"(1524mm)	XLXS-2260	\$414.53	\$ 419.77		
	66"(1676mm)	XLXS-2266	447.23	455.09		
	72"(1829mm)	XLXS-2272	479.93	490.41		
	78"(1981mm)	XLXS-2278	512.63	525.73		
	84"(2134mm)	XLXS-2284	545.33	561.05		
Wood						
22"(559mm)	60"(1524mm)	XZXS-2260			\$ 875.56	\$ 907.20
	66"(1676mm)	XZXS-2266			937.66	973.04
	72"(1829mm)	XZXS-2272			999.76	1038.88
	78"(1981mm)	XZXS-2278			1061.86	1104.72
	84"(2134mm)	XZXS-2284			1123.96	1170.56

Convergent T-Worktop

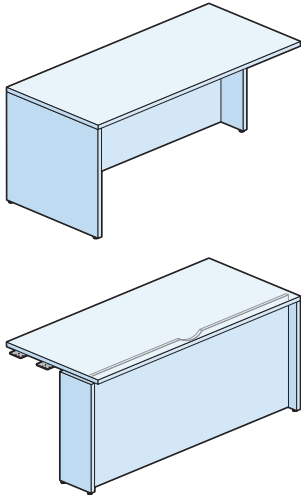

XLTH-FL
XZTH-FL
(Left-hand shown)
Class RA

Features

- Includes 1.18" (30mm) worktop, case, one end panel, one 10.13" (257mm) D light-block panel and attachment hardware.
- High-Pressure Laminate (HPL) worktop with 3mm edgeband applied to user and visitor edges. Ends capped with 1mm thick edgeband. All other components finished in laminate with 1mm thick edgeband.
- Wood worktop with a choice of profiled edge (Square or Bevel) applied to user and visitor edges.
- Double-cut veneers available with Square 3mm Radius edge only.
- Attachment edge of wood veneer worktops with Bevel profiled edges is coped.
- Full modesty panel recessed 6" (152mm) for visitor side overhang.
- Unfinished clearcoat wireway scallop in top center of modesty panel.
- Glides provide 2" (51mm) adjustment range.
- Shipped unassembled.

Specification Tips

- Handed design (left or right) based on position of attachment side.
- Not designed to stand alone.
- Two flat brackets to allow for attachment to modular credenza.
- Does not accommodate separately specified attached 2H storage.
- Accommodates separately specified center drawer.
- Separately specified grommets can be field installed in convergent worktop.

To Order, Specify:

1) Product number, including:

1 Edge Option:

Wood:

- 1 Square
- 5 Bevel (add \$247.99* list)

2 Orientation:

- L Left-hand
- R Right-hand

2) Finish code for lower components (laminate or wood).

3) Laminate edge trim for lower components (if laminate option specified).

4) Laminate worktop color (if laminate option specified).

5) Laminate edge trim for worktop (if laminate option specified).

Note: Wood grained laminate worktop finishes are applied with wood grain direction side-to-side only.

*Additional upcharge based on size. Use design and specification tools for pricing.

Height	Depth	Width	Number ① ②	HPL		Wood			
				A	B	A	B		
HPL									
29.125" (740mm)	30" (762mm)	48" (1219mm)	XLTH-3048-JSNF	\$ 2199.27	\$2396.69				
		54" (1372mm)	XLTH-3054-JSNF	2273.92	2479.59				
		60" (1524mm)	XLTH-3060-JSNF	2348.57	2562.49				
		66" (1676mm)	XLTH-3066-JSNF	2423.22	2645.39				
		72" (1829mm)	XLTH-3072-JSNF	2497.87	2728.29				
		78" (1981mm)	XLTH-3078-JSNF	2572.52	2811.19				
	36" (914mm)	48" (1219mm)	XLTH-3648-JSNF	\$ 2318.71	\$2529.33				
		54" (1372mm)	XLTH-3654-JSNF	2408.29	2628.81				
		60" (1524mm)	XLTH-3660-JSNF	2497.87	2728.29				
		66" (1676mm)	XLTH-3666-JSNF	2587.45	2827.77				
		72" (1829mm)	XLTH-3672-JSNF	2677.03	2927.25				
		78" (1981mm)	XLTH-3678-JSNF	2766.61	3026.73				
		Wood							
		29.125" (740mm)	30" (762mm)	48" (1219mm)	XZTH-3048-SSF			\$3358.24	\$ 3744.58
54" (1372mm)	XZTH-3054-SSF					3478.29	3876.73		
60" (1524mm)	XZTH-3060-SSF					3598.34	4008.88		
66" (1676mm)	XZTH-3066-SSF					3718.39	4141.03		
72" (1829mm)	XZTH-3072-SSF					3838.44	4273.18		
78" (1981mm)	XZTH-3078-SSF					3958.49	4405.33		
36" (914mm)	48" (1219mm)		XZTH-3648-SSF			\$3550.32	\$ 3956.02		
	54" (1372mm)		XZTH-3654-SSF			3694.38	4114.60		
	60" (1524mm)		XZTH-3660-SSF			3838.44	4273.18		
	66" (1676mm)		XZTH-3666-SSF			3982.50	4431.76		
	72" (1829mm)		XZTH-3672-SSF			4126.56	4590.34		
	78" (1981mm)		XZTH-3678-SSF			4270.62	4748.92		

Convergent D-Worktop

T-Support and Column

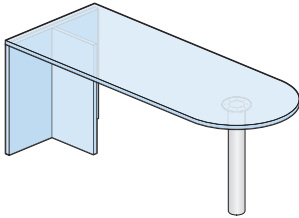

XLYD-SF
XZYB-SF
48"-96" widths

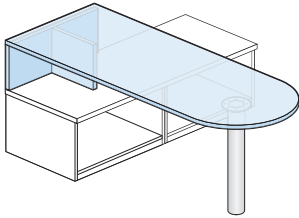

XLYD-SP
XZYD-SP
72"-96" widths
Class RA

Features

- Includes 1.18"(30mm) worktop, T-support end panel, column leg and column leg attachment hardware.
- High-Pressure Laminate (HPL) worktop with 3mm edgeband applied to user and visitor edges only. Ends capped with 1mm thick edgeband. All other components finished in laminate with 1mm thick edgeband.
- Worktop with a choice of profiled edge (Square or Bevel) applied to user and visitor edges.
- Double-cut veneers available with Square 3mm Radius edge only.
- Partial height end panel available on 72"(1829mm)-96"(2438mm)W tops.
- 4"(102mm) diameter column leg with 3"(76mm) adjustment.
- Shipped unassembled.

Specification Tips

- Not designed to stand alone.
- See Stack-on Application Rules in Specification Guide.
- Desk with partial height end panel to be supported on one-high modular bench.
- Accommodates separately specified center drawer.
- Separately specified grommets can be field installed in desk worksurface.
- See 1H Application Rules in Specification Guide.

To Order, Specify:

1) Product number, including:

1 Edge Option:

Wood:

- 1** Square
- 5** Bevel

2) Finish code for T-support (laminate or wood).

3) Laminate edge trim for T-support (if laminate option specified).

4) Laminate worktop color (if laminate option specified).

5) Laminate edge trim for worktop (if laminate option specified).

6) Column trim color (required).

Note: Wood grained laminate worktop finishes are applied with wood grain direction side-to-side only.

Depth	Width	Number	HPL	
			A	B
Partial Height				
30"(762mm)	72"(1829mm)	XLYD-3072-JSNNP	\$ 1477.99	\$ 1778.16
	78"(1981mm)	XLYD-3078-JSNNP	1526.99	1879.31
	84"(2134mm)	XLYD-3084-JSNNP	1575.99	1980.46
	90"(2286mm)	XLYD-3090-JSNNP	1624.99	2081.61
36"(914mm)	72"(1829mm)	XLYD-3672-JSNNP	\$ 1595.59	\$2020.92
	78"(1981mm)	XLYD-3678-JSNNP	1654.39	2142.30
	84"(2134mm)	XLYD-3684-JSNNP	1713.19	2263.68
	90"(2286mm)	XLYD-3690-JSNNP	1771.99	2385.06
	96"(2438mm)	XLYD-3696-JSNNP	1830.79	2506.44
Full Height				
30"(762mm)	48"(1219mm)	XLYD-3048-JSNNF	\$ 1510.06	\$ 1601.63
	54"(1372mm)	XLYD-3054-JSNNF	1559.06	1702.78
	60"(1524mm)	XLYD-3060-JSNNF	1608.06	1803.93
	66"(1676mm)	XLYD-3066-JSNNF	1657.06	1905.08
	72"(1829mm)	XLYD-3072-JSNNF	1706.06	2006.23
	78"(1981mm)	XLYD-3078-JSNNF	1755.06	2107.38
	84"(2134mm)	XLYD-3084-JSNNF	1804.06	2208.53
	90"(2286mm)	XLYD-3090-JSNNF	1853.06	2309.68
36"(914mm)	48"(1219mm)	XLYD-3648-JSNNF	\$ 1588.46	\$ 1763.47
	54"(1372mm)	XLYD-3654-JSNNF	1647.26	1884.85
	60"(1524mm)	XLYD-3660-JSNNF	1706.06	2006.23
	66"(1676mm)	XLYD-3666-JSNNF	1764.86	2127.61
	72"(1829mm)	XLYD-3672-JSNNF	1823.66	2248.99
	78"(1981mm)	XLYD-3678-JSNNF	1882.46	2370.37
	84"(2134mm)	XLYD-3684-JSNNF	1941.26	2491.75
	90"(2286mm)	XLYD-3690-JSNNF	2000.06	2613.13
	96"(2438mm)	XLYD-3696-JSNNF	2058.86	2734.51

Convergent D-Worktop

T-Support and Column

Depth	Width	Number ①	Wood A	Wood B	
			Edge	Edge	5
			1	1	5
Partial Height					
30"(762mm)	72"(1829mm)	XZYD-3072- SNSP	\$ 3225.27	\$ 3563.94	\$ 4214.34
	78"(1981mm)	XZYD-3078- SNSP	3348.27	3697.84	4348.24
	84"(2134mm)	XZYD-3084- SNSP	3471.27	3831.74	4482.14
	90"(2286mm)	XZYD-3090- SNSP	3594.27	3965.64	4616.04
36"(914mm)	72"(1829mm)	XZYD-3672- SNSP	\$ 3520.47	\$ 3885.30	\$ 4535.70
	78"(1981mm)	XZYD-3678- SNSP	3668.07	4045.98	4696.38
	84"(2134mm)	XZYD-3684- SNSP	3815.67	4206.66	4857.06
	90"(2286mm)	XZYD-3690- SNSP	3963.27	4367.34	5017.74
	96"(2438mm)	XZYD-3696- SNSP	4110.87	4528.02	5178.42
Full Height					
30"(762mm)	48"(1219mm)	XZYD-3048- SNSF	\$ 2961.34	\$ 3256.41	\$ 3627.53
	54"(1372mm)	XZYD-3054- SNSF	3084.34	3390.31	3761.43
	60"(1524mm)	XZYD-3060- SNSF	3207.34	3524.21	3895.33
	66"(1676mm)	XZYD-3066- SNSF	3330.34	3658.11	4308.51
	72"(1829mm)	XZYD-3072- SNSF	3453.34	3792.01	4442.41
	78"(1981mm)	XZYD-3078- SNSF	3576.34	3925.91	4576.31
	84"(2134mm)	XZYD-3084- SNSF	3699.34	4059.81	4710.21
	90"(2286mm)	XZYD-3090- SNSF	3822.34	4193.71	4844.11
	36"(914mm)	48"(1219mm)	XZYD-3648- SNSF	\$ 3158.14	\$ 3470.65
54"(1372mm)		XZYD-3654- SNSF	3305.74	3631.33	4002.45
60"(1524mm)		XZYD-3660- SNSF	3453.34	3792.01	4163.13
66"(1676mm)		XZYD-3666- SNSF	3600.94	3952.69	4603.09
72"(1829mm)		XZYD-3672- SNSF	3748.54	4113.37	4763.77
78"(1981mm)		XZYD-3678- SNSF	3896.14	4274.05	4924.45
84"(2134mm)		XZYD-3684- SNSF	4043.74	4434.73	5085.13
90"(2286mm)		XZYD-3690- SNSF	4191.34	4595.41	5245.81
96"(2438mm)		XZYD-3696- SNSF	4338.94	4756.09	5406.49

Convergent P-Worktop

T-Support and Column

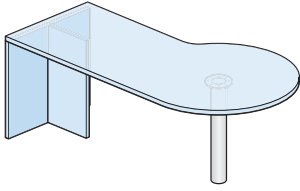

(Right-hand shown)

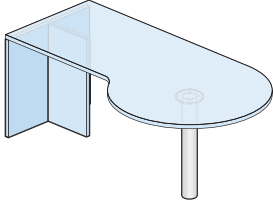

XLYP-SF
XZYP-SF
(Left-hand shown)

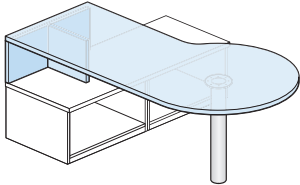

(Right-hand shown)

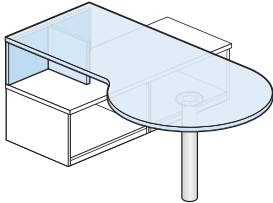

XLYP-SP
XZYP-SP
(Left-hand shown)
Class RA

Features

- Includes 1.18" (30mm) worktop, T-support end panel, column leg and column leg attachment hardware.
- High-Pressure Laminate (HPL) worktop with 3mm edgeband applied to user and visitor edges only. Ends capped with 1mm thick edgeband. All other components finished in laminate with 1mm thick edgeband.
- Worktop with a choice of profiled edge (Square or Bevel) applied to user and visitor edges.
- Double-cut veneers available with Square 3mm Radius edge only.
- Optional end panel height available on desks 72" (1829mm) or greater in width.
- 4" (102mm) column leg with 3" (76mm) adjustment.
- Shipped unassembled.

Specification Tips

- Not designed to stand alone.
- 30" (762mm)D worktop has 42" (1067mm) diameter conference end, handed with radius extending away from user.
- 36" (914mm)D worktop has 48" (1219mm) diameter conference end, handed with radius extending away from user.
- See Stack-on Application Rules in Specification Guide.
- Desk with partial height end panel to be supported on 1H modular bench.
- Accommodates separately specified center drawer.
- Separately specified grommets can be field installed in desk worktop.
- See 1H Application Rules in Specification Guide.

To Order, Specify:

1) Product number, including:

1 Edge Option:

Wood:

- 1** Square
- 5** Bevel

2 Orientation:

- L** Left-hand
- R** Right-hand

2) Finish code for T-support (laminated or wood).

3) Laminate edge trim for T-support (if laminate option specified).

4) Laminate worktop color (if laminate option specified).

5) Laminate edge trim for worktop (if laminate option specified).

6) Column trim color (required).

Note: Wood grained laminate worktop finishes are applied with wood grain direction side-to-side only.

Convergent P-Worktop

T-Support and Column

Depth	Width	Number ① ②	HPL		Wood A Edge		Wood B Edge		
			A	B	1	1	5		
HPL Partial Height									
30"(762mm)	72"(1829mm)	XLYP-3072-JS NP	\$ 1760.06	\$ 1940.23					
	78"(1981mm)	XLYP-3078-JS NP	1818.79	2003.72					
	84"(2134mm)	XLYP-3084-JS NP	1877.52	2067.21					
	90"(2286mm)	XLYP-3090-JS NP	1936.25	2130.70					
36"(914mm)	78"(1981mm)	XLYP-3678-JS NP	\$ 1927.86	\$ 2121.63					
	84"(2134mm)	XLYP-3684-JS NP	1994.98	2194.19					
	90"(2286mm)	XLYP-3690-JS NP	2062.10	2266.75					
	96"(2438mm)	XLYP-3696-JS NP	2129.22	2339.31					
HPL Full Height									
30"(762mm)	54"(1372mm)	XLYP-3054-JS NF	\$ 1797.87	\$ 1963.76					
	60"(1524mm)	XLYP-3060-JS NF	1856.60	2027.25					
	66"(1676mm)	XLYP-3066-JS NF	1915.33	2090.74					
	72"(1829mm)	XLYP-3072-JS NF	1974.06	2154.23					
	78"(1981mm)	XLYP-3078-JS NF	2032.79	2217.72					
	84"(2134mm)	XLYP-3084-JS NF	2091.52	2281.21					
	90"(2286mm)	XLYP-3090-JS NF	2150.25	2344.70					
	96"(2438mm)	XLYP-3096-JS NF	2209.25	2408.20					
36"(914mm)	66"(1676mm)	XLYP-3666-JS NF	\$ 2007.62	\$ 2190.51					
	72"(1829mm)	XLYP-3672-JS NF	2074.74	2263.07					
	78"(1981mm)	XLYP-3678-JS NF	2141.86	2335.63					
	84"(2134mm)	XLYP-3684-JS NF	2208.98	2408.19					
	90"(2286mm)	XLYP-3690-JS NF	2276.10	2480.75					
	96"(2438mm)	XLYP-3696-JS NF	2343.22	2553.31					
	Wood Partial Height								
	30"(762mm)	72"(1829mm)	XZYP-3072- S SP			\$ 3793.30	\$ 4186.81	\$ 4812.65	
78"(1981mm)		XZYP-3078- S SP			4033.96	4443.43	5069.27		
84"(2134mm)		XZYP-3084- S SP			4274.62	4700.05	5325.89		
90"(2286mm)		XZYP-3090- S SP			4515.28	4956.67	5582.51		
36"(914mm)	78"(1981mm)	XZYP-3678- S SP			\$ 4480.90	\$ 4920.01	\$ 5545.85		
	84"(2134mm)	XZYP-3684- S SP			4755.94	5213.29	5839.13		
	90"(2286mm)	XZYP-3690- S SP			5030.98	5506.57	6132.41		
	96"(2438mm)	XZYP-3696- S SP			5306.02	5799.85	6425.69		
Wood Full Height									
30"(762mm)	54"(1372mm)	XZYP-3054- S SF			\$ 3285.32	\$ 3630.95	\$ 3988.08		
	60"(1524mm)	XZYP-3060- S SF			3525.98	3887.57	4244.70		
	66"(1676mm)	XZYP-3066- S SF			3766.64	4144.19	4770.03		
	72"(1829mm)	XZYP-3072- S SF			4007.30	4400.81	5026.65		
	78"(1981mm)	XZYP-3078- S SF			4247.96	4657.43	5283.27		
	84"(2134mm)	XZYP-3084- S SF			4488.62	4914.05	5539.89		
	90"(2286mm)	XZYP-3090- S SF			4729.28	5170.67	5796.51		
	96"(2438mm)	XZYP-3096- S SF			5010.40	5506.57	6132.41		
36"(914mm)	66"(1676mm)	XZYP-3666- S SF			\$ 4144.82	\$ 4547.45	\$ 5173.29		
	72"(1829mm)	XZYP-3672- S SF			4419.86	4840.73	5466.57		
	78"(1981mm)	XZYP-3678- S SF			4694.90	5134.01	5759.85		
	84"(2134mm)	XZYP-3684- S SF			4969.94	5427.29	6053.13		
	90"(2286mm)	XZYP-3690- S SF			5244.98	5720.57	6346.41		
	96"(2438mm)	XZYP-3696- S SF			5520.02	6013.85	6639.69		

Convergent D-Worktop Column

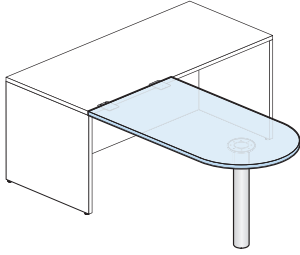

XLND-NS
XZND-NS
Class RA

Features

- Includes worktop, column base, two flat brackets and column base attachment hardware.
- 1.18”(30mm) thick high-pressure laminate (HPL) worktop with 3mm edgeband applied to user and visitor edges only.
- 1.18”(30mm) thick wood worktop with a choice of profiled edge (Square or Bevel) applied to user and visitor edges. Double-cut veneers available with Square 3mm Radius edge only.
- Attachment edge of worktop with Bevel profiled edge is coped.
- 4”(102mm) diameter column leg with 3”(76mm) adjustment.
- Shipped unassembled.

Specification Tips

- Not designed to stand alone.
- Two flat brackets to allow for attachment to modular credenza.
- Accommodates separately specified center drawer.
- Separately specified grommets can be field installed in desk worktop.

To Order, Specify:

1) Product number, including:

1 Edge Option:

Wood:

- 1** Square
- 5** Bevel

2) Finish code for worktop (laminate or wood).

3) Laminate edge trim for worktop (if laminate option specified).

4) Column trim color (required).

Height	Depth	Width	Number ①	HPL		Wood A	Wood B	
				A	B	1	1	5
HPL								
29.125”(740mm)	30”(762mm)	30”(762mm)	XLND-3030-JSNN	\$ 765.72	\$ 827.01			
		36”(914mm)	XLND-3036-JSNN	803.02	867.26			
		42”(1067mm)	XLND-3042-JSNN	840.32	907.51			
		48”(1219mm)	XLND-3048-JSNN	877.62	947.76			
		54”(1372mm)	XLND-3054-JSNN	914.92	988.01			
		60”(1524mm)	XLND-3060-JSNN	952.22	1028.26			
		66”(1676mm)	XLND-3066-JSNN	989.52	1068.51			
	72”(1829mm)	XLND-3072-JSNN	1026.82	1108.76				
	36”(914mm)	36”(914mm)	XLND-3636-JSNN	\$ 847.78	\$ 915.56			
		42”(1067mm)	XLND-3642-JSNN	892.54	963.86			
		48”(1219mm)	XLND-3648-JSNN	937.30	1012.16			
		54”(1372mm)	XLND-3654-JSNN	982.06	1060.46			
		60”(1524mm)	XLND-3660-JSNN	1026.82	1108.76			
		66”(1676mm)	XLND-3666-JSNN	1071.58	1157.06			
72”(1829mm)		XLND-3672-JSNN	1116.34	1205.36				
78”(1981mm)	XLND-3678-JSNN	1161.10	1253.66					
Wood								
29.125”(740mm)	30”(762mm)	30”(762mm)	XZND-3030- SNS			\$2029.31	\$ 2236.01	\$ 2613.54
		36”(914mm)	XZND-3036- SNS			2160.96	2381.01	2758.54
		42”(1067mm)	XZND-3042- SNS			2292.61	2526.01	2903.54
		48”(1219mm)	XZND-3048- SNS			2424.26	2671.01	3048.54
		54”(1372mm)	XZND-3054- SNS			2555.91	2816.01	3193.54
		60”(1524mm)	XZND-3060- SNS			2687.56	2961.01	3338.54
		66”(1676mm)	XZND-3066- SNS			2819.21	3106.01	3483.54
	72”(1829mm)	XZND-3072- SNS			2950.86	3251.01	3628.54	
	36”(914mm)	36”(914mm)	XZND-3636- SNS			\$ 2318.94	\$2555.01	\$ 3216.56
		42”(1067mm)	XZND-3642- SNS			2476.92	2729.01	3390.56
		48”(1219mm)	XZND-3648- SNS			2634.90	2903.01	3564.56
		54”(1372mm)	XZND-3654- SNS			2792.88	3077.01	3738.56
		60”(1524mm)	XZND-3660- SNS			2950.86	3251.01	3912.56
		66”(1676mm)	XZND-3666- SNS			3108.84	3425.01	4086.56
72”(1829mm)		XZND-3672- SNS			3266.82	3599.01	4260.56	
78”(1981mm)	XZND-3678- SNS			3424.80	3773.01	4434.56		

Convergent P-Worktop Column

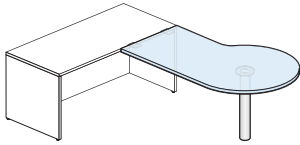

XLNP-RS
XTNP-RS
XZNP-RS
(Right-hand shown)

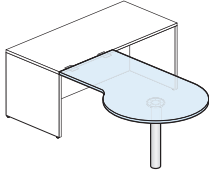

XLNP-LS
XZNP-LS
(Left-hand shown)
Class RA

Features

- Includes 1.18"(30mm) worktop, column base, two flat brackets and column base attachment hardware.
- High-Pressure Laminate (HPL) worktop with 3mm edgeband applied to user and visitor edges only.
- Wood worktop with a choice of profiled edge (Square or Bevel) applied to user and visitor edges.
- Double-cut veneers available with Square 3mm Radius edge only.
- Attachment edge of worktop is coped for Bevel profiled edges.
- 4"(102mm) diameter column leg with 3"(76mm) adjustment.
- Shipped unassembled.

Specification Tips

- Not designed to stand alone.
- Designed to be used with 2H desks/storage.
- See Stack-on Application Rules in Specification Guide.
- 30"(762mm)D worktop has 42"(1067mm) diameter conference end, handed with radius extending away from user.
- 36"(914mm)D worktop has 48"(1219mm) diameter conference end, handed with radius extending away from user.
- Designed to attach to credenzas built with modular components.
- Accommodates separately specified center drawer.
- 72"(1829mm) convergent worksurfaces and wrap-around convergent worksurfaces, panel hung, or freestanding, use WUAR-3900-PH.

To Order, Specify:

1) Product number, including:

1 Edge Option:

Wood:

- 1 Square
- 5 Bevel

2 Orientation:

- L Left-hand
- R Right-hand

2) Finish code for worktop (laminated or wood).

3) Laminate edge trim for worktop (if laminate option specified).

4) Column trim color (required).

Height	Depth	Width	Number 1 2	HPL		Wood A Edge		Wood B Edge	
				A	B	1	1	5	
HPL									
29.125"(740mm)	30"(762mm)	54"(1372mm)	XLNP-3054-JS N	\$ 1164.59	\$ 1257.73				
		60"(1524mm)	XLNP-3060-JS N	1229.27	1322.41				
		66"(1676mm)	XLNP-3066-JS N	1293.95	1387.09				
		72"(1829mm)	XLNP-3072-JS N	1358.63	1451.77				
	36"(914mm)	66"(1676mm)	XLNP-3666-JS N	\$1332.10	\$1425.24				
		72"(1829mm)	XLNP-3672-JS N	1396.78	1489.92				
		78"(1981mm)	XLNP-3678-JS N	1461.46	1554.60				
Wood									
29.125"(740mm)	30"(762mm)	54"(1372mm)	XZNP-3054- S S	\$ 3132.94	\$3450.15	\$ 3847.00			
		60"(1524mm)	XZNP-3060- S S	3254.79	3584.47	3981.32			
		66"(1676mm)	XZNP-3066- S S	3376.64	3718.79	4115.64			
		72"(1829mm)	XZNP-3072- S S	3498.49	3853.11	4249.96			
	36"(914mm)	66"(1676mm)	XZNP-3666- S S	\$ 3414.79	\$ 3763.17	\$4262.25			
		72"(1829mm)	XZNP-3672- S S	3536.64	3897.49	4396.57			
		78"(1981mm)	XZNP-3678- S S	3658.49	4031.81	4530.89			

Bridge

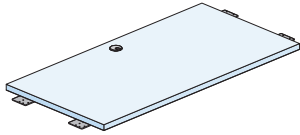

XLBF-NS
XZBF-NS

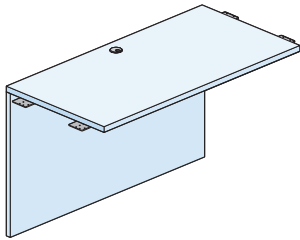

XLBF-FS
XZBF-FS
Class RA

Features

- Includes 1.18"(30mm) worksurface, optional modesty panel and attachment hardware.
- High-Pressure Laminate (HPL) worksurface with 3mm edgeband applied to user edge only; connection edges are unfinished.
- Wood worksurface with a choice of profiled edge (Square or Bevel) applied to user edges.
- Double-cut veneers available with Square 3mm Radius edge only.
- Wood worksurfaces available with choice of grain direction; side-to-side (standard) or front-to-back.
- Both attachment edges of wood veneer worksurfaces with Bevel profiled edges are coped.
- Optional 2"(51mm) grommet centered in back of worksurface.
- Grommet available with option of black or satin finish.
- Shipped unassembled.

Specification Tips

- Specified for use between single pedestal desks, desk shells and configured credenza units using modular components to create a "U-shaped" office configuration.
- Bridges with profiled edges not for use with corner units.
- See Corner Unit Application in Specification Guide.

To Order, Specify:

1) Product number, including:

1 Edge Option:

Wood:

- 1** Square
- 5** Bevel (add **\$107.19** list)

2 Grommet Option:

- Y** Grommet (add **\$187.61** list)
- N** No Grommet

3 Grain Direction (wood only):

- F** Front-to-back
- S** Side-to-side

2) Finish code for modesty (if specified).

3) Laminate edge trim for modesty (if laminate option specified).

4) Finish code for bridge (laminate or wood).

5) Edge trim for bridge (if laminate option specified).

6) Trim color for grommet (if specified).

Note: Wood grained laminate worksurface finishes are applied with wood grain direction side-to-side only.

Height	Depth	Width	Number	HPL		
				1	2	3
				A	B	
HPL — No Modesty						
29.125"(740mm)	19"(483mm)	36"(914mm)	XLBF-1936-	S	N	\$ 341.96 \$ 368.78
		42"(1067mm)	XLBF-1942-	S	N	373.88 401.84
		48"(1219mm)	XLBF-1948-	S	N	405.80 434.90
		54"(1372mm)	XLBF-1954-	S	N	437.72 467.96
		60"(1524mm)	XLBF-1960-	S	N	469.64 501.02
	24"(610mm)	36"(914mm)	XLBF-2436-	S	N	\$ 392.36 \$ 420.98
		42"(1067mm)	XLBF-2442-	S	N	432.68 462.74
		48"(1219mm)	XLBF-2448-	S	N	473.00 504.50
		54"(1372mm)	XLBF-2454-	S	N	513.32 546.26
		60"(1524mm)	XLBF-2460-	S	N	553.64 588.02
HPL — Full Modesty						
29.125"(740mm)	19"(483mm)	36"(914mm)	XLBF-1936-	S	F	\$ 975.86 \$ 1031.40
		42"(1067mm)	XLBF-1942-	S	F	1007.78 1064.46
		48"(1219mm)	XLBF-1948-	S	F	1039.70 1097.52
		54"(1372mm)	XLBF-1954-	S	F	1071.62 1130.58
		60"(1524mm)	XLBF-1960-	S	F	1103.54 1163.64
	24"(610mm)	36"(914mm)	XLBF-2436-	S	F	\$1026.26 \$1083.60
		42"(1067mm)	XLBF-2442-	S	F	1066.58 1125.36
		48"(1219mm)	XLBF-2448-	S	F	1106.90 1167.12
		54"(1372mm)	XLBF-2454-	S	F	1147.22 1208.88
		60"(1524mm)	XLBF-2460-	S	F	1187.54 1250.64

Bridge

Height	Depth	Width	Number ① ② ③	Wood	
				A	B
Wood — No Modesty					
29.125"(740mm)	19"(483mm)	36"(914mm)	XZBF-1936- S N	\$ 922.80	\$ 1016.74
		42"(1067mm)	XZBF-1942- S N	1003.74	1104.52
		48"(1219mm)	XZBF-1948- S N	1084.68	1192.30
		54"(1372mm)	XZBF-1954- S N	1165.62	1280.08
		60"(1524mm)	XZBF-1960- S N	1246.56	1367.86
	24"(610mm)	36"(914mm)	XZBF-2436- S N	\$ 1050.60	\$ 1155.34
		42"(1067mm)	XZBF-2442- S N	1152.84	1266.22
		48"(1219mm)	XZBF-2448- S N	1255.08	1377.10
		54"(1372mm)	XZBF-2454- S N	1357.32	1487.98
		60"(1524mm)	XZBF-2460- S N	1459.56	1598.86
Wood — Full Modesty					
29.125"(740mm)	19"(483mm)	36"(914mm)	XZBF-1936- S F	\$ 1635.06	\$ 1800.25
		42"(1067mm)	XZBF-1942- S F	1716.00	1888.03
		48"(1219mm)	XZBF-1948- S F	1796.94	1975.81
		54"(1372mm)	XZBF-1954- S F	1877.88	2063.59
		60"(1524mm)	XZBF-1960- S F	1958.82	2151.37
	24"(610mm)	36"(914mm)	XZBF-2436- S F	\$ 1762.86	\$ 1938.85
		42"(1067mm)	XZBF-2442- S F	1865.10	2049.73
		48"(1219mm)	XZBF-2448- S F	1967.34	2160.61
		54"(1372mm)	XZBF-2454- S F	2069.58	2271.49
		60"(1524mm)	XZBF-2460- S F	2171.82	2382.37

Corner Shell

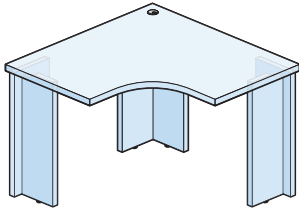

XLCN-22
XZCN-22
Class RA

Features

- Includes 1.18" (30mm) worksurface, L-supports and attachment hardware.
- High-Pressure Laminate (HPL) worksurface with 3mm edgeband applied to user edge only; connection edges are unfinished.
- Wood worksurface with a choice of profiled edge (Square or Bevel) applied to user and visitor edges.
- Double-cut veneers available with Square 3mm Radius edge only.
- Wood worksurfaces available with choice of grain direction; side-to-side (standard) or front-to-back.
- Available with No Modesty option only.
- 36" x 36" (914 x 914mm) corner available with an option of 19" (483mm) or 24" (610mm) D attachment.
- 42" x 42" (1067 x 1067mm) corner available with an option of 24" (610mm) or 30" (762mm) D attachment.
- 10" x 10" (254 x 254mm) L-support in back corner of corner shell.
- 19" (483mm) and 24" (610mm) D connection edges include 10" x 10" (254 x 254mm) L-support.
- 30" (762mm) D connection edges include 15" x 15" (381 x 381mm) L-support.
- L-supports include unfinished clearcoat integrated wireways.
- Optional 2" (51mm) grommet centered in back of worksurface.
- Grommet available with option of black or satin chrome finish.
- Glides provide 2" (51mm) adjustment range.
- Shipped unassembled.

Specification Tips

- Attachment depth may differ each side of the corner shell.
- Designed to be used against wall.
- May be used with return tops or modular worksurface.
- Corner shell cannot be used with a pre-configured return or bridge with profiled edges; can be used with Square edge only.
- See Corner Unit Applications in Specification Guide.

To Order, Specify:

1) Product number, including:

1 Edge Option:

Wood:

- 1 Square
- 5 Bevel (add \$257.88 list)

2 Grommet Option:

- Y Grommet (add \$187.61 list)
- N No Grommet

3 Attachment Depth Left:

- 1 19" (36" Corner Only)
- 2 24"
- 3 30" (42" Corner Only)

4 Attachment Depth Right:

- 1 19" (36" Corner Only)
- 2 24"
- 3 30" (42" Corner Only)

5 Grain Direction (wood only):

- L Left-hand
- R Right-hand

- 2) Finish code for lower supports (laminite or wood).
- 3) Laminate edge trim color for lower supports (if laminate option specified).
- 4) Laminate worksurface color (if laminate option specified).
- 5) Laminate edge trim for worksurface (if laminate option specified).
- 6) Trim color for grommet (if specified).

Note: Wood grained laminate worksurface finishes are applied with wood grain direction side-to-side only.

Height	Depth	Width	Number 1 2 3 4 5	HPL		Wood	
				A	B	A	B
HPL							
29.125" (740mm)	36" (914mm)	36" (914mm)	XLCN-3636-JS ■ ■ ■ D	\$1986.90	\$2128.87		
	42" (1067mm)	42" (1067mm)	XLCN-4242-JS ■ ■ ■ D	1993.54	2135.51		
Wood							
29.125" (740mm)	36" (914mm)	36" (914mm)	XZCN-3636- ■ S ■ ■ ■ ■ ■			\$ 3153.82	\$3509.66
	42" (1067mm)	42" (1067mm)	XZCN-4242- ■ S ■ ■ ■ ■ ■			3359.74	3736.25

Return Top

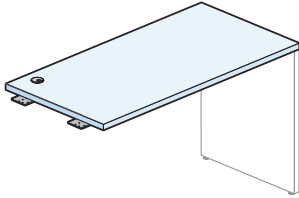

XLBR-SR
XZBR-SR
(Right shown)

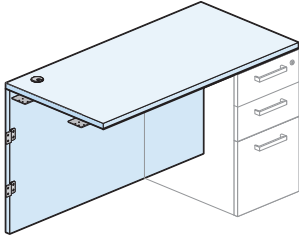

XLBR-SR
XZBR-SR
(Right shown)
Class RA

Features

- Includes 1.18" (30mm) worksurface, optional modesty panel and attachment hardware.
- High-Pressure Laminate (HPL) worksurface with 3mm edgeband applied to user edge only; connection edge unfinished. End capped with 1 mm thick edgeband.
- Wood worksurface with a choice of profiled edge (Square or Bevel) applied to user edge.
- Double-cut veneers available with Square 3mm Radius edge only.
- Optional 2" (51mm) grommet.
- Grommet available with option of black or satin finish.
- Includes one coped attachment edge for worksurfaces with Bevel profiled edges.
- Wood worksurfaces available with choice of grain direction; side-to-side or front-to-back.
- Optional modesty panel is .75" (19mm) thick; finished both sides.
- Shipped unassembled.

Specification Tips

- Orientation option is based on storage placement not coped edge.
- Not for free-standing application.
- May be used between single pedestal desk or convergent and corner shell as a bridge.
- Connects to separately specified end panel or attached storage unit for use as a return.
- See Corner Unit Application in Specification Guide.

To Order, Specify:

1) Product number, including:

1 Edge Option:

Wood:

- 1 Square
- 5 Bevel (add \$121.61 list)

2 Grommet Option:

- Y Grommet (add \$187.61 list)
- N No Grommet

3 Modesty Option:

- F Full Height (add \$670.08 list)
- N No Modesty

4 Grain Direction (wood only):

- F Front-to-back
- S Side-to-side

5 Orientation:

- L Left
- R Right

2) Finish code for modesty (if specified).

3) Laminate edge trim color for modesty (if specified).

4) Finish code for return top (laminated or wood).

5) Edge trim for return top (if laminate option specified).

6) Trim color for grommet (if specified).

Note: Wood grained laminate worksurface finishes are applied with wood grain direction side-to-side only.

Height	Depth	Width	Number ①②③④⑤	HPL		Wood	
				A	B	A	B
HPL							
29.125" (740mm)	19" (483mm)	36" (914mm)	XLBR-1936-JS ■ ■ N ■	\$ 612.61	\$ 661.53		
		42" (1067mm)	XLBR-1942-JS ■ ■ N ■	662.77	715.11		
		48" (1219mm)	XLBR-1948-JS ■ ■ N ■	712.93	768.69		
		54" (1372mm)	XLBR-1954-JS ■ ■ N ■	763.09	822.27		
		60" (1524mm)	XLBR-1960-JS ■ ■ N ■	813.25	875.85		
	24" (610mm)	36" (914mm)	XLBR-2436-JS ■ ■ N ■	\$ 691.81	\$ 746.13		
		42" (1067mm)	XLBR-2442-JS ■ ■ N ■	755.17	813.81		
		48" (1219mm)	XLBR-2448-JS ■ ■ N ■	818.53	881.49		
		54" (1372mm)	XLBR-2454-JS ■ ■ N ■	881.89	949.17		
		60" (1524mm)	XLBR-2460-JS ■ ■ N ■	945.25	1016.85		
Wood							
29.125" (740mm)	19" (483mm)	36" (914mm)	XZBR-1936- ■ S ■ ■ ■ ■			\$ 932.36	\$1038.93
		42" (1067mm)	XZBR-1942- ■ S ■ ■ ■ ■			1024.70	1141.53
		48" (1219mm)	XZBR-1948- ■ S ■ ■ ■ ■			1117.04	1244.13
		54" (1372mm)	XZBR-1954- ■ S ■ ■ S ■			1209.38	1346.73
		60" (1524mm)	XZBR-1960- ■ S ■ ■ S ■			1301.72	1449.33
	24" (610mm)	36" (914mm)	XZBR-2436- ■ S ■ ■ ■ ■			\$1078.16	\$1200.93
		42" (1067mm)	XZBR-2442- ■ S ■ ■ ■ ■			1194.80	1330.53
		48" (1219mm)	XZBR-2448- ■ S ■ ■ ■ ■			1311.44	1460.13
		54" (1372mm)	XZBR-2454- ■ S ■ ■ S ■			1428.08	1589.73
		60" (1524mm)	XZBR-2460- ■ S ■ ■ S ■			1544.72	1719.33

Height Adjustable Credenza Desk

T-Leg Base

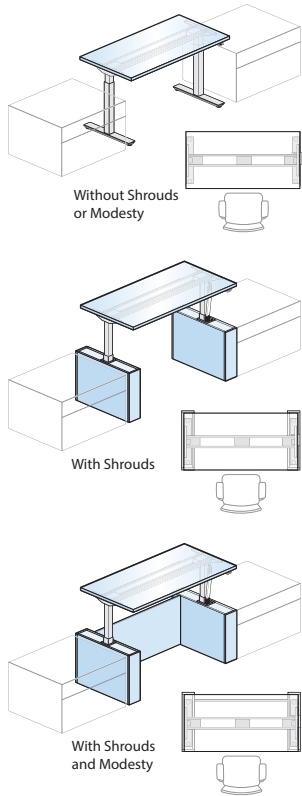

XLZR-2460
XZZR-2460
Class RA

Features

- Includes 1.18" (30mm) thick top, T-leg base assembly, wire management clips, height adjustment mechanism and hardware.
 - Pair of Shrouds with two bezels, cable chain and attachment hardware
 - Pair of Shrouds and Modesty with two bezels, cable chain, modesty and attachment hardware.
- Actual top width and depth is 2" (51mm) less than nominal width and depth.
- Height adjustment touch pad actuator options:
 - Single Stage Touch Pad Actuator available in Standard (E) up/down movement or Programmable (R) providing four different up/down programmed heights. Provides 27" (686mm) to 46" (1168mm) continuous height adjustment range.
- Touch Pad Actuator:
 - Can be mounted on left or right side of table; predrilled for field installed and field changeable.
 - Touch pad actuator has touch pad controls and standard with black housing.
 - Control box is field installed and standard with black housing.
- Height adjustment: 1" (25mm) per 1.6 seconds.
 - Telescoping base tubes and J-rails. Telescoping base tubes will match base trim color. Smooth paint trim will match. Textured paint will be complimentary.
- Includes: 9.5" (241mm) long black power cord with NEMA 5-15P plug to the building.
- Base includes leg assembly and foot; available in painted trim colors.
- Glides have .5" (13mm) height adjustment and are standard in black.
- Grommets are available for field installation; separately specified. Specification Guide.

Specification Tips

- Top is designed to allow pinch point clearance to accommodate cables. The undersized top provides:
 - 1" (25mm) gap along each side of the top between the adjacent furnishings or building architecture.
 - 2" (51mm) gap along the back of the top between the building architecture to accommodate cables and a tackboard above the top.
- Pinch point should be adjusted when using spacers and a tackboard.
- Separately specified Reinforcement Channel or Bar are not required.
- A pair of shrouds are optional; a shroud is an aesthetic cover which conceals a Height Adjustable T-Leg.
- For a Height Adjustable Credenza Desk with Shrouds:
 - See options below; select the catalog number for a pair of shrouds.
 - A modesty panel for use with shrouds may be specified as a functional option; modesty not for use with exposed T-Legs.
 - Shroud base material to match worksurface material.
- Height Adjustable Credenza Desk without shrouds may be used with a separately specified Adaptable Modesty Panel.
- Height Adjustable Credenza Desk is not for use with separately specified Shroud for use with Adjustable T-Legs; dimensionally different shrouds.

Electrical:

- For use with separately specified electrical components: (Note: All of the options shown below require field cut mounting holes in the top. Ensure placement provides adequate clearance for table understructure.)
 - Flush Mounted Power Module Cord for Height Adjustable or Hardwire
 - Enhanced Power Module Corded or Hardwire with mounting bracket
 - Flip Top Unit Corded or Hardwire
 - Bezel Utility Module
- Height Adjustable Credenza Desk is not for use with AKP's, suspended or attached pedestals.
- Total lifting capacity of table is 250 lbs. including surface; applied weight should be evenly distributed.

To Order, Specify:

1) Product number, including:

1 Surface Option:

- L** Laminate
- Z** Wood

2 Edge Option:

- J** Edgeband (Laminate only)
- 1** Square (Wood only)
- 5** Bevel (Wood only)

3 Height Adjustment Actuator Option:

Single Stage:

- E** Standard
- R** Programmable (add \$196.78 list)

4 Lower Material:

(Lower Material always matches top Material)

(Shrouds only or Shrouds and Modesty Panel)

- L** Laminate
- W** Wood (lower material shroud and modesty)

No Shroud or Modesty:

- 2) Laminate surface color or wood finish color for top material.
- 3) Edge trim color (laminate only).
- 4) Trim color for base

With Shroud:

- 2) Laminate surface color or wood finish color for Shroud.
- 3) Edge trim color (laminate only).
- 4) Laminate surface color or wood finish for top material.
- 5) Edge trim color (laminate only).
- 6) Trim color for base (including bezel).

With Shroud and Modesty:

- 2) Laminate surface color or wood finish color for Shroud and Modesty.
- 3) Edge trim color (laminate only).
- 4) Laminate surface color or wood finish for top material.
- 5) Edge trim color (laminate only).
- 6) Trim color for base (including bezel).

Note: \$59.41 upcharge (list) for Metallic and accent trim colors.

Table Depth and Base	Screens	Monitor Arms
29"(737mm) T-Leg Glides	Yes	Yes (50 lbs max)
35"(889mm) T-Leg Glides	Yes	Yes (50 lbs max)
41"(1041mm) T-Leg Glides	Yes	Yes (50 lbs max)

Height Adjustable Credenza Desk

T-Leg Base

Depth	Width	Number			HPL		Wood A	Wood B	5,6,7		
		①	②	③④	A	B	Edge 1	Edge 1			
Without Shrouds or Modesty											
24"(610mm)	60"(1524mm)	X	ZR-2460-	SNNB		N	\$ 2518.56	\$2668.93	\$ 3935.01	\$ 4013.93	\$ 4160.79
	66"(1676mm)	X	ZR-2466-	SNNB		N	2558.96	2709.33	3995.69	4075.77	4222.63
	72"(1829mm)	X	ZR-2472-	SNNB		N	2599.36	2749.73	4056.37	4137.61	4284.47
30"(762mm)	60"(1524mm)	X	ZR-3060-	SNNB		N	\$ 2619.56	\$2769.93	\$4086.71	\$ 4168.53	\$ 4315.39
	66"(1676mm)	X	ZR-3066-	SNNB		N	2670.06	2820.43	4162.56	4245.83	4392.69
	72"(1829mm)	X	ZR-3072-	SNNB		N	2720.56	2870.93	4238.41	4323.13	4469.99
With Shrouds and no Modesty											
24"(610mm)	60"(1524mm)	X	ZR-2460-	SNSB		N	\$5093.19	\$5449.50	\$ 8393.11	\$ 8739.52	\$ 8886.38
	66"(1676mm)	X	ZR-2466-	SNSB		N	5133.59	5489.90	8453.79	8801.36	8948.22
	72"(1829mm)	X	ZR-2472-	SNSB		N	5173.99	5530.30	8514.47	8863.20	9010.06
30"(762mm)	60"(1524mm)	X	ZR-3060-	SNSB		N	\$ 5194.19	\$5550.50	\$8544.81	\$8894.12	\$9040.98
	66"(1676mm)	X	ZR-3066-	SNSB		N	5244.69	5601.00	8620.66	8971.42	9118.28
	72"(1829mm)	X	ZR-3072-	SNSB		N	5295.19	5651.50	8696.51	9048.72	9195.58
With Shrouds and Modesty											
24"(610mm)	60"(1524mm)	X	ZR-2460-	SNSB		M	\$ 5475.02	\$5833.95	\$ 8742.24	\$9088.65	\$ 9235.51
	66"(1676mm)	X	ZR-2466-	SNSB		M	5515.42	5874.35	8802.92	9150.49	9297.35
	72"(1829mm)	X	ZR-2472-	SNSB		M	5555.82	5914.75	8863.60	9212.33	9359.19
30"(762mm)	60"(1524mm)	X	ZR-3060-	SNSB		M	\$ 5576.02	\$5934.95	\$8893.94	\$9243.25	\$9390.11
	66"(1676mm)	X	ZR-3066-	SNSB		M	5626.52	5985.45	8969.79	9320.55	9467.41
	72"(1829mm)	X	ZR-3072-	SNSB		M	5677.02	6035.95	9045.64	9397.85	9544.71

Vertical Storage Unit

1H Open

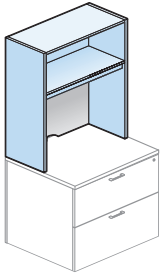

30" and 36" widths

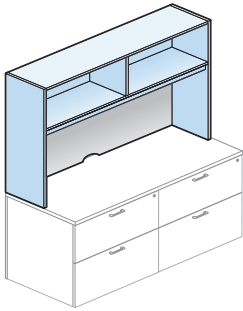

42"-72" widths

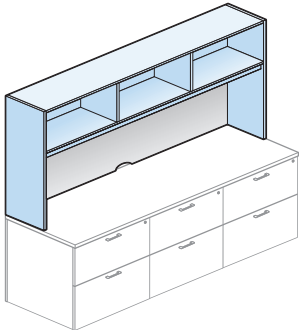

78"-96" widths

X4UL-NN
X4UD-NN
X6UL-NN
X6UD-NN

Class RA

Features

- Includes 2"(51mm) integrated light valance, vertical supports and attachment material. 23.375"(594mm) clearance between top of worksurface and bottom of light valance.
- Standard unfinished two-piece back.
- The underside of the cabinet and front of lower section:
 - High-Pressure Laminate - the underside of the cabinet and front of lower section is finished.
 - Wood - the underside of the cabinet is finished, the lower section is finished with backer sealer (black).
- Unfinished clearcoat wireway scallop in bottom center of back panel.
- Shipped assembled.

Specification Tips

- Not for use on a freestanding or standalone desk.
- Designed to stack on equal width credenza, 2H storage cabinet or 2H lateral file. Refer to Stack-on Application Rules in Specification Guide.
- Accommodates separately specified tackboards and lighting accessories. Tackboard will block the ability to drop cords down or bring power to the surface. Use field installed grommets for power access.
- Aligns with 5H storage units.
- Wood units are not designed for applications where the back of unit is visible.

To Order, Specify:

- 1) Product number.
- 2) Finish code (laminate or wood).
- 3) Laminate edge trim color (if laminate specified).

Vertical Storage Unit

1H Open

Nominal Height	Actual Height	Depth	Width	Number	HPL	
					A	B
HPL — Letter Depth						
40"(1016mm)	39.875"(1013mm)	14"(356mm)	30"(762mm)	X5UL-4030-NSNN	\$ 1595.13	\$ 1657.68
		14"(356mm)	36"(914mm)	X5UL-4036-NSNN	1712.42	1784.34
		14"(356mm)	42"(1067mm)	X5UL-4042-NSNN	1846.92	1928.21
		14"(356mm)	48"(1219mm)	X5UL-4048-NSNN	1964.21	2054.87
		14"(356mm)	54"(1372mm)	X5UL-4054-NSNN	2081.50	2181.53
		14"(356mm)	60"(1524mm)	X5UL-4060-NSNN	2198.79	2308.19
		14"(356mm)	66"(1676mm)	X5UL-4066-NSNN	2316.08	2434.85
		14"(356mm)	72"(1829mm)	X5UL-4072-NSNN	2433.37	2561.51
		14"(356mm)	78"(1981mm)	X5UL-4078-NSNN	2567.87	2705.38
		14"(356mm)	84"(2134mm)	X5UL-4084-NSNN	2685.16	2832.04
		14"(356mm)	90"(2286mm)	X5UL-4090-NSNN	2802.45	2958.70
		14"(356mm)	96"(2438mm)	X5UL-4096-NSNN	2919.74	3085.36

HPL — Legal Depth						
40"(1016mm)	39.875"(1013mm)	16.5"(419mm)	30"(762mm)	X5UD-4030-NSNN	\$ 1751.51	\$ 1826.56
		16.5"(419mm)	36"(914mm)	X5UD-4036-NSNN	1868.80	1953.22
		16.5"(419mm)	42"(1067mm)	X5UD-4042-NSNN	2003.30	2097.09
		16.5"(419mm)	48"(1219mm)	X5UD-4048-NSNN	2120.59	2223.75
		16.5"(419mm)	54"(1372mm)	X5UD-4054-NSNN	2237.88	2350.41
		16.5"(419mm)	60"(1524mm)	X5UD-4060-NSNN	2355.17	2477.07
		16.5"(419mm)	66"(1676mm)	X5UD-4066-NSNN	2472.46	2603.73
		16.5"(419mm)	72"(1829mm)	X5UD-4072-NSNN	2589.75	2730.39
		16.5"(419mm)	78"(1981mm)	X5UD-4078-NSNN	2724.25	2874.26
		16.5"(419mm)	84"(2134mm)	X5UD-4084-NSNN	2841.54	3000.92
		16.5"(419mm)	90"(2286mm)	X5UD-4090-NSNN	2958.83	3127.58
		16.5"(419mm)	96"(2438mm)	X5UD-4096-NSNN	3076.12	3254.24

Nominal Height	Actual Height	Depth	Width	Number	Wood	
					A	B
Wood — Letter Depth						
40"(1016mm)	39.875"(1013mm)	14"(356mm)	30"(762mm)	X4UL-4030-NSNN	\$ 2220.69	\$ 2358.31
		14"(356mm)	36"(914mm)	X4UL-4036-NSNN	2400.54	2552.70
		14"(356mm)	42"(1067mm)	X4UL-4042-NSNN	2597.60	2764.30
		14"(356mm)	48"(1219mm)	X4UL-4048-NSNN	2777.45	2958.69
		14"(356mm)	54"(1372mm)	X4UL-4054-NSNN	2957.30	3153.08
		14"(356mm)	60"(1524mm)	X4UL-4060-NSNN	3137.15	3347.47
		14"(356mm)	66"(1676mm)	X4UL-4066-NSNN	3317.00	3541.86
		14"(356mm)	72"(1829mm)	X4UL-4072-NSNN	3496.85	3736.25
		14"(356mm)	78"(1981mm)	X4UL-4078-NSNN	3693.91	3947.85
		14"(356mm)	84"(2134mm)	X4UL-4084-NSNN	3873.76	4142.24
		14"(356mm)	90"(2286mm)	X4UL-4090-NSNN	4053.61	4336.63
		14"(356mm)	96"(2438mm)	X4UL-4096-NSNN	4233.46	4531.02

Wood — Legal Depth						
40"(1016mm)	39.875"(1013mm)	16.5"(419mm)	30"(762mm)	X4UD-4030-NSNN	\$ 2431.82	\$ 2590.52
		16.5"(419mm)	36"(914mm)	X4UD-4036-NSNN	2611.67	2784.91
		16.5"(419mm)	42"(1067mm)	X4UD-4042-NSNN	2808.73	2996.51
		16.5"(419mm)	48"(1219mm)	X4UD-4048-NSNN	2988.58	3190.90
		16.5"(419mm)	54"(1372mm)	X4UD-4054-NSNN	3168.43	3385.29
		16.5"(419mm)	60"(1524mm)	X4UD-4060-NSNN	3348.28	3579.68
		16.5"(419mm)	66"(1676mm)	X4UD-4066-NSNN	3528.13	3774.07
		16.5"(419mm)	72"(1829mm)	X4UD-4072-NSNN	3707.98	3968.46
		16.5"(419mm)	78"(1981mm)	X4UD-4078-NSNN	3905.04	4180.06
		16.5"(419mm)	84"(2134mm)	X4UD-4084-NSNN	4084.89	4374.45
		16.5"(419mm)	90"(2286mm)	X4UD-4090-NSNN	4264.74	4568.84
		16.5"(419mm)	96"(2438mm)	X4UD-4096-NSNN	4444.59	4763.23

Vertical Storage Unit

2H Open

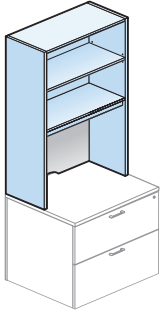

30" and 36" widths

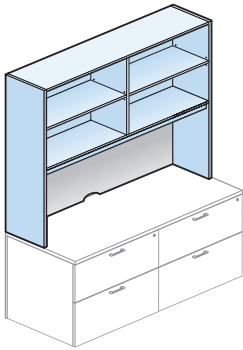

42"-72" widths

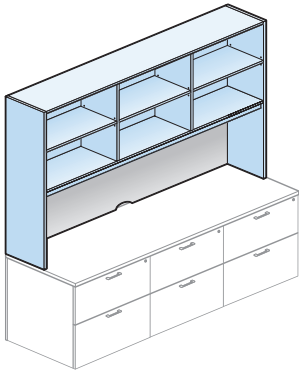

78"-96" widths
 X4UL-NN
 X4UD-NN
 X5UL-NN
 X5UD-NN
 Class RA

Features

- Includes storage cabinet(s) with 2" (51mm) integrated light valance, one adjustable shelf, vertical supports and attachment material.
- 23.375" (594mm) clearance between top of worksurface and bottom of light valance.
- Standard unfinished two-piece back.
- The underside of the cabinet and front of lower section:
 - High-Pressure Laminate - the underside of the cabinet and front of lower section is finished.
 - Wood - the underside of the cabinet is finished, the lower section is unfinished.
- One interior .75" (19mm) wood shelf with ±1.25" (32mm) adjustment range.
- Unfinished clearcoat wireway scallop in bottom center of back panel.
- Shipped assembled.

Specification Tips

- Not for use on a freestanding or standalone desk.
- Designed to stack on equal width credenza, 2H storage cabinet or 2H lateral file. Refer to Stack-on Application Rules in Specification Guide.
- Accommodates separately specified tackboards and lighting accessories. Tackboard will block the ability to drop cords down or bring power to the surface. Use field installed grommets for power access.
- Aligns with 6H storage units.
- Wood units are not designed for applications where the back of unit is visible.

To Order, Specify:

- 1) Product number.
- 2) Finish code (laminated or wood).
- 3) Laminate edge trim color (if laminate specified).

Vertical Storage Unit

2H Open

Normal Height	Actual Height	Depth	Width	Number	HPL	
					A	B
HPL — Letter Depth						
52"(1321mm)	52.5"(1334mm)	14"(356mm)	30"(762mm)	X5UL-5230-NSNN	\$ 1853.18	\$ 1936.05
		14"(356mm)	36"(914mm)	X5UL-5236-NSNN	2006.46	2101.80
		14"(356mm)	42"(1067mm)	X5UL-5242-NSNN	2176.95	2284.76
		14"(356mm)	48"(1219mm)	X5UL-5248-NSNN	2330.23	2450.51
		14"(356mm)	54"(1372mm)	X5UL-5254-NSNN	2483.51	2616.26
		14"(356mm)	60"(1524mm)	X5UL-5260-NSNN	2636.79	2782.01
		14"(356mm)	66"(1676mm)	X5UL-5266-NSNN	2790.07	2947.76
		14"(356mm)	72"(1829mm)	X5UL-5272-NSNN	2943.35	3113.51
		14"(356mm)	78"(1981mm)	X5UL-5278-NSNN	3113.84	3296.47
		14"(356mm)	84"(2134mm)	X5UL-5284-NSNN	3267.12	3462.22
		14"(356mm)	90"(2286mm)	X5UL-5290-NSNN	3420.40	3627.97
		14"(356mm)	96"(2438mm)	X5UL-5296-NSNN	3573.68	3793.72

HPL — Legal Depth						
52"(1321mm)	52.5"(1334mm)	16.5"(419mm)	30"(762mm)	X5UD-5230-NSNN	\$2009.56	\$ 2104.93
		16.5"(419mm)	36"(914mm)	X5UD-5236-NSNN	2162.84	2270.68
		16.5"(419mm)	42"(1067mm)	X5UD-5242-NSNN	2333.33	2453.64
		16.5"(419mm)	48"(1219mm)	X5UD-5248-NSNN	2486.61	2619.39
		16.5"(419mm)	54"(1372mm)	X5UD-5254-NSNN	2639.89	2785.14
		16.5"(419mm)	60"(1524mm)	X5UD-5260-NSNN	2793.17	2950.89
		16.5"(419mm)	66"(1676mm)	X5UD-5266-NSNN	2946.45	3116.64
		16.5"(419mm)	72"(1829mm)	X5UD-5272-NSNN	3099.73	3282.39
		16.5"(419mm)	78"(1981mm)	X5UD-5278-NSNN	3270.22	3465.35
		16.5"(419mm)	84"(2134mm)	X5UD-5284-NSNN	3423.50	3631.10
		16.5"(419mm)	90"(2286mm)	X5UD-5290-NSNN	3576.78	3796.85
		16.5"(419mm)	96"(2438mm)	X5UD-5296-NSNN	3730.06	3962.60

Normal Height	Actual Height	Depth	Width	Number	Wood	
					A	B
Wood — Letter Depth						
52"(1321mm)	52.5"(1334mm)	14"(356mm)	30"(762mm)	X4UL-5230-NSNN	\$ 2611.67	\$ 2788.37
		14"(356mm)	36"(914mm)	X4UL-5236-NSNN	2846.25	3042.89
		14"(356mm)	42"(1067mm)	X4UL-5242-NSNN	3098.04	3314.62
		14"(356mm)	48"(1219mm)	X4UL-5248-NSNN	3332.62	3569.14
		14"(356mm)	54"(1372mm)	X4UL-5254-NSNN	3567.20	3823.66
		14"(356mm)	60"(1524mm)	X4UL-5260-NSNN	3801.78	4078.18
		14"(356mm)	66"(1676mm)	X4UL-5266-NSNN	4036.36	4332.70
		14"(356mm)	72"(1829mm)	X4UL-5272-NSNN	4270.94	4587.22
		14"(356mm)	78"(1981mm)	X4UL-5278-NSNN	4522.73	4858.95
		14"(356mm)	84"(2134mm)	X4UL-5284-NSNN	4757.31	5113.47
		14"(356mm)	90"(2286mm)	X4UL-5290-NSNN	4991.89	5367.99
		14"(356mm)	96"(2438mm)	X4UL-5296-NSNN	5226.47	5622.51

Wood — Legal Depth						
52"(1321mm)	52.5"(1334mm)	16.5"(419mm)	30"(762mm)	X4UD-5230-NSNN	\$2822.80	\$3020.58
		16.5"(419mm)	36"(914mm)	X4UD-5236-NSNN	3057.38	3275.10
		16.5"(419mm)	42"(1067mm)	X4UD-5242-NSNN	3309.17	3546.83
		16.5"(419mm)	48"(1219mm)	X4UD-5248-NSNN	3543.75	3801.35
		16.5"(419mm)	54"(1372mm)	X4UD-5254-NSNN	3778.33	4055.87
		16.5"(419mm)	60"(1524mm)	X4UD-5260-NSNN	4012.91	4310.39
		16.5"(419mm)	66"(1676mm)	X4UD-5266-NSNN	4247.49	4564.91
		16.5"(419mm)	72"(1829mm)	X4UD-5272-NSNN	4482.07	4819.43
		16.5"(419mm)	78"(1981mm)	X4UD-5278-NSNN	4733.86	5091.16
		16.5"(419mm)	84"(2134mm)	X4UD-5284-NSNN	4968.44	5345.68
		16.5"(419mm)	90"(2286mm)	X4UD-5290-NSNN	5203.02	5600.20
		16.5"(419mm)	96"(2438mm)	X4UD-5296-NSNN	5437.60	5854.72

Vertical Storage Unit

1H Hinged Doors

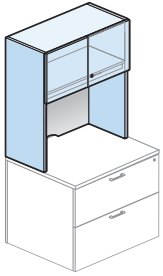

30" and 36" widths
X4VL-NW
X4VD-NW
X5VL-NL
X5VD-NL

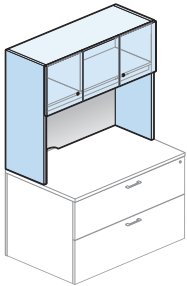

42"-54" widths
X4VL-LW
X4VD-LW
X5VL-LL
X5VD-LL

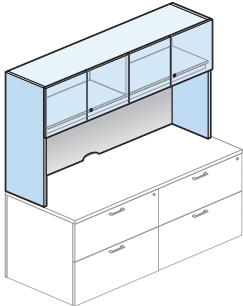

60"-72" widths
X4VL-NW
X4VD-NW
X5VL-NL
X5VD-NL

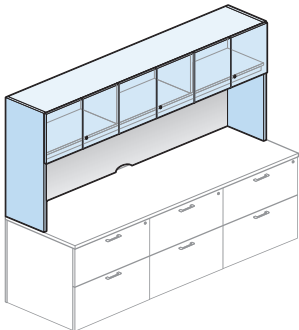

78"-96" widths
X4VL-NW
X4VD-NW
X5VL-NL
X5VD-NL
Class RA

Features

- Includes storage cabinet(s) with hinged doors, 2"(51mm) integrated light valance, vertical supports and attachment material.
- 42"(1067mm), 48"(1219mm) and 54"(1372mm)W units available with choice of left or right door swing for single door.
- Optional locks available; each pair of doors and each single door lock separately.
- Common keys within each unit.
- Lock plug is available in black or chrome.
- For lock options, refer to Lock Program section of the Accessories Price List.
- 23.375"(594mm) clearance between top of worksurface and bottom of light valance.
- Standard unfinished two-piece back.
- The underside of the cabinet and front of lower section:
 - High-Pressure Laminate - the underside of the cabinet and front of lower section is finished.
 - Wood - the underside of the cabinet is finished, the lower section is unfinished.
- Unfinished clearcoat wireway scallop in bottom center of back panel.
- Shipped assembled.

Specification Tips

- Not for use on a freestanding or standalone desk.
- Designed to stack on equal width credenza, 2H storage cabinet or 2H lateral file. Refer to Stack-on Application Rules in Specification Guide.
- Accommodates separately specified tackboards and lighting accessories. Tackboard will block the ability to drop cords down or bring power to the surface. Use field installed grommets for power access.
- Aligns with 5H storage units.
- Wood units are not designed for applications where the back of unit is visible.

To Order, Specify:

1) Product number, including:

1 Lock Option:

- N** No Lock
- L** Lock
 - 30"-36" (add **\$177.50** list)
 - 42"-72" (add **\$355.01** list)
 - 78"-96" (add **\$532.52** list)

2 Single Door Swing Orientation:
(42", 48" and 54"W only)

- L** Left-hand
- R** Right-hand

- 2) Finish code (laminated or wood).
- 3) Laminate edge trim color (if laminate specified).
- 4) Trim color for lock (if specified).

Vertical Storage Unit

1H Hinged Doors

Nominal Height	Actual Height	Depth	Width	Number ① ②	HPL	
					A	B
HPL — Letter Depth						
40"(1016mm)	39.9"(1013mm)	14.8"(376mm)	30"(762mm)	X5VL-4030- SNL	\$ 1978.28	\$ 2071.49
		14.8"(376mm)	36"(914mm)	X5VL-4036- SNL	2113.88	2218.01
		14.8"(376mm)	42"(1067mm)	X5VL-4042- S L	2266.69	2381.74
		14.8"(376mm)	48"(1219mm)	X5VL-4048- S L	2402.29	2528.26
		14.8"(376mm)	54"(1372mm)	X5VL-4054- S L	2537.89	2674.78
		14.8"(376mm)	60"(1524mm)	X5VL-4060- SNL	2673.49	2821.30
		14.8"(376mm)	66"(1676mm)	X5VL-4066- SNL	2809.09	2967.82
		14.8"(376mm)	72"(1829mm)	X5VL-4072- SNL	2944.69	3114.34
		14.8"(376mm)	78"(1981mm)	X5VL-4078- SNL	3097.50	3278.07
		14.8"(376mm)	84"(2134mm)	X5VL-4084- SNL	3233.10	3424.59
		14.8"(376mm)	90"(2286mm)	X5VL-4090- SNL	3368.70	3571.11
		14.8"(376mm)	96"(2438mm)	X5VL-4096- SNL	3504.30	3717.63

HPL — Legal Depth						
40"(1016mm)	39.9"(1013mm)	17.3"(439mm)	30"(762mm)	X5VD-4030- SNL	\$ 2134.66	\$ 2240.37
		17.3"(439mm)	36"(914mm)	X5VD-4036- SNL	2270.26	2386.89
		17.3"(439mm)	42"(1067mm)	X5VD-4042- S L	2423.07	2550.62
		17.3"(439mm)	48"(1219mm)	X5VD-4048- S L	2558.67	2697.14
		17.3"(439mm)	54"(1372mm)	X5VD-4054- S L	2694.27	2843.66
		17.3"(439mm)	60"(1524mm)	X5VD-4060- SNL	2829.87	2990.18
		17.3"(439mm)	66"(1676mm)	X5VD-4066- SNL	2965.47	3136.70
		17.3"(439mm)	72"(1829mm)	X5VD-4072- SNL	3101.07	3283.22
		17.3"(439mm)	78"(1981mm)	X5VD-4078- SNL	3253.88	3446.95
		17.3"(439mm)	84"(2134mm)	X5VD-4084- SNL	3389.48	3593.47
		17.3"(439mm)	90"(2286mm)	X5VD-4090- SNL	3525.08	3739.99
		17.3"(439mm)	96"(2438mm)	X5VD-4096- SNL	3660.68	3886.51

Nominal Height	Actual Height	Depth	Width	Number ① ②	HPL	
					A	B
Wood — Letter Depth						
40"(1016mm)	39.9"(1013mm)	14.8"(376mm)	30"(762mm)	X4VL-4030- SNW	\$ 2846.25	\$ 3126.18
		14.8"(376mm)	36"(914mm)	X4VL-4036- SNW	3054.26	3354.57
		14.8"(376mm)	42"(1067mm)	X4VL-4042- S W	3279.48	3600.17
		14.8"(376mm)	48"(1219mm)	X4VL-4048- S W	3487.49	3828.56
		14.8"(376mm)	54"(1372mm)	X4VL-4054- S W	3695.50	4056.95
		14.8"(376mm)	60"(1524mm)	X4VL-4060- SNW	3903.51	4285.34
		14.8"(376mm)	66"(1676mm)	X4VL-4066- SNW	4111.52	4513.73
		14.8"(376mm)	72"(1829mm)	X4VL-4072- SNW	4319.53	4742.12
		14.8"(376mm)	78"(1981mm)	X4VL-4078- SNW	4544.75	4987.72
		14.8"(376mm)	84"(2134mm)	X4VL-4084- SNW	4752.76	5216.11
		14.8"(376mm)	90"(2286mm)	X4VL-4090- SNW	4960.77	5444.50
		14.8"(376mm)	96"(2438mm)	X4VL-4096- SNW	5168.78	5672.89

Wood — Legal Depth						
40"(1016mm)	39.9"(1013mm)	17.3"(439mm)	30"(762mm)	X4VD-4030- SNW	\$ 3057.38	\$ 3358.39
		17.3"(439mm)	36"(914mm)	X4VD-4036- SNW	3265.39	3586.78
		17.3"(439mm)	42"(1067mm)	X4VD-4042- S W	3490.61	3832.38
		17.3"(439mm)	48"(1219mm)	X4VD-4048- S W	3698.62	4060.77
		17.3"(439mm)	54"(1372mm)	X4VD-4054- S W	3906.63	4289.16
		17.3"(439mm)	60"(1524mm)	X4VD-4060- SNW	4114.64	4517.55
		17.3"(439mm)	66"(1676mm)	X4VD-4066- SNW	4322.65	4745.94
		17.3"(439mm)	72"(1829mm)	X4VD-4072- SNW	4530.66	4974.33
		17.3"(439mm)	78"(1981mm)	X4VD-4078- SNW	4755.88	5219.93
		17.3"(439mm)	84"(2134mm)	X4VD-4084- SNW	4963.89	5448.32
		17.3"(439mm)	90"(2286mm)	X4VD-4090- SNW	5171.90	5676.71
		17.3"(439mm)	96"(2438mm)	X4VD-4096- SNW	5379.91	5905.10

Vertical Storage Unit

2H Hinged Doors

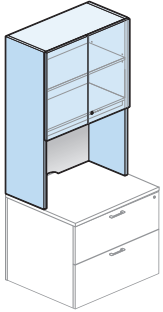

30" and 36" widths
X4VL-NW X5VL-NL
X4VD-NW X5VD-NL

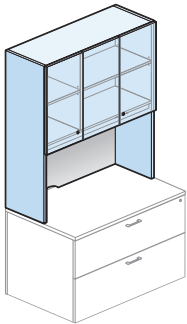

42"-54" widths
X4VL-LW X5VL-LL
X4VD-LW X5VD-LL

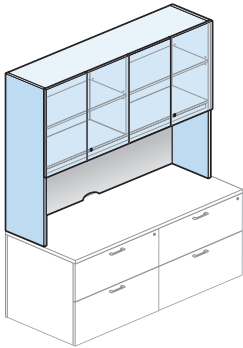

60"-72" widths
X4VL-NW X5VL-NL
X4VD-NW X5VD-NL

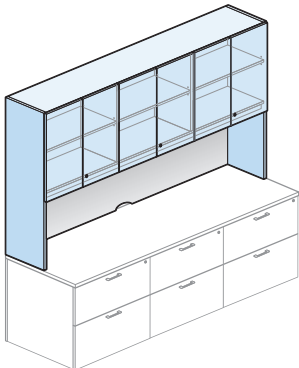

78"-96" widths
X4VL-NW X5VL-NL
X4VD-NW X5VD-NL
Class RA

Features

- Includes storage cabinet(s) with hinged doors, 2"(51mm) integrated light valance, one adjustable shelf, vertical supports and attachment material.
- 42"(1067mm), 48"(1219mm) and 54"(1372mm)W units available with choice of left or right door swing for single door.
- Optional locks available; each pair of doors and each single door lock separately.
- Lock plug is available in black or chrome.
- Common keys within each unit.
- For lock options, refer to Lock Program section of the Accessories Price List.
- 23.375"(594mm) clearance between top of worksurface and bottom of light valance.
- Standard unfinished two-piece back.
- The underside of the cabinet and front of lower section:
 - High-Pressure Laminate - the underside of the cabinet and front of lower section is finished.
 - Wood - the underside of the cabinet is finished, the lower section is unfinished.
- One interior .75"(19mm) thick wood shelf with ±1.25"(32mm) adjustment range.
- Unfinished clearcoat wireway scallop in bottom center of back panel.
- Shipped assembled.

Specification Tips

- Not for use on a freestanding or standalone desk.
- Designed to stack on equal width credenza, 2H storage cabinet or 2H lateral file. Refer to Stack-on Application Rules in Specification Guide.
- Accommodates separately specified tackboards and lighting accessories. Tackboard will block the ability to drop cords down or bring power to the surface. Use field installed grommets for power access.
- Aligns with 6H storage units.
- Wood units are not designed for applications where the back of unit is visible.

To Order, Specify:

1) Product number, including:

1 Lock Option:

- N** No Lock
- L** Lock
 - 30"-36" (add **\$177.50** list)
 - 42"-72" (add **\$355.01** list)
 - 78"-96" (add **\$532.52** list)

2 Single Door Swing Orientation:
(42", 48" and 54"W only)

- L** Left-hand
- R** Right-hand

- 2) Finish code (laminated or wood).
- 3) Laminate edge trim color (if laminate specified).
- 4) Trim color for lock (if specified).

Vertical Storage Unit

2H Hinged Doors

Nominal Height	Actual Height	Depth	Width	Number ① ②	HPL	
					A	B
HPL — Letter Depth						
52"(1321mm)	52.5"(1334mm)	14.8"(376mm)	30"(762mm)	X5VL-5230- SNL	\$2490.44	\$2623.48
		14.8"(376mm)	36"(914mm)	X5VL-5236- SNL	2662.03	2809.09
		14.8"(376mm)	42"(1067mm)	X5VL-5242- S L	2850.83	3011.91
		14.8"(376mm)	48"(1219mm)	X5VL-5248- S L	3022.42	3197.52
		14.8"(376mm)	54"(1372mm)	X5VL-5254- S L	3194.01	3383.13
		14.8"(376mm)	60"(1524mm)	X5VL-5260- SNL	3365.60	3568.74
		14.8"(376mm)	66"(1676mm)	X5VL-5266- SNL	3537.19	3754.35
		14.8"(376mm)	72"(1829mm)	X5VL-5272- SNL	3708.78	3939.96
		14.8"(376mm)	78"(1981mm)	X5VL-5278- SNL	3897.58	4142.78
		14.8"(376mm)	84"(2134mm)	X5VL-5284- SNL	4069.17	4328.39
		14.8"(376mm)	90"(2286mm)	X5VL-5290- SNL	4240.76	4514.00
		14.8"(376mm)	96"(2438mm)	X5VL-5296- SNL	4412.35	4699.61

HPL — Legal Depth						
52"(1321mm)	52.5"(1334mm)	17.3"(439mm)	30"(762mm)	X5VD-5230- SNL	\$2646.82	\$2792.36
		17.3"(439mm)	36"(914mm)	X5VD-5236- SNL	2818.41	2977.97
		17.3"(439mm)	42"(1067mm)	X5VD-5242- S L	3007.21	3180.79
		17.3"(439mm)	48"(1219mm)	X5VD-5248- S L	3178.80	3366.40
		17.3"(439mm)	54"(1372mm)	X5VD-5254- S L	3350.39	3552.01
		17.3"(439mm)	60"(1524mm)	X5VD-5260- SNL	3521.98	3737.62
		17.3"(439mm)	66"(1676mm)	X5VD-5266- SNL	3693.57	3923.23
		17.3"(439mm)	72"(1829mm)	X5VD-5272- SNL	3865.16	4108.84
		17.3"(439mm)	78"(1981mm)	X5VD-5278- SNL	4053.96	4311.66
		17.3"(439mm)	84"(2134mm)	X5VD-5284- SNL	4225.55	4497.27
		17.3"(439mm)	90"(2286mm)	X5VD-5290- SNL	4397.14	4682.88
		17.3"(439mm)	96"(2438mm)	X5VD-5296- SNL	4568.73	4868.49

Nominal Height	Actual Height	Depth	Width	Number ① ②	HPL	
					A	B
Wood — Letter Depth						
52"(1321mm)	52.5"(1334mm)	14.8"(376mm)	30"(762mm)	X4VL-5230- SNW	\$3628.21	\$3986.30
		14.8"(376mm)	36"(914mm)	X4VL-5236- SNW	3890.95	4274.82
		14.8"(376mm)	42"(1067mm)	X4VL-5242- S W	4170.90	4580.55
		14.8"(376mm)	48"(1219mm)	X4VL-5248- S W	4433.64	4869.07
		14.8"(376mm)	54"(1372mm)	X4VL-5254- S W	4696.38	5157.59
		14.8"(376mm)	60"(1524mm)	X4VL-5260- SNW	4959.12	5446.11
		14.8"(376mm)	66"(1676mm)	X4VL-5266- SNW	5221.86	5734.63
		14.8"(376mm)	72"(1829mm)	X4VL-5272- SNW	5484.60	6023.15
		14.8"(376mm)	78"(1981mm)	X4VL-5278- SNW	5764.55	6328.88
		14.8"(376mm)	84"(2134mm)	X4VL-5284- SNW	6027.29	6617.40
		14.8"(376mm)	90"(2286mm)	X4VL-5290- SNW	6290.03	6905.92
		14.8"(376mm)	96"(2438mm)	X4VL-5296- SNW	6552.77	7194.44

Wood — Legal Depth						
52"(1321mm)	52.5"(1334mm)	17.3"(439mm)	30"(762mm)	X4VD-5230- SNW	\$3839.34	\$4218.51
		17.3"(439mm)	36"(914mm)	X4VD-5236- SNW	4102.08	4507.03
		17.3"(439mm)	42"(1067mm)	X4VD-5242- S W	4382.03	4812.76
		17.3"(439mm)	48"(1219mm)	X4VD-5248- S W	4644.77	5101.28
		17.3"(439mm)	54"(1372mm)	X4VD-5254- S W	4907.51	5389.80
		17.3"(439mm)	60"(1524mm)	X4VD-5260- SNW	5170.25	5678.32
		17.3"(439mm)	66"(1676mm)	X4VD-5266- SNW	5432.99	5966.84
		17.3"(439mm)	72"(1829mm)	X4VD-5272- SNW	5695.73	6255.36
		17.3"(439mm)	78"(1981mm)	X4VD-5278- SNW	5975.68	6561.09
		17.3"(439mm)	84"(2134mm)	X4VD-5284- SNW	6238.42	6849.61
		17.3"(439mm)	90"(2286mm)	X4VD-5290- SNW	6501.16	7138.13
		17.3"(439mm)	96"(2438mm)	X4VD-5296- SNW	6763.90	7426.65

Vertical Storage Unit

1H Sliding Door

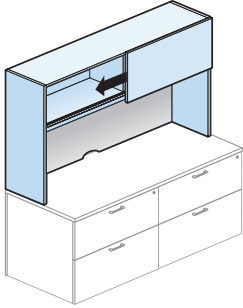

30"-72" widths

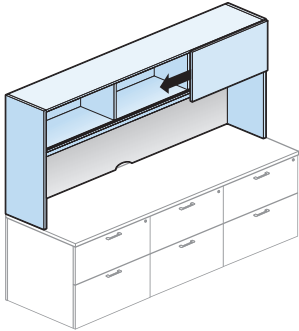

78"-90" widths
 X4RL-NW
 X4RD-NW
 X6RL-NL
 X6RD-NL
 Class RA

Features

- Includes storage cabinet(s) with one sliding door, 2"(51mm) integrated light valance, vertical supports and attachment material.
- Units 30"-72"(762mm-1829mm)W include two equal width sections divided by one inset intermediate center support.
- Units 78"-96"(1981mm-2438mm)W include three equal width sections divided by two inset intermediate center supports.
- Sliding door width is equal to one section width (one-half or one-third of unit width).
- Includes internally mounted sliding door track top and bottom with bumpers at each end.
- Locks not available.
- 23.375"(594mm) clearance between top of worksurface and bottom of light valance.
- Standard unfinished two-piece back.
- The underside of the cabinet and front of lower section:
 - High-Pressure Laminate - the underside of the cabinet and front of lower section is finished.
 - Wood - the underside of the cabinet is finished, the lower section is unfinished.
- Unfinished clearcoat wireway scallop in bottom center of back panel.
- Shipped assembled.

Specification Tips

- Not for use on a freestanding or standalone desk.
- Designed to stack on equal width credenza, 2H storage cabinet or 2H lateral file. Refer to Stack-on Application Rules in Specification Guide.
- Accommodates separately specified tackboards and lighting accessories. Tackboard will block the ability to drop cords down or bring power to the surface. Use field installed grommets for power access.
- Aligns with 5H storage units.
- Wood units are not designed for applications where the back of unit is visible.

To Order, Specify:

- 1) Product number.
- 2) Finish code (laminate or wood).
- 3) Laminate edge trim color (if laminate specified).

Vertical Storage Unit

1H Sliding Door

Nominal Height	Actual Height	Actual Depth	Width	Number	HPL A	B
HPL — Letter Depth						
40"(1016mm)	39.9"(1013mm)	14.8"(376mm)	30"(762mm)	X5RL-4030-NSNL	\$ 1849.24	\$ 1931.30
		14.8"(376mm)	36"(914mm)	X5RL-4036-NSNL	1971.61	2063.45
		14.8"(376mm)	42"(1067mm)	X5RL-4042-NSNL	2111.19	2212.81
		14.8"(376mm)	48"(1219mm)	X5RL-4048-NSNL	2233.56	2344.96
		14.8"(376mm)	54"(1372mm)	X5RL-4054-NSNL	2355.93	2477.11
		14.8"(376mm)	60"(1524mm)	X5RL-4060-NSNL	2478.30	2609.26
		14.8"(376mm)	66"(1676mm)	X5RL-4066-NSNL	2600.67	2741.41
		14.8"(376mm)	72"(1829mm)	X5RL-4072-NSNL	2723.04	2873.56
		14.8"(376mm)	78"(1981mm)	X5RL-4078-NSNL	2862.62	3022.92
		14.8"(376mm)	84"(2134mm)	X5RL-4084-NSNL	2984.99	3155.07
		14.8"(376mm)	90"(2286mm)	X5RL-4090-NSNL	3107.36	3287.22
		14.8"(376mm)	96"(2438mm)	X5RL-4096-NSNL	3229.73	3419.37

HPL — Legal Depth						
40"(1016mm)	39.9"(1013mm)	17.3"(439mm)	30"(762mm)	X5RD-4030-NSNL	\$2005.62	\$ 2100.18
		17.3"(439mm)	36"(914mm)	X5RD-4036-NSNL	2127.99	2232.33
		17.3"(439mm)	42"(1067mm)	X5RD-4042-NSNL	2267.57	2381.69
		17.3"(439mm)	48"(1219mm)	X5RD-4048-NSNL	2389.94	2513.84
		17.3"(439mm)	54"(1372mm)	X5RD-4054-NSNL	2512.31	2645.99
		17.3"(439mm)	60"(1524mm)	X5RD-4060-NSNL	2634.68	2778.14
		17.3"(439mm)	66"(1676mm)	X5RD-4066-NSNL	2757.05	2910.29
		17.3"(439mm)	72"(1829mm)	X5RD-4072-NSNL	2879.42	3042.44
		17.3"(439mm)	78"(1981mm)	X5RD-4078-NSNL	3019.00	3191.80
		17.3"(439mm)	84"(2134mm)	X5RD-4084-NSNL	3141.37	3323.95
		17.3"(439mm)	90"(2286mm)	X5RD-4090-NSNL	3263.74	3456.10
		17.3"(439mm)	96"(2438mm)	X5RD-4096-NSNL	3386.11	3588.25

Nominal Height	Actual Height	Actual Depth	Width	Number	Wood A	B
Wood — Letter Depth						
40"(1016mm)	39.9"(1013mm)	14.8"(376mm)	30"(762mm)	X4RL-4030-NSNW	\$ 2611.67	\$ 2872.81
		14.8"(376mm)	36"(914mm)	X4RL-4036-NSNW	2799.35	3079.23
		14.8"(376mm)	42"(1067mm)	X4RL-4042-NSNW	3004.24	3302.86
		14.8"(376mm)	48"(1219mm)	X4RL-4048-NSNW	3191.92	3509.28
		14.8"(376mm)	54"(1372mm)	X4RL-4054-NSNW	3379.60	3715.70
		14.8"(376mm)	60"(1524mm)	X4RL-4060-NSNW	3567.28	3922.12
		14.8"(376mm)	66"(1676mm)	X4RL-4066-NSNW	3754.96	4128.54
		14.8"(376mm)	72"(1829mm)	X4RL-4072-NSNW	3942.64	4334.96
		14.8"(376mm)	78"(1981mm)	X4RL-4078-NSNW	4147.53	4558.59
		14.8"(376mm)	84"(2134mm)	X4RL-4084-NSNW	4335.21	4765.01
		14.8"(376mm)	90"(2286mm)	X4RL-4090-NSNW	4522.89	4971.43
		14.8"(376mm)	96"(2438mm)	X4RL-4096-NSNW	4710.57	5177.85

Wood — Legal Depth						
40"(1016mm)	39.9"(1013mm)	17.3"(439mm)	30"(762mm)	X4RD-4030-NSNW	\$ 2822.80	\$ 3105.02
		17.3"(439mm)	36"(914mm)	X4RD-4036-NSNW	3010.48	3311.44
		17.3"(439mm)	42"(1067mm)	X4RD-4042-NSNW	3215.37	3535.07
		17.3"(439mm)	48"(1219mm)	X4RD-4048-NSNW	3403.05	3741.49
		17.3"(439mm)	54"(1372mm)	X4RD-4054-NSNW	3590.73	3947.91
		17.3"(439mm)	60"(1524mm)	X4RD-4060-NSNW	3778.41	4154.33
		17.3"(439mm)	66"(1676mm)	X4RD-4066-NSNW	3966.09	4360.75
		17.3"(439mm)	72"(1829mm)	X4RD-4072-NSNW	4153.77	4567.17
		17.3"(439mm)	78"(1981mm)	X4RD-4078-NSNW	4358.66	4790.80
		17.3"(439mm)	84"(2134mm)	X4RD-4084-NSNW	4546.34	4997.22
		90"(2286mm)	17.3"(439mm)	X4RD-4090-NSNW	4734.02	5203.64
		96"(2438mm)	17.3"(439mm)	X4RD-4096-NSNW	4921.70	5410.06

Vertical Storage Unit

2H Sliding Door

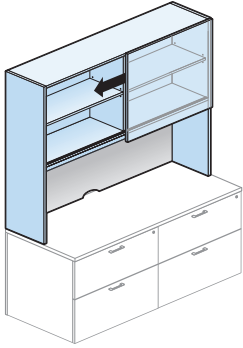

30"-72" widths

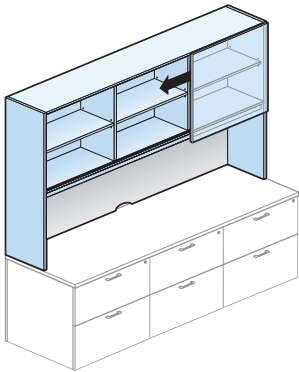

78"-90" widths
 X4RL-NW
 X4RD-NW
 X5RL-NL
 X5RD-NL
 Class RA

Features

- Includes storage cabinet(s) with one sliding door, 2"(51mm) integrated light valance, one adjustable shelf, vertical supports and attachment material.
- Units 30"-72"(762mm-1829mm)W include two equal width sections divided by one inset intermediate center support.
- Units 78"-96"(1981mm-2438mm)W include three equal width sections divided by two inset intermediate center supports.
- Sliding door width is equal to one section width (one-half or one-third of unit width).
- Includes internally mounted sliding door track top and bottom with bumpers at each end.
- Locks not available.
- 23.375"(594mm) clearance between top of worksurface and bottom of light valance.
- Standard unfinished two-piece back.
- The underside of the cabinet and front of lower section:
 - High-Pressure Laminate - the underside of the cabinet and front of lower section is finished.
 - Wood - the underside of the cabinet is finished, the lower section is unfinished.
- Unfinished clearcoat wireway scallop in bottom center of back panel.
- One interior .75"(19mm) thick wood shelf with ±1.25"(32mm) adjustment range.
- Shipped assembled.

Specification Tips

- Not for use on a freestanding or standalone desk.
- Designed to stack on equal width credenza, 2H storage cabinet or 2H lateral file. Refer to Stack-on Application Rules in Specification Guide.
- Accommodates separately specified tackboards and lighting accessories. Tackboard will block the ability to drop cords down or bring power to the surface. Use field installed grommets for power access.
- Aligns with 6H storage units.
- Wood units are not designed for applications where the back of unit is visible.

To Order, Specify:

- 1) Product number.
- 2) Finish code (laminate or wood).
- 3) Laminate edge trim color (if laminate specified).

Vertical Storage Unit

2H Sliding Door

Nominal Height	Actual Height	Actual Depth	Width	Number	HPL A	B
HPL — Letter Depth						
52"(1321mm)	52.5"(1334mm)	14.8"(376mm)	30"(762mm)	X5RL-5230-NSNL	\$ 2158.13	\$ 2264.55
		14.8"(376mm)	36"(914mm)	X5RL-5236-NSNL	2316.49	2435.79
		14.8"(376mm)	42"(1067mm)	X5RL-5242-NSNL	2492.06	2624.24
		14.8"(376mm)	48"(1219mm)	X5RL-5248-NSNL	2650.42	2795.48
		14.8"(376mm)	54"(1372mm)	X5RL-5254-NSNL	2808.78	2966.72
		14.8"(376mm)	60"(1524mm)	X5RL-5260-NSNL	2967.14	3137.96
		14.8"(376mm)	66"(1676mm)	X5RL-5266-NSNL	3125.50	3309.20
		14.8"(376mm)	72"(1829mm)	X5RL-5272-NSNL	3283.86	3480.44
		14.8"(376mm)	78"(1981mm)	X5RL-5278-NSNL	3459.43	3668.89
		14.8"(376mm)	84"(2134mm)	X5RL-5284-NSNL	3617.79	3840.13
		14.8"(376mm)	90"(2286mm)	X5RL-5290-NSNL	3776.15	4011.37
		14.8"(376mm)	96"(2438mm)	X5RL-5296-NSNL	3934.51	4182.61

HPL — Legal Depth						
52"(1321mm)	52.5"(1334mm)	17.3"(439mm)	30"(762mm)	X5RD-5230-NSNL	\$ 2314.51	\$ 2433.43
		17.3"(439mm)	36"(914mm)	X5RD-5236-NSNL	2472.87	2604.67
		17.3"(439mm)	42"(1067mm)	X5RD-5242-NSNL	2648.44	2793.12
		17.3"(439mm)	48"(1219mm)	X5RD-5248-NSNL	2806.80	2964.36
		17.3"(439mm)	54"(1372mm)	X5RD-5254-NSNL	2965.16	3135.60
		17.3"(439mm)	60"(1524mm)	X5RD-5260-NSNL	3123.52	3306.84
		17.3"(439mm)	66"(1676mm)	X5RD-5266-NSNL	3281.88	3478.08
		17.3"(439mm)	72"(1829mm)	X5RD-5272-NSNL	3440.24	3649.32
		17.3"(439mm)	78"(1981mm)	X5RD-5278-NSNL	3615.81	3837.77
		17.3"(439mm)	84"(2134mm)	X5RD-5284-NSNL	3774.17	4009.01
		17.3"(439mm)	90"(2286mm)	X5RD-5290-NSNL	3932.53	4180.25
		17.3"(439mm)	96"(2438mm)	X5RD-5296-NSNL	4090.89	4351.49

Nominal Height	Actual Height	Actual Depth	Width	Number	Wood A	B
Wood — Letter Depth						
52"(1321mm)	52.5"(1334mm)	14.8"(376mm)	30"(762mm)	X4RL-5230-NSNW	\$3080.85	\$ 3385.76
		14.8"(376mm)	36"(914mm)	X4RL-5236-NSNW	3323.26	3652.31
		14.8"(376mm)	42"(1067mm)	X4RL-5242-NSNW	3582.88	3936.07
		14.8"(376mm)	48"(1219mm)	X4RL-5248-NSNW	3825.29	4202.62
		14.8"(376mm)	54"(1372mm)	X4RL-5254-NSNW	4067.70	4469.17
		14.8"(376mm)	60"(1524mm)	X4RL-5260-NSNW	4310.11	4735.72
		14.8"(376mm)	66"(1676mm)	X4RL-5266-NSNW	4552.52	5002.27
		14.8"(376mm)	72"(1829mm)	X4RL-5272-NSNW	4794.93	5268.82
		14.8"(376mm)	78"(1981mm)	X4RL-5278-NSNW	5054.55	5552.58
		14.8"(376mm)	84"(2134mm)	X4RL-5284-NSNW	5296.96	5819.13
		14.8"(376mm)	90"(2286mm)	X4RL-5290-NSNW	5539.37	6085.68
		14.8"(376mm)	96"(2438mm)	X4RL-5296-NSNW	5781.78	6352.23

Wood — Legal Depth						
52"(1321mm)	52.5"(1334mm)	17.3"(439mm)	30"(762mm)	X4RD-5230-NSNW	\$ 3291.98	\$ 3617.97
		17.3"(439mm)	36"(914mm)	X4RD-5236-NSNW	3534.39	3884.52
		17.3"(439mm)	42"(1067mm)	X4RD-5242-NSNW	3794.01	4168.28
		17.3"(439mm)	48"(1219mm)	X4RD-5248-NSNW	4036.42	4434.83
		17.3"(439mm)	54"(1372mm)	X4RD-5254-NSNW	4278.83	4701.38
		17.3"(439mm)	60"(1524mm)	X4RD-5260-NSNW	4521.24	4967.93
		17.3"(439mm)	66"(1676mm)	X4RD-5266-NSNW	4763.65	5234.48
		17.3"(439mm)	72"(1829mm)	X4RD-5272-NSNW	5006.06	5501.03
		17.3"(439mm)	78"(1981mm)	X4RD-5278-NSNW	5265.68	5784.79
		17.3"(439mm)	84"(2134mm)	X4RD-5284-NSNW	5508.09	6051.34
		90"(2286mm)	17.3"(439mm)	X4RD-5290-NSNW	5750.50	6317.89
		96"(2438mm)	17.3"(439mm)	X4RD-5296-NSNW	5992.91	6584.44

Vertical Storage Unit

1H Glass Hinged Doors

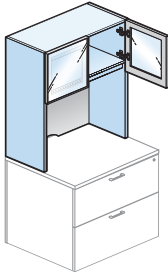

30" and 36" widths
X4SL-NT
X4SD-NT
X6SL-NT
X6SD-NT

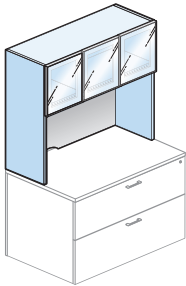

42"-54" widths
X4SL-LT
X4SD-LT
X6SL-LT
X6SD-LT

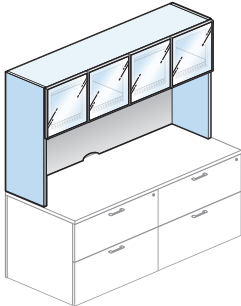

60"-72" widths
X4SL-NT
X4SD-NT
X6SL-NT
X6SD-NT

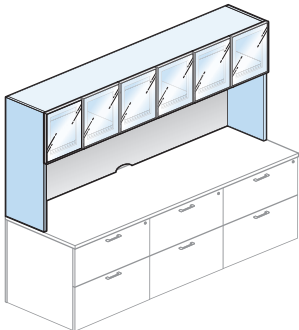

78"-96" widths
X4SL-NT
X4SD-NT
X6SL-NT
X6SD-NT
Class RA

Features

- Includes storage cabinet(s) with glass doors, 2"(51mm) integrated light valance, vertical supports and attachment material.
- 42"(1067mm), 48"(1219mm) and 54"(1372mm)W units available with choice of left or right door swing for single door.
- 23.375"(594mm) clearance between top of worksurface and bottom of light valance.
- Locks not available.
- Glass door includes metal frame with powdercoat finish on back side of door.
- The underside of the cabinet and front of lower section:
 - High-Pressure Laminate - the underside of the cabinet and front of lower section is finished.
 - Wood - the underside of the cabinet is finished, the lower section is unfinished.
- Standard unfinished two-piece back.
- Unfinished clearcoat wireway scallop in bottom center of back panel.
- Glass doors will be field installed.

Specification Tips

- Not for use on a freestanding or standalone desk.
- Designed to stack on equal width credenza, 2H storage cabinet or 2H lateral file. Refer to Stack-on Application Rules in Specification Guide.
- Accommodates separately specified tackboards and lighting accessories. Tackboard will block the ability to drop cords down or bring power to the surface. Use field installed grommets for power access.
- Aligns with 5H storage units.
- Wood units are not designed for applications where the back of unit is visible.

To Order, Specify:

- 1) Product number, including:
 - 1 **Single Door Swing Orientation:** (42", 48" and 54"W only)
 - L** Left-hand
 - R** Right-hand
- 2) Finish code (laminate or wood).
- 3) Laminate edge trim color (if laminate specified).
- 4) Glass code.
- 5) Trim color for glass frame.

Vertical Storage Unit

1H Glass Hinged Doors

Height	Depth	Width	Number	①	HPL A Glass				HPL B Glass			
					A	C	D	H	A	C	D	H
Letter Depth												
39.875"(1013mm)	14"(356mm)	30"(762mm)	X5SL-4030-NSNT		\$ 2493.75	\$ 2772.83	\$ 2959.05	\$ 3213.09	\$ 2556.30	\$ 2835.38	\$ 3021.60	\$ 3275.64
	14"(356mm)	36"(914mm)	X5SL-4036-NSNT		2655.22	2948.06	3143.42	3407.74	2727.14	3019.98	3215.34	3479.66
	14"(356mm)	42"(1067mm)	X5SL-4042-NS T		2833.90	3140.50	3345.00	3619.60	2915.19	3221.79	3426.29	3700.89
	14"(356mm)	48"(1219mm)	X5SL-4048-NS T		2995.37	3315.73	3529.37	3814.25	3086.03	3406.39	3620.03	3904.91
	14"(356mm)	54"(1372mm)	X5SL-4054-NS T		3156.84	3490.96	3713.74	4008.90	3256.87	3590.99	3813.77	4108.93
	14"(356mm)	60"(1524mm)	X5SL-4060-NSNT		3318.31	3666.19	3898.11	4203.55	3427.71	3775.59	4007.51	4312.95
	14"(356mm)	66"(1676mm)	X5SL-4066-NSNT		3479.78	3841.42	4082.48	4398.20	3598.55	3960.19	4201.25	4516.97
	14"(356mm)	72"(1829mm)	X5SL-4072-NSNT		3641.25	4016.65	4266.85	4592.85	3769.39	4144.79	4394.99	4720.99
	14"(356mm)	78"(1981mm)	X5SL-4078-NSNT		3819.93	4209.09	4468.43	4804.71	3957.44	4346.60	4605.94	4942.22
	14"(356mm)	84"(2134mm)	X5SL-4084-NSNT		3981.40	4384.32	4652.80	4999.36	4128.28	4531.20	4799.68	5146.24
	14"(356mm)	90"(2286mm)	X5SL-4090-NSNT		4142.87	4559.55	4837.17	5194.01	4299.12	4715.80	4993.42	5350.26
	14"(356mm)	96"(2438mm)	X5SL-4096-NSNT		4304.34	4734.78	5021.54	5388.66	4469.96	4900.40	5187.16	5554.28
Legal Depth												
39.875"(1013mm)	16.5"(419mm)	30"(762mm)	X5SD-4030-NSNT		\$ 2650.13	\$ 2929.21	\$ 3115.43	\$ 3369.47	\$ 2725.18	\$ 3004.26	\$ 3190.48	\$ 3444.52
	16.5"(419mm)	36"(914mm)	X5SD-4036-NSNT		2811.60	3104.44	3299.80	3564.12	2896.02	3188.86	3384.22	3648.54
	16.5"(419mm)	42"(1067mm)	X5SD-4042-NS T		2990.28	3296.88	3501.38	3775.98	3084.07	3390.67	3595.17	3869.77
	16.5"(419mm)	48"(1219mm)	X5SD-4048-NS T		3151.75	3472.11	3685.75	3970.63	3254.91	3575.27	3788.91	4073.79
	16.5"(419mm)	54"(1372mm)	X5SD-4054-NS T		3313.22	3647.34	3870.12	4165.28	3425.75	3759.87	3982.65	4277.81
	16.5"(419mm)	60"(1524mm)	X5SD-4060-NSNT		3474.69	3822.57	4054.49	4359.93	3596.59	3944.47	4176.39	4481.83
	16.5"(419mm)	66"(1676mm)	X5SD-4066-NSNT		3636.16	3997.80	4238.86	4554.58	3767.43	4129.07	4370.13	4685.85
	16.5"(419mm)	72"(1829mm)	X5SD-4072-NSNT		3797.63	4173.03	4423.23	4749.23	3938.27	4313.67	4563.87	4889.87
	16.5"(419mm)	78"(1981mm)	X5SD-4078-NSNT		3976.31	4365.47	4624.81	4961.09	4126.32	4515.48	4774.82	5111.10
	16.5"(419mm)	84"(2134mm)	X5SD-4084-NSNT		4137.78	4540.70	4809.18	5155.74	4297.16	4700.08	4968.56	5315.12
	16.5"(419mm)	90"(2286mm)	X5SD-4090-NSNT		4299.25	4715.93	4993.55	5350.39	4468.00	4884.68	5162.30	5519.14
	16.5"(419mm)	96"(2438mm)	X5SD-4096-NSNT		4460.72	4891.16	5177.92	5545.04	4638.84	5069.28	5356.04	5723.16

Height	Depth	Width	Number	①	Wood A Glass				Wood B Glass			
					A	C	D	H	A	C	D	H
Letter Depth												
39.875"(1013mm)	14"(356mm)	30"(762mm)	X4SL-4030-NSNT		\$ 3119.31	\$ 3398.39	\$ 3584.61	\$ 3838.65	\$ 3256.93	\$ 3536.01	\$ 3722.23	\$ 3976.27
	14"(356mm)	36"(914mm)	X4SL-4036-NSNT		3343.34	3636.18	3831.54	4095.86	3495.50	3788.34	3983.70	4248.02
	14"(356mm)	42"(1067mm)	X4SL-4042-NS T		3584.58	3891.18	4095.68	4370.28	3751.28	4057.88	4262.38	4536.98
	14"(356mm)	48"(1219mm)	X4SL-4048-NS T		3808.61	4128.97	4342.61	4627.49	3989.85	4310.21	4523.85	4808.73
	14"(356mm)	54"(1372mm)	X4SL-4054-NS T		4032.64	4366.76	4589.54	4884.70	4228.42	4562.54	4785.32	5080.48
	14"(356mm)	60"(1524mm)	X4SL-4060-NSNT		4256.67	4604.55	4836.47	5141.91	4466.99	4814.87	5046.79	5352.23
	14"(356mm)	66"(1676mm)	X4SL-4066-NSNT		4480.70	4842.34	5083.40	5399.12	4705.56	5067.20	5308.26	5623.98
	14"(356mm)	72"(1829mm)	X4SL-4072-NSNT		4704.73	5080.13	5330.33	5656.33	4944.13	5319.53	5569.73	5895.73
	14"(356mm)	78"(1981mm)	X4SL-4078-NSNT		4945.97	5335.13	5594.47	5930.75	5199.91	5589.07	5848.41	6184.69
	14"(356mm)	84"(2134mm)	X4SL-4084-NSNT		5170.00	5572.92	5841.40	6187.96	5438.48	5841.40	6109.88	6456.44
	14"(356mm)	90"(2286mm)	X4SL-4090-NSNT		5394.03	5810.71	6088.33	6445.17	5677.05	6093.73	6371.35	6728.19
	14"(356mm)	96"(2438mm)	X4SL-4096-NSNT		5618.06	6048.50	6335.26	6702.38	5915.62	6346.06	6632.82	6999.94
Legal Depth												
39.875"(1013mm)	16.5"(419mm)	30"(762mm)	X4SD-4030-NSNT		\$ 3330.44	\$ 3609.52	\$ 3795.74	\$ 4049.78	\$ 3489.14	\$ 3768.22	\$ 3954.44	\$ 4208.48
	16.5"(419mm)	36"(914mm)	X4SD-4036-NSNT		3554.47	3847.31	4042.67	4306.99	3727.71	4020.55	4215.91	4480.23
	16.5"(419mm)	42"(1067mm)	X4SD-4042-NS T		3795.71	4102.31	4306.81	4581.41	3983.49	4290.09	4494.59	4769.19
	16.5"(419mm)	48"(1219mm)	X4SD-4048-NS T		4019.74	4340.10	4553.74	4838.62	4222.06	4542.42	4756.06	5040.94
	16.5"(419mm)	54"(1372mm)	X4SD-4054-NS T		4243.77	4577.89	4800.67	5095.83	4460.63	4794.75	5017.53	5312.69
	16.5"(419mm)	60"(1524mm)	X4SD-4060-NSNT		4467.80	4815.68	5047.60	5353.04	4699.20	5047.08	5279.00	5584.44
	16.5"(419mm)	66"(1676mm)	X4SD-4066-NSNT		4691.83	5053.47	5294.53	5610.25	4937.77	5299.41	5540.47	5856.19
	16.5"(419mm)	72"(1829mm)	X4SD-4072-NSNT		4915.86	5291.26	5541.46	5867.46	5176.34	5551.74	5801.94	6127.94
	16.5"(419mm)	78"(1981mm)	X4SD-4078-NSNT		5157.10	5546.26	5805.60	6141.88	5432.12	5821.28	6080.62	6416.90
	16.5"(419mm)	84"(2134mm)	X4SD-4084-NSNT		5381.13	5784.05	6052.53	6399.09	5670.69	6073.61	6342.09	6688.65
	16.5"(419mm)	90"(2286mm)	X4SD-4090-NSNT		5605.16	6021.84	6299.46	6656.30	5909.26	6325.94	6603.56	6960.40
	16.5"(419mm)	96"(2438mm)	X4SD-4096-NSNT		5829.19	6259.63	6546.39	6913.51	6147.83	6578.27	6865.03	7232.15

Vertical Storage Unit

2H Glass Hinged Doors

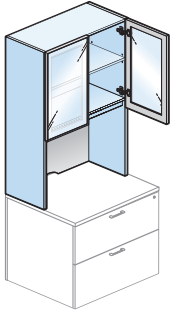

30" and 36" widths
X4SL-NT X5SL-NT
X4SD-NT X6SD-NT

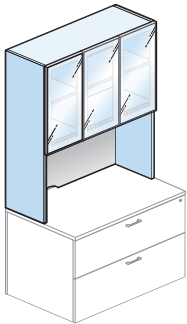

42"-54" widths
X4SL-LT X5SL-LT
X6SL-LT X6SD-LT

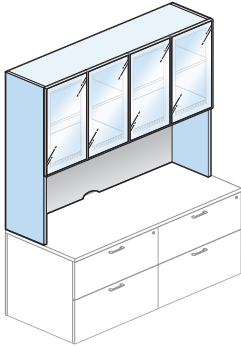

60"-72" widths
X4SL-NT X5SL-NT
X4SD-NT X6SD-NT

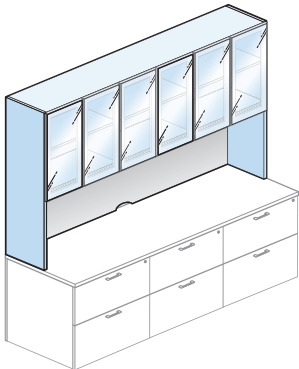

78"-96" widths
X4SL-NT X5SL-NT
X4SD-NT X6SD-NT

Class RA

Features

- Includes storage cabinet(s) with glass doors, 2"(51mm) integrated light valance, one adjustable shelf, vertical supports and attachment material.
- 42"(1067mm), 48"(1219mm) and 54"(1372mm)W units available with choice of left or right door swing for single door.
- 23.375"(594mm) clearance between top of worksurface and bottom of light valance.
- Locks not available.
- Glass door includes metal frame with powdercoat finish on back side of door.
- The underside of the cabinet and front of lower section:
 - High-Pressure Laminate - the underside of the cabinet and front of lower section is finished.
 - Wood - the underside of the cabinet is finished, the lower section is unfinished.
- Standard unfinished two-piece back.
- Unfinished clearcoat wireway scallop in bottom center of back panel.
- One interior .75"(19mm) thick wood shelf with ±1.25"(32mm) adjustment range.
- Glass doors will be field installed.

Specification Tips

- Not for use on a freestanding or standalone desk.
- Designed to stack on equal width credenza, 2H storage cabinet or 2H lateral file. Refer to Stack-on Application Rules in Specification Guide.
- Accommodates separately specified tackboards and lighting accessories. Tackboard will block the ability to drop cords down or bring power to the surface. Use field installed grommets for power access.
- Aligns with 6H storage units.
- Wood units are not designed for applications where the back of unit is visible.

To Order, Specify:

1) Product number, including:

1 Single Door Swing Orientation:
(42", 48" and 54"W only)

L Left-hand

R Right-hand

2) Finish code (laminate or wood).

3) Laminate edge trim color
(if laminate specified).

4) Glass code.

5) Trim color for glass frame.

Vertical Storage Unit

2H Glass Hinged Doors

Height	Depth	Width	Number	①	HPL A Glass				HPL B Glass			
					A	C	D	H	A	C	D	H
Letter Depth												
52.5"(1334mm)	14"(356mm)	30"(762mm)	X5SL-5230-NSNT		\$3338.84	\$3800.24	\$4108.09	\$4498.48	\$3421.71	\$3883.11	\$4190.96	\$4581.35
	14"(356mm)	36"(914mm)	X5SL-5236-NSNT		3536.30	4011.46	4328.45	4729.12	3631.64	4106.80	4423.79	4824.46
	14"(356mm)	42"(1067mm)	X5SL-5242-NS T		3750.97	4239.89	4566.02	4976.97	3858.78	4347.70	4673.83	5084.78
	14"(356mm)	48"(1219mm)	X5SL-5248-NS T		3948.43	4451.11	4786.38	5207.61	4068.71	4571.39	4906.66	5327.89
	14"(356mm)	54"(1372mm)	X5SL-5254-NS T		4145.89	4662.33	5006.74	5438.25	4278.64	4795.08	5139.49	5571.00
	14"(356mm)	60"(1524mm)	X5SL-5260-NSNT		4343.35	4873.55	5227.10	5668.89	4488.57	5018.77	5372.32	5814.11
	14"(356mm)	66"(1676mm)	X5SL-5266-NSNT		4540.81	5084.77	5447.46	5899.53	4698.50	5242.46	5605.15	6057.22
	14"(356mm)	72"(1829mm)	X5SL-5272-NSNT		4738.27	5295.99	5667.82	6130.17	4908.43	5466.15	5837.98	6300.33
	14"(356mm)	78"(1981mm)	X5SL-5278-NSNT		4952.94	5524.42	5905.39	6378.02	5135.57	5707.05	6088.02	6560.65
	14"(356mm)	84"(2134mm)	X5SL-5284-NSNT		5150.40	5735.64	6125.75	6608.66	5345.50	5930.74	6320.85	6803.76
	14"(356mm)	90"(2286mm)	X5SL-5290-NSNT		5347.86	5946.86	6346.11	6839.30	5555.43	6154.43	6553.68	7046.87
	14"(356mm)	96"(2438mm)	X5SL-5296-NSNT		5545.32	6158.08	6566.47	7069.94	5765.36	6378.12	6786.51	7289.98
Legal Depth												
52.5"(1334mm)	16.5"(419mm)	30"(762mm)	X5SD-5230-NSNT		\$3495.22	\$3956.62	\$4264.47	\$4654.86	\$3590.59	\$4051.99	\$4359.84	\$4750.23
	16.5"(419mm)	36"(914mm)	X5SD-5236-NSNT		3692.68	4167.84	4484.83	4885.50	3800.52	4275.68	4592.67	4993.34
	16.5"(419mm)	42"(1067mm)	X5SD-5242-NS T		3907.35	4396.27	4722.40	5133.35	4027.66	4516.58	4842.71	5253.66
	16.5"(419mm)	48"(1219mm)	X5SD-5248-NS T		4104.81	4607.49	4942.76	5363.99	4237.59	4740.27	5075.54	5496.77
	16.5"(419mm)	54"(1372mm)	X5SD-5254-NS T		4302.27	4818.71	5163.12	5594.63	4447.52	4963.96	5308.37	5739.88
	16.5"(419mm)	60"(1524mm)	X5SD-5260-NSNT		4499.73	5029.93	5383.48	5825.27	4657.45	5187.65	5541.20	5982.99
	16.5"(419mm)	66"(1676mm)	X5SD-5266-NSNT		4697.19	5241.15	5603.84	6055.91	4867.38	5411.34	5774.03	6226.10
	16.5"(419mm)	72"(1829mm)	X5SD-5272-NSNT		4894.65	5452.37	5824.20	6286.55	5077.31	5635.03	6006.86	6469.21
	16.5"(419mm)	78"(1981mm)	X5SD-5278-NSNT		5109.32	5680.80	6061.77	6534.40	5304.45	5875.93	6256.90	6729.53
	16.5"(419mm)	84"(2134mm)	X5SD-5284-NSNT		5306.78	5892.02	6282.13	6765.04	5514.38	6099.62	6489.73	6972.64
	16.5"(419mm)	90"(2286mm)	X5SD-5290-NSNT		5504.24	6103.24	6502.49	6995.68	5724.31	6323.31	6722.56	7215.75
	16.5"(419mm)	96"(2438mm)	X5SD-5296-NSNT		5701.70	6314.46	6722.85	7226.32	5934.24	6547.00	6955.39	7458.86
Wood A Glass												
Height	Depth	Width	Number	①	Wood A Glass				Wood B Glass			
					A	C	D	H	A	C	D	H
Letter Depth												
52.5"(1334mm)	14"(356mm)	30"(762mm)	X4SL-5230-NSNT		\$4097.33	\$4558.73	\$4866.58	\$5256.97	\$4274.03	\$4735.43	\$5043.28	\$5433.67
	14"(356mm)	36"(914mm)	X4SL-5236-NSNT		4376.09	4851.25	5168.24	5568.91	4572.73	5047.89	5364.88	5765.55
	14"(356mm)	42"(1067mm)	X4SL-5242-NS T		4672.06	5160.98	5487.11	5898.06	4888.64	5377.56	5703.69	6114.64
	14"(356mm)	48"(1219mm)	X4SL-5248-NS T		4950.82	5453.50	5788.77	6210.00	5187.34	5690.02	6025.29	6446.52
	14"(356mm)	54"(1372mm)	X4SL-5254-NS T		5229.58	5746.02	6090.43	6521.94	5486.04	6002.48	6346.89	6778.40
	14"(356mm)	60"(1524mm)	X4SL-5260-NSNT		5508.34	6038.54	6392.09	6833.88	5784.74	6314.94	6668.49	7110.28
	14"(356mm)	66"(1676mm)	X4SL-5266-NSNT		5787.10	6331.06	6693.75	7145.82	6083.44	6627.40	6990.09	7442.16
	14"(356mm)	72"(1829mm)	X4SL-5272-NSNT		6065.86	6623.58	6995.41	7457.76	6382.14	6939.86	7311.69	7774.04
	14"(356mm)	78"(1981mm)	X4SL-5278-NSNT		6361.83	6933.31	7314.28	7786.91	6698.05	7269.53	7650.50	8123.13
	14"(356mm)	84"(2134mm)	X4SL-5284-NSNT		6640.59	7225.83	7615.94	8098.85	6996.75	7581.99	7972.10	8455.01
	14"(356mm)	90"(2286mm)	X4SL-5290-NSNT		6919.35	7518.35	7917.60	8410.79	7295.45	7894.45	8293.70	8786.89
	14"(356mm)	96"(2438mm)	X4SL-5296-NSNT		7198.11	7810.87	8219.26	8722.73	7594.15	8206.91	8615.30	9118.77
Legal Depth												
52.5"(1334mm)	16.5"(419mm)	30"(762mm)	X4SD-5230-NSNT		\$4308.46	\$4769.86	\$5077.71	\$5468.10	\$4506.24	\$4967.64	\$5275.49	\$5665.88
	16.5"(419mm)	36"(914mm)	X4SD-5236-NSNT		4587.22	5062.38	5379.37	5780.04	4804.94	5280.10	5597.09	5997.76
	16.5"(419mm)	42"(1067mm)	X4SD-5242-NS T		4883.19	5372.11	5698.24	6109.19	5120.85	5609.77	5935.90	6346.85
	16.5"(419mm)	48"(1219mm)	X4SD-5248-NS T		5161.95	5664.63	5999.90	6421.13	5419.55	5922.23	6257.50	6678.73
	16.5"(419mm)	54"(1372mm)	X4SD-5254-NS T		5440.71	5957.15	6301.56	6733.07	5718.25	6234.69	6579.10	7010.61
	16.5"(419mm)	60"(1524mm)	X4SD-5260-NSNT		5719.47	6249.67	6603.22	7045.01	6016.95	6547.15	6900.70	7342.49
	16.5"(419mm)	66"(1676mm)	X4SD-5266-NSNT		5998.23	6542.19	6904.88	7356.95	6315.65	6859.61	7222.30	7674.37
	16.5"(419mm)	72"(1829mm)	X4SD-5272-NSNT		6276.99	6834.71	7206.54	7668.89	6614.35	7172.07	7543.90	8006.25
	16.5"(419mm)	78"(1981mm)	X4SD-5278-NSNT		6572.96	7144.44	7525.41	7998.04	6930.26	7501.74	7882.71	8355.34
	16.5"(419mm)	84"(2134mm)	X4SD-5284-NSNT		6851.72	7436.96	7827.07	8309.98	7228.96	7814.20	8204.31	8687.22
	16.5"(419mm)	90"(2286mm)	X4SD-5290-NSNT		7130.48	7729.48	8128.73	8621.92	7527.66	8126.66	8525.91	9019.10
	16.5"(419mm)	96"(2438mm)	X4SD-5296-NSNT		7409.24	8022.00	8430.39	8933.86	7826.36	8439.12	8847.51	9350.98

Vertical Storage Unit

1H Glass Sliding Door

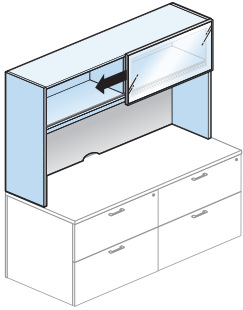

30"-72" widths

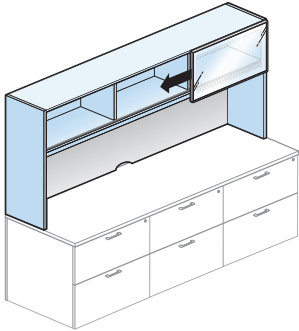

78"-90" widths
 X4LL-NT
 X4LD-NT
 X6LL-NT
 X6LD-NT
 Class RA

Features

- Includes storage cabinet(s) with one glass sliding door, 2"(51mm) integrated light valance, vertical supports and attachment material.
- Units 30"-72"(762mm-1829mm)W include two equal width sections divided by one inset intermediate center support.
- Units 78"-96"(1981mm-2438mm)W include three equal width sections divided by two inset intermediate center supports.
- Locks not available.
- Glass door includes metal frame with powdercoat finish on back side of door.
- Includes internally mounted sliding door track top and bottom with bumpers at each end.
- 23.375"(594mm) clearance between top of worksurface and bottom of light valance.
- The underside of the cabinet and front of lower section:
 - High-Pressure Laminate - the underside of the cabinet and front of lower section is finished.
 - Wood - the underside of the cabinet is finished, the lower section is unfinished.
- Standard unfinished two-piece back.
- Unfinished clearcoat wireway scallop in bottom center of back panel.
- Glass doors will be field installed.

Specification Tips

- Not for use on a freestanding or standalone desk.
- Designed to stack on equal width credenza, 2H storage cabinet or 2H lateral file. Refer to Stack-on Application Rules in Specification Guide.
- Accommodates separately specified tackboards and lighting accessories. Tackboard will block the ability to drop cords down or bring power to the surface. Use field installed grommets for power access.
- Aligns with 5H storage units.
- Only back-painted glass available as standard; specifying alternate glass may allow for the light valance and hardware to be visible.
- Wood units are not designed for applications where the back of unit is visible.

To Order, Specify:

- 1) Product number.
- 2) Finish code (laminate or wood).
- 3) Laminate edge trim color (if laminate specified).
- 4) Glass code.
- 5) Trim color for glass frame.

Vertical Storage Unit

1H Glass Sliding Door

Height	Depth	Width	Number	①	HPL A Glass				HPL B Glass			
					A	C	D	H	A	C	D	H
Letter Depth												
39.875"(1013mm)	14"(356mm)	30"(762mm)	X5LL-4030-NSNT		\$ 2248.67	\$ 2451.65	\$ 2587.03	\$ 2738.81	\$ 2311.22	\$ 2514.20	\$ 2649.58	\$ 2801.36
	14"(356mm)	36"(914mm)	X5LL-4036-NSNT		2404.84	2619.90	2763.34	2926.09	2476.76	2691.82	2835.26	2998.01
	14"(356mm)	42"(1067mm)	X5LL-4042-NSNT		2578.22	2805.36	2956.86	3130.58	2659.51	2886.65	3038.15	3211.87
	14"(356mm)	48"(1219mm)	X5LL-4048-NSNT		2734.39	2973.61	3133.17	3317.86	2825.05	3064.27	3223.83	3408.52
	14"(356mm)	54"(1372mm)	X5LL-4054-NSNT		2890.56	3141.86	3309.48	3505.14	2990.59	3241.89	3409.51	3605.17
	14"(356mm)	60"(1524mm)	X5LL-4060-NSNT		3046.73	3310.11	3485.79	3692.42	3156.13	3419.51	3595.19	3801.82
	14"(356mm)	66"(1676mm)	X5LL-4066-NSNT		3202.90	3478.36	3662.10	3879.70	3321.67	3597.13	3780.87	3998.47
	14"(356mm)	72"(1829mm)	X5LL-4072-NSNT		3359.07	3646.61	3838.41	4066.98	3487.21	3774.75	3966.55	4195.12
	14"(356mm)	78"(1981mm)	X5LL-4078-NSNT		3532.45	3832.07	4031.93	4271.47	3669.96	3969.58	4169.44	4408.98
	14"(356mm)	84"(2134mm)	X5LL-4084-NSNT		3688.62	4000.32	4208.24	4458.75	3835.50	4147.20	4355.12	4605.63
	14"(356mm)	90"(2286mm)	X5LL-4090-NSNT		3844.79	4168.57	4384.55	4646.03	4001.04	4324.82	4540.80	4802.28
	14"(356mm)	96"(2438mm)	X5LL-4096-NSNT		4000.96	4336.82	4560.86	4833.31	4166.58	4502.44	4726.48	4998.93
Legal Depth												
39.875"(1013mm)	16.5"(419mm)	30"(762mm)	X5LD-4030-NSNT		\$ 2405.05	\$ 2608.03	\$ 2743.41	\$ 2895.19	\$ 2480.10	\$ 2683.08	\$ 2818.46	\$ 2970.24
	16.5"(419mm)	36"(914mm)	X5LD-4036-NSNT		2561.22	2776.28	2919.72	3082.47	2645.64	2860.70	3004.14	3166.89
	16.5"(419mm)	42"(1067mm)	X5LD-4042-NSNT		2734.60	2961.74	3113.24	3286.96	2828.39	3055.53	3207.03	3380.75
	16.5"(419mm)	48"(1219mm)	X5LD-4048-NSNT		2890.77	3129.99	3289.55	3474.24	2993.93	3233.15	3392.71	3577.40
	16.5"(419mm)	54"(1372mm)	X5LD-4054-NSNT		3046.94	3298.24	3465.86	3661.52	3159.47	3410.77	3578.39	3774.05
	16.5"(419mm)	60"(1524mm)	X5LD-4060-NSNT		3203.11	3466.49	3642.17	3848.80	3325.01	3588.39	3764.07	3970.70
	16.5"(419mm)	66"(1676mm)	X5LD-4066-NSNT		3359.28	3634.74	3818.48	4036.08	3490.55	3766.01	3949.75	4167.35
	16.5"(419mm)	72"(1829mm)	X5LD-4072-NSNT		3515.45	3802.99	3994.79	4223.36	3656.09	3943.63	4135.43	4364.00
	16.5"(419mm)	78"(1981mm)	X5LD-4078-NSNT		3688.83	3988.45	4188.31	4427.85	3838.84	4138.46	4338.32	4577.86
	16.5"(419mm)	84"(2134mm)	X5LD-4084-NSNT		3845.00	4156.70	4364.62	4615.13	4004.38	4316.08	4524.00	4774.51
	16.5"(419mm)	90"(2286mm)	X5LD-4090-NSNT		4001.17	4324.95	4540.93	4802.41	4169.92	4493.70	4709.68	4971.16
	16.5"(419mm)	96"(2438mm)	X5LD-4096-NSNT		4157.34	4493.20	4717.24	4989.69	4335.46	4671.32	4895.36	5167.81

Height	Depth	Width	Number	①	Wood A Glass				Wood B Glass			
					A	C	D	H	A	C	D	H
Letter Depth												
39.875"(1013mm)	14"(356mm)	30"(762mm)	X4LL-4030-NSNT		\$ 2874.23	\$ 3077.21	\$ 3212.59	\$ 3364.37	\$ 3011.85	\$ 3214.83	\$ 3350.21	\$ 3501.99
	14"(356mm)	36"(914mm)	X4LL-4036-NSNT		3092.96	3308.02	3451.46	3614.21	3245.12	3460.18	3603.62	3766.37
	14"(356mm)	42"(1067mm)	X4LL-4042-NSNT		3328.90	3556.04	3707.54	3881.26	3495.60	3722.74	3874.24	4047.96
	14"(356mm)	48"(1219mm)	X4LL-4048-NSNT		3547.63	3786.85	3946.41	4131.10	3728.87	3968.09	4127.65	4312.34
	14"(356mm)	54"(1372mm)	X4LL-4054-NSNT		3766.36	4017.66	4185.28	4380.94	3962.14	4213.44	4381.06	4576.72
	14"(356mm)	60"(1524mm)	X4LL-4060-NSNT		3985.09	4248.47	4424.15	4630.78	4195.41	4458.79	4634.47	4841.10
	14"(356mm)	66"(1676mm)	X4LL-4066-NSNT		4203.82	4479.28	4663.02	4880.62	4428.68	4704.14	4887.88	5105.48
	14"(356mm)	72"(1829mm)	X4LL-4072-NSNT		4422.55	4710.09	4901.89	5130.46	4661.95	4949.49	5141.29	5369.86
	14"(356mm)	78"(1981mm)	X4LL-4078-NSNT		4658.49	4958.11	5157.97	5397.51	4912.43	5212.05	5411.91	5651.45
	14"(356mm)	84"(2134mm)	X4LL-4084-NSNT		4877.22	5188.92	5396.84	5647.35	5145.70	5457.40	5665.32	5915.83
	14"(356mm)	90"(2286mm)	X4LL-4090-NSNT		5095.95	5419.73	5635.71	5897.19	5378.97	5702.75	5918.73	6180.21
	14"(356mm)	96"(2438mm)	X4LL-4096-NSNT		5314.68	5650.54	5874.58	6147.03	5612.24	5948.10	6172.14	6444.59
Legal Depth												
39.875"(1013mm)	16.5"(419mm)	30"(762mm)	X4LD-4030-NSNT		\$ 3085.36	\$ 3288.34	\$ 3423.72	\$ 3575.50	\$ 3244.06	\$ 3447.04	\$ 3582.42	\$ 3734.20
	16.5"(419mm)	36"(914mm)	X4LD-4036-NSNT		3304.09	3519.15	3662.59	3825.34	3477.33	3692.39	3835.83	3998.58
	16.5"(419mm)	42"(1067mm)	X4LD-4042-NSNT		3540.03	3767.17	3918.67	4092.39	3727.81	3954.95	4106.45	4280.17
	16.5"(419mm)	48"(1219mm)	X4LD-4048-NSNT		3758.76	3997.98	4157.54	4342.23	3961.08	4200.30	4359.86	4544.55
	16.5"(419mm)	54"(1372mm)	X4LD-4054-NSNT		3977.49	4228.79	4396.41	4592.07	4194.35	4445.65	4613.27	4808.93
	16.5"(419mm)	60"(1524mm)	X4LD-4060-NSNT		4196.22	4459.60	4635.28	4841.91	4427.62	4691.00	4866.68	5073.31
	16.5"(419mm)	66"(1676mm)	X4LD-4066-NSNT		4414.95	4690.41	4874.15	5091.75	4660.89	4936.35	5120.09	5337.69
	16.5"(419mm)	72"(1829mm)	X4LD-4072-NSNT		4633.68	4921.22	5113.02	5341.59	4894.16	5181.70	5373.50	5602.07
	16.5"(419mm)	78"(1981mm)	X4LD-4078-NSNT		4869.62	5169.24	5369.10	5608.64	5144.64	5444.26	5644.12	5883.66
	16.5"(419mm)	84"(2134mm)	X4LD-4084-NSNT		5088.35	5400.05	5607.97	5858.48	5377.91	5689.61	5897.53	6148.04
	16.5"(419mm)	90"(2286mm)	X4LD-4090-NSNT		5307.08	5630.86	5846.84	6108.32	5611.18	5934.96	6150.94	6412.42
	16.5"(419mm)	96"(2438mm)	X4LD-4096-NSNT		5525.81	5861.67	6085.71	6358.16	5844.45	6180.31	6404.35	6676.80

Vertical Storage Unit

2H Glass Sliding Door

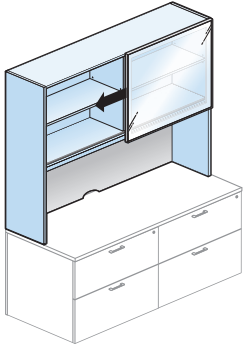

30"-72" widths

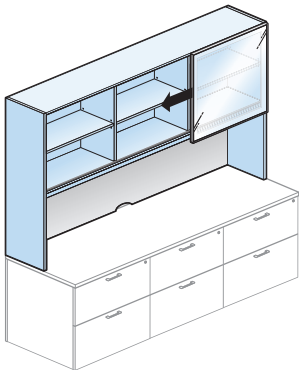

78"-90" widths
X4LL-NT
X4LD-NT
X6LL-NT
X6LD-NT
Class RA

Features

- Includes storage cabinet(s) with one glass sliding door, 2"(51mm) integrated light valance, one adjustable shelf, vertical supports and attachment material.
- Unfinished clearcoat wireway scallop in bottom center of back panel.
- Units 30"-72"(762mm-1829mm)W include two equal width sections divided by one inset intermediate center support.
- Units 78"-96"(1981mm-2438mm)W include three equal width sections divided by two inset intermediate center supports.
- Sliding door width is equal to one section width (one-half or one-third of unit width).
- Locks not available.
- Glass door includes metal frame with powdercoat finish on back side of door.
- Includes internally mounted sliding door track top and bottom with bumpers at each end.
- 23.375"(594mm) clearance between top of worksurface and bottom of light valance.
- The underside of the cabinet and front of lower section:
 - High-Pressure Laminate - the underside of the cabinet and front of lower section is finished.
 - Wood - the underside of the cabinet is finished, the lower section is unfinished.
- Standard unfinished two-piece back.
- One interior .75"(19mm) thick wood shelf with ±1.25"(32mm) adjustment range.
- Glass doors will be field installed.

Specification Tips

- Not for use on a freestanding or standalone desk.
- Designed to stack on equal width credenza, 2H storage cabinet or 2H lateral file. Refer to Stack-on Application Rules in Specification Guide.
- Accommodates separately specified tackboards and lighting accessories. Tackboard will block the ability to drop cords down or bring power to the surface. Use field installed grommets for power access.
- Aligns with 6H storage units.
- Only back-painted glass available as standard; specifying alternate glass may allow for the light valance and hardware to be visible.
- Wood units are not designed for applications where the back of unit is visible.

To Order, Specify:

- 1) Product number.
- 2) Finish code (laminate or wood).
- 3) Laminate edge trim color (if laminate specified).
- 4) Glass code.
- 5) Trim color for glass frame.

Vertical Storage Unit

2H Glass Sliding Door

Height	Depth	Width	Number	①	HPL A Glass				HPL B Glass			
					A	C	D	H	A	C	D	H
Letter Depth												
52.5"(1334mm)	14"(356mm)	30"(762mm)	X5LL-5230-NSNT		\$ 2891.95	\$ 3214.57	\$ 3429.81	\$ 3690.32	\$ 2974.82	\$ 3297.44	\$ 3512.68	\$ 3773.19
	14"(356mm)	36"(914mm)	X5LL-5236-NSNT		3084.11	3418.81	3642.11	3913.59	3179.45	3514.15	3737.45	4008.93
	14"(356mm)	42"(1067mm)	X5LL-5242-NSNT		3293.48	3640.26	3871.62	4154.07	3401.29	3748.07	3979.43	4261.88
	14"(356mm)	48"(1219mm)	X5LL-5248-NSNT		3485.64	3844.50	4083.92	4377.34	3605.92	3964.78	4204.20	4497.62
	14"(356mm)	54"(1372mm)	X5LL-5254-NSNT		3677.80	4048.74	4296.22	4600.61	3810.55	4181.49	4428.97	4733.36
	14"(356mm)	60"(1524mm)	X5LL-5260-NSNT		3869.96	4252.98	4508.52	4823.88	4015.18	4398.20	4653.74	4969.10
	14"(356mm)	66"(1676mm)	X5LL-5266-NSNT		4062.12	4457.22	4720.82	5047.15	4219.81	4614.91	4878.51	5204.84
	14"(356mm)	72"(1829mm)	X5LL-5272-NSNT		4254.28	4661.46	4933.12	5270.42	4424.44	4831.62	5103.28	5440.58
	14"(356mm)	78"(1981mm)	X5LL-5278-NSNT		4463.65	4882.91	5162.63	5510.90	4646.28	5065.54	5345.26	5693.53
	14"(356mm)	84"(2134mm)	X5LL-5284-NSNT		4655.81	5087.15	5374.93	5734.17	4850.91	5282.25	5570.03	5929.27
	14"(356mm)	90"(2286mm)	X5LL-5290-NSNT		4847.97	5291.39	5587.23	5957.44	5055.54	5498.96	5794.80	6165.01
	14"(356mm)	96"(2438mm)	X5LL-5296-NSNT		5040.13	5495.63	5799.53	6180.71	5260.17	5715.67	6019.57	6400.75
Legal Depth												
52.5"(1334mm)	16.5"(419mm)	30"(762mm)	X5LD-5230-NSNT		\$ 3048.33	\$ 3370.95	\$ 3586.19	\$ 3846.70	\$ 3143.70	\$ 3466.32	\$ 3681.56	\$ 3942.07
	16.5"(419mm)	36"(914mm)	X5LD-5236-NSNT		3240.49	3575.19	3798.49	4069.97	3348.33	3683.03	3906.33	4177.81
	16.5"(419mm)	42"(1067mm)	X5LD-5242-NSNT		3449.86	3796.64	4028.00	4310.45	3570.17	3916.95	4148.31	4430.76
	16.5"(419mm)	48"(1219mm)	X5LD-5248-NSNT		3642.02	4000.88	4240.30	4533.72	3774.80	4133.66	4373.08	4666.50
	16.5"(419mm)	54"(1372mm)	X5LD-5254-NSNT		3834.18	4205.12	4452.60	4756.99	3979.43	4350.37	4597.85	4902.24
	16.5"(419mm)	60"(1524mm)	X5LD-5260-NSNT		4026.34	4409.36	4664.90	4980.26	4184.06	4567.08	4822.62	5137.98
	16.5"(419mm)	66"(1676mm)	X5LD-5266-NSNT		4218.50	4613.60	4877.20	5203.53	4388.69	4783.79	5047.39	5373.72
	16.5"(419mm)	72"(1829mm)	X5LD-5272-NSNT		4410.66	4817.84	5089.50	5426.80	4593.32	5000.50	5272.16	5609.46
	16.5"(419mm)	78"(1981mm)	X5LD-5278-NSNT		4620.03	5039.29	5319.01	5667.28	4815.16	5234.42	5514.14	5862.41
	16.5"(419mm)	84"(2134mm)	X5LD-5284-NSNT		4812.19	5243.53	5531.31	5890.55	5019.79	5451.13	5738.91	6098.15
	16.5"(419mm)	90"(2286mm)	X5LD-5290-NSNT		5004.35	5447.77	5743.61	6113.82	5224.42	5667.84	5963.68	6333.89
	16.5"(419mm)	96"(2438mm)	X5LD-5296-NSNT		5196.51	5652.01	5955.91	6337.09	5429.05	5884.55	6188.45	6569.63
Height	Depth	Width	Number	①	Wood A Glass				Wood B Glass			
					A	C	D	H	A	C	D	H
Letter Depth												
52.5"(1334mm)	14"(356mm)	30"(762mm)	X4LL-5230-NSNT		\$ 3650.44	\$ 3973.06	\$ 4188.30	\$ 4448.81	\$ 3827.14	\$ 4149.76	\$ 4365.00	\$ 4625.51
	14"(356mm)	36"(914mm)	X4LL-5236-NSNT		3923.90	4258.60	4481.90	4753.38	4120.54	4455.24	4678.54	4950.02
	14"(356mm)	42"(1067mm)	X4LL-5242-NSNT		4214.57	4561.35	4792.71	5075.16	4431.15	4777.93	5009.29	5291.74
	14"(356mm)	48"(1219mm)	X4LL-5248-NSNT		4488.03	4846.89	5086.31	5379.73	4724.55	5083.41	5322.83	5616.25
	14"(356mm)	54"(1372mm)	X4LL-5254-NSNT		4761.49	5132.43	5379.91	5684.30	5017.95	5388.89	5636.37	5940.76
	14"(356mm)	60"(1524mm)	X4LL-5260-NSNT		5034.95	5417.97	5673.51	5988.87	5311.35	5694.37	5949.91	6265.27
	14"(356mm)	66"(1676mm)	X4LL-5266-NSNT		5308.41	5703.51	5967.11	6293.44	5604.75	5999.85	6263.45	6589.78
	14"(356mm)	72"(1829mm)	X4LL-5272-NSNT		5581.87	5989.05	6260.71	6598.01	5898.15	6305.33	6576.99	6914.29
	14"(356mm)	78"(1981mm)	X4LL-5278-NSNT		5872.54	6291.80	6571.52	6919.79	6208.76	6628.02	6907.74	7256.01
	14"(356mm)	84"(2134mm)	X4LL-5284-NSNT		6146.00	6577.34	6865.12	7224.36	6502.16	6933.50	7221.28	7580.52
	14"(356mm)	90"(2286mm)	X4LL-5290-NSNT		6419.46	6862.88	7158.72	7528.93	6795.56	7238.98	7534.82	7905.03
	14"(356mm)	96"(2438mm)	X4LL-5296-NSNT		6692.92	7148.42	7452.32	7833.50	7088.96	7544.46	7848.36	8229.54
Legal Depth												
52.5"(1334mm)	16.5"(419mm)	30"(762mm)	X4LD-5230-NSNT		\$ 3861.57	\$ 4184.19	\$ 4399.43	\$ 4659.94	\$ 4059.35	\$ 4381.97	\$ 4597.21	\$ 4857.72
	16.5"(419mm)	36"(914mm)	X4LD-5236-NSNT		4135.03	4469.73	4693.03	4964.51	4352.75	4687.45	4910.75	5182.23
	16.5"(419mm)	42"(1067mm)	X4LD-5242-NSNT		4425.70	4772.48	5003.84	5286.29	4663.36	5010.14	5241.50	5523.95
	16.5"(419mm)	48"(1219mm)	X4LD-5248-NSNT		4699.16	5058.02	5297.44	5590.86	4956.76	5315.62	5555.04	5848.46
	16.5"(419mm)	54"(1372mm)	X4LD-5254-NSNT		4972.62	5343.56	5591.04	5895.43	5250.16	5621.10	5868.58	6172.97
	16.5"(419mm)	60"(1524mm)	X4LD-5260-NSNT		5246.08	5629.10	5884.64	6200.00	5543.56	5926.58	6182.12	6497.48
	16.5"(419mm)	66"(1676mm)	X4LD-5266-NSNT		5519.54	5914.64	6178.24	6504.57	5836.96	6232.06	6495.66	6821.99
	16.5"(419mm)	72"(1829mm)	X4LD-5272-NSNT		5793.00	6200.18	6471.84	6809.14	6130.36	6537.54	6809.20	7146.50
	16.5"(419mm)	78"(1981mm)	X4LD-5278-NSNT		6083.67	6502.93	6782.65	7130.92	6440.97	6860.23	7139.95	7488.22
	16.5"(419mm)	84"(2134mm)	X4LD-5284-NSNT		6357.13	6788.47	7076.25	7435.49	6734.37	7165.71	7453.49	7812.73
	16.5"(419mm)	90"(2286mm)	X4LD-5290-NSNT		6630.59	7074.01	7369.85	7740.06	7027.77	7471.19	7767.03	8137.24
	16.5"(419mm)	96"(2438mm)	X4LD-5296-NSNT		6904.05	7359.55	7663.45	8044.63	7321.17	7776.67	8080.57	8461.75

Vertical Storage Unit Tackboard

Fabric

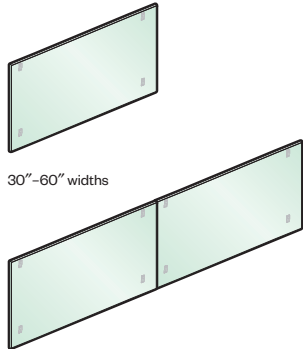

30"-60" widths

66"-96" widths

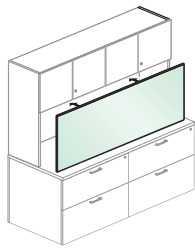

MTVD
Class RA

Features

- Tackboards over 60"(1524mm)W include two fabric sections.

Specification Tips

- Designed to mount on lower back panel of vertical storage unit.
- Tackboard widths are nominal; Catalog Number indicates width of Vertical Storage Unit for which the tackboard is to be used.

To Order, Specify:

- 1) Product number.
- 2) Fabric code.

Height	Width	Number	Fabric		
			A	B	C
24"(610mm)	27.5"(699mm)	MTVD-2430	\$390.67	\$ 436.56	\$ 488.36
	33.5"(851mm)	MTVD-2436	417.16	467.04	523.30
	39.5"(1003mm)	MTVD-2442	443.65	497.52	558.24
	45.5"(1156mm)	MTVD-2448	470.14	528.00	593.18
	51.5"(1308mm)	MTVD-2454	496.63	558.48	628.12
	57.5"(1461mm)	MTVD-2460	523.12	588.96	663.06
	63.5"(1613mm)	MTVD-2466	668.67	769.04	882.46
	69.5"(1765mm)	MTVD-2472	729.20	838.65	962.34
	75.5"(1918mm)	MTVD-2478	789.73	908.26	1042.22
	81.5"(2070mm)	MTVD-2484	850.26	977.87	1122.10
	87.5"(2223mm)	MTVD-2490	910.79	1047.48	1201.98
	93.5"(2375mm)	MTVD-2496	971.32	1117.09	1281.86

Fabric and Slat Rail

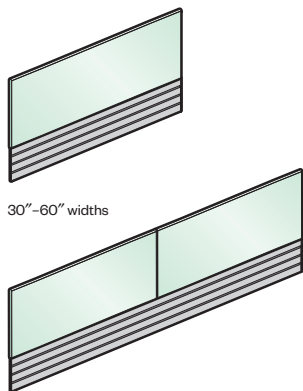

30"-60" widths

66"-96" widths

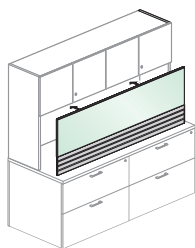

MTSV
Class RA

Features

- Includes fabric covered tackboard(s) with slat rail. Tackboards over 60"(1524mm)W include two fabric sections.
- Optional slat rail is one full-width section.

Specification Tips

- Designed to mount on lower back panel of vertical storage unit.
- Slat rail accommodates separately specified Belong work tools.
- Tackboard widths are nominal; Catalog Number indicates width of Vertical Storage Unit for which the tackboard is to be used.

To Order, Specify:

- 1) Product number.
- 2) Fabric code.
- 3) Trim code for slat rail.

Height	Width	Number	Fabric		
			A	B	C
24"(610mm)	27.5"(699mm)	MTSV-2430	\$ 624.11	\$ 643.63	\$ 656.61
	33.5"(851mm)	MTSV-2436	664.82	685.43	699.32
	39.5"(1003mm)	MTSV-2442	705.53	727.23	742.03
	45.5"(1156mm)	MTSV-2448	746.24	769.03	784.74
	51.5"(1308mm)	MTSV-2454	786.95	810.83	827.45
	51.5"(1308mm)	MTSV-2460	827.66	852.63	870.16
	63.5"(1613mm)	MTSV-2466	948.21	979.70	1003.39
	69.5"(1765mm)	MTSV-2472	1025.95	1060.01	1085.52
	75.5"(1918mm)	MTSV-2478	1103.69	1140.32	1167.65
	81.5"(2070mm)	MTSV-2484	1181.43	1220.63	1249.78
	87.5"(2223mm)	MTSV-2490	1259.17	1300.94	1331.91
	93.5"(2375mm)	MTSV-2496	1324.84	1390.55	1443.46

Wall Mount Open Sided Shelf

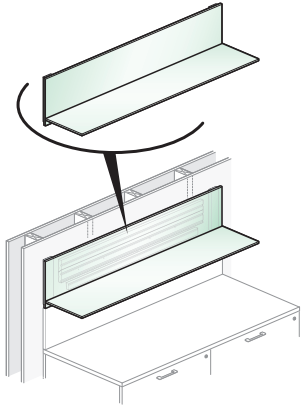

ULWL
UXWL
Class RA

Features

- Includes shelf with back panel with light block attached on each side, 4" (102mm) H french cleat with anti-dislodgement feature and attachment hardware.
- Shelf available:
 - High-Pressure Laminate or wood.
 - 30" (762mm) to 120" (3048mm) widths.
 - Letter or legal depth.
- 1H 17" (432mm) H unit has one fixed shelf.
- 2H 23" (584mm) H and 25" (635mm) H units have one fixed shelf.
- 2H 29" (737mm) H unit has two fixed shelves.
- 3H 36" (914mm) H, 38" (965mm) H, 39" (991mm) H and 40" (1016mm) H units have two fixed shelves.
- 4H 52" (1321mm) H units has three fixed shelves.
- Ships unassembled.

Specification Tips

- Must be properly anchored to structural building wall with field supplied anchors.
- See product application section of the Specification guide for adjacent upper storage component options.
- Wood grain laminate grain switches direction to horizontal at 60"W. Recommend dividing into multiple pieces when you want to synchronize vertical grain.
- Separately specify wall mount spacers to align the front face of lower tackboards or wall mounted glass tiles with the front face of a Open Sided Shelf.
- Commonly used above a separately specified tackboard.
- If a tackboard is required between 1.5H lower storage and 1.5H or 2H upper storage contact Tailored Solutions; tackboard height is not available as standard product.
- An Open Sided Shelf does not have a front valance and is not recommended for use with a task light; if specified the task light will be visible.
- See Specification Guide for weight limits.
- **To achieve proper alignment when installing Open Sided Shelves side by side, installation must be performed using eparts tool #TS00-1372 and field supplied dowels .315" (8mm) x 1.25" (32mm).**
- There is a .25" (6mm) gap between the shelf and lower storage or worksurface which can be used toroute power.
- Use separately specified Vertical Filler Trim to conceal installation details and provide a clean finish. Vertical Filler Trim adds 1/8" to the overall width of the application.

To Order, Specify:

HPL Surface:

1) Product number, including:

1 Top Shelf Alignment 17" (432mm) H only:

- S** Standard
- A** Align

2) Laminate surface color.

3) Edge trim color.

Wood Surface:

1) Product number, including:

1 Top Shelf Alignment 17" (432mm) H only:

- S** Standard
- A** Align

2) Wood finish for surface.

Wall Mount Open Sided Shelf

Nominal Height	Nominal Depth	Nominal Width	HPL Number ①	HPL A	HPL B	Wood Number ①	Wood A	Wood B
Letter Depth								
17"(432mm)	14"(356mm)	30"(762mm)	ULWL-1730-S1 LN	\$ 1107.90	\$ 1163.75	UXWL-1730-S1 XN	\$ 1272.42	\$ 1275.85
		36"(914mm)	ULWL-1736-S1 LN	1152.75	1217.09	UXWL-1736-S1 XN	1328.09	1332.09
		42"(1067mm)	ULWL-1742-S1 LN	1239.89	1310.76	UXWL-1742-S1 XN	1426.06	1430.63
		48"(1219mm)	ULWL-1748-S1 LN	1281.57	1360.94	UXWL-1748-S1 XN	1478.57	1483.71
		54"(1372mm)	ULWL-1754-S1 LN	1326.41	1412.30	UXWL-1754-S1 XN	1534.23	1539.94
		60"(1524mm)	ULWL-1760-S1 LN	1424.41	1518.79	UXWL-1760-S1 XN	1643.03	1649.31
		66"(1676mm)	ULWL-1766-S1 LN	1466.07	1566.99	UXWL-1766-S1 XN	1695.52	1702.38
		72"(1829mm)	ULWL-1772-S1 LN	1510.93	1620.33	UXWL-1772-S1 XN	1751.20	1758.63
		78"(1981mm)	ULWL-1778-S1 LN	1582.56	1698.49	UXWL-1778-S1 XN	1833.64	1841.64
		84"(2134mm)	ULWL-1784-S1 LN	1783.32	1907.74	UXWL-1784-S1 XN	2045.23	2053.81
		90"(2286mm)	ULWL-1790-S1 LN	1828.17	1959.12	UXWL-1790-S1 XN	2100.89	2110.03
		96"(2438mm)	ULWL-1796-S1 LN	1869.86	2009.30	UXWL-1796-S1 XN	2153.40	2163.12
		102"(2591mm)	ULWL-17A2-S1 LN	1914.69	2060.66	UXWL-17A2-S1 XN	2209.06	2219.34
		108"(2743mm)	ULWL-17A8-S1 LN	1956.39	2110.84	UXWL-17A8-S1 XN	2261.57	2272.43
		114"(2896mm)	ULWL-17B4-S1 LN	2001.23	2162.21	UXWL-17B4-S1 XN	2317.22	2328.65
		120"(3048mm)	ULWL-17C0-S1 LN	2042.91	2212.39	UXWL-17C0-S1 XN	2369.74	2381.74
23"(584mm)	14"(356mm)	30"(762mm)	ULWL-2330-S1SLN	\$ 1155.50	\$ 1220.44	UXWL-2330-S1SXN	\$ 1349.86	\$ 1354.37
		36"(914mm)	ULWL-2336-S1SLN	1208.34	1282.69	UXWL-2336-S1SXN	1418.76	1424.02
		42"(1067mm)	ULWL-2342-S1SLN	1303.46	1385.27	UXWL-2342-S1SXN	1529.95	1535.97
		48"(1219mm)	ULWL-2348-S1SLN	1353.14	1444.35	UXWL-2348-S1SXN	1595.70	1602.46
		54"(1372mm)	ULWL-2354-S1SLN	1405.98	1504.64	UXWL-2354-S1SXN	1664.58	1672.10
		60"(1524mm)	ULWL-2360-S1SLN	1511.96	1620.02	UXWL-2360-S1SXN	1786.61	1794.88
		66"(1676mm)	ULWL-2366-S1SLN	1561.62	1677.13	UXWL-2366-S1SXN	1852.33	1861.35
		72"(1829mm)	ULWL-2372-S1SLN	1614.46	1739.37	UXWL-2372-S1SXN	1921.23	1931.01
		78"(1981mm)	ULWL-2378-S1SLN	1694.08	1826.45	UXWL-2378-S1SXN	2016.90	2027.43
		84"(2134mm)	ULWL-2384-S1SLN	1902.85	2044.61	UXWL-2384-S1SXN	2241.73	2253.00
		90"(2286mm)	ULWL-2390-S1SLN	1955.68	2104.89	UXWL-2390-S1SXN	2310.61	2322.64
		96"(2438mm)	ULWL-2396-S1SLN	2005.36	2163.98	UXWL-2396-S1SXN	2376.35	2389.13
		102"(2591mm)	ULWL-23A2-S1SLN	2058.18	2224.25	UXWL-23A2-S1SXN	2445.23	2458.77
		108"(2743mm)	ULWL-23A8-S1SLN	2107.88	2283.35	UXWL-23A8-S1SXN	2510.97	2525.26
		114"(2896mm)	ULWL-23B4-S1SLN	2160.70	2343.61	UXWL-23B4-S1SXN	2579.86	2594.89
		120"(3048mm)	ULWL-23C0-S1SLN	2210.38	2402.71	UXWL-23C0-S1SXN	2645.60	2661.39
25"(635mm)	14"(356mm)	30"(762mm)	ULWL-2530-S1SLN	\$ 1179.28	\$ 1250.73	UXWL-2530-S2SXN	\$ 1381.14	\$ 1386.02
		36"(914mm)	ULWL-2536-S1SLN	1236.12	1317.43	UXWL-2536-S2SXN	1455.41	1461.11
		42"(1067mm)	ULWL-2542-S1SLN	1335.25	1424.47	UXWL-2542-S2SXN	1571.99	1578.49
		48"(1219mm)	ULWL-2548-S1SLN	1388.92	1488.01	UXWL-2548-S2SXN	1643.10	1650.41
		54"(1372mm)	ULWL-2554-S1SLN	1445.75	1552.74	UXWL-2554-S2SXN	1717.36	1725.49
		60"(1524mm)	ULWL-2560-S1SLN	1555.71	1672.57	UXWL-2560-S2SXN	1844.76	1853.70
		66"(1676mm)	ULWL-2566-S1SLN	1609.38	1734.15	UXWL-2566-S2SXN	1915.86	1925.61
		72"(1829mm)	ULWL-2572-S1SLN	1666.22	1800.84	UXWL-2572-S2SXN	1990.13	2000.70
		78"(1981mm)	ULWL-2578-S1SLN	1749.84	1892.37	UXWL-2578-S2SXN	2091.18	2102.56
		84"(2134mm)	ULWL-2584-S1SLN	1962.59	2114.98	UXWL-2584-S2SXN	2321.37	2333.56
		90"(2286mm)	ULWL-2590-S1SLN	2019.42	2179.72	UXWL-2590-S2SXN	2395.64	2408.64
		96"(2438mm)	ULWL-2596-S1SLN	2073.09	2243.26	UXWL-2596-S2SXN	2466.75	2480.56
		102"(2591mm)	ULWL-25A2-S1SLN	2129.92	2307.99	UXWL-25A2-S2SXN	2541.01	2555.63
		108"(2743mm)	ULWL-25A8-S1SLN	2183.60	2371.53	UXWL-25A8-S2SXN	2612.12	2627.56
		114"(2896mm)	ULWL-25B4-S1SLN	2240.42	2436.26	UXWL-25B4-S2SXN	2686.38	2702.63
		120"(3048mm)	ULWL-25C0-S1SLN	2294.10	2499.81	UXWL-25C0-S2SXN	2757.49	2774.55
29"(737mm)	14"(356mm)	30"(762mm)	ULWL-2930-S2SLN	\$ 1445.51	\$ 1540.10	UXWL-2930-S2SXN	\$ 1822.92	\$ 1828.51
		36"(914mm)	ULWL-2936-S2SLN	1528.73	1637.72	UXWL-2936-S2SXN	1921.71	1928.23
		42"(1067mm)	ULWL-2942-S2SLN	1654.25	1773.75	UXWL-2942-S2SXN	2062.81	2070.27
		48"(1219mm)	ULWL-2948-S2SLN	1731.14	1865.06	UXWL-2948-S2SXN	2155.28	2163.67
		54"(1372mm)	ULWL-2954-S2SLN	1814.34	1958.77	UXWL-2954-S2SXN	2254.07	2263.39
		60"(1524mm)	ULWL-2960-S2SLN	1950.67	2109.51	UXWL-2960-S2SXN	2405.99	2416.24
		66"(1676mm)	ULWL-2966-S2SLN	2027.56	2196.91	UXWL-2966-S2SXN	2498.46	2509.65
		72"(1829mm)	ULWL-2972-S2SLN	2110.78	2294.53	UXWL-2972-S2SXN	2597.25	2609.37
		78"(1981mm)	ULWL-2978-S2SLN	2220.78	2415.03	UXWL-2978-S2SXN	2722.83	2735.88
		84"(2134mm)	ULWL-2984-S2SLN	2456.74	2665.41	UXWL-2984-S2SXN	2974.38	2988.36
		90"(2286mm)	ULWL-2990-S2SLN	2539.95	2759.12	UXWL-2990-S2SXN	3073.17	3088.09
		96"(2438mm)	ULWL-2996-S2SLN	2616.84	2850.43	UXWL-2996-S2SXN	3165.64	3181.49
		102"(2591mm)	ULWL-29A2-S2SLN	2700.05	2944.14	UXWL-29A2-S2SXN	3264.43	3281.21
		108"(2743mm)	ULWL-29A8-S2SLN	2776.94	3035.43	UXWL-29A8-S2SXN	3356.90	3374.61
		114"(2896mm)	ULWL-29B4-S2SLN	2860.14	3129.15	UXWL-29B4-S2SXN	3455.69	3474.33
		120"(3048mm)	ULWL-29C0-S2SLN	2937.04	3220.45	UXWL-29C0-S2SXN	3548.16	3567.74

Wall Mount Open Sided Shelf

Nominal Height	Nominal Depth	Nominal Width	HPL Number	HPL A	HPL B	Wood Number	Wood A	Wood B
Letter Depth								
36"(914mm)	14"(356mm)	30"(762mm)	ULWL-3630-S2SLN	\$ 1493.09	\$ 1596.78	UXWL-3630-S2SXXN	\$ 1907.80	\$ 1914.66
		36"(914mm)	ULWL-3636-S2SLN	1584.30	1703.32	UXWL-3636-S2SXXN	2021.06	2029.06
		42"(1067mm)	ULWL-3642-S2SLN	1717.81	1848.25	UXWL-3642-S2SXXN	2176.63	2185.77
		48"(1219mm)	ULWL-3648-S2SLN	1802.69	1948.46	UXWL-3648-S2SXXN	2283.56	2293.85
		54"(1372mm)	ULWL-3654-S2SLN	1893.88	2051.08	UXWL-3654-S2SXXN	2396.82	2408.25
		60"(1524mm)	ULWL-3660-S2SLN	2038.20	2210.73	UXWL-3660-S2SXXN	2563.21	2575.78
		66"(1676mm)	ULWL-3666-S2SLN	2123.10	2307.05	UXWL-3666-S2SXXN	2670.15	2683.86
		72"(1829mm)	ULWL-3672-S2SLN	2214.29	2413.57	UXWL-3672-S2SXXN	2783.40	2798.26
		78"(1981mm)	ULWL-3678-S2SLN	2332.28	2542.97	UXWL-3678-S2SXXN	2923.45	2939.45
		84"(2134mm)	ULWL-3684-S2SLN	2576.24	2802.26	UXWL-3684-S2SXXN	3189.47	3206.61
		90"(2286mm)	ULWL-3690-S2SLN	2667.45	2904.89	UXWL-3690-S2SXXN	3302.73	3321.01
		96"(2438mm)	ULWL-3696-S2SLN	2752.32	3005.10	UXWL-3696-S2SXXN	3409.66	3429.09
		102"(2591mm)	ULWL-36A2-S2SLN	2843.52	3107.72	UXWL-36A2-S2SXXN	3522.92	3543.49
		108"(2743mm)	ULWL-36A8-S2SLN	2928.40	3207.92	UXWL-36A8-S2SXXN	3629.86	3651.57
114"(2896mm)	ULWL-36B4-S2SLN	3019.59	3310.55	UXWL-36B4-S2SXXN	3743.12	3765.97		
		120"(3048mm)	ULWL-36C0-S2SLN	3104.49	3410.77	N/A	N/A	N/A
38"(965mm)	14"(356mm)	30"(762mm)	ULWL-3830-S2SLN	\$ 1674.92	\$ 1784.26	UXWL-3830-S2SXXN	\$ 2001.08	\$ 2008.30
		36"(914mm)	ULWL-3836-S2SLN	1768.79	1893.76	UXWL-3836-S2SXXN	2118.75	2127.17
		42"(1067mm)	ULWL-3842-S2SLN	1947.29	2083.98	UXWL-3842-S2SXXN	2321.05	2330.67
		48"(1219mm)	ULWL-3848-S2SLN	2034.83	2187.16	UXWL-3848-S2SXXN	2432.39	2443.22
		54"(1372mm)	ULWL-3854-S2SLN	2128.70	2292.75	UXWL-3854-S2SXXN	2550.06	2562.09
		60"(1524mm)	ULWL-3860-S2SLN	2328.81	2508.50	UXWL-3860-S2SXXN	2773.99	2787.22
		66"(1676mm)	ULWL-3866-S2SLN	2416.36	2607.78	UXWL-3866-S2SXXN	2885.34	2899.77
		72"(1829mm)	ULWL-3872-S2SLN	2510.22	2717.27	UXWL-3872-S2SXXN	3003.00	3018.64
		78"(1981mm)	ULWL-3878-S2SLN	2630.87	2849.65	UXWL-3878-S2SXXN	3147.46	3164.30
		84"(2134mm)	ULWL-3884-S2SLN	3036.57	3270.98	UXWL-3884-S2SXXN	3576.96	3595.00
		90"(2286mm)	ULWL-3890-S2SLN	3130.43	3376.57	UXWL-3890-S2SXXN	3694.62	3713.87
		96"(2438mm)	ULWL-3896-S2SLN	3217.97	3479.75	UXWL-3896-S2SXXN	3805.97	3826.42
		102"(2591mm)	ULWL-38A2-S2SLN	3311.83	3585.34	UXWL-38A2-S2SXXN	3923.64	3945.29
		108"(2743mm)	ULWL-38A8-S2SLN	3399.38	3688.52	UXWL-38A8-S2SXXN	4034.98	4057.84
114"(2896mm)	ULWL-38B4-S2SLN	3493.24	3794.11	N/A	N/A	N/A		
		120"(3048mm)	ULWL-38C0-S2SLN	3580.80	3897.29	N/A	N/A	N/A
39"(991mm)	14"(356mm)	30"(762mm)	ULWL-3930-S2SLN	\$ 1682.85	\$ 1793.04	UXWL-3930-S2SXXN	\$ 2006.54	\$ 2013.76
		36"(914mm)	ULWL-3936-S2SLN	1778.06	1904.03	UXWL-3936-S2SXXN	2125.18	2133.60
		42"(1067mm)	ULWL-3942-S2SLN	1957.87	2095.72	UXWL-3942-S2SXXN	2328.44	2338.06
		48"(1219mm)	ULWL-3948-S2SLN	2046.76	2200.40	UXWL-3948-S2SXXN	2440.75	2451.58
		54"(1372mm)	ULWL-3954-S2SLN	2141.95	2307.47	UXWL-3954-S2SXXN	2559.38	2571.41
		60"(1524mm)	ULWL-3960-S2SLN	2343.40	2524.71	UXWL-3960-S2SXXN	2784.28	2797.51
		66"(1676mm)	ULWL-3966-S2SLN	2432.27	2625.47	UXWL-3966-S2SXXN	2896.59	2911.02
		72"(1829mm)	ULWL-3972-S2SLN	2527.47	2736.44	UXWL-3972-S2SXXN	3015.22	3030.86
		78"(1981mm)	ULWL-3978-S2SLN	2649.46	2870.31	UXWL-3978-S2SXXN	3160.64	3177.48
		84"(2134mm)	ULWL-3984-S2SLN	3056.49	3293.13	UXWL-3984-S2SXXN	3591.11	3609.15
		90"(2286mm)	ULWL-3990-S2SLN	3151.67	3400.20	UXWL-3990-S2SXXN	3709.73	3728.98
		96"(2438mm)	ULWL-3996-S2SLN	3240.55	3504.87	UXWL-3996-S2SXXN	3822.05	3842.50
		102"(2591mm)	ULWL-39A2-S2SLN	3335.75	3611.94	UXWL-39A2-S2SXXN	3940.68	3962.33
		108"(2743mm)	ULWL-39A8-S2SLN	3424.63	3716.60	UXWL-39A8-S2SXXN	4052.99	4075.85
114"(2896mm)	ULWL-39B4-S2SLN	3519.82	3823.68	N/A	N/A	N/A		
		120"(3048mm)	ULWL-39C0-S2SLN	3608.70	3928.35	N/A	N/A	N/A
40"(1016mm)	14"(356mm)	30"(762mm)	ULWL-4030-S2SLN	\$ 1690.77	\$ 1801.84	UXWL-4030-S2SXXN	\$ 2026.89	\$ 2034.46
		36"(914mm)	ULWL-4036-S2SLN	1787.31	1914.31	UXWL-4036-S2SXXN	2148.96	2157.80
		42"(1067mm)	ULWL-4042-S2SLN	1968.47	2107.50	UXWL-4042-S2SXXN	2355.67	2365.77
		48"(1219mm)	ULWL-4048-S2SLN	2058.68	2213.65	UXWL-4048-S2SXXN	2471.43	2482.79
		54"(1372mm)	ULWL-4054-S2SLN	2155.20	2322.21	UXWL-4054-S2SXXN	2593.50	2606.13
		60"(1524mm)	ULWL-4060-S2SLN	2357.97	2540.93	UXWL-4060-S2SXXN	2821.84	2835.73
		66"(1676mm)	ULWL-4066-S2SLN	2448.19	2643.17	UXWL-4066-S2SXXN	2937.60	2952.75
		72"(1829mm)	ULWL-4072-S2SLN	2544.72	2755.64	UXWL-4072-S2SXXN	3059.67	3076.09
		78"(1981mm)	ULWL-4078-S2SLN	2668.04	2890.99	UXWL-4078-S2SXXN	3208.54	3226.22
		84"(2134mm)	ULWL-4084-S2SLN	3076.39	3315.29	UXWL-4084-S2SXXN	3642.44	3661.39
		90"(2286mm)	ULWL-4090-S2SLN	3172.92	3423.84	UXWL-4090-S2SXXN	3764.52	3784.73
		96"(2438mm)	ULWL-4096-S2SLN	3263.13	3530.00	UXWL-4096-S2SXXN	3880.28	3901.75
		102"(2591mm)	ULWL-40A2-S2SLN	3359.66	3638.56	UXWL-40A2-S2SXXN	4002.35	4025.09
		108"(2743mm)	ULWL-40A8-S2SLN	3449.86	3744.70	UXWL-40A8-S2SXXN	4118.11	4142.11
114"(2896mm)	ULWL-40B4-S2SLN	3546.39	3853.26	N/A	N/A	N/A		
		120"(3048mm)	ULWL-40C0-S2SLN	3636.60	3959.41	N/A	N/A	N/A

Wall Mount Open Sided Shelf

Nominal Height	Nominal Depth	Nominal Width	HPL Number	HPL A	HPL B	Wood Number	Wood A	Wood B
Letter Depth								
52"(1321mm)	14"(356mm)	30"(762mm)	ULWL-5230-S3SLN	\$2028.40	\$ 2178.20	UXWL-5230-S3SXN	\$ 2577.38	\$ 2587.12
		36"(914mm)	ULWL-5236-S3SLN	2163.30	2334.96	UXWL-5236-S3SXN	2742.59	2753.96
		42"(1067mm)	ULWL-5242-S3SLN	2382.81	2570.47	UXWL-5242-S3SXN	2992.41	3005.40
		48"(1219mm)	ULWL-5248-S3SLN	2508.22	2717.75	UXWL-5248-S3SXN	3148.14	3162.76
		54"(1372mm)	ULWL-5254-S3SLN	2643.11	2868.65	N/A	N/A	N/A
		60"(1524mm)	ULWL-5260-S3SLN	2884.28	3131.67	N/A	N/A	N/A
		66"(1676mm)	ULWL-5266-S3SLN	3009.67	3273.09	N/A	N/A	N/A
		72"(1829mm)	ULWL-5272-S3SLN	3144.57	3429.84	N/A	N/A	N/A
		78"(1981mm)	ULWL-5278-S3SLN	3306.26	3607.54	N/A	N/A	N/A
		84"(2134mm)	ULWL-5284-S3SLN	3749.82	4072.96	N/A	N/A	N/A
		90"(2286mm)	ULWL-5290-S3SLN	3884.70	4223.85	N/A	N/A	N/A
		96"(2438mm)	ULWL-5296-S3SLN	4010.12	4371.14	N/A	N/A	N/A
		102"(2591mm)	ULWL-52A2-S3SLN	4145.00	4522.02	N/A	N/A	N/A
		108"(2743mm)	ULWL-52A8-S3SLN	4270.44	4669.31	N/A	N/A	N/A
		114"(2896mm)	ULWL-52B4-S3SLN	4405.32	4820.21	N/A	N/A	N/A
		120"(3048mm)	ULWL-52C0-S3SLN	4530.72	4967.48	N/A	N/A	N/A

Wall Mount Open Sided Shelf

Nominal Height	Nominal Depth	Nominal Width	HPL Number ①	HPL A	HPL B	Wood Number ①	Wood A	Wood B
Legal Depth								
17"(432mm)	16.5"(419mm)	30"(762mm)	ULWD-1730-S1 LN	\$ 1128.45	\$ 1188.55	UXWD-1730-S1 XN	\$ 1286.90	\$ 1290.33
		36"(914mm)	ULWD-1736-S1 LN	1177.30	1244.39	UXWD-1736-S1 XN	1345.46	1349.46
		42"(1067mm)	ULWD-1742-S1 LN	1268.44	1344.47	UXWD-1742-S1 XN	1446.33	1450.90
		48"(1219mm)	ULWD-1748-S1 LN	1314.12	1397.15	UXWD-1748-S1 XN	1501.73	1506.87
		54"(1372mm)	ULWD-1754-S1 LN	1362.96	1454.93	UXWD-1754-S1 XN	1560.29	1566.00
		60"(1524mm)	ULWD-1760-S1 LN	1464.94	1563.90	UXWD-1760-S1 XN	1671.98	1678.26
		66"(1676mm)	ULWD-1766-S1 LN	1510.61	1618.52	UXWD-1766-S1 XN	1727.37	1734.23
		72"(1829mm)	ULWD-1772-S1 LN	1559.46	1674.36	UXWD-1772-S1 XN	1785.94	1793.37
		78"(1981mm)	ULWD-1778-S1 LN	1635.08	1758.92	UXWD-1778-S1 XN	1871.28	1879.28
		84"(2134mm)	ULWD-1784-S1 LN	1839.84	1970.68	UXWD-1784-S1 XN	2085.76	2094.34
		90"(2286mm)	ULWD-1790-S1 LN	1888.68	2028.46	UXWD-1790-S1 XN	2144.32	2153.46
		96"(2438mm)	ULWD-1796-S1 LN	1934.37	2081.14	UXWD-1796-S1 XN	2199.72	2209.44
		102"(2591mm)	ULWD-17A2-S1 LN	1983.20	2138.92	UXWD-17A2-S1 XN	2258.28	2268.56
		108"(2743mm)	ULWD-17A8-S1 LN	2028.88	2191.58	UXWD-17A8-S1 XN	2313.68	2324.54
		114"(2896mm)	ULWD-17B4-S1 LN	2077.73	2249.38	UXWD-17B4-S1 XN	2372.23	2383.66
		120"(3048mm)	ULWD-17C0-S1 LN	2123.40	2302.04	UXWD-17C0-S1 XN	2427.64	2439.64
23"(584mm)	16.5"(419mm)	30"(762mm)	ULWD-2330-S1SLN	\$ 1176.05	\$ 1245.24	UXWD-2330-S1SXN	\$ 1364.34	\$ 1368.85
		36"(914mm)	ULWD-2336-S1SLN	1232.89	1309.99	UXWD-2336-S1SXN	1436.13	1441.39
		42"(1067mm)	ULWD-2342-S1SLN	1332.01	1418.98	UXWD-2342-S1SXN	1550.22	1556.24
		48"(1219mm)	ULWD-2348-S1SLN	1385.69	1480.56	UXWD-2348-S1SXN	1618.86	1625.62
		54"(1372mm)	ULWD-2354-S1SLN	1442.53	1547.27	UXWD-2354-S1SXN	1690.64	1698.16
		60"(1524mm)	ULWD-2360-S1SLN	1552.49	1665.13	UXWD-2360-S1SXN	1815.56	1823.83
		66"(1676mm)	ULWD-2366-S1SLN	1606.16	1728.66	UXWD-2366-S1SXN	1884.18	1893.20
		72"(1829mm)	ULWD-2372-S1SLN	1662.99	1793.40	UXWD-2372-S1SXN	1955.97	1965.75
		78"(1981mm)	ULWD-2378-S1SLN	1746.60	1886.88	UXWD-2378-S1SXN	2054.54	2065.07
		84"(2134mm)	ULWD-2384-S1SLN	1959.37	2107.55	UXWD-2384-S1SXN	2282.26	2293.53
		90"(2286mm)	ULWD-2390-S1SLN	2016.19	2174.23	UXWD-2390-S1SXN	2354.04	2366.07
		96"(2438mm)	ULWD-2396-S1SLN	2069.87	2235.82	UXWD-2396-S1SXN	2422.67	2435.45
		102"(2591mm)	ULWD-23A2-S1SLN	2126.69	2302.51	UXWD-23A2-S1SXN	2494.45	2507.99
		108"(2743mm)	ULWD-23A8-S1SLN	2180.37	2364.09	UXWD-23A8-S1SXN	2563.08	2577.37
		114"(2896mm)	ULWD-23B4-S1SLN	2237.20	2430.78	UXWD-23B4-S1SXN	2634.87	2649.90
		120"(3048mm)	ULWD-23C0-S1SLN	2290.87	2492.36	UXWD-23C0-S1SXN	2703.50	2719.29
25"(635mm)	16.5"(419mm)	30"(762mm)	ULWD-2530-S1SLN	\$ 1199.83	\$ 1275.53	UXWD-2530-S2SXN	\$ 1395.62	\$ 1400.50
		36"(914mm)	ULWD-2536-S1SLN	1260.67	1344.73	UXWD-2536-S2SXN	1472.78	1478.48
		42"(1067mm)	ULWD-2542-S1SLN	1363.80	1458.18	UXWD-2542-S2SXN	1592.26	1598.76
		48"(1219mm)	ULWD-2548-S1SLN	1421.47	1524.22	UXWD-2548-S2SXN	1666.26	1673.57
		54"(1372mm)	ULWD-2554-S1SLN	1482.30	1595.37	UXWD-2554-S2SXN	1743.42	1751.55
		60"(1524mm)	ULWD-2560-S1SLN	1596.24	1717.68	UXWD-2560-S2SXN	1873.71	1882.65
		66"(1676mm)	ULWD-2566-S1SLN	1653.92	1785.68	UXWD-2566-S2SXN	1947.71	1957.46
		72"(1829mm)	ULWD-2572-S1SLN	1714.75	1854.87	UXWD-2572-S2SXN	2024.87	2035.44
		78"(1981mm)	ULWD-2578-S1SLN	1802.36	1952.80	UXWD-2578-S2SXN	2128.82	2140.20
		84"(2134mm)	ULWD-2584-S1SLN	2019.11	2177.92	UXWD-2584-S2SXN	2361.90	2374.09
		90"(2286mm)	ULWD-2590-S1SLN	2079.93	2249.06	UXWD-2590-S2SXN	2439.07	2452.07
		96"(2438mm)	ULWD-2596-S1SLN	2137.60	2315.10	UXWD-2596-S2SXN	2513.07	2526.88
		102"(2591mm)	ULWD-25A2-S1SLN	2198.43	2386.25	UXWD-25A2-S2SXN	2590.23	2604.85
		108"(2743mm)	ULWD-25A8-S1SLN	2256.09	2452.27	UXWD-25A8-S2SXN	2664.23	2679.67
		114"(2896mm)	ULWD-25B4-S1SLN	2316.92	2523.43	UXWD-25B4-S2SXN	2741.39	2757.64
		120"(3048mm)	ULWD-25C0-S1SLN	2374.59	2589.46	UXWD-25C0-S2SXN	2815.39	2832.45
29"(737mm)	16.5"(419mm)	30"(762mm)	ULWD-2930-S2SLN	\$ 1486.63	\$ 1589.70	UXWD-2930-S2SXN	\$ 1851.87	\$ 1857.46
		36"(914mm)	ULWD-2936-S2SLN	1577.83	1692.32	UXWD-2936-S2SXN	1956.45	1962.97
		42"(1067mm)	ULWD-2942-S2SLN	1711.34	1841.16	UXWD-2942-S2SXN	2103.34	2110.80
		48"(1219mm)	ULWD-2948-S2SLN	1796.22	1937.47	UXWD-2948-S2SXN	2201.60	2209.99
		54"(1372mm)	ULWD-2954-S2SLN	1887.41	2043.99	UXWD-2954-S2SXN	2306.18	2315.50
		60"(1524mm)	ULWD-2960-S2SLN	2031.75	2199.75	UXWD-2960-S2SXN	2463.89	2474.14
		66"(1676mm)	ULWD-2966-S2SLN	2116.62	2299.95	UXWD-2966-S2SXN	2562.15	2573.34
		72"(1829mm)	ULWD-2972-S2SLN	2207.83	2402.58	UXWD-2972-S2SXN	2666.73	2678.85
		78"(1981mm)	ULWD-2978-S2SLN	2325.81	2535.89	UXWD-2978-S2SXN	2798.10	2811.15
		84"(2134mm)	ULWD-2984-S2SLN	2569.76	2791.27	UXWD-2984-S2SXN	3055.44	3069.42
		90"(2286mm)	ULWD-2990-S2SLN	2660.97	2897.80	UXWD-2990-S2SXN	3160.02	3174.94
		96"(2438mm)	ULWD-2996-S2SLN	2745.85	2994.11	UXWD-2996-S2SXN	3258.28	3274.13
		102"(2591mm)	ULWD-29A2-S2SLN	2837.05	3100.63	UXWD-29A2-S2SXN	3362.86	3379.64
		108"(2743mm)	ULWD-29A8-S2SLN	2921.93	3196.93	UXWD-29A8-S2SXN	3461.12	3478.83
		114"(2896mm)	ULWD-29B4-S2SLN	3013.13	3303.46	UXWD-29B4-S2SXN	3565.70	3584.34
		120"(3048mm)	ULWD-29C0-S2SLN	3098.01	3399.76	UXWD-29C0-S2SXN	3663.96	3683.54

Wall Mount Open Sided Shelf

Nominal Height	Nominal Depth	Nominal Width	HPL Number	HPL A	HPL B	Wood Number	Wood A	Wood B
Legal Depth								
36"(914mm)	16.5"(419mm)	30"(762mm)	ULWD-3630-S2SLN	\$ 1534.21	\$ 1646.38	UXWD-3630-S2SXX	\$ 1936.75	\$ 1943.61
		36"(914mm)	ULWD-3636-S2SLN	1633.40	1757.92	UXWD-3636-S2SXX	2055.80	2063.80
		42"(1067mm)	ULWD-3642-S2SLN	1774.90	1915.66	UXWD-3642-S2SXX	2217.16	2226.30
		48"(1219mm)	ULWD-3648-S2SLN	1867.77	2020.87	UXWD-3648-S2SXX	2329.88	2340.17
		54"(1372mm)	ULWD-3654-S2SLN	1966.95	2136.30	UXWD-3654-S2SXX	2448.93	2460.36
		60"(1524mm)	ULWD-3660-S2SLN	2119.28	2300.97	UXWD-3660-S2SXX	2621.11	2633.68
		66"(1676mm)	ULWD-3666-S2SLN	2212.16	2410.09	UXWD-3666-S2SXX	2733.84	2747.55
		72"(1829mm)	ULWD-3672-S2SLN	2311.34	2521.62	UXWD-3672-S2SXX	2852.88	2867.74
		78"(1981mm)	ULWD-3678-S2SLN	2437.31	2663.83	UXWD-3678-S2SXX	2998.72	3014.72
		84"(2134mm)	ULWD-3684-S2SLN	2689.26	2928.12	UXWD-3684-S2SXX	3270.53	3287.67
		90"(2286mm)	ULWD-3690-S2SLN	2788.47	3043.57	UXWD-3690-S2SXX	3389.58	3407.86
		96"(2438mm)	ULWD-3696-S2SLN	2881.33	3148.78	UXWD-3696-S2SXX	3502.30	3521.73
		102"(2591mm)	ULWD-36A2-S2SLN	2980.52	3264.21	UXWD-36A2-S2SXX	3621.35	3641.92
		108"(2743mm)	ULWD-36A8-S2SLN	3073.39	3369.42	UXWD-36A8-S2SXX	3734.08	3755.79
		114"(2896mm)	ULWD-36B4-S2SLN	3172.58	3484.86	UXWD-36B4-S2SXX	3853.13	3875.98
		120"(3048mm)	ULWD-36C0-S2SLN	3265.46	3590.08	N/A	N/A	N/A
38"(965mm)	16.5"(419mm)	30"(762mm)	ULWD-3830-S2SLN	\$ 1716.04	\$ 1833.86	UXWD-3830-S2SXX	\$ 2030.03	\$ 2037.25
		36"(914mm)	ULWD-3836-S2SLN	1817.89	1948.36	UXWD-3836-S2SXX	2153.49	2161.91
		42"(1067mm)	ULWD-3842-S2SLN	2004.38	2151.39	UXWD-3842-S2SXX	2361.58	2371.20
		48"(1219mm)	ULWD-3848-S2SLN	2099.91	2259.57	UXWD-3848-S2SXX	2478.71	2489.54
		54"(1372mm)	ULWD-3854-S2SLN	2201.77	2377.97	UXWD-3854-S2SXX	2602.17	2614.20
		60"(1524mm)	ULWD-3860-S2SLN	2409.89	2598.74	UXWD-3860-S2SXX	2831.89	2845.12
		66"(1676mm)	ULWD-3866-S2SLN	2505.42	2710.82	UXWD-3866-S2SXX	2949.03	2963.46
		72"(1829mm)	ULWD-3872-S2SLN	2607.27	2825.32	UXWD-3872-S2SXX	3072.48	3088.12
		78"(1981mm)	ULWD-3878-S2SLN	2735.90	2970.51	UXWD-3878-S2SXX	3222.73	3239.57
		84"(2134mm)	ULWD-3884-S2SLN	3149.59	3396.84	UXWD-3884-S2SXX	3658.02	3676.06
		90"(2286mm)	ULWD-3890-S2SLN	3251.45	3515.25	UXWD-3890-S2SXX	3781.47	3800.72
		96"(2438mm)	ULWD-3896-S2SLN	3346.98	3623.43	UXWD-3896-S2SXX	3898.61	3919.06
		102"(2591mm)	ULWD-38A2-S2SLN	3448.83	3741.83	UXWD-38A2-S2SXX	4022.07	4043.72
		108"(2743mm)	ULWD-38A8-S2SLN	3544.37	3850.02	UXWD-38A8-S2SXX	4139.20	4162.06
		114"(2896mm)	ULWD-38B4-S2SLN	3646.23	3968.42	N/A	N/A	N/A
		120"(3048mm)	ULWD-38C0-S2SLN	3741.77	4076.60	N/A	N/A	N/A
39"(991mm)	16.5"(419mm)	30"(762mm)	ULWD-3930-S2SLN	\$ 1723.97	\$ 1842.64	UXWD-3930-S2SXX	\$ 2035.49	\$ 2042.71
		36"(914mm)	ULWD-3936-S2SLN	1827.16	1958.63	UXWD-3936-S2SXX	2159.92	2168.34
		42"(1067mm)	ULWD-3942-S2SLN	2014.96	2163.13	UXWD-3942-S2SXX	2368.97	2378.59
		48"(1219mm)	ULWD-3948-S2SLN	2111.84	2272.81	UXWD-3948-S2SXX	2487.07	2497.90
		54"(1372mm)	ULWD-3954-S2SLN	2215.02	2392.69	UXWD-3954-S2SXX	2611.49	2623.52
		60"(1524mm)	ULWD-3960-S2SLN	2424.48	2614.95	UXWD-3960-S2SXX	2842.18	2855.41
		66"(1676mm)	ULWD-3966-S2SLN	2521.33	2728.51	UXWD-3966-S2SXX	2960.28	2974.71
		72"(1829mm)	ULWD-3972-S2SLN	2624.52	2844.49	UXWD-3972-S2SXX	3084.70	3100.34
		78"(1981mm)	ULWD-3978-S2SLN	2754.49	2991.17	UXWD-3978-S2SXX	3235.91	3252.75
		84"(2134mm)	ULWD-3984-S2SLN	3169.51	3418.99	UXWD-3984-S2SXX	3672.17	3690.21
		90"(2286mm)	ULWD-3990-S2SLN	3272.69	3538.88	UXWD-3990-S2SXX	3796.58	3815.83
		96"(2438mm)	ULWD-3996-S2SLN	3369.56	3648.55	UXWD-3996-S2SXX	3914.69	3935.14
		102"(2591mm)	ULWD-39A2-S2SLN	3472.75	3768.43	UXWD-39A2-S2SXX	4039.11	4060.76
		108"(2743mm)	ULWD-39A8-S2SLN	3569.62	3878.10	UXWD-39A8-S2SXX	4157.21	4180.07
		114"(2896mm)	ULWD-39B4-S2SLN	3672.81	3997.99	N/A	N/A	N/A
		120"(3048mm)	ULWD-39C0-S2SLN	3769.67	4107.66	N/A	N/A	N/A
40"(1016mm)	16.5"(419mm)	30"(762mm)	ULWD-4030-S3SLN	\$ 1731.89	\$ 1851.44	UXWD-4030-S3SXX	\$ 2055.84	\$ 2063.41
		36"(914mm)	ULWD-4036-S3SLN	1836.41	1968.91	UXWD-4036-S3SXX	2183.70	2192.54
		42"(1067mm)	ULWD-4042-S3SLN	2025.56	2174.91	UXWD-4042-S3SXX	2396.20	2406.30
		48"(1219mm)	ULWD-4048-S3SLN	2123.76	2286.06	UXWD-4048-S3SXX	2517.75	2529.11
		54"(1372mm)	ULWD-4054-S3SLN	2228.27	2407.43	UXWD-4054-S3SXX	2645.61	2658.24
		60"(1524mm)	ULWD-4060-S3SLN	2439.05	2631.17	UXWD-4060-S3SXX	2879.74	2893.63
		66"(1676mm)	ULWD-4066-S3SLN	2537.25	2746.21	UXWD-4066-S3SXX	3001.29	3016.44
		72"(1829mm)	ULWD-4072-S3SLN	2641.77	2863.69	UXWD-4072-S3SXX	3129.15	3145.57
		78"(1981mm)	ULWD-4078-S3SLN	2773.07	3011.85	UXWD-4078-S3SXX	3283.81	3301.49
		84"(2134mm)	ULWD-4084-S3SLN	3189.41	3441.15	UXWD-4084-S3SXX	3723.50	3742.45
		90"(2286mm)	ULWD-4090-S3SLN	3293.94	3562.52	UXWD-4090-S3SXX	3851.37	3871.58
		96"(2438mm)	ULWD-4096-S3SLN	3392.14	3673.68	UXWD-4096-S3SXX	3972.92	3994.39
		102"(2591mm)	ULWD-40A2-S3SLN	3496.66	3795.05	UXWD-40A2-S3SXX	4100.78	4123.52
		108"(2743mm)	ULWD-40A8-S3SLN	3594.85	3906.20	UXWD-40A8-S3SXX	4222.33	4246.33
		114"(2896mm)	ULWD-40B4-S3SLN	3699.38	4027.57	N/A	N/A	N/A
		120"(3048mm)	ULWD-40C0-S3SLN	3797.57	4138.72	N/A	N/A	N/A

Wall Mount Open Sided Shelf

Nominal Height	Nominal Depth	Nominal Width	HPL Number	HPL A	HPL B	Wood Number	Wood A	Wood B
Legal Depth								
52"(1321mm)	16.5"(419mm)	30"(762mm)	ULWD-5230-S3SLN	\$2090.07	\$2252.60	UXWD-5230-S3SXN	\$2620.81	\$2630.55
		36"(914mm)	ULWD-5236-S3SLN	2236.95	2416.86	UXWD-5236-S3SXN	2794.70	2806.07
		42"(1067mm)	ULWD-5242-S3SLN	2468.45	2671.59	UXWD-5242-S3SXN	3053.21	3066.20
		48"(1219mm)	ULWD-5248-S3SLN	2605.85	2826.38	UXWD-5248-S3SXN	3217.62	3232.24
		54"(1372mm)	ULWD-5254-S3SLN	2752.72	2996.50	N/A	N/A	N/A
		60"(1524mm)	ULWD-5260-S3SLN	3005.87	3267.02	N/A	N/A	N/A
		66"(1676mm)	ULWD-5266-S3SLN	3143.26	3427.66	N/A	N/A	N/A
		72"(1829mm)	ULWD-5272-S3SLN	3290.14	3591.92	N/A	N/A	N/A
		78"(1981mm)	ULWD-5278-S3SLN	3463.81	3788.83	N/A	N/A	N/A
		84"(2134mm)	ULWD-5284-S3SLN	3919.36	4261.76	N/A	N/A	N/A
		90"(2286mm)	ULWD-5290-S3SLN	4066.24	4431.87	N/A	N/A	N/A
		96"(2438mm)	ULWD-5296-S3SLN	4203.64	4586.66	N/A	N/A	N/A
		102"(2591mm)	ULWD-52A2-S3SLN	4350.51	4756.77	N/A	N/A	N/A
		108"(2743mm)	ULWD-52A8-S3SLN	4487.93	4911.56	N/A	N/A	N/A
		114"(2896mm)	ULWD-52B4-S3SLN	4634.79	5081.67	N/A	N/A	N/A
		120"(3048mm)	ULWD-52C0-S3SLN	4772.19	5236.45	N/A	N/A	N/A

Wall Mount L Shelf

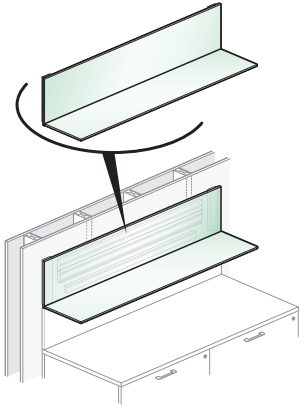

ULVL
UXVL
Class RA

Features

- Includes shelf with back panel with light block attached on each side, 4"(102mm)H french cleat with anti-dislodgement feature.
- Available in high-pressure laminate (HPL) or wood.
- Shelf available from 30"(762mm) to 120"(3048mm)W.
- Shelf available in letter and legal depth.
- 1H 14"(356mm)H and 15"(381mm)H has one fixed shelf.
- 2H 27"(686mm)H has two fixed shelves.
- Ships unassembled.

Specification Tips

- Shelf Heights and Alignment:
 - 1H L Shelf may be specified with standard or aligned heights to ensure alignment with shelves of adjacent components:
 - Standard Height (15"H) - designed for mounting the L Shelf @5H.
 - Aligned Height (14"H) - designed for mounting the L Shelf @6H.
 - 2H L Shelf is only available in standard height (27"H), designed for mounting the L Shelf @6H.
- Mounts on structural building wall. 30"(762mm)W cannot be mounted on 24"(610mm) commercial stud spacing. Metal shelf needs to attach to two studs.
- Must be properly anchored to structural building wall with field supplied anchors.
- Letter (14"(356mm)) or legal (16.5"(419mm))D can be used for binder storage.
- Cannot mount lower than 38"(965mm) off floor.
- Use separately specified Vertical Filler Trim to conceal installation details and provide a clean finish. Vertical Filler Trim adds .125"(3mm) to the overall width of the application.
- Refer to Specification Guide for weight limitations and application information.

To Order, Specify:

- 1) Product number.
- 2) Finish code (laminate or wood).
- 3) Edge trim color (laminate only).

Note: The L Shelf is not designed to function as a seat or heavy storage voids warranty.

Wall Mount L Shelf

Nominal Height	Nominal Depth	Nominal Width	HPL Number	HPL		Wood Number	Wood	
				A	B		A	B
Letter Depth								
14"(356mm)	14"(356mm)	30"(762mm)	ULVL-1430-SIALN	\$ 1084.11	\$ 1137.37	UXVL-1430-SIAXN	\$ 1233.71	\$ 1236.59
		36"(914mm)	ULVL-1436-SIALN	1124.96	1186.24	UXVL-1436-SIAXN	1282.76	1286.13
		42"(1067mm)	ULVL-1442-SIALN	1208.10	1275.47	UXVL-1442-SIAXN	1374.12	1377.96
		48"(1219mm)	ULVL-1448-SIALN	1245.80	1321.20	UXVL-1448-SIAXN	1420.01	1424.34
		54"(1372mm)	ULVL-1454-SIALN	1286.64	1368.11	UXVL-1454-SIAXN	1469.05	1473.87
		60"(1524mm)	ULVL-1460-SIALN	1380.63	1470.13	UXVL-1460-SIAXN	1571.24	1576.53
		66"(1676mm)	ULVL-1466-SIALN	1418.31	1513.88	UXVL-1466-SIAXN	1617.12	1622.90
		72"(1829mm)	ULVL-1472-SIALN	1459.16	1562.76	UXVL-1472-SIAXN	1666.18	1672.43
		78"(1981mm)	ULVL-1478-SIALN	1526.81	1636.48	UXVL-1478-SIAXN	1742.01	1748.75
		84"(2134mm)	ULVL-1484-SIALN	1723.58	1841.27	UXVL-1484-SIAXN	1946.99	1954.21
		90"(2286mm)	ULVL-1490-SIALN	1764.42	1888.19	UXVL-1490-SIAXN	1996.03	2003.73
		96"(2438mm)	ULVL-1496-SIALN	1802.11	1933.91	UXVL-1496-SIAXN	2041.93	2050.11
		102"(2591mm)	ULVL-14A2-SIALN	1842.95	1980.83	UXVL-14A2-SIAXN	2090.97	2099.63
		108"(2743mm)	ULVL-14A8-SIALN	1880.66	2026.56	UXVL-14A8-SIAXN	2136.87	2146.01
114"(2896mm)	ULVL-14B4-SIALN	1921.50	2073.47	UXVL-14B4-SIAXN	2185.91	2195.54		
120"(3048mm)	ULVL-14C0-SIALN	1959.18	2119.19	UXVL-14C0-SIAXN	2231.81	2241.91		
15"(381mm)	14"(356mm)	30"(762mm)	ULVL-1530-SISLN	\$ 1092.03	\$ 1146.16	UXVL-1530-SISXN	\$ 1246.61	\$ 1249.67
		36"(914mm)	ULVL-1536-SISLN	1134.22	1196.52	UXVL-1536-SISXN	1297.87	1301.45
		42"(1067mm)	ULVL-1542-SISLN	1218.70	1287.24	UXVL-1542-SISXN	1391.43	1395.52
		48"(1219mm)	ULVL-1548-SISLN	1257.72	1334.44	UXVL-1548-SISXN	1439.53	1444.13
		54"(1372mm)	ULVL-1554-SISLN	1299.90	1382.84	UXVL-1554-SISXN	1490.78	1495.89
		60"(1524mm)	ULVL-1560-SISLN	1395.22	1486.34	UXVL-1560-SISXN	1595.17	1600.79
		66"(1676mm)	ULVL-1566-SISLN	1434.22	1531.58	UXVL-1566-SISXN	1643.25	1649.39
		72"(1829mm)	ULVL-1572-SISLN	1476.43	1581.95	UXVL-1572-SISXN	1694.52	1701.16
		78"(1981mm)	ULVL-1578-SISLN	1545.39	1657.15	UXVL-1578-SISXN	1772.55	1779.71
		84"(2134mm)	ULVL-1584-SISLN	1743.49	1863.42	UXVL-1584-SISXN	1979.74	1987.41
		90"(2286mm)	ULVL-1590-SISLN	1785.66	1911.83	UXVL-1590-SISXN	2030.98	2039.16
		96"(2438mm)	ULVL-1596-SISLN	1824.69	1959.04	UXVL-1596-SISXN	2079.09	2087.78
		102"(2591mm)	ULVL-15A2-SISLN	1866.87	2007.44	UXVL-15A2-SISXN	2130.33	2139.53
		108"(2743mm)	ULVL-15A8-SISLN	1905.90	2054.66	UXVL-15A8-SISXN	2178.44	2188.15
114"(2896mm)	ULVL-15B4-SISLN	1948.07	2103.04	UXVL-15B4-SISXN	2229.68	2239.91		
120"(3048mm)	ULVL-15C0-SISLN	1987.09	2150.26	UXVL-15C0-SISXN	2277.78	2288.52		
27"(686mm)	14"(356mm)	30"(762mm)	ULVL-2730-S2SLN	\$ 1429.65	\$ 1522.52	UXVL-2730-S2SXN	\$ 1797.11	\$ 1802.34
		36"(914mm)	ULVL-2736-S2SLN	1510.20	1617.17	UXVL-2736-S2SXN	1891.49	1897.59
		42"(1067mm)	ULVL-2742-S2SLN	1633.06	1750.22	UXVL-2742-S2SXN	2028.18	2035.15
		48"(1219mm)	ULVL-2748-S2SLN	1707.28	1838.55	UXVL-2748-S2SXN	2116.24	2124.09
		54"(1372mm)	ULVL-2754-S2SLN	1787.83	1929.30	UXVL-2754-S2SXN	2210.62	2219.34
		60"(1524mm)	ULVL-2760-S2SLN	1921.49	2077.07	UXVL-2760-S2SXN	2358.13	2367.72
		66"(1676mm)	ULVL-2766-S2SLN	1995.72	2161.50	UXVL-2766-S2SXN	2446.19	2456.66
		72"(1829mm)	ULVL-2772-S2SLN	2076.27	2256.15	UXVL-2772-S2SXN	2540.57	2551.91
		78"(1981mm)	ULVL-2778-S2SLN	2183.60	2373.68	UXVL-2778-S2SXN	2661.74	2673.95
		84"(2134mm)	ULVL-2784-S2SLN	2416.91	2621.10	UXVL-2784-S2SXN	2908.88	2921.96
		90"(2286mm)	ULVL-2790-S2SLN	2497.45	2711.84	UXVL-2790-S2SXN	3003.26	3017.22
		96"(2438mm)	ULVL-2796-S2SLN	2571.67	2800.17	UXVL-2796-S2SXN	3091.32	3106.15
		102"(2591mm)	ULVL-27A2-S2SLN	2652.22	2890.91	UXVL-27A2-S2SXN	3185.70	3201.40
		108"(2743mm)	ULVL-27A8-S2SLN	2726.45	2979.24	UXVL-27A8-S2SXN	3273.76	3290.33
114"(2896mm)	ULVL-27B4-S2SLN	2806.99	3069.99	UXVL-27B4-S2SXN	3368.14	3385.59		
120"(3048mm)	ULVL-27C0-S2SLN	2881.22	3158.33	UXVL-27C0-S2SXN	3456.20	3474.52		

Wall Mount L Shelf

Nominal Height	Nominal Depth	Nominal Width	HPL Number	HPL A	HPL B	Wood Number	Wood A	Wood B
Legal Depth								
14"(356mm)	16.5"(419mm)	30"(762mm)	ULVD-1430-S1ALN	\$ 1104.66	\$ 1162.17	UXVD-1430-S1AXN	\$ 1248.19	\$ 1251.07
		36"(914mm)	ULVD-1436-S1ALN	1149.51	1213.54	UXVD-1436-S1AXN	1300.13	1303.50
		42"(1067mm)	ULVD-1442-S1ALN	1236.65	1309.18	UXVD-1442-S1AXN	1394.39	1398.23
		48"(1219mm)	ULVD-1448-S1ALN	1278.35	1357.41	UXVD-1448-S1AXN	1443.17	1447.50
		54"(1372mm)	ULVD-1454-S1ALN	1323.19	1410.74	UXVD-1454-S1AXN	1495.11	1499.93
		60"(1524mm)	ULVD-1460-S1ALN	1421.16	1515.24	UXVD-1460-S1AXN	1600.19	1605.48
		66"(1676mm)	ULVD-1466-S1ALN	1462.85	1565.41	UXVD-1466-S1AXN	1648.97	1654.75
		72"(1829mm)	ULVD-1472-S1ALN	1507.69	1616.79	UXVD-1472-S1AXN	1700.92	1707.17
		78"(1981mm)	ULVD-1478-S1ALN	1579.33	1696.91	UXVD-1478-S1AXN	1779.65	1786.39
		84"(2134mm)	ULVD-1484-S1ALN	1780.10	1904.21	UXVD-1484-S1AXN	1987.52	1994.74
		90"(2286mm)	ULVD-1490-S1ALN	1824.93	1957.53	UXVD-1490-S1AXN	2039.46	2047.16
		96"(2438mm)	ULVD-1496-S1ALN	1866.62	2005.75	UXVD-1496-S1AXN	2088.25	2096.43
		102"(2591mm)	ULVD-14A2-S1ALN	1911.46	2059.09	UXVD-14A2-S1AXN	2140.19	2148.85
		108"(2743mm)	ULVD-14A8-S1ALN	1953.15	2107.30	UXVD-14A8-S1AXN	2188.98	2198.12
114"(2896mm)	ULVD-14B4-S1ALN	1998.00	2160.64	UXVD-14B4-S1AXN	2240.92	2250.55		
120"(3048mm)	ULVD-14C0-S1ALN	2039.67	2208.84	UXVD-14C0-S1AXN	2289.71	2299.81		
15"(381mm)	16.5"(419mm)	30"(762mm)	ULVD-1530-S1SLN	\$ 1112.58	\$ 1170.96	UXVD-1530-S1SXX	\$ 1261.09	\$ 1264.15
		36"(914mm)	ULVD-1536-S1SLN	1158.77	1223.82	UXVD-1536-S1SXX	1315.24	1318.82
		42"(1067mm)	ULVD-1542-S1SLN	1247.25	1320.95	UXVD-1542-S1SXX	1411.70	1415.79
		48"(1219mm)	ULVD-1548-S1SLN	1290.27	1370.65	UXVD-1548-S1SXX	1462.69	1467.29
		54"(1372mm)	ULVD-1554-S1SLN	1336.45	1425.47	UXVD-1554-S1SXX	1516.84	1521.95
		60"(1524mm)	ULVD-1560-S1SLN	1435.75	1531.45	UXVD-1560-S1SXX	1624.12	1629.74
		66"(1676mm)	ULVD-1566-S1SLN	1478.76	1583.11	UXVD-1566-S1SXX	1675.10	1681.24
		72"(1829mm)	ULVD-1572-S1SLN	1524.96	1635.98	UXVD-1572-S1SXX	1729.26	1735.90
		78"(1981mm)	ULVD-1578-S1SLN	1597.91	1717.58	UXVD-1578-S1SXX	1810.19	1817.35
		84"(2134mm)	ULVD-1584-S1SLN	1800.01	1926.36	UXVD-1584-S1SXX	2020.27	2027.94
		90"(2286mm)	ULVD-1590-S1SLN	1846.17	1981.17	UXVD-1590-S1SXX	2074.41	2082.59
		96"(2438mm)	ULVD-1596-S1SLN	1889.20	2030.88	UXVD-1596-S1SXX	2125.41	2134.10
		102"(2591mm)	ULVD-15A2-S1SLN	1935.38	2085.70	UXVD-15A2-S1SXX	2179.55	2188.75
		108"(2743mm)	ULVD-15A8-S1SLN	1978.39	2135.40	UXVD-15A8-S1SXX	2230.55	2240.26
114"(2896mm)	ULVD-15B4-S1SLN	2024.57	2190.21	UXVD-15B4-S1SXX	2284.69	2294.92		
120"(3048mm)	ULVD-15C0-S1SLN	2067.58	2239.91	UXVD-15C0-S1SXX	2335.68	2346.42		
27"(686mm)	16.5"(419mm)	30"(762mm)	ULVD-2730-S2SLN	\$ 1470.77	\$ 1572.12	UXVD-2730-S2SXX	\$ 1826.06	\$ 1831.29
		36"(914mm)	ULVD-2736-S2SLN	1559.30	1671.77	UXVD-2736-S2SXX	1926.23	1932.33
		42"(1067mm)	ULVD-2742-S2SLN	1690.15	1817.63	UXVD-2742-S2SXX	2068.71	2075.68
		48"(1219mm)	ULVD-2748-S2SLN	1772.36	1910.96	UXVD-2748-S2SXX	2162.56	2170.41
		54"(1372mm)	ULVD-2754-S2SLN	1860.90	2014.52	UXVD-2754-S2SXX	2262.73	2271.45
		60"(1524mm)	ULVD-2760-S2SLN	2002.57	2167.31	UXVD-2760-S2SXX	2416.03	2425.62
		66"(1676mm)	ULVD-2766-S2SLN	2084.78	2264.54	UXVD-2766-S2SXX	2509.88	2520.35
		72"(1829mm)	ULVD-2772-S2SLN	2173.32	2364.20	UXVD-2772-S2SXX	2610.05	2621.39
		78"(1981mm)	ULVD-2778-S2SLN	2288.63	2494.54	UXVD-2778-S2SXX	2737.01	2749.22
		84"(2134mm)	ULVD-2784-S2SLN	2529.93	2746.96	UXVD-2784-S2SXX	2989.94	3003.02
		90"(2286mm)	ULVD-2790-S2SLN	2618.47	2850.52	UXVD-2790-S2SXX	3090.11	3104.07
		96"(2438mm)	ULVD-2796-S2SLN	2700.68	2943.85	UXVD-2796-S2SXX	3183.96	3198.79
		102"(2591mm)	ULVD-27A2-S2SLN	2789.22	3047.40	UXVD-27A2-S2SXX	3284.13	3299.83
		108"(2743mm)	ULVD-27A8-S2SLN	2871.44	3140.74	UXVD-27A8-S2SXX	3377.98	3394.55
114"(2896mm)	ULVD-27B4-S2SLN	2959.98	3244.30	UXVD-27B4-S2SXX	3478.15	3495.60		
120"(3048mm)	ULVD-27C0-S2SLN	3042.19	3337.64	UXVD-27C0-S2SXX	3572.00	3590.32		

Wall Mount Floating Metal Shelf

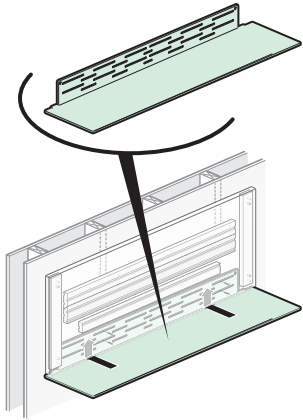

UMW8
UMWX
UMWL
UMWD
Class RA

Features

- Includes one metal shelf.
- Shelf is available in 8”(203mm) or 10”(254mm) accessory shelf depth, letter and legal depth.
- Ships assembled.

Specification Tips

- Designed to be use with:
 - Wall Mount Tile Kits
 - Above 2H storage
 - Tackboard (KUAF-XXXX)
- Mounts on structural building wall. 30”(762mm)W cannot be mounted on 24”(610mm) commercial stud spacing. Metal shelf needs to attach to two studs.
- Must be properly anchored to structural building wall with field supplied anchors.
- Letter (14”(356mm)) or legal (16.5”(419mm))D can be used for binder storage.
- Cannot mount lower than 38”(965mm) off floor.
- Do not install upside down.
- Use separately specified Vertical Filler Trim to conceal installation details and provide a clean finish. Vertical Filler Trim adds .125”(3mm) to the overall width of the application.
- Tackboards can be used but are not recommended.
- Refer to Specification Guide for weight limitations and application information.

To Order, Specify:

- 1) Product number.
- 2) Trim color.

Application	Depth	Width	Number	Price
Accessory Shelf	8”(203mm)	30”(762mm)	UMW8-0030-NMN	\$ 773.08
		36”(914mm)	UMW8-0036-NMN	790.44
		42”(1067mm)	UMW8-0042-NMN	807.80
		48”(1219mm)	UMW8-0048-NMN	825.16
		54”(1372mm)	UMW8-0054-NMN	842.52
		60”(1524mm)	UMW8-0060-NMN	859.88
		66”(1676mm)	UMW8-0066-NMN	877.24
	10”(254mm)	72”(1829mm)	UMW8-0072-NMN	894.60
		30”(762mm)	UMWX-0030-NMN	\$ 794.78
		36”(914mm)	UMWX-0036-NMN	816.48
		42”(1067mm)	UMWX-0042-NMN	838.18
		48”(1219mm)	UMWX-0048-NMN	859.88
		54”(1372mm)	UMWX-0054-NMN	881.58
		60”(1524mm)	UMWX-0060-NMN	903.28
Letter	14”(356mm)	66”(1676mm)	UMWX-0066-NMN	924.98
		72”(1829mm)	UMWX-0072-NMN	946.68
		30”(762mm)	UMWL-0030-NMN	\$ 838.18
		36”(914mm)	UMWL-0036-NMN	868.56
		42”(1067mm)	UMWL-0042-NMN	898.94
		48”(1219mm)	UMWL-0048-NMN	929.32
		54”(1372mm)	UMWL-0054-NMN	959.70
Legal	16.5”(419mm)	60”(1524mm)	UMWL-0060-NMN	990.08
		66”(1676mm)	UMWL-0066-NMN	1020.46
		72”(1829mm)	UMWL-0072-NMN	1050.84
		30”(762mm)	UMWD-0030-NMN	\$ 865.31
		36”(914mm)	UMWD-0036-NMN	901.11
		42”(1067mm)	UMWD-0042-NMN	936.92
		48”(1219mm)	UMWD-0048-NMN	972.72
		54”(1372mm)	UMWD-0054-NMN	1008.53
		60”(1524mm)	UMWD-0060-NMN	1044.33
		66”(1676mm)	UMWD-0066-NMN	1080.14
		72”(1829mm)	UMWD-0072-NMN	1115.94

Wall Mount Tile Kit

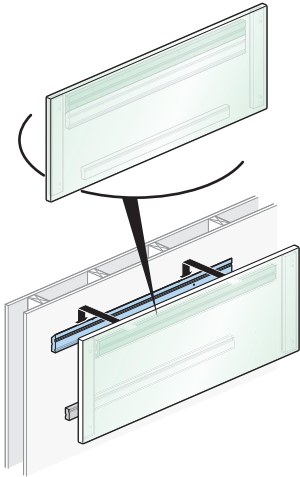

MZWK
Class RA

Features

- Include tile(s) with light block attached on each side, 4"(102mm)H french cleat with anti-dislodgement feature and attachment hardware.

Specification Tips

- Must be properly anchored to structural building wall with field supplied anchors.
- For use with Floating Metal Shelf (UMW_-----NMN) or alone as a full height tile.
- For use with 2H lower storage only.
- Product application options for below 1H, 1.5H or 2H upper storage components.
- Wood grain laminate grain switches direction to horizontal at 60"(1524mm)W. Recommend dividing into multiple pieces when you want to synchronize vertical grain.
- Refer to Product Details for alignment.
- Tile kits sit 1.5"(38mm) from the wall, requiring additional pinch point space for height adjustable convergent and credenza desks.
- Use separately specified Vertical Filler Trim to conceal installation details and provide a clean finish. Vertical Filler Trim adds 1/8" to the overall width of the application.

To Order, Specify:

- 1) Product number, including:

1 Number of Tiles 25"(635mm)H applications only:

- 1** One
- 2** Two

- 2) Laminate surface color or Wood finish color.
- 3) Edge trim color (laminare).

Wall Mount Tile Kit

Height	Width	Number of Tiles	HPL Number ①	HPL A	HPL B	Wood Number ①	Wood A	Wood B
19"(483mm)	30"(762mm)	1	MLWK-1930-M1	\$ 947.92	\$ 972.46	MZWK-1930-M1	\$ 1242.08	\$ 1299.87
	36"(914mm)	1	MLWK-1936-M1	983.50	1012.95	MZWK-1936-M1	1312.50	1381.85
	42"(1067mm)	1	MLWK-1942-M1	1019.08	1053.44	MZWK-1942-M1	1382.92	1463.82
	48"(1219mm)	1	MLWK-1948-M1	1054.67	1093.93	MZWK-1948-M1	1453.33	1545.80
	54"(1372mm)	1	MLWK-1954-M1	1090.25	1134.43	MZWK-1954-M1	1523.75	1627.77
	60"(1524mm)	1	MLWK-1960-M1	1125.83	1174.92	MZWK-1960-M1	1594.17	1709.75
	66"(1676mm)	1	MLWK-1966-M1	1161.42	1215.41	MZWK-1966-M1	1664.58	1791.73
	72"(1829mm)	1	MLWK-1972-M1	1197.00	1255.90	MZWK-1972-M1	1735.00	1873.70
23"(584mm)	30"(762mm)	1	MLWK-2330-M1	\$ 979.58	\$ 1009.29	MZWK-2330-M1	\$ 1310.42	\$ 1380.37
	36"(914mm)	1	MLWK-2336-M1	1021.50	1057.15	MZWK-2336-M1	1394.50	1478.45
	42"(1067mm)	1	MLWK-2342-M1	1063.42	1105.01	MZWK-2342-M1	1478.58	1576.52
	48"(1219mm)	1	MLWK-2348-M1	1105.33	1152.87	MZWK-2348-M1	1562.67	1674.60
	54"(1372mm)	1	MLWK-2354-M1	1147.25	1200.72	MZWK-2354-M1	1646.75	1772.67
	60"(1524mm)	1	MLWK-2360-M1	1189.17	1248.58	MZWK-2360-M1	1730.83	1870.75
	66"(1676mm)	1	MLWK-2366-M1	1231.08	1296.44	MZWK-2366-M1	1814.92	1968.83
	72"(1829mm)	1	MLWK-2372-M1	1273.00	1344.30	MZWK-2372-M1	1899.00	2066.90
25"(635mm)	30"(762mm)	1 or 2	MLWK-2530-M	\$ 995.42	\$ 1027.71	MZWK-2530-M	\$ 1344.58	\$ 1420.62
	36"(914mm)	1 or 2	MLWK-2536-M	1040.50	1079.25	MZWK-2536-M	1435.50	1526.75
	42"(1067mm)	1 or 2	MLWK-2542-M	1085.58	1130.79	MZWK-2542-M	1526.42	1632.87
	48"(1219mm)	1 or 2	MLWK-2548-M	1130.67	1182.33	MZWK-2548-M	1617.33	1739.00
	54"(1372mm)	1 or 2	MLWK-2554-M	1175.75	1233.88	MZWK-2554-M	1708.25	1845.13
	60"(1524mm)	1 or 2	MLWK-2560-M	1220.83	1285.42	MZWK-2560-M	1799.17	1951.25
	66"(1676mm)	1 or 2	MLWK-2566-M	1265.92	1336.96	MZWK-2566-M	1890.08	2057.37
	72"(1829mm)	1 or 2	MLWK-2572-M	1311.00	1388.50	MZWK-2572-M	1981.00	2163.50
36"(914mm)	30"(762mm)	3	MLWK-3630-M3	\$ 1822.50	\$ 1903.50	MZWK-3630-M3	\$ 2302.50	\$ 2449.50
	36"(914mm)	3	MLWK-3636-M3	1927.00	2024.20	MZWK-3636-M3	2473.00	2649.40
	42"(1067mm)	3	MLWK-3642-M3	2031.50	2144.90	MZWK-3642-M3	2643.50	2849.30
	48"(1219mm)	3	MLWK-3648-M3	2136.00	2265.60	MZWK-3648-M3	2814.00	3049.20
	54"(1372mm)	3	MLWK-3654-M3	2240.50	2386.30	MZWK-3654-M3	2984.50	3249.10
	60"(1524mm)	3	MLWK-3660-M3	2345.00	2507.00	MZWK-3660-M3	3155.00	3449.00
	66"(1676mm)	3	MLWK-3666-M3	2449.50	2627.70	MZWK-3666-M3	3325.50	3648.90
	72"(1829mm)	3	MLWK-3672-M3	2554.00	2748.40	MZWK-3672-M3	3496.00	3848.80
38"(965mm)	30"(762mm)	3	MLWK-3830-M3	\$ 1850.00	\$ 1935.50	MZWK-3830-M3	\$ 2348.34	\$ 2503.50
	36"(914mm)	3	MLWK-3836-M3	1960.00	2062.60	MZWK-3836-M3	2528.00	2714.20
	42"(1067mm)	3	MLWK-3842-M3	2070.00	2189.70	MZWK-3842-M3	2707.66	2924.90
	48"(1219mm)	3	MLWK-3848-M3	2180.00	2316.80	MZWK-3848-M3	2887.34	3135.60
	54"(1372mm)	3	MLWK-3854-M3	2290.00	2443.90	MZWK-3854-M3	3067.00	3346.30
	60"(1524mm)	3	MLWK-3860-M3	2400.00	2571.00	MZWK-3860-M3	3246.66	3557.00
	66"(1676mm)	3	MLWK-3866-M3	2510.00	2698.10	MZWK-3866-M3	3426.34	3767.70
	72"(1829mm)	3	MLWK-3872-M3	2620.00	2825.20	MZWK-3872-M3	3606.00	3978.40

Wall Mount Tile Kit

Height	Width	Number of Tiles	HPL Number ①	HPL A	HPL B	Wood Number ①	Wood A	Wood B
39"(991mm)	30"(762mm)	3	MLWK-3930-M3	\$ 1863.75	\$ 1951.51	MZWK-3930-M3	\$ 2371.25	\$ 2530.51
	36"(914mm)	3	MLWK-3936-M3	1976.50	2081.80	MZWK-3936-M3	2555.50	2746.60
	42"(1067mm)	3	MLWK-3942-M3	2089.25	2212.10	MZWK-3942-M3	2739.75	2962.71
	48"(1219mm)	3	MLWK-3948-M3	2202.00	2342.40	MZWK-3948-M3	2924.00	3178.80
	54"(1372mm)	3	MLWK-3954-M3	2314.75	2472.69	MZWK-3954-M3	3108.25	3394.89
	60"(1524mm)	3	MLWK-3960-M3	2427.50	2603.00	MZWK-3960-M3	3292.50	3611.00
	66"(1676mm)	3	MLWK-3966-M3	2540.25	2733.31	MZWK-3966-M3	3476.75	3827.10
	72"(1829mm)	3	MLWK-3972-M3	2653.00	2863.60	MZWK-3972-M3	3661.00	4043.20
40"(1016mm)	30"(762mm)	3	MLWK-4030-M3	\$ 1877.50	\$ 1967.50	MZWK-4030-M3	\$ 2394.16	\$ 2557.50
	36"(914mm)	3	MLWK-4036-M3	1993.00	2101.00	MZWK-4036-M3	2583.00	2779.00
	42"(1067mm)	3	MLWK-4042-M3	2108.50	2234.50	MZWK-4042-M3	2771.84	3000.50
	48"(1219mm)	3	MLWK-4048-M3	2224.00	2368.00	MZWK-4048-M3	2960.66	3222.00
	54"(1372mm)	3	MLWK-4054-M3	2339.50	2501.50	MZWK-4054-M3	3149.50	3443.50
	60"(1524mm)	3	MLWK-4060-M3	2455.00	2635.00	MZWK-4060-M3	3338.34	3665.00
	66"(1676mm)	3	MLWK-4066-M3	2570.50	2768.50	MZWK-4066-M3	3527.16	3886.50
	72"(1829mm)	3	MLWK-4072-M3	2686.00	2902.00	MZWK-4072-M3	3716.00	4108.00
52"(1321mm)	30"(762mm)	4	MLWK-5230-M4	\$ 2364.17	\$ 2505.86	MZWK-5230-M4	\$ 2960.83	\$ 3201.33
	36"(914mm)	4	MLWK-5236-M4	2543.00	2713.04	MZWK-5236-M4	3235.00	3523.60
	42"(1067mm)	4	MLWK-5242-M4	2721.83	2920.22	MZWK-5242-M4	3509.17	3845.87
	48"(1219mm)	4	MLWK-5248-M4	2900.67	3127.38	MZWK-5248-M4	3783.33	4168.13
	54"(1372mm)	4	MLWK-5254-M4	3079.50	3334.56	MZWK-5254-M4	4057.50	4490.40
	60"(1524mm)	4	MLWK-5260-M4	3258.33	3541.74	MZWK-5260-M4	4331.67	4812.67
	66"(1676mm)	4	MLWK-5266-M4	3437.17	3748.90	MZWK-5266-M4	4605.83	5134.93
	72"(1829mm)	4	MLWK-5272-M4	3616.00	3956.08	MZWK-5272-M4	4880.00	5457.20

Wall Mount Frameless Glass Tile

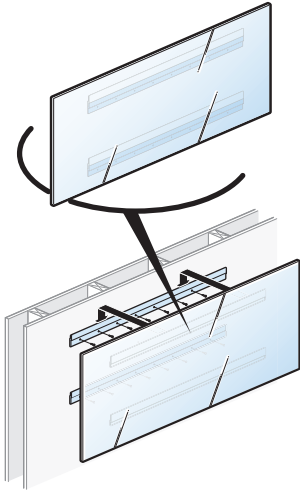

UGWT
Class RA

Features

- Includes one, dubbed corner, non-magnetic frameless glass tile with attachment brackets.
- Ships assembled.

Specification Tips

- Measurements accommodate a .25"(6mm) gap in overall height.
- Not for use with VSUs or Floating Metal Shelf.
- Must be properly anchored to structural building wall with field supplied anchors.
- Use separately specified Vertical Filler Trim to conceal installation details and provide a clean finish. Vertical Filler Trim adds .125"(3mm) to the overall width of the application.
- Paint markers are recommended for black backpainted glass and are sourced locally.
- Dry erase marker kit (includes holer, six markers and eraser), order part# 7062-8001 is recommended for white backpainted glass.

To Order, Specify:

- 1) Product number.
- 2) Glass option.
3G-BL6 White
3G-BL7 Black

Height	Width	Number	Price
19"(483mm)	30"(762mm)	UGWT-1930-N	\$ 1287.39
	36"(914mm)	UGWT-1936-N	1641.93
	42"(1067mm)	UGWT-1942-N	1886.22
	48"(1219mm)	UGWT-1948-N	2130.51
	54"(1372mm)	UGWT-1954-N	2521.80
	60"(1524mm)	UGWT-1960-N	2766.09
	66"(1676mm)	UGWT-1966-N	3010.38
23"(584mm)	72"(1829mm)	UGWT-1972-N	3254.67
	30"(762mm)	UGWT-2330-N	\$ 1401.72
	36"(914mm)	UGWT-2336-N	1778.31
	42"(1067mm)	UGWT-2342-N	2044.65
	48"(1219mm)	UGWT-2348-N	2310.99
	54"(1372mm)	UGWT-2354-N	2724.33
	60"(1524mm)	UGWT-2360-N	2990.67
25"(635mm)	66"(1676mm)	UGWT-2366-N	3257.01
	72"(1829mm)	UGWT-2372-N	3523.35
	30"(762mm)	UGWT-2530-N	\$ 1458.89
	36"(914mm)	UGWT-2536-N	1846.50
	42"(1067mm)	UGWT-2542-N	2123.87
	48"(1219mm)	UGWT-2548-N	2401.23
	54"(1372mm)	UGWT-2554-N	2825.60
32"(813mm)	60"(1524mm)	UGWT-2560-N	3102.96
	66"(1676mm)	UGWT-2566-N	3380.33
	72"(1829mm)	UGWT-2572-N	3657.69
	30"(762mm)	UGWT-3230-N	\$ 1630.38
	36"(914mm)	UGWT-3236-N	2051.07
	42"(1067mm)	UGWT-3242-N	2361.51
	48"(1219mm)	UGWT-3248-N	2671.95
32"(813mm)	54"(1372mm)	UGWT-3254-N	3129.39
	60"(1524mm)	UGWT-3260-N	3439.83
	66"(1676mm)	UGWT-3266-N	3750.27
	72"(1829mm)	UGWT-3272-N	4060.71

Wall Mount Frameless Glass Tile

Height	Width	Number	Price
36"(914mm)	30"(762mm)	UGWT-3630-N	\$ 1854.96
	36"(914mm)	UGWT-3636-N	2187.45
	42"(1067mm)	UGWT-3642-N	2519.94
	48"(1219mm)	UGWT-3648-N	2852.43
	54"(1372mm)	UGWT-3654-N	3331.92
	60"(1524mm)	UGWT-3660-N	3664.41
	66"(1676mm)	UGWT-3666-N	3996.90
	72"(1829mm)	UGWT-3672-N	4329.39
38"(965mm)	30"(762mm)	UGWT-3830-N	\$ 1912.13
	36"(914mm)	UGWT-3836-N	2255.64
	42"(1067mm)	UGWT-3842-N	2599.16
	48"(1219mm)	UGWT-3848-N	2942.67
	54"(1372mm)	UGWT-3854-N	3433.19
	60"(1524mm)	UGWT-3860-N	3776.70
	66"(1676mm)	UGWT-3866-N	4120.22
	72"(1829mm)	UGWT-3872-N	4463.73
39"(991mm)	30"(762mm)	UGWT-3930-N	\$ 1969.29
	36"(914mm)	UGWT-3936-N	2323.83
	42"(1067mm)	UGWT-3942-N	2678.37
	48"(1219mm)	UGWT-3948-N	3032.91
	54"(1372mm)	UGWT-3954-N	3534.45
	60"(1524mm)	UGWT-3960-N	3888.99
	66"(1676mm)	UGWT-3966-N	4243.53
	72"(1829mm)	UGWT-3972-N	4598.07
40"(1016mm)	30"(762mm)	UGWT-4030-N	\$ 1969.29
	36"(914mm)	UGWT-4036-N	2323.83
	42"(1067mm)	UGWT-4042-N	2678.37
	48"(1219mm)	UGWT-4048-N	3032.91
	54"(1372mm)	UGWT-4054-N	3534.45
	60"(1524mm)	UGWT-4060-N	3888.99
	66"(1676mm)	UGWT-4066-N	4243.53
	72"(1829mm)	UGWT-4072-N	4598.07
52"(1321mm)	30"(762mm)	UGWT-5230-N	\$ 2516.45
	36"(914mm)	UGWT-5236-N	2948.16
	42"(1067mm)	UGWT-5242-N	3379.88
	48"(1219mm)	UGWT-5248-N	3811.59
	54"(1372mm)	UGWT-5254-N	4243.31
	60"(1524mm)	UGWT-5260-N	4675.02
	66"(1676mm)	UGWT-5266-N	5106.74
	72"(1829mm)	UGWT-5272-N	5538.45

Wall Mount Tackboard

For Overhead Storage Units

Fabric

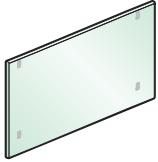

30"-60" widths

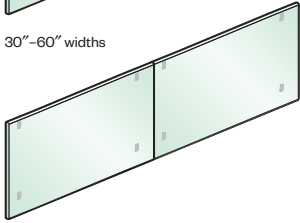

66"-96" widths

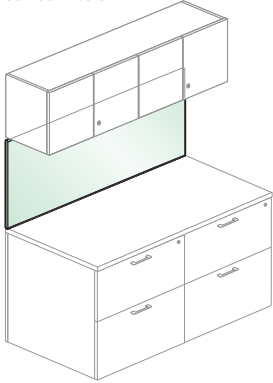

MTWD
Class RA

Feature

- Tackboards over 60"(1524mm)W include two fabric sections.

Specification Tips

- Designed to mount on wall below equal width overhead storage unit or an open sided shelf.
- Not for use with overhead storage units with cubbies.

To Order, Specify:

- 1) Product number.
- 2) Fabric code.

Height	Width	Number	Fabric		
			A	B	C
18"(457mm)	30"(762mm)	MTWD-1830	\$340.68	\$390.13	\$451.50
	36"(914mm)	MTWD-1836	366.66	419.71	486.00
	42"(1067mm)	MTWD-1842	392.64	449.29	520.50
	48"(1219mm)	MTWD-1848	418.62	478.87	555.00
	54"(1372mm)	MTWD-1854	444.60	508.45	589.50
	60"(1524mm)	MTWD-1860	470.58	538.03	624.00
	66"(1676mm)	MTWD-1866	496.56	567.61	658.50
	72"(1829mm)	MTWD-1872	522.54	597.19	693.00
	78"(1981mm)	MTWD-1878	669.32	884.25	1024.74
	84"(2134mm)	MTWD-1884	707.48	936.87	1086.00
	90"(2286mm)	MTWD-1890	745.64	989.49	1147.26
22"(559mm)	96"(2438mm)	MTWD-1896	783.80	1042.11	1208.52
	30"(762mm)	MTWD-2230	\$393.40	\$450.37	\$521.50
	36"(914mm)	MTWD-2236	419.86	480.43	556.72
	42"(1067mm)	MTWD-2242	446.32	510.49	591.94
	48"(1219mm)	MTWD-2248	472.78	540.55	627.16
	54"(1372mm)	MTWD-2254	499.24	570.61	662.38
	60"(1524mm)	MTWD-2260	525.70	600.67	697.60
	66"(1676mm)	MTWD-2266	648.20	864.53	1001.50
	72"(1829mm)	MTWD-2272	690.92	924.35	1071.16
	78"(1981mm)	MTWD-2278	733.64	984.17	1140.82
	84"(2134mm)	MTWD-2284	776.36	1043.99	1210.48
90"(2286mm)	MTWD-2290	819.08	1103.81	1280.14	
96"(2438mm)	MTWD-2296	861.80	1163.63	1349.80	

Wall Mount Tackboard

For Overhead Storage Units

Fabric and Slat Rail

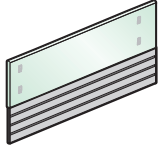

30"-60" widths

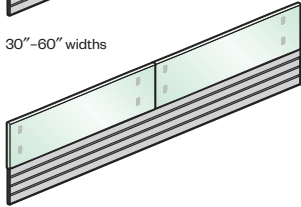

66"-96" widths

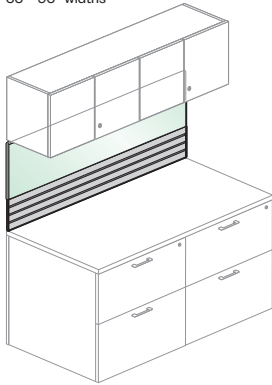

MTSW
Class RA

Features

- Includes fabric covered tackboard(s) with slat rail and attachment hardware.
- Tackboards over 60"(1524mm)W include two fabric sections. Optional slat rail is one full-width section.

Specification Tips

- Designed to mount on wall below equal width overhead storage unit or an open sided shelf.
- Slat rail accommodates separately specified Belong work tools.
- 22"(559mm)H not for use with overhead storage units with cubbies.

To Order, Specify:

- 1) Product number.
- 2) Fabric code.
- 3) Trim code for slat rail.

Height	Width	Number	Fabric		
			A	B	C
18"(457mm)	30"(762mm)	MTSW-1830	\$ 614.99	\$708.06	\$812.09
	36"(914mm)	MTSW-1836	658.80	758.42	869.90
	42"(1067mm)	MTSW-1842	702.61	808.78	927.71
	48"(1219mm)	MTSW-1848	746.42	859.14	985.52
	54"(1372mm)	MTSW-1854	790.23	909.50	1043.33
	60"(1524mm)	MTSW-1860	819.32	942.67	1082.16
	66"(1676mm)	MTSW-1866	905.08	1041.42	1195.30
	72"(1829mm)	MTSW-1872	990.84	1140.17	1308.44
	78"(1981mm)	MTSW-1878	1076.60	1238.92	1421.58
	84"(2134mm)	MTSW-1884	1162.36	1337.67	1534.72
22"(559mm)	90"(2286mm)	MTSW-1890	1248.12	1436.42	1647.86
	96"(2438mm)	MTSW-1896	1333.88	1535.17	1761.00
	30"(762mm)	MTSW-2230	\$ 622.30	\$716.46	\$821.78
	36"(914mm)	MTSW-2236	666.11	766.82	879.59
	42"(1067mm)	MTSW-2242	709.92	817.18	937.40
	48"(1219mm)	MTSW-2248	753.73	867.54	995.21
	54"(1372mm)	MTSW-2254	797.54	917.90	1053.02
	60"(1524mm)	MTSW-2260	833.93	959.47	1101.51
	66"(1676mm)	MTSW-2266	919.69	1058.22	1214.65
	72"(1829mm)	MTSW-2272	1005.45	1156.97	1327.79
78"(1981mm)	MTSW-2278	1091.21	1255.72	1440.93	
84"(2134mm)	MTSW-2284	1176.97	1354.47	1554.07	
90"(2286mm)	MTSW-2290	1262.73	1453.22	1667.21	
96"(2438mm)	MTSW-2296	1348.49	1551.97	1780.35	

Stretch and Pull Information

Introduction

Simple stretch and pull of tackboards are an important part of making the design process easier.

This capability will decrease the need for designers to engage Tailored Solutions for custom sized, wall mounted tackboards, in simple applications, and have list pricing and 3D Imagery immediately.

Units of Measurement

- Use either empirical or metric units to create the correct size in any application.
- Type "IN" after the number when using empirical measurement (example 47.2IN).
- Type the measurement only when using metric (example 900.3).
- Both measurements have one decimal location.
- Consider reducing the overall height of the tackboard by .25"(6mm) to allow for wire management of task lights and power modules during installation.
- Note, dimensions provided in the chart for Masters include .25"(6mm) Gap to allow for wire management.

Sizing

- This catalog code can be used to specify any Tackboard size subject to the current limitations.
 Minimum sizes:
 -Width = 8"(203mm)
 -Height = 5"(127mm)
 Maximum sizes:
 -Width = 96"(2438mm)
 -Height = 96"(2438mm)
- Rightway fabric applications = Maximum 48"(1219mm)W x 96"(2438mm)H.
- Railroad (fabric applications = 96"(2438mm)W x 48"(1219mm)H.
- For applications with sizes greater than those listed, please specify multiple tackboards.

CET/Canvas

1. Bring in a Stretch and Pull tackboard from the Haworth Workstation Accessories Extension tab in Canvas.
2. Modify the starting elevation of the tackboard, as well as the height and the width, via the green box.
3. If the tackboard turns red, it means that the directionality of the fabric needs to be switched.
- Reminder that 48"(1219mm)W x 96"(2438mm)H is the largest size available, limited by our core material that the fabric is applied to:
 Example: KUAF-XXXX,3A-31,508,1333.5 metric
 KUAF-XXXX,3A-31,31.5IN,51.8IN inches

SPEC 5

1. Option standard part number (KUAF-1648 for example).
2. Double click on "Option Code" box.
3. Add 2 lines to the "Edit Parts Options".
4. Height, then width, in millimeters or inches.
 - Type "IN" after the number when using empirical measurement (example 47.2IN).
 - Type the measurement only when using metric (example 900.3).
1. Make sure to start each line with a comma (,).
2. Change part number to (KUAF-XXXX).
3. Run the "Validation Tool" to confirm correct spec.

AutoCAD Specification

Bring in a tackboard that is closest to the size you need.

1. Bring in a 2D Symbol of the KUAF tackboard from the Compose Storage, Organization and Lights Catalog.
2. Make a copy of it and create a 3D.
3. Edit the 2D symbol in the Enhanced Attribute editor by double clicking on it.
4. Use that Enhanced Attribute Editor to change the part number to KUAF-XXXX,[FINISH],[HEIGHT],[WIDTH].
5. Edit the 3D symbol to the height and width required for the application if an Isometric View is required.

Tackboard Size Chart

For Use with Standard Wall Mount Storage Components

Lower Storage Storage Height	Alignment to Upper Piece of Wall Mounted Storage	Recommended Order Sizing/Canvas Tackboard Height Inches (in)	Tackboard Height Millimeters (mm)
1H Lower Storage	Up to bottom of 1H OSU mounted at 5H std alignment	35.6	904.4
	Up to bottom of 1H L shelf mounted at 5H std alignment	37.7	958.3
	Up to bottom of 1H L shelf mounted at 5H w/ 2H alignment	38.3	973.2
	Up to bottom of 1.5H OSU mounted at 5H	31.6	803.7
	Up to bottom of 2H OSS/OSU mounted at 5H std alignment	22.9	581.9
	Up to bottom of 2H L shelf mounted at 5H std alignment	25.1	637.7
	Up to bottom of 1H OSS/OSU mounted at 6H	48.3	1227.2
	Up to bottom of 1H L shelf mounted at 6H standard alignment	50.4	1281.1
	Up to bottom of 1H L shelf mounted at 6H aligned	51.0	1296.0
	Up to bottom of 1.5H OSU mounted at 6H	44.3	1125.5
	Up to bottom of 2H OSS mounted at 6H	35.6	904.7
	Up to bottom of 2H L shelf mounted at 6H	37.8	960.5
	Full height up to 5H (69"(1753mm) aff)	51.8	1316.9
	Full height up to 6H (81.63"(2073mm) aff)	64.9	1649.2
1.5H Lower Storage	Up to bottom of 1H L shelf mounted at 5H std alignment	29.3	743.3
	Up to bottom of 1H L shelf mounted at 5H w/ 2H alignment	31.4	797.3
	Up to bottom of 1.5H OSU mounted at 5H w/ 2H alignment	32.0	812.1
	Up to bottom of 1.5H OSU mounted at 5H	25.3	642.6
	Up to bottom of 1H L shelf mounted at 5H std alignment	31.4	797.3
	Up to bottom of 1H L shelf mounted at 5H - aligned	32.2	812.1
	Up to bottom of 2H L shelf mounted at 5H	19.0	476.6
	Up to bottom of 2H OSU/OSS mounted at 5H	16.6	420.8
	Up to bottom of 1H OSS/OSU mounted at 6H	42.0	1066.1
	Up to bottom of 1H L shelf mounted at 6H standard alignment	44.1	1120.1
	Up to bottom of 1H L shelf mounted at 6H aligned	44.7	1134.9
	Up to bottom of 1.5H OSU mounted at 6H	38.0	964.4
	Up to bottom of 2H OSS/OSU mounted at 6H	29.3	743.6
	Up to bottom of 2H L shelf mounted at 6H	31.5	799.4
Full height up to 5H (69"(1753mm) aff)	45.9	1166.3	
Full height up to 6H (81.63"(2073mm) aff)	58.6	1488.1	
2H Lower Storage	Up to bottom of 1H OSS/OSU mounted at 5H std alignment	23.0	583.3
	Up to bottom of 1H L shelf mounted at 5H std alignment	25.1	637.2
	Up to bottom of 1.5H OSU mounted at 5H	18.9	480.1
	Up to bottom of 2H OSS/OSU mounted at 5H std alignment	25.1	637.2
	Up to bottom of 2H L shelf mounted at 5H std alignment	12.6	314.2
	Up to bottom of 1H OSS/OSU mounted at 6H	35.6	903.4
	Up to bottom of 1H L shelf mounted at 6H standard alignment	37.7	957.3
	Up to bottom of 1H L shelf mounted at 6H aligned (added)	38.3	971.8
	Up to bottom of 1.5H OSU mounted at 6H	31.6	805.6
	Up to bottom of 2H OSS/OSU mounted at 6H	23.0	583.3
	Up to bottom of 2H L shelf mounted at 6H	25.1	637.2
	Full height up to 5H (69"(1753mm) aff)	39.6	1006.3
	Full height up to 6H (81.63"(2073mm) aff)	52.2	1326.4
	Full Height to Lower Storage	Floor to top of 5H storage	69.0
Floor to top of 6H storage		81.6	2073.4
Reception Tackboard	Reception Station L-Shaped and U-Shaped	12.5	318.0

Wall Mount Spacers

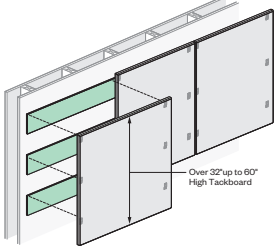
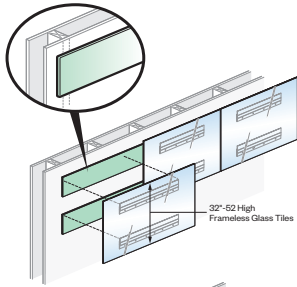

XLST
Class RA

Features

- Includes horizontal spacer(s).
- Edgeband color is Linen HP-WL applied to all sides.
- Standard edgeband color is Linen HP-WL.
- The front and back faces have a balanced core construction.
- Cut to size in the field.

Specification Tips

- Must be properly anchored to structural building wall with field supplied anchors.
- Spacers are designed to align the front face of one wall mounted component to the front face of another tile, tackboard or wall mounted shelf.
- Field modified to fit the width of the application. Cut side will lose the edgeband.
- Spacers can accommodate multiple tackboards or glass tiles up to 96"(2438mm)W.
- Use separately specified Vertical Filler Trim to conceal installation details and provide a clean finish. Vertical Filler Trim adds 1/8" to the overall width of the application.
- Height and application type will determine the number of pieces needed:
 - Two Pieces: All standard Frameless Glass Tile
Tackboards/Slat Rail 18"H
Tackboards 32"H or less
 - Three Pieces:
Tackboards/Slat Rail 22"
Tackboards Over 32"H up to 60"H
 - Four Pieces:
Tackboards Over 60"H up to 96"H

To Order, Specify:

- 1) Product number.
(No finish specification required)

Application Options	Height	Width	Thickness	Number of Pieces Included	Number	Price
Frameless Glass Tile to Tackboard or Tackboard to Open Sided Shelf or Tackboard to L Shelf or Tackboard to Wall Mount Tile Kit	6"(152mm)	95"(2413mm)	.371"(9mm)	2	XLST-0695-2A	\$407.00
				3	XLST-0695-3A	610.50
				4	XLST-0695-4A	814.00
Frameless Glass Tile to Open Sided Shelf or Frameless Glass Tile to L Shelf or Frameless Glass Tile to Wall Mount Tile Kit	7"(178mm)	95"(2413mm)	1.056"(27mm)	2	XLST-0695-2B	\$407.00
				3	XLST-0695-3B	610.50
				4	XLST-0695-4B	814.00

Wall Mount Vertical Filler Trim

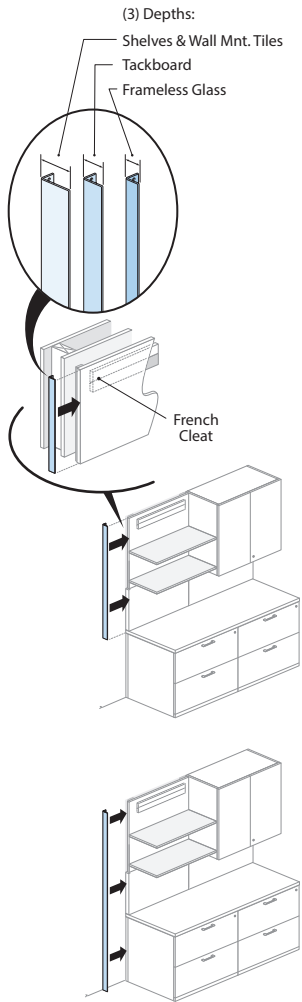

Features

- Includes one Vertical Filler Trim with attachment hardware.
- Cut to size in field.

Specification Tips

- Designed as an aesthetic end cap for mixed wall storage configurations, spacers ensure a seamless look when used with glass tiles, tackboards, open sided shelves, or L shelf back panels.
- Align multiple components based on the deepest unit for a consistent look.
- Use separately specified Vertical Filler Trim to conceal installation details and provide a clean finish. Vertical Filler Trim adds 1/8" to the overall width of the application.

To Order, Specify:

- 1) Product number.
- 2) Trim color.

Application	Height	Depth	Number	Price
Frameless Glass Tiles without spacer	81"(2057mm)	.5"(13mm)	XMFT-8100-1	\$159.00
Tackboard without spacers for Frameless Glass Tiles with 3/8" spacer		1"(28mm)	XMFT-8100-2	159.00
L Shelf, Wall Mounted Tile, Tackboard with 3/8" spacer or Frameless Glass Tiles 1.5"(38mm)Tile with 1.1" spacer		1.5"(38mm)	XMFT-8100-3	159.00

XMFT-8100
Class RA

Overhead Storage Unit

1H Open

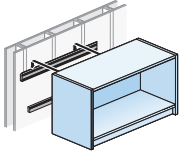

30" and 36" widths

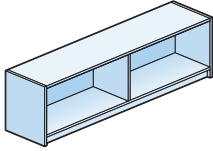

42"-72" widths

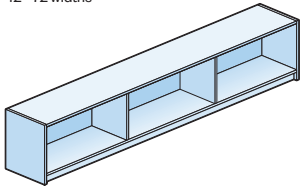

78"-96" widths
ULNL-SN
ULND-SN
UXNL-SN
UXND-SN
Class RA

Features

- Includes storage cabinet(s) with 2" (51mm) integrated light valance and 4" (102mm) French cleat with anti-dislodgement feature.
- Shipped assembled.

Specification Tips

- Accommodates separately specified tackboards and lighting accessories.
- Must be properly anchored to a structural wall.
- Anchors are not provided, must be field supplied.

To Order, Specify:

- 1) Product number.
- 2) Finish code (laminite or wood).
- 3) Laminate edge trim color (if laminate specified).

Overhead Storage Unit

1H Open

Height	Depth	Width	Number	HPL	
				A	B
HPL — Letter Depth					
16.56"(421mm)	14"(356mm)	30"(762mm)	ULNL-1730-NSN	\$ 1126.00	\$ 1188.55
	14"(356mm)	36"(914mm)	ULNL-1736-NSN	1243.29	1315.21
	14"(356mm)	42"(1067mm)	ULNL-1742-NSN	1377.79	1459.08
	14"(356mm)	48"(1219mm)	ULNL-1748-NSN	1495.08	1585.74
	14"(356mm)	54"(1372mm)	ULNL-1754-NSN	1612.37	1712.40
	14"(356mm)	60"(1524mm)	ULNL-1760-NSN	1729.66	1839.06
	14"(356mm)	66"(1676mm)	ULNL-1766-NSN	1846.95	1965.72
	14"(356mm)	72"(1829mm)	ULNL-1772-NSN	1964.24	2092.38
	14"(356mm)	78"(1981mm)	ULNL-1778-NSN	2098.74	2236.25
	14"(356mm)	84"(2134mm)	ULNL-1784-NSN	2216.03	2362.91
	14"(356mm)	90"(2286mm)	ULNL-1790-NSN	2333.32	2489.57
	14"(356mm)	96"(2438mm)	ULNL-1796-NSN	2450.61	2616.23

HPL — Legal Depth					
16.56"(421mm)	16.5"(419mm)	30"(762mm)	ULND-1730-NSN	\$ 1282.38	\$ 1357.43
	16.5"(419mm)	36"(914mm)	ULND-1736-NSN	1399.67	1484.09
	16.5"(419mm)	42"(1067mm)	ULND-1742-NSN	1534.17	1627.96
	16.5"(419mm)	48"(1219mm)	ULND-1748-NSN	1651.46	1754.62
	16.5"(419mm)	54"(1372mm)	ULND-1754-NSN	1768.75	1881.28
	16.5"(419mm)	60"(1524mm)	ULND-1760-NSN	1886.04	2007.94
	16.5"(419mm)	66"(1676mm)	ULND-1766-NSN	2003.33	2134.60
	16.5"(419mm)	72"(1829mm)	ULND-1772-NSN	2120.62	2261.26
	16.5"(419mm)	78"(1981mm)	ULND-1778-NSN	2255.12	2405.13
	16.5"(419mm)	84"(2134mm)	ULND-1784-NSN	2372.41	2531.79
	16.5"(419mm)	90"(2286mm)	ULND-1790-NSN	2489.70	2658.45
	16.5"(419mm)	96"(2438mm)	ULND-1796-NSN	2606.99	2785.11

Height	Depth	Width	Number	Wood	
				A	B
Wood — Letter Depth					
16.56"(421mm)	14"(356mm)	30"(762mm)	UXNL-1730-NSN	\$ 1896.81	\$ 2112.64
	14"(356mm)	36"(914mm)	UXNL-1736-NSN	2113.70	2351.20
	14"(356mm)	42"(1067mm)	UXNL-1742-NSN	2347.80	2606.97
	14"(356mm)	48"(1219mm)	UXNL-1748-NSN	2564.69	2845.53
	14"(356mm)	54"(1372mm)	UXNL-1754-NSN	2781.58	3084.09
	14"(356mm)	60"(1524mm)	UXNL-1760-NSN	2998.47	3322.65
	14"(356mm)	66"(1676mm)	UXNL-1766-NSN	3215.36	3561.21
	14"(356mm)	72"(1829mm)	UXNL-1772-NSN	3432.25	3799.77
	14"(356mm)	78"(1981mm)	UXNL-1778-NSN	3666.35	4055.54
	14"(356mm)	84"(2134mm)	UXNL-1784-NSN	3883.24	4294.10
	14"(356mm)	90"(2286mm)	UXNL-1790-NSN	4100.13	4532.66
	14"(356mm)	96"(2438mm)	UXNL-1796-NSN	4317.02	4771.22

Wood — Legal Depth					
16.56"(421mm)	16.5"(419mm)	30"(762mm)	UXND-1730-NSN	\$ 2151.40	\$ 2392.69
	16.5"(419mm)	36"(914mm)	UXND-1736-NSN	2368.29	2631.25
	16.5"(419mm)	42"(1067mm)	UXND-1742-NSN	2602.39	2887.02
	16.5"(419mm)	48"(1219mm)	UXND-1748-NSN	2819.28	3125.58
	16.5"(419mm)	54"(1372mm)	UXND-1754-NSN	3036.17	3364.14
	16.5"(419mm)	60"(1524mm)	UXND-1760-NSN	3253.06	3602.70
	16.5"(419mm)	66"(1676mm)	UXND-1766-NSN	3469.95	3841.26
	16.5"(419mm)	72"(1829mm)	UXND-1772-NSN	3686.84	4079.82
	16.5"(419mm)	78"(1981mm)	UXND-1778-NSN	3920.94	4335.59
	84"(2134mm)	16.5"(419mm)	UXND-1784-NSN	4137.83	4574.15
	90"(2286mm)	16.5"(419mm)	UXND-1790-NSN	4354.72	4812.71
	96"(2438mm)	16.5"(419mm)	UXND-1796-NSN	4571.61	5051.27

Overhead Storage Unit

2H Open

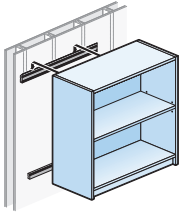

30" and 36" widths

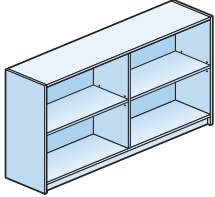

42"-72" widths

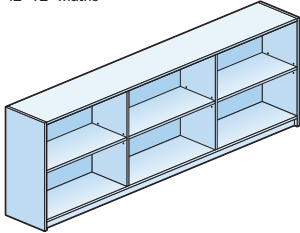

78"-96" widths
ULNL-SN
ULND-SN
UXNL-SN
UXND-SN
Class RA

Features

- Includes storage cabinet(s) with 2" (51mm) integrated light valance, one adjustable shelf and 4" (102mm) French cleat with anti-dislodgement feature.
- Shipped assembled.

Specification Tips

- Accommodates separately specified tackboards and lighting accessories.
- Must be properly anchored to a structural wall.
- Anchors are not provided, must be field supplied.

To Order, Specify:

- 1) Product number.
- 2) Finish code (laminated or wood).
- 3) Laminate edge trim color (if laminate specified).

Overhead Storage Unit

2H Open

Height	Depth	Width	Number	HPL	
				A	B
HPL — Letter Depth					
29.125"(740mm)	30"(762mm)	14"(356mm)	ULNL-2930-NSN	\$ 1370.92	\$ 1453.03
	36"(914mm)	14"(356mm)	ULNL-2936-NSN	1524.20	1618.78
	42"(1067mm)	14"(356mm)	ULNL-2942-NSN	1694.69	1801.74
	48"(1219mm)	14"(356mm)	ULNL-2948-NSN	1847.97	1967.49
	54"(1372mm)	14"(356mm)	ULNL-2954-NSN	2001.25	2133.24
	60"(1524mm)	14"(356mm)	ULNL-2960-NSN	2154.53	2298.99
	66"(1676mm)	14"(356mm)	ULNL-2966-NSN	2307.81	2464.74
	72"(1829mm)	14"(356mm)	ULNL-2972-NSN	2461.09	2630.49
	78"(1981mm)	14"(356mm)	ULNL-2978-NSN	2631.58	2813.45
	84"(2134mm)	14"(356mm)	ULNL-2984-NSN	2784.86	2979.20
	90"(2286mm)	14"(356mm)	ULNL-2990-NSN	2938.14	3144.95
	96"(2438mm)	14"(356mm)	ULNL-2996-NSN	3091.42	3310.70

HPL — Legal Depth					
29.125"(740mm)	30"(762mm)	16.5"(419mm)	ULND-2930-NSN	\$ 1527.30	\$ 1621.91
	36"(914mm)	16.5"(419mm)	ULND-2936-NSN	1680.58	1787.66
	42"(1067mm)	16.5"(419mm)	ULND-2942-NSN	1851.07	1970.62
	48"(1219mm)	16.5"(419mm)	ULND-2948-NSN	2004.35	2136.37
	54"(1372mm)	16.5"(419mm)	ULND-2954-NSN	2157.63	2302.12
	60"(1524mm)	16.5"(419mm)	ULND-2960-NSN	2310.91	2467.87
	66"(1676mm)	16.5"(419mm)	ULND-2966-NSN	2464.19	2633.62
	72"(1829mm)	16.5"(419mm)	ULND-2972-NSN	2617.47	2799.37
	78"(1981mm)	16.5"(419mm)	ULND-2978-NSN	2787.96	2982.33
	84"(2134mm)	16.5"(419mm)	ULND-2984-NSN	2941.24	3148.08
	90"(2286mm)	16.5"(419mm)	ULND-2990-NSN	3094.52	3313.83
	96"(2438mm)	16.5"(419mm)	ULND-2996-NSN	3247.80	3479.58

Height	Depth	Width	Number	Wood	
				A	B
Wood — Letter Depth					
29.125"(740mm)	30"(762mm)	14"(356mm)	UXNL-2930-NSN	\$2344.89	\$2605.12
	36"(914mm)	14"(356mm)	UXNL-2936-NSN	2627.78	2916.30
	42"(1067mm)	14"(356mm)	UXNL-2942-NSN	2927.88	3244.69
	48"(1219mm)	14"(356mm)	UXNL-2948-NSN	3210.77	3555.87
	54"(1372mm)	14"(356mm)	UXNL-2954-NSN	3493.66	3867.05
	60"(1524mm)	14"(356mm)	UXNL-2960-NSN	3776.55	4178.23
	66"(1676mm)	14"(356mm)	UXNL-2966-NSN	4059.44	4489.41
	72"(1829mm)	14"(356mm)	UXNL-2972-NSN	4342.33	4800.59
	78"(1981mm)	14"(356mm)	UXNL-2978-NSN	4642.43	5128.98
	84"(2134mm)	14"(356mm)	UXNL-2984-NSN	4925.32	5440.16
	90"(2286mm)	14"(356mm)	UXNL-2990-NSN	5208.21	5751.34
	96"(2438mm)	14"(356mm)	UXNL-2996-NSN	5491.10	6062.52

Wood — Legal Depth					
29.125"(740mm)	30"(762mm)	16.5"(419mm)	UXND-2930-NSN	\$2599.48	\$2885.17
	36"(914mm)	16.5"(419mm)	UXND-2936-NSN	2882.37	3196.35
	42"(1067mm)	16.5"(419mm)	UXND-2942-NSN	3182.47	3524.74
	48"(1219mm)	16.5"(419mm)	UXND-2948-NSN	3465.36	3835.92
	54"(1372mm)	16.5"(419mm)	UXND-2954-NSN	3748.25	4147.10
	60"(1524mm)	16.5"(419mm)	UXND-2960-NSN	4031.14	4458.28
	66"(1676mm)	16.5"(419mm)	UXND-2966-NSN	4314.03	4769.46
	72"(1829mm)	16.5"(419mm)	UXND-2972-NSN	4596.92	5080.64
	78"(1981mm)	16.5"(419mm)	UXND-2978-NSN	4897.02	5409.03
	84"(2134mm)	16.5"(419mm)	UXND-2984-NSN	5179.91	5720.21
	90"(2286mm)	16.5"(419mm)	UXND-2990-NSN	5462.80	6031.39
	96"(2438mm)	16.5"(419mm)	UXND-2996-NSN	5745.69	6342.57

Overhead Storage Unit

1H Hinged Doors

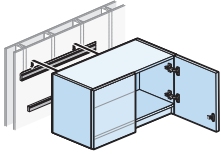

30" and 36" widths
ULOL-SN
ULOD-SN
UXOL-SN
UXOD-SN

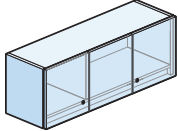

42-54" widths
ULOL-SL
ULOD-SL
UXOL-SL
UXOD-SL

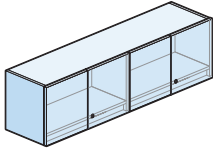

60"-72" widths
ULOL-SN
ULOD-SN
UXOL-SN
UXOD-SN

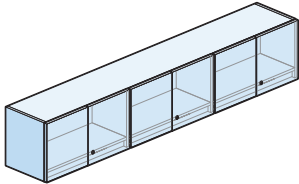

78"-96" widths
ULOL-SN
ULOD-SN
UXOL-SN
UXOD-SN
Class RA

Features

- Includes storage cabinet(s) with hinged doors, 2"(51mm) integrated light valance and 4"(102mm) French cleat with anti-dislodgement feature.
- 42"(1067mm), 48"(1219mm) and 54"(1372mm)W units available with choice of left or right door swing for single door.
- Common keys within each unit.
- Lock plug is available in black or chrome.
- For lock options, refer to Lock Program section of the Accessories Price List.
- Shipped assembled.

Specification Tips

- Accommodates separately specified tackboards and lighting accessories.
- Must be properly anchored to a structural wall.
- Anchors are not provided, must be field supplied.

To Order, Specify:

1) Product number.

1 Lock Option:

- N** No Lock
- L** Lock
 - 30"-36" (add **\$177.50** list)
 - 42"-72" (add **\$355.01** list)
 - 78"-96" (add **\$532.52** list)

2 Single Door Swing Orientation: (42", 48" and 54"W only)

- L** Left-hand
- R** Right-hand

- 2) Finish code (laminated or wood).
- 3) Laminate edge trim color (if laminate specified).
- 4) Trim color for lock (if specified).

Overhead Storage Unit

1H Hinged Doors

Height	Depth	Width	Number ① ②	HPL	
				A	B
HPL — Letter Depth					
16.56"(421mm)	14"(356mm)	30"(762mm)	ULOL-1730- SN	\$ 1509.15	\$ 1602.36
	14"(356mm)	36"(914mm)	ULOL-1736- SN	1644.75	1748.88
	14"(356mm)	42"(1067mm)	ULOL-1742- S	1797.56	1912.61
	14"(356mm)	48"(1219mm)	ULOL-1748- S	1933.16	2059.13
	14"(356mm)	54"(1372mm)	ULOL-1754- S	2068.76	2205.65
	14"(356mm)	60"(1524mm)	ULOL-1760- SN	2204.36	2352.17
	14"(356mm)	66"(1676mm)	ULOL-1766- SN	2339.96	2498.69
	14"(356mm)	72"(1829mm)	ULOL-1772- SN	2475.56	2645.21
	14"(356mm)	78"(1981mm)	ULOL-1778- SN	2628.37	2808.94
	14"(356mm)	84"(2134mm)	ULOL-1784- SN	2763.97	2955.46
	14"(356mm)	90"(2286mm)	ULOL-1790- SN	2899.57	3101.98
	14"(356mm)	96"(2438mm)	ULOL-1796- SN	3035.17	3248.50

HPL — Legal Depth					
16.56"(421mm)	16.5"(419mm)	30"(762mm)	ULOD-1730- SN	\$ 1665.53	\$ 1771.24
	16.5"(419mm)	36"(914mm)	ULOD-1736- SN	1801.13	1917.76
	16.5"(419mm)	42"(1067mm)	ULOD-1742- S	1953.94	2081.49
	16.5"(419mm)	48"(1219mm)	ULOD-1748- S	2089.54	2228.01
	16.5"(419mm)	54"(1372mm)	ULOD-1754- S	2225.14	2374.53
	16.5"(419mm)	60"(1524mm)	ULOD-1760- SN	2360.74	2521.05
	16.5"(419mm)	66"(1676mm)	ULOD-1766- SN	2496.34	2667.57
	16.5"(419mm)	72"(1829mm)	ULOD-1772- SN	2631.94	2814.09
	16.5"(419mm)	78"(1981mm)	ULOD-1778- SN	2784.75	2977.82
	16.5"(419mm)	84"(2134mm)	ULOD-1784- SN	2920.35	3124.34
	16.5"(419mm)	90"(2286mm)	ULOD-1790- SN	3055.95	3270.86
	16.5"(419mm)	96"(2438mm)	ULOD-1796- SN	3191.55	3417.38

Height	Depth	Width	Number ① ②	Wood	
				A	B
Wood — Letter Depth					
16.56"(421mm)	14"(356mm)	30"(762mm)	UXOL-1730- SN	\$ 2651.19	\$ 2942.46
	14"(356mm)	36"(914mm)	UXOL-1736- SN	2902.03	3218.38
	14"(356mm)	42"(1067mm)	UXOL-1742- S	3170.08	3511.51
	14"(356mm)	48"(1219mm)	UXOL-1748- S	3420.92	3787.43
	14"(356mm)	54"(1372mm)	UXOL-1754- S	3671.76	4063.35
	14"(356mm)	60"(1524mm)	UXOL-1760- SN	3922.60	4339.27
	14"(356mm)	66"(1676mm)	UXOL-1766- SN	4173.44	4615.19
	14"(356mm)	72"(1829mm)	UXOL-1772- SN	4424.28	4891.11
	14"(356mm)	78"(1981mm)	UXOL-1778- SN	4692.33	5184.24
	14"(356mm)	84"(2134mm)	UXOL-1784- SN	4943.17	5460.16
	14"(356mm)	90"(2286mm)	UXOL-1790- SN	5194.01	5736.08
	14"(356mm)	96"(2438mm)	UXOL-1796- SN	5444.85	6012.00

Wood — Legal Depth					
16.56"(421mm)	16.5"(419mm)	30"(762mm)	UXOD-1730- SN	\$ 2905.78	\$ 3222.51
	16.5"(419mm)	36"(914mm)	UXOD-1736- SN	3156.62	3498.43
	16.5"(419mm)	42"(1067mm)	UXOD-1742- S	3424.67	3791.56
	16.5"(419mm)	48"(1219mm)	UXOD-1748- S	3675.51	4067.48
	16.5"(419mm)	54"(1372mm)	UXOD-1754- S	3926.35	4343.40
	16.5"(419mm)	60"(1524mm)	UXOD-1760- SN	4177.19	4619.32
	16.5"(419mm)	66"(1676mm)	UXOD-1766- SN	4428.03	4895.24
	16.5"(419mm)	72"(1829mm)	UXOD-1772- SN	4678.87	5171.16
	16.5"(419mm)	78"(1981mm)	UXOD-1778- SN	4946.92	5464.29
	16.5"(419mm)	84"(2134mm)	UXOD-1784- SN	5197.76	5740.21
	16.5"(419mm)	90"(2286mm)	UXOD-1790- SN	5448.60	6016.13
	16.5"(419mm)	96"(2438mm)	UXOD-1796- SN	5699.44	6292.05

Overhead Storage Unit

1.5H Hinged Doors

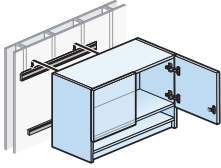

30" and 36" widths

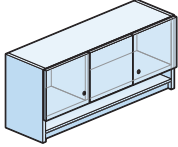

42-54" widths

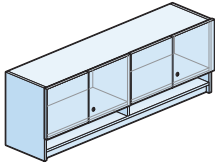

60-72" widths

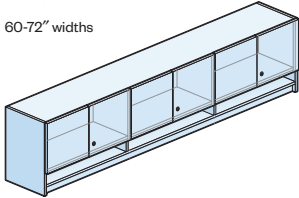

78-96" widths

ULOL-SN
 ULOD-SN
 UXOL-SN
 UXOD-SN
 ULOL-SL
 ULOD-SL
 UXOL-SL
 UXOD-SL

Class RA

Features

- Includes storage cabinet(s) with hinged doors, 3.25"(83mm) cubbies, 2"(51mm) integrated light valance and 4"(102mm) French cleat with anti-dislodgement feature.
- 42"(1067mm), 48"(1219mm) and 54"(1372mm)W units available with choice of left or right door swing for single door.
- Common keys within each unit.
- Lock plug is available in black or chrome.
- For lock options, refer to Lock Program section of the Accessories Price List.
- Shipped assembled.

Specification Tips

- Accommodates separately specified tackboards and lighting accessories.
- Must be properly anchored to a structural wall.
- Anchors are not provided, must be field supplied.

To Order, Specify:

1) Product number, including:

1 Lock Option:

- N** No Lock
- L** Lock
 - 30"-36" (add **\$177.50** list)
 - 42"-72" (add **\$355.01** list)
 - 78"-96" (add **\$532.52** list)

2 Single Door Swing Orientation:
 (42", 48" and 54"W only)

- L** Left-hand
- R** Right-hand

- 2) Finish code (laminated or wood).
- 3) Laminate edge trim color (if laminate specified).
- 4) Trim color for lock (if specified).

Overhead Storage Unit

1.5H Hinged Doors

Height	Depth	Width	Number ① ②	HPL	
				A	B
HPL — Letter Depth					
21"(533mm)	14"(356mm)	30"(762mm)	ULOL-2130- SN	\$ 1671.31	\$ 1777.16
		36"(914mm)	ULOL-2136- SN	1842.90	1962.77
		42"(1067mm)	ULOL-2142- S	2031.70	2165.59
		48"(1219mm)	ULOL-2148- S	2203.29	2351.20
		54"(1372mm)	ULOL-2154- S	2374.88	2536.81
		60"(1524mm)	ULOL-2160- SN	2546.47	2722.42
		66"(1676mm)	ULOL-2166- SN	2718.06	2908.03
		72"(1829mm)	ULOL-2172- SN	2889.65	3093.64
		78"(1981mm)	ULOL-2178- SN	3078.45	3296.46
		84"(2134mm)	ULOL-2184- SN	3250.04	3482.07
		90"(2286mm)	ULOL-2190- SN	3421.63	3667.68
		96"(2438mm)	ULOL-2196- SN	3593.22	3853.29

HPL — Legal Depth					
21"(533mm)	16.5"(419mm)	30"(762mm)	ULOD-2130- SN	\$ 1827.69	\$ 1946.04
		36"(914mm)	ULOD-2136- SN	1999.28	2131.65
		42"(1067mm)	ULOD-2142- S	2188.08	2334.47
		48"(1219mm)	ULOD-2148- S	2359.67	2520.08
		54"(1372mm)	ULOD-2154- S	2531.26	2705.69
		60"(1524mm)	ULOD-2160- SN	2702.85	2891.30
		66"(1676mm)	ULOD-2166- SN	2874.44	3076.91
		72"(1829mm)	ULOD-2172- SN	3046.03	3262.52
		78"(1981mm)	ULOD-2178- SN	3234.83	3465.34
		84"(2134mm)	ULOD-2184- SN	3406.42	3650.95
		90"(2286mm)	ULOD-2190- SN	3578.01	3836.56
		96"(2438mm)	ULOD-2196- SN	3749.60	4022.17

Height	Depth	Width	Number ① ②	Wood	
				A	B
Wood — Letter Depth					
21"(533mm)	14"(356mm)	30"(762mm)	UXOL-2130- SN	\$ 2949.91	\$ 3270.78
		36"(914mm)	UXOL-2136- SN	3266.75	3619.32
		42"(1067mm)	UXOL-2142- S	3600.80	3985.07
		48"(1219mm)	UXOL-2148- S	3917.64	4333.61
		54"(1372mm)	UXOL-2154- S	4234.48	4682.15
		60"(1524mm)	UXOL-2160- SN	4551.32	5030.69
		66"(1676mm)	UXOL-2166- SN	4868.16	5379.23
		72"(1829mm)	UXOL-2172- SN	5185.00	5727.77
		78"(1981mm)	UXOL-2178- SN	5519.05	6093.52
		84"(2134mm)	UXOL-2184- SN	5835.89	6442.06
		90"(2286mm)	UXOL-2190- SN	6152.73	6790.60
		96"(2438mm)	UXOL-2196- SN	6469.57	7139.14

Wood — Legal Depth					
21"(533mm)	16.5"(419mm)	30"(762mm)	UXOD-2130- SN	\$ 3204.50	\$ 3550.83
		36"(914mm)	UXOD-2136- SN	3521.34	3899.37
		42"(1067mm)	UXOD-2142- S	3855.39	4265.12
		48"(1219mm)	UXOD-2148- S	4172.23	4613.66
		54"(1372mm)	UXOD-2154- S	4489.07	4962.20
		60"(1524mm)	UXOD-2160- SN	4805.91	5310.74
		66"(1676mm)	UXOD-2166- SN	5122.75	5659.28
		72"(1829mm)	UXOD-2172- SN	5439.59	6007.82
		78"(1981mm)	UXOD-2178- SN	5773.64	6373.57
		84"(2134mm)	UXOD-2184- SN	6090.48	6722.11
		90"(2286mm)	UXOD-2190- SN	6407.32	7070.65
		96"(2438mm)	UXOD-2196- SN	6724.16	7419.19

Overhead Storage Unit

2H Hinged Doors

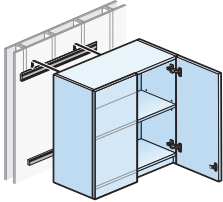

30" and 36" widths
ULOL-SN
ULOD-SN
UXOL-SN
UXOD-SN

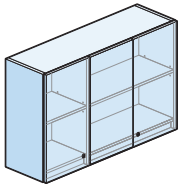

42"-54" widths
ULOL-SL
ULOD-SL
UXOL-SL
UXOD-SL

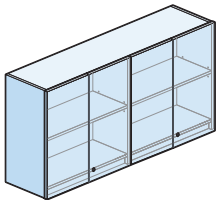

60"-72" widths
ULOL-SN
ULOD-SN
UXOL-SN
UXOD-SN

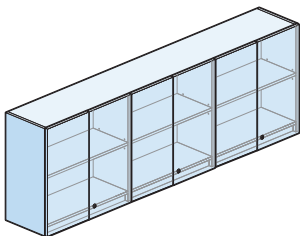

78" and 96" widths
ULOL-SN
ULOD-SN
UXOL-SN
UXOD-SN
Class RA

Features

- Includes storage cabinet(s) with hinged doors, 2"(51mm) integrated light valance, one adjustable shelf and 4"(102mm) French cleat with anti-dislodgement feature.
- 42"(1067mm), 48"(1219mm) and 54"(1372mm)W units available with choice of left or right door swing for single door.
- Common keys within each unit.
- Lock plug is available in black or chrome.
- For lock options, refer to Lock Program section of the Accessories Price List.
- Shipped assembled.

Specification Tips

- Accommodates separately specified tackboards and lighting accessories.
- Must be properly anchored to a structural wall.
- Anchors are not provided, must be field supplied.

To Order, Specify:

1) Product number, including:

1 Lock Option:

- N** No Lock
- L** Lock
 - 30"-36" (add **\$177.50** list)
 - 42"-72" (add **\$355.01** list)
 - 78"-96" (add **\$532.52** list)

2 Single Door Swing Orientation:
(42", 48" and 54"W only)

- L** Left-hand
- R** Right-hand

- 2) Finish code (laminated or wood).
- 3) Laminate edge trim color (if laminate specified).
- 4) Trim color for lock (if specified).

Overhead Storage Unit

2H Hinged Doors

Height	Depth	Width	Number ① ②	HPL	
				A	B
HPL — Letter Depth					
29.125"(740mm)	14"(356mm)	30"(762mm)	ULOL-2930- SN	\$ 1995.63	\$ 2126.76
	14"(356mm)	36"(914mm)	ULOL-2936- SN	2167.22	2312.37
	14"(356mm)	42"(1067mm)	ULOL-2942- S	2356.02	2515.19
	14"(356mm)	48"(1219mm)	ULOL-2948- S	2527.61	2700.80
	14"(356mm)	54"(1372mm)	ULOL-2954- S	2699.20	2886.41
	14"(356mm)	60"(1524mm)	ULOL-2960- SN	2870.79	3072.02
	14"(356mm)	66"(1676mm)	ULOL-2966- SN	3042.38	3257.63
	14"(356mm)	72"(1829mm)	ULOL-2972- SN	3213.97	3443.24
	14"(356mm)	78"(1981mm)	ULOL-2978- SN	3402.77	3646.06
	14"(356mm)	84"(2134mm)	ULOL-2984- SN	3574.36	3831.67
	14"(356mm)	90"(2286mm)	ULOL-2990- SN	3745.95	4017.28
	14"(356mm)	96"(2438mm)	ULOL-2996- SN	3917.54	4202.89

HPL — Legal Depth					
29.125"(740mm)	16.5"(419mm)	30"(762mm)	ULOD-2930- SN	\$ 2152.01	\$ 2295.64
	16.5"(419mm)	36"(914mm)	ULOD-2936- SN	2323.60	2481.25
	16.5"(419mm)	42"(1067mm)	ULOD-2942- S	2512.40	2684.07
	16.5"(419mm)	48"(1219mm)	ULOD-2948- S	2683.99	2869.68
	16.5"(419mm)	54"(1372mm)	ULOD-2954- S	2855.58	3055.29
	16.5"(419mm)	60"(1524mm)	ULOD-2960- SN	3027.17	3240.90
	16.5"(419mm)	66"(1676mm)	ULOD-2966- SN	3198.76	3426.51
	16.5"(419mm)	72"(1829mm)	ULOD-2972- SN	3370.35	3612.12
	16.5"(419mm)	78"(1981mm)	ULOD-2978- SN	3559.15	3814.94
	16.5"(419mm)	84"(2134mm)	ULOD-2984- SN	3730.74	4000.55
	16.5"(419mm)	90"(2286mm)	ULOD-2990- SN	3902.33	4186.16
	16.5"(419mm)	96"(2438mm)	ULOD-2996- SN	4073.92	4371.77

Height	Depth	Width	Number ① ②	Wood	
				A	B
Wood — Letter Depth					
29.125"(740mm)	14"(356mm)	30"(762mm)	UXOL-2930- SN	\$ 3547.35	\$ 3927.42
	14"(356mm)	36"(914mm)	UXOL-2936- SN	3864.19	4275.96
	14"(356mm)	42"(1067mm)	UXOL-2942- S	4198.24	4641.71
	14"(356mm)	48"(1219mm)	UXOL-2948- S	4515.08	4990.25
	14"(356mm)	54"(1372mm)	UXOL-2954- S	4831.92	5338.79
	14"(356mm)	60"(1524mm)	UXOL-2960- SN	5148.76	5687.33
	14"(356mm)	66"(1676mm)	UXOL-2966- SN	5465.60	6035.87
	14"(356mm)	72"(1829mm)	UXOL-2972- SN	5782.44	6384.41
	14"(356mm)	78"(1981mm)	UXOL-2978- SN	6116.49	6750.16
	14"(356mm)	84"(2134mm)	UXOL-2984- SN	6433.33	7098.70
	14"(356mm)	90"(2286mm)	UXOL-2990- SN	6750.17	7447.24
	14"(356mm)	96"(2438mm)	UXOL-2996- SN	7067.01	7795.78

Wood — Legal Depth					
29.125"(740mm)	16.5"(419mm)	30"(762mm)	UXOD-2930- SN	\$ 3801.94	\$ 4207.47
	16.5"(419mm)	36"(914mm)	UXOD-2936- SN	4118.78	4556.01
	16.5"(419mm)	42"(1067mm)	UXOD-2942- S	4452.83	4921.76
	16.5"(419mm)	48"(1219mm)	UXOD-2948- S	4769.67	5270.30
	16.5"(419mm)	54"(1372mm)	UXOD-2954- S	5086.51	5618.84
	16.5"(419mm)	60"(1524mm)	UXOD-2960- SN	5403.35	5967.38
	16.5"(419mm)	66"(1676mm)	UXOD-2966- SN	5720.19	6315.92
	16.5"(419mm)	72"(1829mm)	UXOD-2972- SN	6037.03	6664.46
	16.5"(419mm)	78"(1981mm)	UXOD-2978- SN	6371.08	7030.21
	16.5"(419mm)	84"(2134mm)	UXOD-2984- SN	6687.92	7378.75
	16.5"(419mm)	90"(2286mm)	UXOD-2990- SN	7004.76	7727.29
	16.5"(419mm)	96"(2438mm)	UXOD-2996- SN	7321.60	8075.83

Overhead Storage Unit

1H Sliding Door

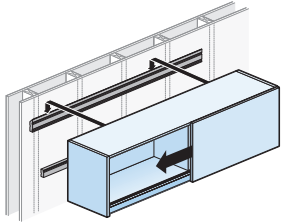

30"-72" widths

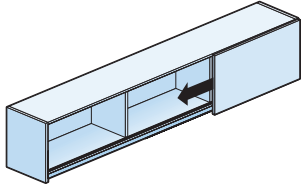

78"-96" widths

ULRL-SN
ULRD-SN
UXRL-SN
UXRD-SN

Class RA

Features

- Includes storage cabinet(s) with one sliding door, 2"(51mm) integrated light valance and 4"(102mm) French cleat with anti-dislodgement feature.
- Units 30"-72"(762mm-1829mm)W include two equal width sections divided by one inset intermediate center support.
- Units 78"-96"(1981mm-2438mm)W include three equal width sections divided by two inset intermediate center supports.
- Sliding door width is equal to one section width (one-half or one-third of unit width).
- Locks not available.
- Includes internally mounted sliding door track top and bottom with bumpers at each end.
- Shipped assembled.

Specification Tips

- Accommodates separately specified tackboards and lighting accessories.
- Must be properly anchored to a structural wall.
- Anchors are not provided, must be field supplied.

To Order, Specify:

- 1) Product number.
- 2) Finish code (laminated or wood).
- 3) Laminate edge trim color (if laminate specified).

Overhead Storage Unit

1H Sliding Door

Height	Depth	Width	Number	HPL	
				A	B
HPL — Letter Depth					
16.56"(421mm)	14"(356mm)	30"(762mm)	ULRL-1730-NSN	\$ 1380.11	\$ 1462.17
	14"(356mm)	36"(914mm)	ULRL-1736-NSN	1502.48	1594.32
	14"(356mm)	42"(1067mm)	ULRL-1742-NSN	1642.06	1743.68
	14"(356mm)	48"(1219mm)	ULRL-1748-NSN	1764.43	1875.83
	14"(356mm)	54"(1372mm)	ULRL-1754-NSN	1886.80	2007.98
	14"(356mm)	60"(1524mm)	ULRL-1760-NSN	2009.17	2140.13
	14"(356mm)	66"(1676mm)	ULRL-1766-NSN	2131.54	2272.28
	14"(356mm)	72"(1829mm)	ULRL-1772-NSN	2253.91	2404.43
	14"(356mm)	78"(1981mm)	ULRL-1778-NSN	2393.49	2553.79
	14"(356mm)	84"(2134mm)	ULRL-1784-NSN	2515.86	2685.94
	14"(356mm)	90"(2286mm)	ULRL-1790-NSN	2638.23	2818.09
	14"(356mm)	96"(2438mm)	ULRL-1796-NSN	2760.60	2950.24
HPL — Legal Depth					
16.56"(421mm)	16.5"(419mm)	30"(762mm)	ULRD-1730-NSN	\$ 1536.49	\$ 1631.05
	16.5"(419mm)	36"(914mm)	ULRD-1736-NSN	1658.86	1763.20
	16.5"(419mm)	42"(1067mm)	ULRD-1742-NSN	1798.44	1912.56
	16.5"(419mm)	48"(1219mm)	ULRD-1748-NSN	1920.81	2044.71
	16.5"(419mm)	54"(1372mm)	ULRD-1754-NSN	2043.18	2176.86
	16.5"(419mm)	60"(1524mm)	ULRD-1760-NSN	2165.55	2309.01
	16.5"(419mm)	66"(1676mm)	ULRD-1766-NSN	2287.92	2441.16
	16.5"(419mm)	72"(1829mm)	ULRD-1772-NSN	2410.29	2573.31
	16.5"(419mm)	78"(1981mm)	ULRD-1778-NSN	2549.87	2722.67
	16.5"(419mm)	84"(2134mm)	ULRD-1784-NSN	2672.24	2854.82
	16.5"(419mm)	90"(2286mm)	ULRD-1790-NSN	2794.61	2986.97
	16.5"(419mm)	96"(2438mm)	ULRD-1796-NSN	2916.98	3119.12
Wood					
Height	Depth	Width	Number	Wood	
				A	B
Wood — Letter Depth					
16.56"(421mm)	14"(356mm)	30"(762mm)	UXRL-1730-NSN	\$ 2368.29	\$ 2631.27
	14"(356mm)	36"(914mm)	UXRL-1736-NSN	2594.62	2880.20
	14"(356mm)	42"(1067mm)	UXRL-1742-NSN	2838.16	3146.34
	14"(356mm)	48"(1219mm)	UXRL-1748-NSN	3064.49	3395.27
	14"(356mm)	54"(1372mm)	UXRL-1754-NSN	3290.82	3644.20
	14"(356mm)	60"(1524mm)	UXRL-1760-NSN	3517.15	3893.13
	14"(356mm)	66"(1676mm)	UXRL-1766-NSN	3743.48	4142.06
	14"(356mm)	72"(1829mm)	UXRL-1772-NSN	3969.81	4390.99
	14"(356mm)	78"(1981mm)	UXRL-1778-NSN	4213.35	4657.13
	14"(356mm)	84"(2134mm)	UXRL-1784-NSN	4439.68	4906.06
	14"(356mm)	90"(2286mm)	UXRL-1790-NSN	4666.01	5154.99
	14"(356mm)	96"(2438mm)	UXRL-1796-NSN	4892.34	5403.92
Wood — Legal Depth					
16.56"(421mm)	16.5"(419mm)	30"(762mm)	UXRD-1730-NSN	\$ 2622.88	\$ 2911.32
	16.5"(419mm)	36"(914mm)	UXRD-1736-NSN	2849.21	3160.25
	16.5"(419mm)	42"(1067mm)	UXRD-1742-NSN	3092.75	3426.39
	16.5"(419mm)	48"(1219mm)	UXRD-1748-NSN	3319.08	3675.32
	16.5"(419mm)	54"(1372mm)	UXRD-1754-NSN	3545.41	3924.25
	16.5"(419mm)	60"(1524mm)	UXRD-1760-NSN	3771.74	4173.18
	16.5"(419mm)	66"(1676mm)	UXRD-1766-NSN	3998.07	4422.11
	16.5"(419mm)	72"(1829mm)	UXRD-1772-NSN	4224.40	4671.04
	16.5"(419mm)	78"(1981mm)	UXRD-1778-NSN	4467.94	4937.18
	16.5"(419mm)	84"(2134mm)	UXRD-1784-NSN	4694.27	5186.11
	16.5"(419mm)	90"(2286mm)	UXRD-1790-NSN	4920.60	5435.04
	16.5"(419mm)	96"(2438mm)	UXRD-1796-NSN	5146.93	5683.97

Overhead Storage Unit

1.5H Sliding Door

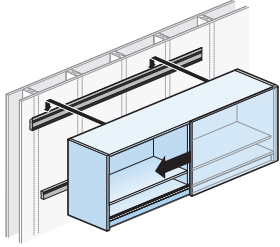

30"-72" widths

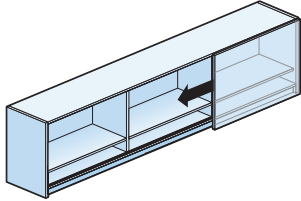

78"-96" widths
 ULRL-SN
 ULRD-SN
 UXRL-SN
 UXRD-SN
 Class RA

Features

- Includes storage cabinet(s) with one sliding door, 3.25"(83mm) cubbies, 2"(51mm) integrated light valance and 4"(102mm) French cleat with anti-dislodgement feature.
- Units 30"-72"(762mm-1829mm)W include two equal width sections divided by one inset intermediate center support.
- Units 78"-96"(1981mm-2438mm)W include three equal width sections divided by two inset intermediate center supports.
- Sliding door width is equal to one section width (one-half or one-third of unit width).
- Locks not available.
- Includes internally mounted sliding door track top and bottom with bumpers at each end.
- Shipped assembled.

Specification Tips

- Accommodates separately specified tackboards and lighting accessories.
- Must be properly anchored to a structural wall.
- Anchors are not provided, must be field supplied.

To Order, Specify:

- 1) Product number.
- 2) Finish code (laminated or wood).
- 3) Laminate edge trim color (if laminate specified).

Overhead Storage Unit

1.5H Sliding Door

Height	Depth	Depth	Number	HPL	
				A	B
HPL — Letter Depth					
21"(533mm)	14"(356mm)	30"(762mm)	ULRL-2130-NSN	\$ 1477.83	\$ 1567.77
	14"(356mm)	36"(914mm)	ULRL-2136-NSN	1636.19	1739.01
	14"(356mm)	42"(1067mm)	ULRL-2142-NSN	1811.76	1927.46
	14"(356mm)	48"(1219mm)	ULRL-2148-NSN	1970.12	2098.70
	14"(356mm)	54"(1372mm)	ULRL-2154-NSN	2128.48	2269.94
	14"(356mm)	60"(1524mm)	ULRL-2160-NSN	2286.84	2441.18
	14"(356mm)	66"(1676mm)	ULRL-2166-NSN	2445.20	2612.42
	14"(356mm)	72"(1829mm)	ULRL-2172-NSN	2603.56	2783.66
	14"(356mm)	78"(1981mm)	ULRL-2178-NSN	2779.13	2972.11
	14"(356mm)	84"(2134mm)	ULRL-2184-NSN	2937.49	3143.35
	14"(356mm)	90"(2286mm)	ULRL-2190-NSN	3095.85	3314.59
	14"(356mm)	96"(2438mm)	ULRL-2196-NSN	3254.21	3485.83

HPL — Legal Depth					
21"(533mm)	16.5"(419mm)	30"(762mm)	ULRD-2130-NSN	\$ 1634.21	\$ 1736.65
	16.5"(419mm)	36"(914mm)	ULRD-2136-NSN	1792.57	1907.89
	16.5"(419mm)	42"(1067mm)	ULRD-2142-NSN	1968.14	2096.34
	16.5"(419mm)	48"(1219mm)	ULRD-2148-NSN	2126.50	2267.58
	16.5"(419mm)	54"(1372mm)	ULRD-2154-NSN	2284.86	2438.82
	16.5"(419mm)	60"(1524mm)	ULRD-2160-NSN	2443.22	2610.06
	16.5"(419mm)	66"(1676mm)	ULRD-2166-NSN	2601.58	2781.30
	16.5"(419mm)	72"(1829mm)	ULRD-2172-NSN	2759.94	2952.54
	16.5"(419mm)	78"(1981mm)	ULRD-2178-NSN	2935.51	3140.99
	16.5"(419mm)	84"(2134mm)	ULRD-2184-NSN	3093.87	3312.23
	16.5"(419mm)	90"(2286mm)	ULRD-2190-NSN	3252.23	3483.47
	16.5"(419mm)	96"(2438mm)	ULRD-2196-NSN	3410.59	3654.71

Height	Depth	Width	Number	Wood	
				A	B
Wood — Letter Depth					
21"(533mm)	14"(356mm)	30"(762mm)	UXRL-2130-NSN	\$ 2547.49	\$ 2828.31
	14"(356mm)	36"(914mm)	UXRL-2136-NSN	2839.82	3149.86
	14"(356mm)	42"(1067mm)	UXRL-2142-NSN	3149.36	3488.62
	14"(356mm)	48"(1219mm)	UXRL-2148-NSN	3441.69	3810.17
	14"(356mm)	54"(1372mm)	UXRL-2154-NSN	3734.02	4131.72
	14"(356mm)	60"(1524mm)	UXRL-2160-NSN	4026.35	4453.27
	14"(356mm)	66"(1676mm)	UXRL-2166-NSN	4318.68	4774.82
	14"(356mm)	72"(1829mm)	UXRL-2172-NSN	4611.01	5096.37
	14"(356mm)	78"(1981mm)	UXRL-2178-NSN	4920.55	5435.13
	14"(356mm)	84"(2134mm)	UXRL-2184-NSN	5212.88	5756.68
	14"(356mm)	90"(2286mm)	UXRL-2190-NSN	5505.21	6078.23
	14"(356mm)	96"(2438mm)	UXRL-2196-NSN	5797.54	6399.78

Wood — Legal Depth					
21"(533mm)	16.5"(419mm)	30"(762mm)	UXRD-2130-NSN	\$2802.08	\$ 3108.36
	16.5"(419mm)	36"(914mm)	UXRD-2136-NSN	3094.41	3429.91
	16.5"(419mm)	42"(1067mm)	UXRD-2142-NSN	3403.95	3768.67
	16.5"(419mm)	48"(1219mm)	UXRD-2148-NSN	3696.28	4090.22
	16.5"(419mm)	54"(1372mm)	UXRD-2154-NSN	3988.61	4411.77
	16.5"(419mm)	60"(1524mm)	UXRD-2160-NSN	4280.94	4733.32
	16.5"(419mm)	66"(1676mm)	UXRD-2166-NSN	4573.27	5054.87
	16.5"(419mm)	72"(1829mm)	UXRD-2172-NSN	4865.60	5376.42
	16.5"(419mm)	78"(1981mm)	UXRD-2178-NSN	5175.14	5715.18
	16.5"(419mm)	84"(2134mm)	UXRD-2184-NSN	5467.47	6036.73
	16.5"(419mm)	90"(2286mm)	UXRD-2190-NSN	5759.80	6358.28
	16.5"(419mm)	96"(2438mm)	UXRD-2196-NSN	6052.13	6679.83

Overhead Storage Unit

2H Sliding Door

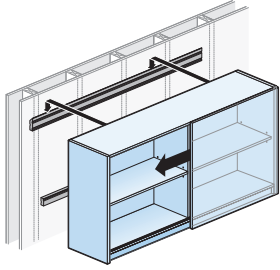

30"-72" widths

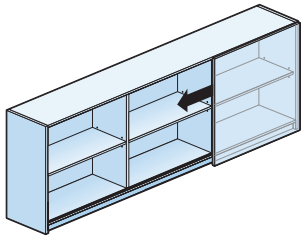

78"-96" widths
 ULR-L-SN
 ULR-D-SN
 UXRL-SN
 UXRD-SN
 Class RA

Features

- Includes storage cabinet(s) with one sliding door, 2"(51mm) integrated light valance, one adjustable shelf and 4"(102mm) French cleat with anti-dislodgement feature.
- Units 30"-72"(762mm-1829mm)W include two equal width sections divided by one inset intermediate center support.
- Units 78"-96"(1981mm-2438mm)W include three equal width sections divided by two inset intermediate center supports.
- Sliding door width is equal to one section width (one-half or one-third of unit width).
- Locks not available.
- Includes internally mounted sliding door track top and bottom with bumpers at each end.
- Shipped assembled.

Specification Tips

- Accommodates separately specified tackboards and lighting accessories.
- Must be properly anchored to a structural wall.
- Anchors are not provided, must be field supplied.

To Order, Specify:

- 1) Product number.
- 2) Finish code (laminated or wood).
- 3) Laminate edge trim color (if laminate specified).

Overhead Storage Unit

2H Sliding Door

Height	Depth	Width	Number	HPL	
				A	B
HPL — Letter Depth					
29.125"(740mm)	14"(356mm)	30"(762mm)	ULRL-2930-NSN	\$ 1673.27	\$ 1778.97
	14"(356mm)	36"(914mm)	ULRL-2936-NSN	1831.63	1950.21
	14"(356mm)	42"(1067mm)	ULRL-2942-NSN	2007.20	2138.66
	14"(356mm)	48"(1219mm)	ULRL-2948-NSN	2165.56	2309.90
	14"(356mm)	54"(1372mm)	ULRL-2954-NSN	2323.92	2481.14
	14"(356mm)	60"(1524mm)	ULRL-2960-NSN	2482.28	2652.38
	14"(356mm)	66"(1676mm)	ULRL-2966-NSN	2640.64	2823.62
	14"(356mm)	72"(1829mm)	ULRL-2972-NSN	2799.00	2994.86
	14"(356mm)	78"(1981mm)	ULRL-2978-NSN	2974.57	3183.31
	14"(356mm)	84"(2134mm)	ULRL-2984-NSN	3132.93	3354.55
	14"(356mm)	90"(2286mm)	ULRL-2990-NSN	3291.29	3525.79
	14"(356mm)	96"(2438mm)	ULRL-2996-NSN	3449.65	3697.03

HPL — Legal Depth					
29.125"(740mm)	16.5"(419mm)	30"(762mm)	ULRD-2930-NSN	\$ 1829.65	\$ 1947.85
	16.5"(419mm)	36"(914mm)	ULRD-2936-NSN	1988.01	2119.09
	16.5"(419mm)	42"(1067mm)	ULRD-2942-NSN	2163.58	2307.54
	16.5"(419mm)	48"(1219mm)	ULRD-2948-NSN	2321.94	2478.78
	16.5"(419mm)	54"(1372mm)	ULRD-2954-NSN	2480.30	2650.02
	16.5"(419mm)	60"(1524mm)	ULRD-2960-NSN	2638.66	2821.26
	16.5"(419mm)	66"(1676mm)	ULRD-2966-NSN	2797.02	2992.50
	16.5"(419mm)	72"(1829mm)	ULRD-2972-NSN	2955.38	3163.74
	16.5"(419mm)	78"(1981mm)	ULRD-2978-NSN	3130.95	3352.19
	16.5"(419mm)	84"(2134mm)	ULRD-2984-NSN	3289.31	3523.43
	16.5"(419mm)	90"(2286mm)	ULRD-2990-NSN	3447.67	3694.67
	16.5"(419mm)	96"(2438mm)	ULRD-2996-NSN	3606.03	3865.91

Height	Depth	Width	Number	Wood	
				A	B
Wood — Letter Depth					
29.125"(740mm)	14"(356mm)	30"(762mm)	UXRL-2930-NSN	\$2905.89	\$ 3222.39
	14"(356mm)	36"(914mm)	UXRL-2936-NSN	3198.22	3543.94
	14"(356mm)	42"(1067mm)	UXRL-2942-NSN	3507.76	3882.70
	14"(356mm)	48"(1219mm)	UXRL-2948-NSN	3800.09	4204.25
	14"(356mm)	54"(1372mm)	UXRL-2954-NSN	4092.42	4525.80
	14"(356mm)	60"(1524mm)	UXRL-2960-NSN	4384.75	4847.35
	14"(356mm)	66"(1676mm)	UXRL-2966-NSN	4677.08	5168.90
	14"(356mm)	72"(1829mm)	UXRL-2972-NSN	4969.41	5490.45
	14"(356mm)	78"(1981mm)	UXRL-2978-NSN	5278.95	5829.21
	14"(356mm)	84"(2134mm)	UXRL-2984-NSN	5571.28	6150.76
	14"(356mm)	90"(2286mm)	UXRL-2990-NSN	5863.61	6472.31
	14"(356mm)	96"(2438mm)	UXRL-2996-NSN	6155.94	6793.86

Wood — Legal Depth					
29.125"(740mm)	16.5"(419mm)	30"(762mm)	UXRD-2930-NSN	\$ 3160.48	\$3502.44
	16.5"(419mm)	36"(914mm)	UXRD-2936-NSN	3452.81	3823.99
	16.5"(419mm)	42"(1067mm)	UXRD-2942-NSN	3762.35	4162.75
	16.5"(419mm)	48"(1219mm)	UXRD-2948-NSN	4054.68	4484.30
	16.5"(419mm)	54"(1372mm)	UXRD-2954-NSN	4347.01	4805.85
	16.5"(419mm)	60"(1524mm)	UXRD-2960-NSN	4639.34	5127.40
	16.5"(419mm)	66"(1676mm)	UXRD-2966-NSN	4931.67	5448.95
	16.5"(419mm)	72"(1829mm)	UXRD-2972-NSN	5224.00	5770.50
	16.5"(419mm)	78"(1981mm)	UXRD-2978-NSN	5533.54	6109.26
	16.5"(419mm)	84"(2134mm)	UXRD-2984-NSN	5825.87	6430.81
	16.5"(419mm)	90"(2286mm)	UXRD-2990-NSN	6118.20	6752.36
	16.5"(419mm)	96"(2438mm)	UXRD-2996-NSN	6410.53	7073.91

Overhead Storage Unit

1H Glass Hinged Doors

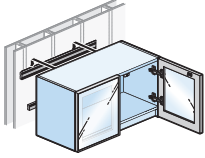

30" and 36" widths
ULML-SN
ULMD-SN
UXML-SN
UXMD-SN

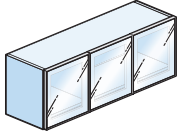

42"-54" widths
ULML-SL
ULMD-SL
UXML-SL
UXMD-SL

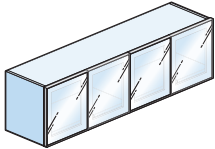

60"-72" widths
ULML-SN
ULMD-SN
UXML-SN
UXMD-SN

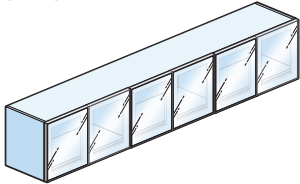

78"-96" widths
ULML-SN
ULMD-SN
UXML-SN
UXMD-SN
Class RA

Features

- Includes storage cabinet(s) with glass doors, 2"(51mm) integrated light valance and 4"(102mm) French cleat with anti-dislodgement feature.
- 42"(1067mm), 48"(1219mm) and 54"(1372mm)W units available with choice of left or right door swing for single door.
- Locks not available.
- Glass door includes metal frame with metallic powdercoat finish on back side of door.
- Glass doors will be field installed.

Specification Tips

- Accommodates separately specified tackboards and lighting accessories.
- Must be properly anchored to a structural wall.
- Anchors are not provided, must be field supplied.

To Order, Specify:

- 1) Product number.
- 1 **Single Door Swing Orientation:**
(42", 48" and 54"W only)
 - L** Left-hand
 - R** Right-hand
- 2) Finish code (laminate or wood).
- 3) Laminate edge trim color (if laminate specified).
- 4) Glass code.
- 5) Trim color for glass frame.

Overhead Storage Unit

1H Glass Hinged Doors

Height	Depth	Width	Number ①	HPL A Glass				HPL B Glass			
				A	C	D	H	A	C	D	H
Letter Depth											
16.56"(421mm)	14"(356mm)	30"(762mm)	ULML-1730-NSN	\$ 2125.59	\$2444.88	\$2626.85	\$3053.10	\$ 2188.14	\$ 2507.43	\$2689.40	\$ 3115.65
	14"(356mm)	36"(914mm)	ULML-1736-NSN	2279.98	2610.80	2800.46	3237.20	2351.90	2682.72	2872.38	3309.12
	14"(356mm)	42"(1067mm)	ULML-1742-NS	2451.58	2793.93	2991.28	3438.51	2532.87	2875.22	3072.57	3519.80
	14"(356mm)	48"(1219mm)	ULML-1748-NS	2605.97	2959.85	3164.89	3622.61	2696.63	3050.51	3255.55	3713.27
	14"(356mm)	54"(1372mm)	ULML-1754-NS	2760.36	3125.77	3338.50	3806.71	2860.39	3225.80	3438.53	3906.74
	14"(356mm)	60"(1524mm)	ULML-1760-NSN	2914.75	3291.69	3512.11	3990.81	3024.15	3401.09	3621.51	4100.21
	14"(356mm)	66"(1676mm)	ULML-1766-NSN	3069.14	3457.61	3685.72	4174.91	3187.91	3576.38	3804.49	4293.68
	14"(356mm)	72"(1829mm)	ULML-1772-NSN	3223.53	3623.53	3859.33	4359.01	3351.67	3751.67	3987.47	4487.15
	14"(356mm)	78"(1981mm)	ULML-1778-NSN	3395.13	3806.66	4050.15	4560.32	3532.64	3944.17	4187.66	4697.83
	14"(356mm)	84"(2134mm)	ULML-1784-NSN	3549.52	3972.58	4223.76	4744.42	3696.40	4119.46	4370.64	4891.30
	14"(356mm)	90"(2286mm)	ULML-1790-NSN	3703.91	4138.50	4397.37	4928.52	3860.16	4294.75	4553.62	5084.77
	14"(356mm)	96"(2438mm)	ULML-1796-NSN	3858.30	4304.42	4570.98	5112.62	4023.92	4470.04	4736.60	5278.24
Legal Depth											
16.56"(421mm)	16.5"(419mm)	30"(762mm)	ULMD-1730-NSN	\$ 2281.97	\$ 2601.26	\$ 2783.23	\$ 3209.48	\$ 2357.02	\$ 2676.31	\$ 2858.28	\$ 3284.53
	16.5"(419mm)	36"(914mm)	ULMD-1736-NSN	2436.36	2767.18	2956.84	3393.58	2520.78	2851.60	3041.26	3478.00
	16.5"(419mm)	42"(1067mm)	ULMD-1742-NS	2607.96	2950.31	3147.66	3594.89	2701.75	3044.10	3241.45	3688.68
	16.5"(419mm)	48"(1219mm)	ULMD-1748-NS	2762.35	3116.23	3321.27	3778.99	2865.51	3219.39	3424.43	3882.15
	16.5"(419mm)	54"(1372mm)	ULMD-1754-NS	2916.74	3282.15	3494.88	3963.09	3029.27	3394.68	3607.41	4075.62
	16.5"(419mm)	60"(1524mm)	ULMD-1760-NSN	3071.13	3448.07	3668.49	4147.19	3193.03	3569.97	3790.39	4269.09
	16.5"(419mm)	66"(1676mm)	ULMD-1766-NSN	3225.52	3613.99	3842.10	4331.29	3356.79	3745.26	3973.37	4462.56
	16.5"(419mm)	72"(1829mm)	ULMD-1772-NSN	3379.91	3779.91	4015.71	4515.39	3520.55	3920.55	4156.35	4656.03
	16.5"(419mm)	78"(1981mm)	ULMD-1778-NSN	3551.51	3963.04	4206.53	4716.70	3701.52	4113.05	4356.54	4866.71
	16.5"(419mm)	84"(2134mm)	ULMD-1784-NSN	3705.90	4128.96	4380.14	4900.80	3865.28	4288.34	4539.52	5060.18
	16.5"(419mm)	90"(2286mm)	ULMD-1790-NSN	3860.29	4294.88	4553.75	5084.90	4029.04	4463.63	4722.50	5253.65
	16.5"(419mm)	96"(2438mm)	ULMD-1796-NSN	4014.68	4460.80	4727.36	5269.00	4192.80	4638.92	4905.48	5447.12

Height	Depth	Width	Number ①	Wood A Glass				Wood B Glass			
				A	C	D	H	A	C	D	H
Letter Depth											
16.56"(421mm)	14"(356mm)	30"(762mm)	UXML-1730-NSN	\$2896.40	\$ 3215.69	\$ 3397.66	\$ 3823.91	\$ 3112.23	\$ 3431.52	\$ 3613.49	\$4039.74
	14"(356mm)	36"(914mm)	UXML-1736-NSN	3150.39	3481.21	3670.87	4107.61	3387.89	3718.71	3908.37	4345.11
	14"(356mm)	42"(1067mm)	UXML-1742-NS	3421.59	3763.94	3961.29	4408.52	3680.76	4023.11	4220.46	4667.69
	14"(356mm)	48"(1219mm)	UXML-1748-NS	3675.58	4029.46	4234.50	4692.22	3956.42	4310.30	4515.34	4973.06
	14"(356mm)	54"(1372mm)	UXML-1754-NS	3929.57	4294.98	4507.71	4975.92	4232.08	4597.49	4810.22	5278.43
	14"(356mm)	60"(1524mm)	UXML-1760-NSN	4183.56	4560.50	4780.92	5259.62	4507.74	4884.68	5105.10	5583.80
	14"(356mm)	66"(1676mm)	UXML-1766-NSN	4437.55	4826.02	5054.13	5543.32	4783.40	5171.87	5399.98	5889.17
	14"(356mm)	72"(1829mm)	UXML-1772-NSN	4691.54	5091.54	5327.34	5827.02	5059.06	5459.06	5694.86	6194.54
	14"(356mm)	78"(1981mm)	UXML-1778-NSN	4962.74	5374.27	5617.76	6127.93	5351.93	5763.46	6006.95	6517.12
	14"(356mm)	84"(2134mm)	UXML-1784-NSN	5216.73	5639.79	5890.97	6411.63	5627.59	6050.65	6301.83	6822.49
	14"(356mm)	90"(2286mm)	UXML-1790-NSN	5470.72	5905.31	6164.18	6695.33	5903.25	6337.84	6596.71	7127.86
	14"(356mm)	96"(2438mm)	UXML-1796-NSN	5724.71	6170.83	6437.39	6979.03	6178.91	6625.03	6891.59	7433.23
Legal Depth											
16.56"(421mm)	16.5"(419mm)	30"(762mm)	UXMD-1730-NSN	\$ 3150.99	\$3470.28	\$3652.25	\$ 4078.50	\$3392.28	\$ 3711.57	\$ 3893.54	\$ 4319.79
	16.5"(419mm)	36"(914mm)	UXMD-1736-NSN	3404.98	3735.80	3925.46	4362.20	3667.94	3998.76	4188.42	4625.16
	16.5"(419mm)	42"(1067mm)	UXMD-1742-NS	3676.18	4018.53	4215.88	4663.11	3960.81	4303.16	4500.51	4947.74
	16.5"(419mm)	48"(1219mm)	UXMD-1748-NS	3930.17	4284.05	4489.09	4946.81	4236.47	4590.35	4795.39	5253.11
	16.5"(419mm)	54"(1372mm)	UXMD-1754-NS	4184.16	4549.57	4762.30	5230.51	4512.13	4877.54	5090.27	5558.48
	16.5"(419mm)	60"(1524mm)	UXMD-1760-NSN	4438.15	4815.09	5035.51	5514.21	4787.79	5164.73	5385.15	5863.85
	16.5"(419mm)	66"(1676mm)	UXMD-1766-NSN	4692.14	5080.61	5308.72	5797.91	5063.45	5451.92	5680.03	6169.22
	16.5"(419mm)	72"(1829mm)	UXMD-1772-NSN	4946.13	5346.13	5581.93	6081.61	5339.11	5739.11	5974.91	6474.59
	16.5"(419mm)	78"(1981mm)	UXMD-1778-NSN	5217.33	5628.86	5872.35	6382.52	5631.98	6043.51	6287.00	6797.17
	16.5"(419mm)	84"(2134mm)	UXMD-1784-NSN	5471.32	5894.38	6145.56	6666.22	5907.64	6330.70	6581.88	7102.54
	16.5"(419mm)	90"(2286mm)	UXMD-1790-NSN	5725.31	6159.90	6418.77	6949.92	6183.30	6617.89	6876.76	7407.91
	16.5"(419mm)	96"(2438mm)	UXMD-1796-NSN	5979.30	6425.42	6691.98	7233.62	6458.96	6905.08	7171.64	7713.28

Overhead Storage Unit

1.5H Glass Hinged Doors

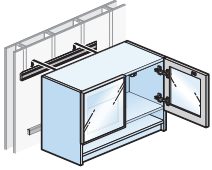

30" and 36" widths

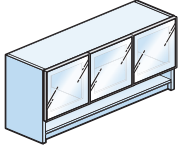

42"-54" widths

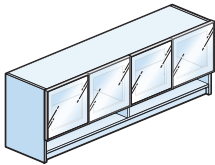

60"-72" widths

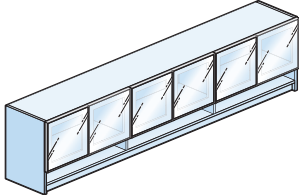

78"-96" widths

ULML-SN
 ULMD-SN
 UXML-SN
 UXMD-SN
 ULML-SL
 ULMD-SL
 UXML-SL
 UXMD-SL
 Class RA

Features

- Includes storage cabinet(s) with non-locking glass doors, 3.25"(83mm) cubbies, 2"(51mm) integrated light valance and 4"(102mm) French cleat with anti-dislodgement feature.
- 42"(1067mm), 48"(1219mm) and 54"(1372mm)W units available with choice of left or right door swing for single door.
- Locks not available.
- Glass door includes metal frame with metallic powdercoat finish on back side of door.
- Glass doors will be field installed.

Specification Tips

- Accommodates separately specified tackboards and lighting accessories.
- Must be properly anchored to a structural wall.
- Anchors are not provided, must be field supplied.

To Order, Specify:

- 1) Product number.
- 1 **Single Door Swing Orientation:**
 (42", 48" and 54"W only)
L Left-hand
R Right-hand
- 2) Finish code (laminate or wood).
- 3) Laminate edge trim color (if laminate specified).
- 4) Glass code.
- 5) Trim color for glass frame.

Overhead Storage Unit

1.5H Glass Hinged Doors

Height	Depth	Width	Number	①	HPL A Glass				HPL B Glass			
					A	C	D	H	A	C	D	H
Letter Depth												
21"(533mm)	14"(356mm)	30"(762mm)	ULML-2130-NSN		\$ 2376.23	\$ 2748.04	\$ 2964.97	\$ 3430.42	\$ 2445.30	\$ 2817.11	\$ 3034.04	\$ 3499.49
	14"(356mm)	36"(914mm)	ULML-2136-NSN		2566.61	2949.95	3174.57	3650.51	2648.15	3031.49	3256.11	3732.05
	14"(356mm)	42"(1067mm)	ULML-2142-NS		2774.20	3169.07	3401.38	3887.81	2868.21	3263.08	3495.39	3981.82
	14"(356mm)	48"(1219mm)	ULML-2148-NS		2964.58	3370.98	3610.98	4107.90	3071.06	3477.46	3717.46	4214.38
	14"(356mm)	54"(1372mm)	ULML-2154-NS		3154.96	3572.89	3820.58	4327.99	3273.91	3691.84	3939.53	4446.94
	14"(356mm)	60"(1524mm)	ULML-2160-NSN		3345.34	3774.80	4030.18	4548.08	3476.76	3906.22	4161.60	4679.50
	14"(356mm)	66"(1676mm)	ULML-2166-NSN		3535.72	3976.71	4239.78	4768.17	3679.61	4120.60	4383.67	4912.06
	14"(356mm)	72"(1829mm)	ULML-2172-NSN		3726.10	4178.62	4449.38	4988.26	3882.46	4334.98	4605.74	5144.62
	14"(356mm)	78"(1981mm)	ULML-2178-NSN		3933.69	4397.74	4676.19	5225.56	4102.52	4566.57	4845.02	5394.39
	14"(356mm)	84"(2134mm)	ULML-2184-NSN		4124.07	4599.65	4885.79	5445.65	4305.37	4780.95	5067.09	5626.95
	14"(356mm)	90"(2286mm)	ULML-2190-NSN		4314.45	4801.56	5095.39	5665.74	4508.22	4995.33	5289.16	5859.51
	14"(356mm)	96"(2438mm)	ULML-2196-NSN		4504.83	5003.47	5304.99	5885.83	4711.07	5209.71	5511.23	6092.07
Legal Depth												
21"(533mm)	16.5"(419mm)	30"(762mm)	ULMD-2130-NSN		\$ 2532.61	\$ 2904.42	\$ 3121.35	\$ 3586.80	\$ 2614.18	\$ 2985.99	\$ 3202.92	\$ 3668.37
	16.5"(419mm)	36"(914mm)	ULMD-2136-NSN		2722.99	3106.33	3330.95	3806.89	2817.03	3200.37	3424.99	3900.93
	16.5"(419mm)	42"(1067mm)	ULMD-2142-NS		2930.58	3325.45	3557.76	4044.19	3037.09	3431.96	3664.27	4150.70
	16.5"(419mm)	48"(1219mm)	ULMD-2148-NS		3120.96	3527.36	3767.36	4264.28	3239.94	3646.34	3886.34	4383.26
	16.5"(419mm)	54"(1372mm)	ULMD-2154-NS		3311.34	3729.27	3976.96	4484.37	3442.79	3860.72	4108.41	4615.82
	16.5"(419mm)	60"(1524mm)	ULMD-2160-NSN		3501.72	3931.18	4186.56	4704.46	3645.64	4075.10	4330.48	4848.38
	16.5"(419mm)	66"(1676mm)	ULMD-2166-NSN		3692.10	4133.09	4396.16	4924.55	3848.49	4289.48	4552.55	5080.94
	16.5"(419mm)	72"(1829mm)	ULMD-2172-NSN		3882.48	4335.00	4605.76	5144.64	4051.34	4503.86	4774.62	5313.50
	16.5"(419mm)	78"(1981mm)	ULMD-2178-NSN		4090.07	4554.12	4832.57	5381.94	4271.40	4735.45	5013.90	5563.27
	16.5"(419mm)	84"(2134mm)	ULMD-2184-NSN		4280.45	4756.03	5042.17	5602.03	4474.25	4949.83	5235.97	5795.83
	16.5"(419mm)	90"(2286mm)	ULMD-2190-NSN		4470.83	4957.94	5251.77	5822.12	4677.10	5164.21	5458.04	6028.39
	16.5"(419mm)	96"(2438mm)	ULMD-2196-NSN		4661.21	5159.85	5461.37	6042.21	4879.95	5378.59	5680.11	6260.95

Height	Depth	Width	Number	①	Wood A Glass				Wood B Glass			
					A	C	D	H	A	C	D	H
Letter Depth												
21"(533mm)	14"(356mm)	30"(762mm)	UXML-2130-NSN		\$ 3214.76	\$ 3586.57	\$ 3803.50	\$ 4268.95	\$ 3445.39	\$ 3817.20	\$ 4034.13	\$ 4499.58
	14"(356mm)	36"(914mm)	UXML-2136-NSN		3534.75	3918.09	4142.71	4618.65	3793.67	4177.01	4401.63	4877.57
	14"(356mm)	42"(1067mm)	UXML-2142-NS		3871.95	4266.82	4499.13	4985.56	4159.16	4554.03	4786.34	5272.77
	14"(356mm)	48"(1219mm)	UXML-2148-NS		4191.94	4598.34	4838.34	5335.26	4507.44	4913.84	5153.84	5650.76
	14"(356mm)	54"(1372mm)	UXML-2154-NS		4511.93	4929.86	5177.55	5684.96	4855.72	5273.65	5521.34	6028.75
	14"(356mm)	60"(1524mm)	UXML-2160-NSN		4831.92	5261.38	5516.76	6034.66	5204.00	5633.46	5888.84	6406.74
	14"(356mm)	66"(1676mm)	UXML-2166-NSN		5151.91	5592.90	5855.97	6384.36	5552.28	5993.27	6256.34	6784.73
	14"(356mm)	72"(1829mm)	UXML-2172-NSN		5471.90	5924.42	6195.18	6734.06	5900.56	6353.08	6623.84	7162.72
	14"(356mm)	78"(1981mm)	UXML-2178-NSN		5809.10	6273.15	6551.60	7100.97	6266.05	6730.10	7008.55	7557.92
	14"(356mm)	84"(2134mm)	UXML-2184-NSN		6129.09	6604.67	6890.81	7450.67	6614.33	7089.91	7376.05	7935.91
	14"(356mm)	90"(2286mm)	UXML-2190-NSN		6449.08	6936.19	7230.02	7800.37	6962.61	7449.72	7743.55	8313.90
	14"(356mm)	96"(2438mm)	UXML-2196-NSN		6769.07	7267.71	7569.23	8150.07	7310.89	7809.53	8111.05	8691.89
Legal Depth												
21"(533mm)	16.5"(419mm)	30"(762mm)	UXMD-2130-NSN		\$ 3469.35	\$ 3841.16	\$ 4058.09	\$ 4523.54	\$ 3725.44	\$ 4097.25	\$ 4314.18	\$ 4779.63
	16.5"(419mm)	36"(914mm)	UXMD-2136-NSN		3789.34	4172.68	4397.30	4873.24	4073.72	4457.06	4681.68	5157.62
	16.5"(419mm)	42"(1067mm)	UXMD-2142-NS		4126.54	4521.41	4753.72	5240.15	4439.21	4834.08	5066.39	5552.82
	16.5"(419mm)	48"(1219mm)	UXMD-2148-NS		4446.53	4852.93	5092.93	5589.85	4787.49	5193.89	5433.89	5930.81
	16.5"(419mm)	54"(1372mm)	UXMD-2154-NS		4766.52	5184.45	5432.14	5939.55	5135.77	5553.70	5801.39	6308.80
	16.5"(419mm)	60"(1524mm)	UXMD-2160-NSN		5086.51	5515.97	5771.35	6289.25	5484.05	5913.51	6168.89	6686.79
	16.5"(419mm)	66"(1676mm)	UXMD-2166-NSN		5406.50	5847.49	6110.56	6638.95	5832.33	6273.32	6536.39	7064.78
	16.5"(419mm)	72"(1829mm)	UXMD-2172-NSN		5726.49	6179.01	6449.77	6988.65	6180.61	6633.13	6903.89	7442.77
	16.5"(419mm)	78"(1981mm)	UXMD-2178-NSN		6063.69	6527.74	6806.19	7355.56	6546.10	7010.15	7288.60	7837.97
	16.5"(419mm)	84"(2134mm)	UXMD-2184-NSN		6383.68	6859.26	7145.40	7705.26	6894.38	7369.96	7656.10	8215.96
	16.5"(419mm)	90"(2286mm)	UXMD-2190-NSN		6703.67	7190.78	7484.61	8054.96	7242.66	7729.77	8023.60	8593.95
	16.5"(419mm)	96"(2438mm)	UXMD-2196-NSN		7023.66	7522.30	7823.82	8404.66	7590.94	8089.58	8391.10	8971.94

Overhead Storage Unit

2H Glass Hinged Doors

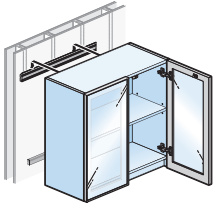

30" and 36" widths
ULML-SN
ULMD-SN
UXML-SN
UXMD-SN

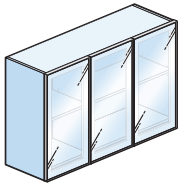

42"-54" widths
ULML-SL
ULMD-SL
UXML-SL
UXMD-SL

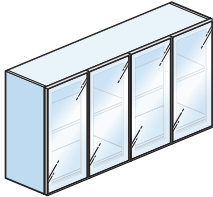

60"-72" widths
ULML-SN
ULMD-SN
UXML-SN
UXMD-SN

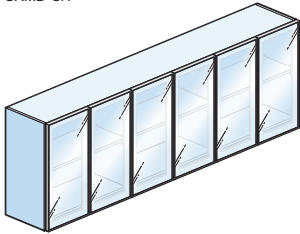

78"-96" widths
ULML-SN
ULMD-SN
UXML-SN
UXMD-SN
Class RA

Features

- Includes storage cabinet(s) with glass doors, 2"(51mm) integrated light valance, one adjustable shelf and 4"(102mm) French cleat with anti-dislodgement feature.
- 42"(1067mm), 48"(1219mm) and 54"(1372mm)W units available with choice of left or right door swing for single door.
- One interior .75"(19mm) thick wood shelf with ±1.25"(32mm) adjustment range.
- Locks not available.
- Glass door includes metal frame with metallic powdercoat finish on back side of door.
- Glass doors will be field installed.

Specification Tips

- Accommodates separately specified tackboards and lighting accessories.
- Must be properly anchored to a structural wall.
- Anchors are not provided, must be field supplied.

To Order, Specify:

- 1) Product number.
- 1 **Single Door Swing Orientation:**
(42", 48" and 54"W only)
L Left-hand
R Right-hand
- 2) Finish code (laminate or wood).
- 3) Laminate edge trim color (if laminate specified).
- 4) Glass code.
- 5) Trim color for glass frame.

Overhead Storage Unit

2H Glass Hinged Doors

Height	Depth	Width	Number	①	HPL A Glass				HPL B Glass			
					A	C	D	H	A	C	D	H
Letter Depth												
29.125"(740mm)	14"(356mm)	30"(762mm)	ULML-2930-NSN		\$ 2877.51	\$ 3354.36	\$ 3641.21	\$ 4185.06	\$2959.62	\$3436.47	\$ 3723.32	\$ 4267.17
	14"(356mm)	36"(914mm)	ULML-2936-NSN		3067.89	3556.27	3850.81	4405.15	3162.47	3650.85	3945.39	4499.73
	14"(356mm)	42"(1067mm)	ULML-2942-NS		3275.48	3775.39	4077.62	4642.45	3382.53	3882.44	4184.67	4749.50
	14"(356mm)	48"(1219mm)	ULML-2948-NS		3465.86	3977.30	4287.22	4862.54	3585.38	4096.82	4406.74	4982.06
	14"(356mm)	54"(1372mm)	ULML-2954-NS		3656.24	4179.21	4496.82	5082.63	3788.23	4311.20	4628.81	5214.62
	14"(356mm)	60"(1524mm)	ULML-2960-NSN		3846.62	4381.12	4706.42	5302.72	3991.08	4525.58	4850.88	5447.18
	14"(356mm)	66"(1676mm)	ULML-2966-NSN		4037.00	4583.03	4916.02	5522.81	4193.93	4739.96	5072.95	5679.74
	14"(356mm)	72"(1829mm)	ULML-2972-NSN		4227.38	4784.94	5125.62	5742.90	4396.78	4954.34	5295.02	5912.30
	14"(356mm)	78"(1981mm)	ULML-2978-NSN		4434.97	5004.06	5352.43	5980.20	4616.84	5185.93	5534.30	6162.07
	14"(356mm)	84"(2134mm)	ULML-2984-NSN		4625.35	5205.97	5562.03	6200.29	4819.69	5400.31	5756.37	6394.63
	14"(356mm)	90"(2286mm)	ULML-2990-NSN		4815.73	5407.88	5771.63	6420.38	5022.54	5614.69	5978.44	6627.19
	14"(356mm)	96"(2438mm)	ULML-2996-NSN		5006.11	5609.79	5981.23	6640.47	5225.39	5829.07	6200.51	6859.75
Legal Depth												
29.125"(740mm)	16.5"(419mm)	30"(762mm)	ULMD-2930-NSN		\$ 3033.89	\$ 3510.74	\$ 3797.59	\$ 4341.44	\$ 3128.50	\$3605.35	\$ 3892.20	\$4436.05
	16.5"(419mm)	36"(914mm)	ULMD-2936-NSN		3224.27	3712.65	4007.19	4561.53	3331.35	3819.73	4114.27	4668.61
	16.5"(419mm)	42"(1067mm)	ULMD-2942-NS		3431.86	3931.77	4234.00	4798.83	3551.41	4051.32	4353.55	4918.38
	16.5"(419mm)	48"(1219mm)	ULMD-2948-NS		3622.24	4133.68	4443.60	5018.92	3754.26	4265.70	4575.62	5150.94
	16.5"(419mm)	54"(1372mm)	ULMD-2954-NS		3812.62	4335.59	4653.20	5239.01	3957.11	4480.08	4797.69	5383.50
	16.5"(419mm)	60"(1524mm)	ULMD-2960-NSN		4003.00	4537.50	4862.80	5459.10	4159.96	4694.46	5019.76	5616.06
	16.5"(419mm)	66"(1676mm)	ULMD-2966-NSN		4193.38	4739.41	5072.40	5679.19	4362.81	4908.84	5241.83	5848.62
	16.5"(419mm)	72"(1829mm)	ULMD-2972-NSN		4383.76	4941.32	5282.00	5899.28	4565.66	5123.22	5463.90	6081.18
	16.5"(419mm)	78"(1981mm)	ULMD-2978-NSN		4591.35	5160.44	5508.81	6136.58	4785.72	5354.81	5703.18	6330.95
	16.5"(419mm)	84"(2134mm)	ULMD-2984-NSN		4781.73	5362.35	5718.41	6356.67	4988.57	5569.19	5925.25	6563.51
	16.5"(419mm)	90"(2286mm)	ULMD-2990-NSN		4972.11	5564.26	5928.01	6576.76	5191.42	5783.57	6147.32	6796.07
	16.5"(419mm)	96"(2438mm)	ULMD-2996-NSN		5162.49	5766.17	6137.61	6796.85	5394.27	5997.95	6369.39	7028.63

Height	Depth	Width	Number	①	Wood A Glass				Wood B Glass			
					A	C	D	H	A	C	D	H
Letter Depth												
29.125"(740mm)	14"(356mm)	30"(762mm)	UXML-2930-NSN		\$ 3851.48	\$ 4328.33	\$ 4615.18	\$ 5159.03	\$ 4111.71	\$4588.56	\$ 4875.41	\$ 5419.26
	14"(356mm)	36"(914mm)	UXML-2936-NSN		4171.47	4659.85	4954.39	5508.73	4459.99	4948.37	5242.91	5797.25
	14"(356mm)	42"(1067mm)	UXML-2942-NS		4508.67	5008.58	5310.81	5875.64	4825.48	5325.39	5627.62	6192.45
	14"(356mm)	48"(1219mm)	UXML-2948-NS		4828.66	5340.10	5650.02	6225.34	5173.76	5685.20	5995.12	6570.44
	14"(356mm)	54"(1372mm)	UXML-2954-NS		5148.65	5671.62	5989.23	6575.04	5522.04	6045.01	6362.62	6948.43
	14"(356mm)	60"(1524mm)	UXML-2960-NSN		5468.64	6003.14	6328.44	6924.74	5870.32	6404.82	6730.12	7326.42
	14"(356mm)	66"(1676mm)	UXML-2966-NSN		5788.63	6334.66	6667.65	7274.44	6218.60	6764.63	7097.62	7704.41
	14"(356mm)	72"(1829mm)	UXML-2972-NSN		6108.62	6666.18	7006.86	7624.14	6566.88	7124.44	7465.12	8082.40
	14"(356mm)	78"(1981mm)	UXML-2978-NSN		6445.82	7014.91	7363.28	7991.05	6932.37	7501.46	7849.83	8477.60
	14"(356mm)	84"(2134mm)	UXML-2984-NSN		6765.81	7346.43	7702.49	8340.75	7280.65	7861.27	8217.33	8855.59
	14"(356mm)	90"(2286mm)	UXML-2990-NSN		7085.80	7677.95	8041.70	8690.45	7628.93	8221.08	8584.83	9233.58
	14"(356mm)	96"(2438mm)	UXML-2996-NSN		7405.79	8009.47	8380.91	9040.15	7977.21	8580.89	8952.33	9611.57
Legal Depth												
29.125"(740mm)	16.5"(419mm)	30"(762mm)	UXMD-2930-NSN		\$ 4106.07	\$ 4582.92	\$ 4869.77	\$ 5413.62	\$ 4391.76	\$4868.61	\$ 5155.46	\$5699.31
	16.5"(419mm)	36"(914mm)	UXMD-2936-NSN		4426.06	4914.44	5208.98	5763.32	4740.04	5228.42	5522.96	6077.30
	16.5"(419mm)	42"(1067mm)	UXMD-2942-NS		4763.26	5263.17	5565.40	6130.23	5105.53	5605.44	5907.67	6472.50
	16.5"(419mm)	48"(1219mm)	UXMD-2948-NS		5083.25	5594.69	5904.61	6479.93	5453.81	5965.25	6275.17	6850.49
	16.5"(419mm)	54"(1372mm)	UXMD-2954-NS		5403.24	5926.21	6243.82	6829.63	5802.09	6325.06	6642.67	7228.48
	16.5"(419mm)	60"(1524mm)	UXMD-2960-NSN		5723.23	6257.73	6583.03	7179.33	6150.37	6684.87	7010.17	7606.47
	16.5"(419mm)	66"(1676mm)	UXMD-2966-NSN		6043.22	6589.25	6922.24	7529.03	6498.65	7044.68	7377.67	7984.46
	16.5"(419mm)	72"(1829mm)	UXMD-2972-NSN		6363.21	6920.77	7261.45	7878.73	6846.93	7404.49	7745.17	8362.45
	16.5"(419mm)	78"(1981mm)	UXMD-2978-NSN		6700.41	7269.50	7617.87	8245.64	7212.42	7781.51	8129.88	8757.65
	16.5"(419mm)	84"(2134mm)	UXMD-2984-NSN		7020.40	7601.02	7957.08	8595.34	7560.70	8141.32	8497.38	9135.64
	16.5"(419mm)	90"(2286mm)	UXMD-2990-NSN		7340.39	7932.54	8296.29	8945.04	7908.98	8501.13	8864.88	9513.63
	16.5"(419mm)	96"(2438mm)	UXMD-2996-NSN		7660.38	8264.06	8635.50	9294.74	8257.26	8860.94	9232.38	9891.62

Overhead Storage Unit

1H Glass Sliding Door

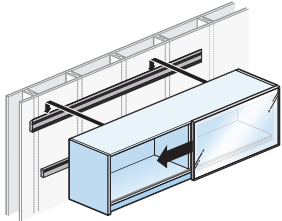

30"-72" widths

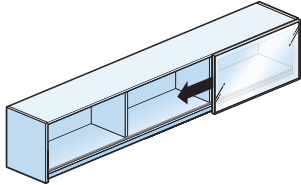

78"-96" widths
 ULLL-SN
 ULLD-SN
 UXLL-SN
 UXLD-SN
 Class RA

Features

- Includes storage cabinet(s) with one glass sliding door, 2"(51mm) integrated light valance and 4"(102mm) French cleat with anti-dislodgement feature.
- Units 30"-72"(762mm-1829mm)W include two equal width sections divided by one inset intermediate center support.
- Units 78"-96"(1981mm-2438mm)W include three equal width sections divided by two inset intermediate center supports.
- Sliding door width equal to one section width (one-half or one-third of unit width).
- Locks not available.
- Glass door includes metal frame with metallic powdercoat finish on back side of door.
- Includes internally mounted sliding door track top and bottom with bumpers at each end.
- Glass doors will be field installed.

Specification Tips

- Accommodates separately specified tackboards and lighting accessories.
- Must be properly anchored to a structural wall.
- Anchors are not provided, must be field supplied.
- Only back-painted glass available as standard; specifying alternate glass may allow for the light valance and hardware to be visible.

To Order, Specify:

- 1) Product number.
- 2) Finish code (laminated or wood).
- 3) Laminate edge trim color (if laminate specified).
- 4) Glass code.
- 5) Trim color for glass frame.

Overhead Storage Unit

1H Glass Sliding Door

Height	Depth	Width	Number	HPL A Glass				HPL B Glass			
				A	C	D	H	A	C	D	H
Letter Depth											
16.56"(421mm)	14"(356mm)	30"(762mm)	ULLL-1730-NSN	\$ 1709.17	\$ 1890.26	\$ 2011.11	\$ 2176.02	\$ 1771.72	\$ 1952.81	\$ 2073.66	\$ 2238.57
	14"(356mm)	36"(914mm)	ULLL-1736-NSN	1858.28	2049.22	2176.68	2350.56	1930.20	2121.14	2248.60	2422.48
	14"(356mm)	42"(1067mm)	ULLL-1742-NSN	2024.60	2225.39	2359.46	2542.31	2105.89	2306.68	2440.75	2623.60
	14"(356mm)	48"(1219mm)	ULLL-1748-NSN	2173.71	2384.35	2525.03	2716.85	2264.37	2475.01	2615.69	2807.51
	14"(356mm)	54"(1372mm)	ULLL-1754-NSN	2322.82	2543.31	2690.60	2891.39	2422.85	2643.34	2790.63	2991.42
	14"(356mm)	60"(1524mm)	ULLL-1760-NSN	2471.93	2702.27	2856.17	3065.93	2581.33	2811.67	2965.57	3175.33
	14"(356mm)	66"(1676mm)	ULLL-1766-NSN	2621.04	2861.23	3021.74	3240.47	2739.81	2980.00	3140.51	3359.24
	14"(356mm)	72"(1829mm)	ULLL-1772-NSN	2770.15	3020.19	3187.31	3415.01	2898.28	3148.33	3315.45	3543.15
	14"(356mm)	78"(1981mm)	ULLL-1778-NSN	2936.47	3196.36	3370.09	3606.76	3073.98	3333.87	3507.60	3744.27
	14"(356mm)	84"(2134mm)	ULLL-1784-NSN	3085.58	3355.32	3535.66	3781.30	3232.46	3502.20	3682.54	3928.18
	14"(356mm)	90"(2286mm)	ULLL-1790-NSN	3234.69	3514.28	3701.23	3955.84	3390.94	3670.53	3857.48	4112.09
	14"(356mm)	96"(2438mm)	ULLL-1796-NSN	3383.80	3673.24	3866.80	4130.38	3549.42	3838.86	4032.42	4296.00
Legal Depth											
16.56"(421mm)	16.5"(419mm)	30"(762mm)	ULLD-1730-NSN	\$ 1865.55	\$ 2046.64	\$ 2167.49	\$ 2332.40	\$ 1940.60	\$ 2121.69	\$ 2242.54	\$ 2407.45
	16.5"(419mm)	36"(914mm)	ULLD-1736-NSN	2014.66	2205.60	2333.06	2506.94	2099.08	2290.02	2417.48	2591.36
	16.5"(419mm)	42"(1067mm)	ULLD-1742-NSN	2180.98	2381.77	2515.84	2698.69	2274.77	2475.56	2609.63	2792.48
	16.5"(419mm)	48"(1219mm)	ULLD-1748-NSN	2330.09	2540.73	2681.41	2873.23	2433.25	2643.89	2784.57	2976.39
	16.5"(419mm)	54"(1372mm)	ULLD-1754-NSN	2479.20	2699.69	2846.98	3047.77	2591.73	2812.22	2959.51	3160.30
	16.5"(419mm)	60"(1524mm)	ULLD-1760-NSN	2628.31	2858.65	3012.55	3222.31	2750.21	2980.55	3134.45	3344.21
	16.5"(419mm)	66"(1676mm)	ULLD-1766-NSN	2777.42	3017.61	3178.12	3396.85	2908.69	3148.88	3309.39	3528.12
	16.5"(419mm)	72"(1829mm)	ULLD-1772-NSN	2926.53	3176.57	3343.69	3571.39	3067.17	3317.21	3484.33	3712.03
	16.5"(419mm)	78"(1981mm)	ULLD-1778-NSN	3092.85	3352.74	3526.47	3763.14	3242.86	3502.75	3676.48	3913.15
	16.5"(419mm)	84"(2134mm)	ULLD-1784-NSN	3241.96	3511.70	3692.04	3937.68	3401.34	3671.08	3851.42	4097.06
	16.5"(419mm)	90"(2286mm)	ULLD-1790-NSN	3391.07	3670.66	3857.61	4112.22	3559.82	3839.41	4026.36	4280.97
	16.5"(419mm)	96"(2438mm)	ULLD-1796-NSN	3540.18	3829.62	4023.18	4286.76	3718.30	4007.74	4201.30	4464.88

Height	Depth	Width	Number	Wood A Glass				Wood B Glass			
				A	C	D	H	A	C	D	H
Letter Depth											
16.56"(421mm)	14"(356mm)	30"(762mm)	UXLL-1730-NSN	\$ 2479.98	\$ 2661.07	\$ 2781.92	\$ 2946.83	\$ 2695.81	\$ 2876.90	\$ 2997.75	\$ 3162.66
	14"(356mm)	36"(914mm)	UXLL-1736-NSN	2728.69	2919.63	3047.09	3220.97	2966.19	3157.13	3284.59	3458.47
	14"(356mm)	42"(1067mm)	UXLL-1742-NSN	2994.61	3195.40	3329.47	3512.32	3253.78	3454.57	3588.64	3771.49
	14"(356mm)	48"(1219mm)	UXLL-1748-NSN	3243.32	3453.96	3594.64	3786.46	3524.16	3734.80	3875.48	4067.30
	14"(356mm)	54"(1372mm)	UXLL-1754-NSN	3492.03	3712.52	3859.81	4060.60	3794.54	4015.03	4162.32	4363.11
	14"(356mm)	60"(1524mm)	UXLL-1760-NSN	3740.74	3971.08	4124.98	4334.74	4064.92	4295.26	4449.16	4658.92
	14"(356mm)	66"(1676mm)	UXLL-1766-NSN	3989.45	4229.64	4390.15	4608.88	4335.30	4575.49	4736.00	4954.73
	14"(356mm)	72"(1829mm)	UXLL-1772-NSN	4238.16	4488.20	4655.32	4883.02	4605.68	4855.72	5022.84	5250.54
	14"(356mm)	78"(1981mm)	UXLL-1778-NSN	4504.08	4763.97	4937.70	5174.37	4893.27	5153.16	5326.89	5563.56
	14"(356mm)	84"(2134mm)	UXLL-1784-NSN	4752.79	5022.53	5202.87	5448.51	5163.65	5433.39	5613.73	5859.37
	14"(356mm)	90"(2286mm)	UXLL-1790-NSN	5001.50	5281.09	5468.04	5722.65	5434.03	5713.62	5900.57	6155.18
	14"(356mm)	96"(2438mm)	UXLL-1796-NSN	5250.21	5539.65	5733.21	5996.79	5704.41	5993.85	6187.41	6450.99
Legal Depth											
16.56"(421mm)	16.5"(419mm)	30"(762mm)	UXLD-1730-NSN	\$ 2734.57	\$ 2915.66	\$ 3036.51	\$ 3201.42	\$ 2975.86	\$ 3156.95	\$ 3277.80	\$ 3442.71
	16.5"(419mm)	36"(914mm)	UXLD-1736-NSN	2983.28	3174.22	3301.68	3475.56	3246.24	3437.18	3564.64	3738.52
	16.5"(419mm)	42"(1067mm)	UXLD-1742-NSN	3249.20	3449.99	3584.06	3766.91	3533.83	3734.62	3868.69	4051.54
	16.5"(419mm)	48"(1219mm)	UXLD-1748-NSN	3497.91	3708.55	3849.23	4041.05	3804.21	4014.85	4155.53	4347.35
	16.5"(419mm)	54"(1372mm)	UXLD-1754-NSN	3746.62	3967.11	4114.40	4315.19	4074.59	4295.08	4442.37	4643.16
	16.5"(419mm)	60"(1524mm)	UXLD-1760-NSN	3995.33	4225.67	4379.57	4589.33	4344.97	4575.31	4729.21	4938.97
	16.5"(419mm)	66"(1676mm)	UXLD-1766-NSN	4244.04	4484.23	4644.74	4863.47	4615.35	4855.54	5016.05	5234.78
	16.5"(419mm)	72"(1829mm)	UXLD-1772-NSN	4492.75	4742.79	4909.91	5137.61	4885.73	5135.77	5302.89	5530.59
	16.5"(419mm)	78"(1981mm)	UXLD-1778-NSN	4758.67	5018.56	5192.29	5428.96	5173.32	5433.21	5606.94	5843.61
	16.5"(419mm)	84"(2134mm)	UXLD-1784-NSN	5007.38	5277.12	5457.46	5703.10	5443.70	5713.44	5893.78	6139.42
	16.5"(419mm)	90"(2286mm)	UXLD-1790-NSN	5256.09	5535.68	5722.63	5977.24	5714.08	5993.67	6180.62	6435.23
	16.5"(419mm)	96"(2438mm)	UXLD-1796-NSN	5504.80	5794.24	5987.80	6251.38	5984.46	6273.90	6467.46	6731.04

Overhead Storage Unit

1.5H Glass Sliding Door

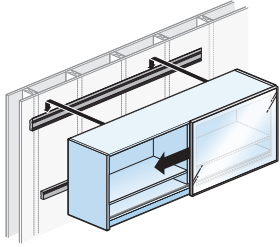

30"-72" widths

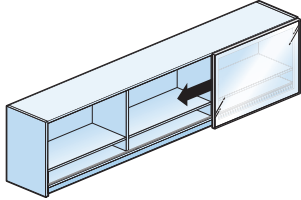

78"-96" widths
 ULLL-SN
 ULLD-SN
 UXLL-SN
 UXLD-SN
 Class RA

Features

- Includes storage cabinet(s) with one non-locking glass sliding door, 3.25" (83mm) cubbies, 2" (51mm) integrated light valance and 4" (102mm) French cleat with anti-dislodgement feature.
- Units 30"-72" (762mm-1829mm)W include two equal width sections divided by one inset intermediate center support.
- Units 78"-96" (1981mm-2438mm)W include three equal width sections divided by two inset intermediate center supports.
- Sliding door width equal to one section width (one-half or one-third of unit width).
- Locks not available.
- Glass door includes metal frame with metallic powdercoat finish on back side of door.
- Includes internally mounted sliding door track top and bottom with bumpers at each end.
- Glass doors will be field installed.

Specification Tips

- Accommodates separately specified tackboards and lighting accessories.
- Must be properly anchored to a structural wall.
- Anchors are not provided, must be field supplied.
- Only back-painted glass available as standard; specifying alternate glass may allow for the light valance and hardware to be visible.

To Order, Specify:

- 1) Product number.
- 2) Finish code (laminate or wood).
- 3) Laminate edge trim color (if laminate specified).
- 4) Glass code.
- 5) Trim color for glass frame.

Overhead Storage Unit

1.5H Glass Sliding Door

Height	Depth	Width	Number	HPL A Glass				HPL B Glass			
				A	C	D	H	A	C	D	H
Letter Depth											
21"(533mm)	14"(356mm)	30"(762mm)	ULLL-2130-NSN	\$ 1902.73	\$ 2118.58	\$ 2262.59	\$ 2459.14	\$ 1971.80	\$ 2187.65	\$ 2331.66	\$ 2528.21
	14"(356mm)	36"(914mm)	ULLL-2136-NSN	2087.83	2313.53	2464.15	2669.67	2169.37	2395.07	2545.69	2751.21
	14"(356mm)	42"(1067mm)	ULLL-2142-NSN	2290.14	2525.69	2682.92	2897.41	2384.15	2619.70	2776.93	2991.42
	14"(356mm)	48"(1219mm)	ULLL-2148-NSN	2475.24	2720.64	2884.48	3107.94	2581.72	2827.12	2990.96	3214.42
	14"(356mm)	54"(1372mm)	ULLL-2154-NSN	2660.34	2915.59	3086.04	3318.47	2779.29	3034.54	3204.99	3437.42
	14"(356mm)	60"(1524mm)	ULLL-2160-NSN	2845.44	3110.54	3287.60	3529.00	2976.86	3241.96	3419.02	3660.42
	14"(356mm)	66"(1676mm)	ULLL-2166-NSN	3030.54	3305.49	3489.16	3739.53	3174.43	3449.38	3633.05	3883.42
	14"(356mm)	72"(1829mm)	ULLL-2172-NSN	3215.64	3500.44	3690.72	3950.06	3372.00	3656.80	3847.08	4106.42
	14"(356mm)	78"(1981mm)	ULLL-2178-NSN	3417.95	3712.60	3909.49	4177.80	3586.78	3881.43	4078.32	4346.63
	14"(356mm)	84"(2134mm)	ULLL-2184-NSN	3603.05	3907.55	4111.05	4388.33	3784.35	4088.85	4292.35	4569.63
	14"(356mm)	90"(2286mm)	ULLL-2190-NSN	3788.15	4102.50	4312.61	4598.86	3981.92	4296.27	4506.38	4792.63
	14"(356mm)	96"(2438mm)	ULLL-2196-NSN	3973.25	4297.45	4514.17	4809.39	4179.49	4503.69	4720.41	5015.63
Legal Depth											
21"(533mm)	16.5"(419mm)	30"(762mm)	ULLD-2130-NSN	\$ 2059.11	\$ 2274.96	\$ 2418.97	\$ 2615.52	\$ 2140.68	\$ 2356.53	\$ 2500.54	\$ 2697.09
	16.5"(419mm)	36"(914mm)	ULLD-2136-NSN	2244.21	2469.91	2620.53	2826.05	2338.25	2563.95	2714.57	2920.09
	16.5"(419mm)	42"(1067mm)	ULLD-2142-NSN	2446.52	2682.07	2839.30	3053.79	2553.03	2788.58	2945.81	3160.30
	16.5"(419mm)	48"(1219mm)	ULLD-2148-NSN	2631.62	2877.02	3040.86	3264.32	2750.60	2996.00	3159.84	3383.30
	16.5"(419mm)	54"(1372mm)	ULLD-2154-NSN	2816.72	3071.97	3242.42	3474.85	2948.17	3203.42	3373.87	3606.30
	16.5"(419mm)	60"(1524mm)	ULLD-2160-NSN	3001.82	3266.92	3443.98	3685.38	3145.74	3410.84	3587.90	3829.30
	16.5"(419mm)	66"(1676mm)	ULLD-2166-NSN	3186.92	3461.87	3645.54	3895.91	3343.31	3618.26	3801.93	4052.30
	16.5"(419mm)	72"(1829mm)	ULLD-2172-NSN	3372.02	3656.82	3847.10	4106.44	3540.88	3825.68	4015.96	4275.30
	16.5"(419mm)	78"(1981mm)	ULLD-2178-NSN	3574.33	3868.98	4065.87	4334.18	3755.66	4050.31	4247.20	4515.51
	16.5"(419mm)	84"(2134mm)	ULLD-2184-NSN	3759.43	4063.93	4267.43	4544.71	3953.23	4257.73	4461.23	4738.51
	16.5"(419mm)	90"(2286mm)	ULLD-2190-NSN	3944.53	4258.88	4468.99	4755.24	4150.80	4465.15	4675.26	4961.51
	16.5"(419mm)	96"(2438mm)	ULLD-2196-NSN	4129.63	4453.83	4670.55	4965.77	4348.37	4672.57	4889.29	5184.51

Height	Depth	Width	Number	Wood A Glass				Wood B Glass			
				A	C	D	H	A	C	D	H
Letter Depth											
21"(533mm)	14"(356mm)	30"(762mm)	UXLL-2130-NSN	\$ 2741.26	\$ 2957.11	\$ 3101.12	\$ 3297.67	\$ 2971.89	\$ 3187.74	\$ 3331.75	\$ 3528.30
	14"(356mm)	36"(914mm)	UXLL-2136-NSN	3055.97	3281.67	3432.29	3637.81	3314.89	3540.59	3691.21	3896.73
	14"(356mm)	42"(1067mm)	UXLL-2142-NSN	3387.89	3623.44	3780.67	3995.16	3675.10	3910.65	4067.88	4282.37
	14"(356mm)	48"(1219mm)	UXLL-2148-NSN	3702.60	3948.00	4111.84	4335.30	4018.10	4263.50	4427.34	4650.80
	14"(356mm)	54"(1372mm)	UXLL-2154-NSN	4017.31	4272.56	4443.01	4675.44	4361.10	4616.35	4786.80	5019.23
	14"(356mm)	60"(1524mm)	UXLL-2160-NSN	4332.02	4597.12	4774.18	5015.58	4704.10	4969.20	5146.26	5387.66
	14"(356mm)	66"(1676mm)	UXLL-2166-NSN	4646.73	4921.68	5105.35	5355.72	5047.10	5322.05	5505.72	5756.09
	14"(356mm)	72"(1829mm)	UXLL-2172-NSN	4961.44	5246.24	5436.52	5695.86	5390.10	5674.90	5865.18	6124.52
	14"(356mm)	78"(1981mm)	UXLL-2178-NSN	5293.36	5588.01	5784.90	6053.21	5750.31	6044.96	6241.85	6510.16
	14"(356mm)	84"(2134mm)	UXLL-2184-NSN	5608.07	5912.57	6116.07	6393.35	6093.31	6397.81	6601.31	6878.59
	14"(356mm)	90"(2286mm)	UXLL-2190-NSN	5922.78	6237.13	6447.24	6733.49	6436.31	6750.66	6960.77	7247.02
	14"(356mm)	96"(2438mm)	UXLL-2196-NSN	6237.49	6561.69	6778.41	7073.63	6779.31	7103.51	7320.23	7615.45
Legal Depth											
21"(533mm)	16.5"(419mm)	30"(762mm)	UXLD-2130-NSN	\$ 2995.85	\$ 3211.70	\$ 3355.71	\$ 3552.26	\$ 3251.94	\$ 3467.79	\$ 3611.80	\$ 3808.35
	16.5"(419mm)	36"(914mm)	UXLD-2136-NSN	3310.56	3536.26	3686.88	3892.40	3594.94	3820.64	3971.26	4176.78
	16.5"(419mm)	42"(1067mm)	UXLD-2142-NSN	3642.48	3878.03	4035.26	4249.75	3955.15	4190.70	4347.93	4562.42
	16.5"(419mm)	48"(1219mm)	UXLD-2148-NSN	3957.19	4202.59	4366.43	4589.89	4298.15	4543.55	4707.39	4930.85
	16.5"(419mm)	54"(1372mm)	UXLD-2154-NSN	4271.90	4527.15	4697.60	4930.03	4641.15	4896.40	5066.85	5299.28
	16.5"(419mm)	60"(1524mm)	UXLD-2160-NSN	4586.61	4851.71	5028.77	5270.17	4984.15	5249.25	5426.31	5667.71
	16.5"(419mm)	66"(1676mm)	UXLD-2166-NSN	4901.32	5176.27	5359.94	5610.31	5327.15	5602.10	5785.77	6036.14
	16.5"(419mm)	72"(1829mm)	UXLD-2172-NSN	5216.03	5500.83	5691.11	5950.45	5670.15	5954.95	6145.23	6404.57
	16.5"(419mm)	78"(1981mm)	UXLD-2178-NSN	5547.95	5842.60	6039.49	6307.80	6030.36	6325.01	6521.90	6790.21
	16.5"(419mm)	84"(2134mm)	UXLD-2184-NSN	5862.66	6167.16	6370.66	6647.94	6373.36	6677.86	6881.36	7158.64
	16.5"(419mm)	90"(2286mm)	UXLD-2190-NSN	6177.37	6491.72	6701.83	6988.08	6716.36	7030.71	7240.82	7527.07
	16.5"(419mm)	96"(2438mm)	UXLD-2196-NSN	6492.08	6816.28	7033.00	7328.22	7059.36	7383.56	7600.28	7895.50

Overhead Storage Unit

2H Glass Sliding Door

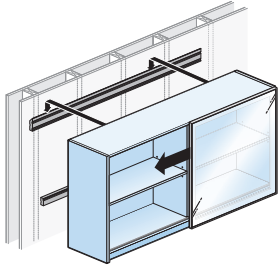

30"-72" widths

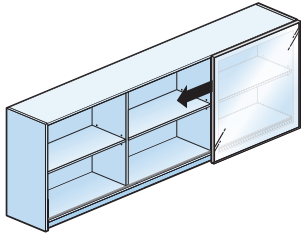

78"-96" widths
 ULLL-SN
 ULLD-SN
 UXLL-SN
 UXLD-SN
 Class RA

Features

- Includes storage cabinet(s) with one glass sliding door, 2"(51mm) integrated light valance, one adjustable shelf and 4"(102mm) French cleat with anti-dislodgement feature.
- Units 30"-72"(762mm-1829mm)W include two equal width sections divided by one inset intermediate center support.
- Units 78"-96"(1981mm-2438mm)W include three equal width sections divided by two inset intermediate center supports.
- Sliding door width equal to one section width (one-half or one-third of unit width).
- One interior .75"(19mm) thick wood shelf with ±1.25"(32mm) adjustment range.
- Locks not available.
- Glass door includes metal frame with metallic powdercoat finish on back side of door.
- Includes internally mounted sliding door track top and bottom with bumpers at each end.
- Glass doors will be field installed.

Specification Tips

- Accommodates separately specified tackboards and lighting accessories.
- Must be properly anchored to a structural wall.
- Anchors are not provided, must be field supplied.
- Only back-painted glass available as standard; specifying alternate glass may allow for the light valance and hardware to be visible.

To Order, Specify:

- 1) Product number.
- 2) Finish code (laminate or wood).
- 3) Laminate edge trim color (if laminate specified).
- 4) Glass code.
- 5) Trim color for glass frame.

Overhead Storage Unit

2H Glass Sliding Door

Height	Depth	Width	Number	HPL A Glass				HPL B Glass			
				A	C	D	H	A	C	D	H
Letter Depth											
29.125"(740mm)	14"(356mm)	30"(762mm)	ULLL-2930-NSN	\$ 2289.85	\$ 2575.22	\$ 2765.55	\$ 3025.38	\$ 2371.96	\$ 2657.33	\$ 2847.66	\$ 3107.49
	14"(356mm)	36"(914mm)	ULLL-2936-NSN	2474.95	2770.17	2967.11	3235.91	2569.53	2864.75	3061.69	3330.49
	14"(356mm)	42"(1067mm)	ULLL-2942-NSN	2677.26	2982.33	3185.88	3463.65	2784.31	3089.38	3292.93	3570.70
	14"(356mm)	48"(1219mm)	ULLL-2948-NSN	2862.36	3177.28	3387.44	3674.18	2981.88	3296.80	3506.96	3793.70
	14"(356mm)	54"(1372mm)	ULLL-2954-NSN	3047.46	3372.23	3589.00	3884.71	3179.45	3504.22	3720.99	4016.70
	14"(356mm)	60"(1524mm)	ULLL-2960-NSN	3232.56	3567.18	3790.56	4095.24	3377.02	3711.64	3935.02	4239.70
	14"(356mm)	66"(1676mm)	ULLL-2966-NSN	3417.66	3762.13	3992.12	4305.77	3574.59	3919.06	4149.05	4462.70
	14"(356mm)	72"(1829mm)	ULLL-2972-NSN	3602.76	3957.08	4193.68	4516.30	3772.16	4126.48	4363.08	4685.70
	14"(356mm)	78"(1981mm)	ULLL-2978-NSN	3805.07	4169.24	4412.45	4744.04	3986.94	4351.11	4594.32	4925.91
	14"(356mm)	84"(2134mm)	ULLL-2984-NSN	3990.17	4364.19	4614.01	4954.57	4184.51	4558.53	4808.35	5148.91
	14"(356mm)	90"(2286mm)	ULLL-2990-NSN	4175.27	4559.14	4815.57	5165.10	4382.08	4765.95	5022.38	5371.91
	14"(356mm)	96"(2438mm)	ULLL-2996-NSN	4360.37	4754.09	5017.13	5375.63	4579.65	4973.37	5236.41	5594.91
Legal Depth											
29.125"(740mm)	16.5"(419mm)	30"(762mm)	ULLD-2930-NSN	\$ 2446.23	\$ 2731.60	\$ 2921.93	\$ 3181.76	\$ 2540.84	\$ 2826.21	\$ 3016.54	\$ 3276.37
	16.5"(419mm)	36"(914mm)	ULLD-2936-NSN	2631.33	2926.55	3123.49	3392.29	2738.41	3033.63	3230.57	3499.37
	16.5"(419mm)	42"(1067mm)	ULLD-2942-NSN	2833.64	3138.71	3342.26	3620.03	2953.19	3258.26	3461.81	3739.58
	16.5"(419mm)	48"(1219mm)	ULLD-2948-NSN	3018.74	3333.66	3543.82	3830.56	3150.76	3465.68	3675.84	3962.58
	16.5"(419mm)	54"(1372mm)	ULLD-2954-NSN	3203.84	3528.61	3745.38	4041.09	3348.33	3673.10	3889.87	4185.58
	16.5"(419mm)	60"(1524mm)	ULLD-2960-NSN	3388.94	3723.56	3946.94	4251.62	3545.90	3880.52	4103.90	4408.58
	16.5"(419mm)	66"(1676mm)	ULLD-2966-NSN	3574.04	3918.51	4148.50	4462.15	3743.47	4087.94	4317.93	4631.58
	16.5"(419mm)	72"(1829mm)	ULLD-2972-NSN	3759.14	4113.46	4350.06	4672.68	3941.04	4295.36	4531.96	4854.58
	16.5"(419mm)	78"(1981mm)	ULLD-2978-NSN	3961.45	4325.62	4568.83	4900.42	4155.82	4519.99	4763.20	5094.79
	16.5"(419mm)	84"(2134mm)	ULLD-2984-NSN	4146.55	4520.57	4770.39	5110.95	4353.39	4727.41	4977.23	5317.79
	16.5"(419mm)	90"(2286mm)	ULLD-2990-NSN	4331.65	4715.52	4971.95	5321.48	4550.96	4934.83	5191.26	5540.79
	16.5"(419mm)	96"(2438mm)	ULLD-2996-NSN	4516.75	4910.47	5173.51	5532.01	4748.53	5142.25	5405.29	5763.79

Height	Depth	Width	Number	Wood A Glass				Wood B Glass			
				A	C	D	H	A	C	D	H
Letter Depth											
29.125"(740mm)	14"(356mm)	30"(762mm)	UXLL-2930-NSN	\$ 3263.82	\$ 3549.19	\$ 3739.52	\$ 3999.35	\$ 3524.05	\$ 3809.42	\$ 3999.75	\$ 4259.58
	14"(356mm)	36"(914mm)	UXLL-2936-NSN	3578.53	3873.75	4070.69	4339.49	3867.05	4162.27	4359.21	4628.01
	14"(356mm)	42"(1067mm)	UXLL-2942-NSN	3910.45	4215.52	4419.07	4696.84	4227.26	4532.33	4735.88	5013.65
	14"(356mm)	48"(1219mm)	UXLL-2948-NSN	4225.16	4540.08	4750.24	5036.98	4570.26	4885.18	5095.34	5382.08
	14"(356mm)	54"(1372mm)	UXLL-2954-NSN	4539.87	4864.64	5081.41	5377.12	4913.26	5238.03	5454.80	5750.51
	14"(356mm)	60"(1524mm)	UXLL-2960-NSN	4854.58	5189.20	5412.58	5717.26	5256.26	5590.88	5814.26	6118.94
	14"(356mm)	66"(1676mm)	UXLL-2966-NSN	5169.29	5513.76	5743.75	6057.40	5599.26	5943.73	6173.72	6487.37
	14"(356mm)	72"(1829mm)	UXLL-2972-NSN	5484.00	5838.32	6074.92	6397.54	5942.26	6296.58	6533.18	6855.80
	14"(356mm)	78"(1981mm)	UXLL-2978-NSN	5815.92	6180.09	6423.30	6754.89	6302.47	6666.64	6909.85	7241.44
	14"(356mm)	84"(2134mm)	UXLL-2984-NSN	6130.63	6504.65	6754.47	7095.03	6645.47	7019.49	7269.31	7609.87
	14"(356mm)	90"(2286mm)	UXLL-2990-NSN	6445.34	6829.21	7085.64	7435.17	6988.47	7372.34	7628.77	7978.30
	14"(356mm)	96"(2438mm)	UXLL-2996-NSN	6760.05	7153.77	7416.81	7775.31	7331.47	7725.19	7988.23	8346.73
Legal Depth											
29.125"(740mm)	16.5"(419mm)	30"(762mm)	UXLD-2930-NSN	\$ 3518.41	\$ 3803.78	\$ 3994.11	\$ 4253.94	\$ 3804.10	\$ 4089.47	\$ 4279.80	\$ 4539.63
	16.5"(419mm)	36"(914mm)	UXLD-2936-NSN	3833.12	4128.34	4325.28	4594.08	4147.10	4442.32	4639.26	4908.06
	16.5"(419mm)	42"(1067mm)	UXLD-2942-NSN	4165.04	4470.11	4673.66	4951.43	4507.31	4812.38	5015.93	5293.70
	16.5"(419mm)	48"(1219mm)	UXLD-2948-NSN	4479.75	4794.67	5004.83	5291.57	4850.31	5165.23	5375.39	5662.13
	16.5"(419mm)	54"(1372mm)	UXLD-2954-NSN	4794.46	5119.23	5336.00	5631.71	5193.31	5518.08	5734.85	6030.56
	16.5"(419mm)	60"(1524mm)	UXLD-2960-NSN	5109.17	5443.79	5667.17	5971.85	5536.31	5870.93	6094.31	6398.99
	16.5"(419mm)	66"(1676mm)	UXLD-2966-NSN	5423.88	5768.35	5998.34	6311.99	5879.31	6223.78	6453.77	6767.42
	16.5"(419mm)	72"(1829mm)	UXLD-2972-NSN	5738.59	6092.91	6329.51	6652.13	6222.31	6576.63	6813.23	7135.85
	16.5"(419mm)	78"(1981mm)	UXLD-2978-NSN	6070.51	6434.68	6677.89	7009.48	6582.52	6946.69	7189.90	7521.49
	16.5"(419mm)	84"(2134mm)	UXLD-2984-NSN	6385.22	6759.24	7009.06	7349.62	6925.52	7299.54	7549.36	7889.92
	16.5"(419mm)	90"(2286mm)	UXLD-2990-NSN	6699.93	7083.80	7340.23	7689.76	7268.52	7652.39	7908.82	8258.35
	16.5"(419mm)	96"(2438mm)	UXLD-2996-NSN	7014.64	7408.36	7671.40	8029.90	7611.52	8005.24	8268.28	8626.78

Overhead Storage Unit

Mounting Bracket to Enclose

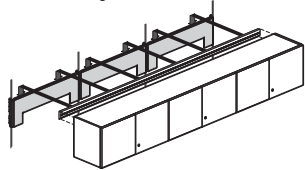
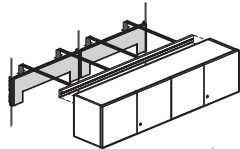
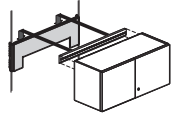
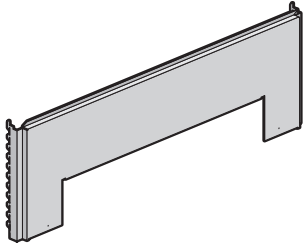

XWBB
Class RA

Features

- Includes black bracket and attachment hardware.
- One bracket for 30"(762mm)-48"(1219mm) Overhead Storage Unit. Two brackets for 54"(1372mm)-96"(2438mm) Overhead. Three brackets for 102"(2591mm)-108"(2743mm)

Specification Tips

- Designed to be used with 1H, 1.5H and 2H overhead storage units.
- Mounting Bracket is not for use with an Open Sided Shelf.
- Bracket width must match Enclose wall width for installation purposes.
- See matrix below for bracket quantity needed for Overhead Storage Unit size.

To Order, Specify:

- 1) Product number.
(No finish specification required.)

Overhead Storage Width	Bracket Number	Quantity of Brackets(s) Needed
30"(762mm)	XWBB-0030	1
36"(914mm)	XWBB-0036	1
42"(1067mm)	XWBB-0042	1
48"(1219mm)	XWBB-0048	1
54"(1372mm)	XWBB-0027	2
60"(1524mm)	XWBB-0030	2
66"(1676mm)	XWBB-0033	2
72"(1829mm)	XWBB-0036	2
78"(1981mm)	XWBB-0039	2
84"(2134mm)	XWBB-0042	2
90"(2286mm)	XWBB-0045	2
96"(2438mm)	XWBB-0048	2
102"(2591mm)*	XWBB-0034	3
108"(2743mm)*	XWBB-0036	3

Number	Price
XWBB-0027	\$48.70
XWBB-0030	48.70
XWBB-0033	48.70
XWBB-0034	48.70
XWBB-0036	48.70
XWBB-0039	51.64
XWBB-0042	51.64
XWBB-0045	51.64
XWBB-0048	51.64

Stack-On Bookcase

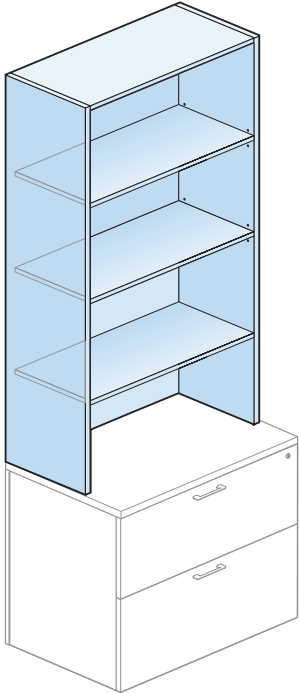
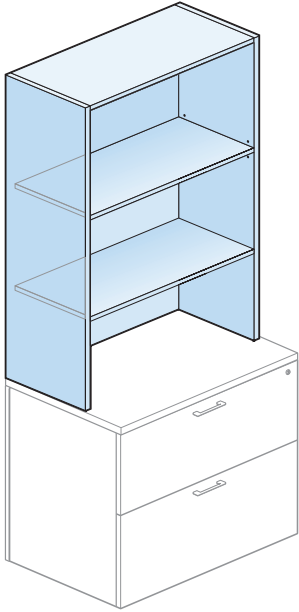

X4KL-SN
 X4KD-SN
 X6KL-SN
 X6KD-SN
 Class RA

Features

- Includes unfinished back, one fixed shelf, attachment material and one adjustable shelf for 3H or two adjustable shelves for 4H unit.
- Adjustable .75" (19mm) thick shelf has ±1.25" (32mm) adjustment range.
- Bottom shelf is fixed.
- Shipped assembled.

Specification Tips

- Not for use on a freestanding or standalone desk.
- Predrilled shelf locations do not align with adjacent wall mounted upper storage components.
- 40" (1016mm)H aligns with 5H storage units when stacked on top of 2H storage.
- 52" (1321mm)H aligns with 6H storage units when stacked on top of 2H storage.
- See Stack-on Application Rules in Specification Guide.
- Wood units are not designed for applications where the back of the unit is visible.

To Order, Specify:

- 1) Product number.
- 2) Finish code (lamine or wood).
- 3) Lamine edge trim color (if lamine specified).

Stack-On Bookcase

Nominal Height	Actual Height	Depth	Width	Number	HPL		Wood	
					A	B	A	B
HPL — Letter Depth								
40"(1016mm)	39.9"(1013mm)	14"(356mm)	30"(762mm)	X5KL-4030-NNSN	\$ 1974.13	\$ 2106.05		
		14"(356mm)	36"(914mm)	X5KL-4036-NNSN	2048.80	2182.54		
52"(1321mm)	52.5"(1334mm)	14"(356mm)	30"(762mm)	X5KL-5230-NNSN	\$ 2697.42	\$ 2830.64		
		14"(356mm)	36"(914mm)	X5KL-5236-NNSN	2795.31	2930.35		
HPL — Legal Depth								
40"(1016mm)	39.9"(1013mm)	16.5"(419mm)	30"(762mm)	X5KD-4030-NNSN	\$ 2023.89	\$ 2155.81		
		16.5"(419mm)	36"(914mm)	X5KD-4036-NNSN	2098.56	2232.30		
52"(1321mm)	52.5"(1334mm)	16.5"(419mm)	30"(762mm)	X5KD-5230-NNSN	\$ 2763.76	\$ 2896.98		
		16.5"(419mm)	36"(914mm)	X5KD-5236-NNSN	2861.65	2996.69		
Wood — Letter Depth								
40"(1016mm)	39.9"(1013mm)	14"(356mm)	30"(762mm)	X4KL-4030-NNSN			\$ 3014.66	\$ 3361.49
		14"(356mm)	36"(914mm)	X4KL-4036-NNSN			3089.33	3446.17
52"(1321mm)	52.5"(1334mm)	14"(356mm)	30"(762mm)	X4KL-5230-NNSN			\$ 3896.01	\$ 4345.85
		14"(356mm)	36"(914mm)	X4KL-5236-NNSN			3993.90	4453.75
Wood — Legal Depth								
40"(1016mm)	39.9"(1013mm)	16.5"(419mm)	30"(762mm)	X4KD-4030-NNSN			\$ 3064.42	\$ 3411.25
		16.5"(419mm)	36"(914mm)	X4KD-4036-NNSN			3139.09	3495.93
52"(1321mm)	52.5"(1334mm)	16.5"(419mm)	30"(762mm)	X4KD-5230-NNSN			\$ 3962.35	\$ 4412.19
		16.5"(419mm)	36"(914mm)	X4KD-5236-NNSN			4060.24	4520.09

Stack-On Storage Cabinet

Hinged Doors

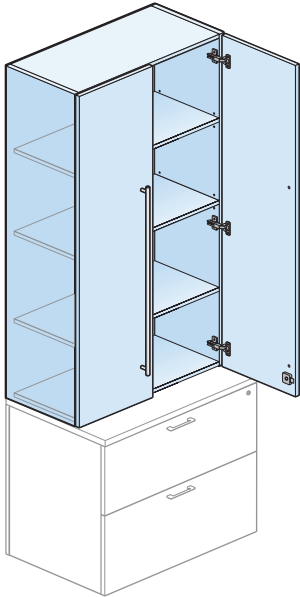
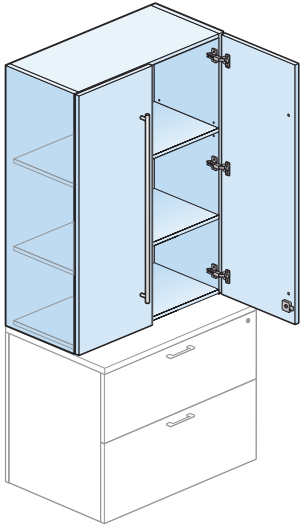

X4CL-SW
 X4CD-SW
 X5CL-SW
 X5CD-SW
 Class RA

Features

- Includes unfinished back, hinged doors with concealed hinges, attachment material, two adjustable shelves for 3H or three adjustable shelves for 4H unit.
- Adjustable .75"(19mm) thick shelf has ±1.25"(32mm) adjustment range.
- Door pull options:
 - Bar and Wing pulls available in powdercoat.
 - Linear pulls available in both powdercoat finish and satin nickel. Satin nickel will need to be specified.
 - Classic pulls are available in brushed nickel finish only. Finish code not required.
 - Touch latch option, available with Walnut double cut and Wood Group B finishes, indicates a door equipped with a touch latch.
- Optional lock available; lock plug available in black or chrome.
- For lock options, refer to Lock Program section of the Accessories Price List.
- Shipped assembled.

Specification Tips

- Not for use on a freestanding pedestal desk or desk shell.
- 40"(1016mm)H nominal aligns with 5H storage units when stacked on top of 2H storage.
- 52"(1321mm)H aligns with 6H storage units when stacked on top of 2H storage.
- See Stack-on Application Rules in Specification Guide.
- Wood units are not designed for application where the back of unit is visible.

To Order, Specify:

1) Product number, including:

1 Pull Option:





- F** Touch latch
- B** Bar (add **\$85.00** list)
- 8** Linear
- 9** Classic
- W** Wing (add **\$30.00** list)

2 Lock Option:

- N** No Lock
- L** Lock (add **\$177.50** list)

- 2) Finish code (laminate or wood).
- 3) Laminate edge trim color (if laminate specified).
- 4) Trim color for painted pull (if specified).
- 5) Trim color for lock (if specified).

1 Pull Styles

	
F Touch latch	B Bar
	
8 Linear	9 Classic
	
W Wing	

Stack-On Storage Cabinet

Hinged Doors

Nomial Height	Actual Height	Depth	Width	Number ① ②	HPL		Wood	
					A	B	A	B
HPL — Letter Depth								
40"(1016mm)	39.875"(1013mm)	14"(356mm)	30"(762mm)	X5CL-4030-	SL	\$ 2615.98	\$2786.74	
		14"(356mm)	36"(914mm)	X5CL-4036-	SL	2711.39	2882.15	
52"(1321mm)	52.5"(1334mm)	14"(356mm)	30"(762mm)	X5CL-5230-	SL	\$3569.05	\$3739.81	
		14"(356mm)	36"(914mm)	X5CL-5236-	SL	3664.46	3835.22	
HPL — Legal Depth								
40"(1016mm)	39.875"(1013mm)	16.5"(419mm)	30"(762mm)	X5CD-4030-	SL	\$2698.92	\$2869.68	
		16.5"(419mm)	36"(914mm)	X5CD-4036-	SL	2794.33	2965.09	
52"(1321mm)	52.5"(1334mm)	16.5"(419mm)	30"(762mm)	X5CD-5230-	SL	\$ 3651.99	\$3822.75	
		16.5"(419mm)	36"(914mm)	X5CD-5236-	SL	3747.40	3918.16	
Wood — Letter Depth								
40"(1016mm)	39.875"(1013mm)	14"(356mm)	30"(762mm)	X4CL-4030-	SW		\$4038.94	\$4509.76
		14"(356mm)	36"(914mm)	X4CL-4036-	SW		4134.35	4616.67
52"(1321mm)	52.5"(1334mm)	14"(356mm)	30"(762mm)	X4CL-5230-	SW		\$4992.01	\$ 5577.76
		14"(356mm)	36"(914mm)	X4CL-5236-	SW		5087.42	5684.67
Wood — Legal Depth								
40"(1016mm)	39.875"(1013mm)	16.5"(419mm)	30"(762mm)	X4CD-4030-	SW	\$ 4121.88	\$4592.70	
		16.5"(419mm)	36"(914mm)	X4CD-4036-	SW		4217.29	4699.61
52"(1321mm)	52.5"(1334mm)	16.5"(419mm)	30"(762mm)	X4CD-5230-	SW	\$ 5074.95	\$5660.70	
		16.5"(419mm)	36"(914mm)	X4CD-5236-	SW		5170.36	5767.61

Stack-On Storage Cabinet

Glass Doors

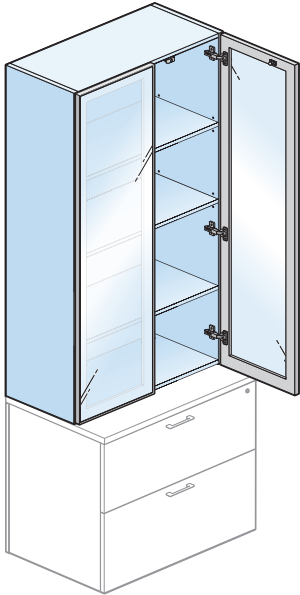
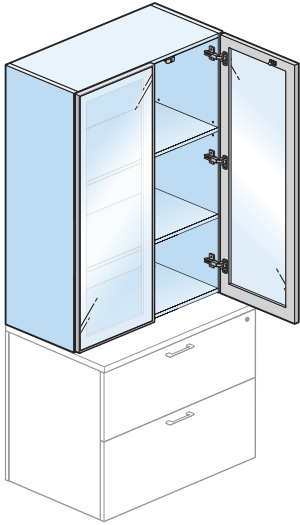

X4JL-ST
 X4JD-ST
 X5JL-ST
 X5JD-ST
 Class RA

Features

- Includes unfinished back, glass doors with concealed hinges and touch latch, attachment material, two adjustable shelves for 3H or three adjustable shelves for 4H unit.
- Adjustable .75"(19mm) thick shelf has $\pm 1.25"$ (32mm) adjustment range.
- Glass doors will be field installed.

Specification Tips

- Not for use on a freestanding pedestal desk or desk shell.
- 40"(1016mm)H nominal aligns with 5H storage units when stacked on top of 2H storage.
- 52"(1321mm)H aligns with 6H storage units when stacked on top of 2H storage.
- See Stack-on Application Rules in Specification Guide.
- Wood units are not designed for application where the back of unit is visible.

To Order, Specify:

- 1) Product number.
- 2) Finish code (laminate or wood).
- 3) Laminate edge trim color (if laminate specified).
- 4) Glass Code.
- 5) Trim color for glass frame

Stack-On Storage Cabinet

Glass Doors

Height	Depth	Width	Number	HPL A Glass				HPL B Glass			
				A	C	D	H	A	C	D	H
HPL — Letter Depth											
39.875"(1013mm)	14"(356mm)	30"(762mm)	X5JL-4030-NNST	\$ 2735.94	\$ 3697.61	\$ 3963.81	\$ 4496.18	\$ 2954.66	\$ 3916.33	\$ 4182.53	\$ 4714.90
	14"(356mm)	36"(914mm)	X5JL-4036-NNST	2818.88	3780.55	4046.75	4579.12	3040.21	4001.88	4268.08	4800.45
52.5"(1334mm)	14"(356mm)	30"(762mm)	X5JL-5230-NNST	\$ 3693.15	\$ 4654.82	\$ 4921.02	\$ 5453.39	\$ 3913.69	\$ 4875.36	\$ 5141.56	\$ 5673.93
	14"(356mm)	36"(914mm)	X5JL-5236-NNST	3809.29	4770.96	5037.16	5569.53	4032.44	4994.11	5260.31	5792.68
HPL — Legal Depth											
39.875"(1013mm)	16.5"(419mm)	30"(762mm)	X5JD-4030-NNST	\$ 2805.60	\$ 3767.27	\$ 4033.47	\$ 4565.84	\$ 3024.32	\$ 3985.99	\$ 4252.19	\$ 4784.56
	16.5"(419mm)	36"(914mm)	X5JD-4036-NNST	2888.54	3850.21	4116.41	4648.78	3109.87	4071.54	4337.74	4870.11
52.5"(1334mm)	16.5"(419mm)	30"(762mm)	X5JD-5230-NNST	\$ 3782.72	\$ 4744.39	\$ 5010.59	\$ 5542.96	\$ 4003.26	\$ 4964.93	\$ 5231.13	\$ 5763.50
	16.5"(419mm)	36"(914mm)	X5JD-5236-NNST	3898.86	4860.53	5126.73	5659.10	4122.01	5083.68	5349.88	5882.25
Wood A Glass											
Height	Depth	Width	Number	Wood A Glass				Wood B Glass			
				A	C	D	H	A	C	D	H
Wood — Letter Depth											
39.875"(1013mm)	14"(356mm)	30"(762mm)	X4JL-4030-NNST	\$ 4177.98	\$ 5139.65	\$ 5405.85	\$ 5938.22	\$ 4649.33	\$ 5611.00	\$ 5877.20	\$ 6409.57
	14"(356mm)	36"(914mm)	X4JL-4036-NNST	4260.92	5222.59	5488.79	6021.16	4742.29	5703.96	5970.16	6502.53
52.5"(1334mm)	14"(356mm)	30"(762mm)	X4JL-5230-NNST	\$ 5333.24	\$ 6294.91	\$ 6561.11	\$ 7093.48	\$ 5939.83	\$ 6901.50	\$ 7167.70	\$ 7700.07
	14"(356mm)	36"(914mm)	X4JL-5236-NNST	5449.38	6411.05	6677.25	7209.62	6065.99	7027.66	7293.86	7826.23
Wood — Legal Depth											
39.875"(1013mm)	16.5"(419mm)	30"(762mm)	X4JD-4030-NNST	\$ 4247.64	\$ 5209.31	\$ 5475.51	\$ 6007.88	\$ 4718.99	\$ 5680.66	\$ 5946.86	\$ 6479.23
	16.5"(419mm)	36"(914mm)	X4JD-4036-NNST	4330.58	5292.25	5558.45	6090.82	4811.95	5773.62	6039.82	6572.19
52.5"(1334mm)	16.5"(419mm)	30"(762mm)	X4JD-5230-NNST	\$ 5422.81	\$ 6384.48	\$ 6650.68	\$ 7183.05	\$ 6029.40	\$ 6991.07	\$ 7257.27	\$ 7789.64
	16.5"(419mm)	36"(914mm)	X4JD-5236-NNST	5538.95	6500.62	6766.82	7299.19	6155.56	7117.23	7383.43	7915.80

Reception Station

L-Shaped

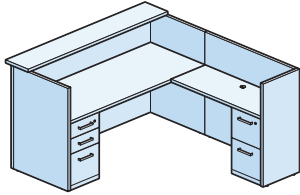

XPLR-RB
(Right-hand shown)
Class RA

Features

- Includes gallery enclosure with transaction shelf, two worksurfaces, two pedestals, one grommet and attachment hardware.
- Available in wood finish only.
- 1.18"(30mm) thick Wood worksurface with a choice of profiled edge (Square or Bevel) applied to user edge only.
- Double-cut veneers available with Square 3mm Radius edge only.
- Transaction shelf depth is 12"(305mm).
- Transaction shelf is 1.5"(38mm) thick with profiled edge both user and visitor sides.
- Pedestals are 15.5"(394mm)W.
- Box drawers with one black drawer divider per drawer and one black pencil tray per pedestal.
- File drawer with integrated file hanging system:
 - Letter size front-to-back filing
 - Legal size side-to-side filing
- Box and file drawers with full extension slides.
- Drawer pull options:
 - Bar pulls available in powdercoat finish.
 - Linear pulls available in both powdercoat finish and satin nickel. Satin nickel finish only.
 - Classic pulls are available in brushed nickel finish only. Finish code not required.
- One lock standard for each pedestal.
- Lock plug is available in black or chrome.
- For lock options, refer to Lock Program section of the Accessories Price List.
- Standard with 2"(51mm) grommet oriented to connection end of return; option of black or satin chrome finish.
- Glides provide 2"(51mm) adjustment range.
- Reception shell shipped unassembled, pedestals shipped assembled ready for field installation.

Specification Tips

- Handed design (left or right) based on orientation of return when seated at main worksurface.
- Accommodates separately specified center drawer.
- Specified edge profile is applied to both worksurface and countertop.
- Accommodates separately specified 12.5"(318mm)H KUAF Stretch and Pull Tackboards.

To Order, Specify:

1) Product number, including:

1 Edge Option:

Wood:

- 1 Square
- 5 Bevel (add **\$366.45** list)

2 Storage Option:

- 56 One Box/Box/File and One File/File Black Miterfold
- ST One Box/Box/File and One File/File Wood (add **\$308.46** list)

3 Orientation:

- L Left-hand
- R Right-hand

4 Pull Option:

- F Finger pull (wood only) (add **\$160.00** list)
- B Bar (add **\$85.00** list)
- 8 Linear
- 9 Classic (add **\$30.00** list)

2) Finish code for lower components (paint or wood).

3) Trim color for painted pull (if specified).

4) Trim color for locks and grommet (required).

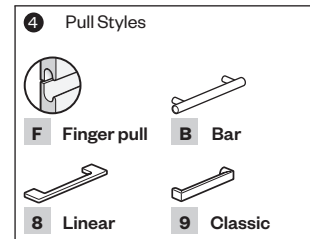

Height	Depth	Width	Number	Wood		
				A	B	
44.1875"(1122mm)	82.375"(2092mm)	74.25"(1886mm)	Enclosure	XZLR-8272-SS Y	\$11484.92	\$12856.22
	29.125"(740mm)	72"(1829mm)	Desk			
	18.125"(460mm)	48"(1219mm)	Return			

Reception Station

U-Shaped

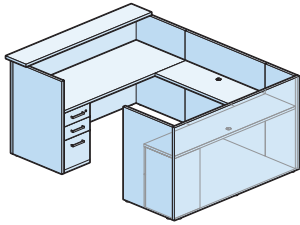

XZUR-RB
(Right-hand shown)
Class RA

Features

- Includes gallery enclosure with transaction shelf, three worksurfaces, two pedestals, two grommets and attachment hardware.
- Available in wood finish only.
- 1.18"(30mm) thick Wood worksurface with a choice of profiled edge (Square or Bevel) applied to user edge only.
- Double-cut veneers available with Square 3mm Radius edge only.
- Transaction shelf depth is 12"(305mm).
- Transaction shelf is 1.5"(38mm) thick with profiled edge both user and visitor sides.
- Pedestals are 15.5"(394mm)W.
- Box drawers with one black drawer divider per drawer and one black pencil tray per pedestal.
- File drawer with integrated file hanging system:
 - Letter size front-to-back filing
 - Legal size side-to-side filing
- Box and file drawers with full extension slides.
- Drawer pull options:
 - Bar pulls available in powdercoat finish.
 - Linear pulls available in both powdercoat finish and satin nickel. Satin nickel finish only.
 - Classic pulls are available in brushed nickel finish only. Finish code not required.
- One lock standard for each pedestal.
- Lock plug is available in black or chrome.
- For lock options, refer to Lock Program section of the Accessories Price List.
- Standard with 2"(51mm) grommet oriented to connection end of return; option of black or satin chrome finish.
- Glides provide 2"(51mm) adjustment range.
- Reception shell shipped unassembled, pedestals shipped assembled ready for field installation.

Specification Tips

- Handed design (left or right) based on orientation of return when seated at main worksurface.
- Accommodates separately specified center drawer.
- Specified edge profile is applied to both worksurface and countertop.
- Accommodates separately specified 12.5"(318mm)H KUAF Stretch and Pull Tackboards.

To Order, Specify:

1) Product number, including:

1 Edge Option:

Wood:

- 1 Square
- 5 Bevel (add \$489.27 list)

2 Storage Option:

56 One Box/Box/File and One File/File Black Miterfold

ST One Box/Box/File and One File/File Wood (add \$308.46 list)

3 Orientation:

- L Left-hand
- R Right-hand

4 Pull Option:

- F Finger pull (wood only) (add \$160.00 list)
- B Bar (add \$85.00 list)
- 8 Linear
- 9 Classic (add \$30.00 list)

2) Finish code for lower components (wood).

3) Laminate worksurface color (if option specified).

4) Laminate edge trim for worksurface (if option specified).

5) Trim color for painted pull (if specified).

6) Trim color for locks and grommet (required).

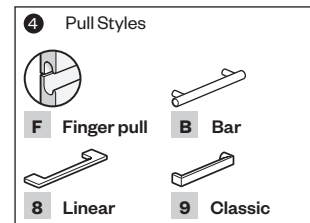

Height	Depth	Width	Number	Wood		
				A	B	
44.1875"(1122mm)	100.5"(2553mm)	74.25"(1886mm)	Enclosure	XZUR-A172- SS Y	\$13046.00	\$14417.30
	29.125"(740mm)	72"(1829mm)	Desk			
	18.125"(460mm)	48"(1219mm)	Return			
	18.125"(460mm)	72"(1829mm)	Credenza			

Modular Components

Storage Top

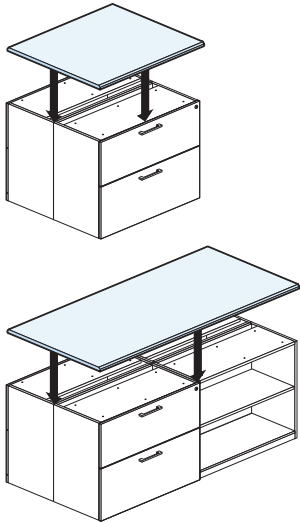

XLWT-SN
XZWT-SN
Class RA

Features

- 1.18”(30mm) thick high-pressure laminate (HPL) worksurface with 3mm edgeband applied to user and visitor edges only. Ends capped with 1mm thick edgeband.
- 1.18”(30mm) thick Wood worksurface with a choice of profiled edge (Square or Bevel) applied to user and visitor edges.
- Double-cut veneers available with Square 3mm Radius edge only.
- Profiled two edges.

Specification Tips

- For use with two back-to-back 18”(457mm)D (ganged) 2H or lower storage cabinets or lateral files.

To Order, Specify:

1) Product number, including:

1 Edge Option:

Wood:

1 Square

5 Bevel

2 Grain Direction (wood only):

F Front-to-back

S Side-to-side

2) Finish code (laminate or wood).

3) Laminate edge trim color (if laminate specified).

Depth	Width	Number 1 2	HPL		Wood A	Wood B
			A	B	Edge 1	Edge 1 5
HPL						
36.125”(918mm)	60”(1524mm)	XLWT-3660-JSNNN	\$ 744.63	\$ 793.22		
	66”(1676mm)	XLWT-3666-JSNNN	775.92	827.00		
	72”(1829mm)	XLWT-3672-JSNNN	807.21	860.78		
	90”(2286mm)	XLWT-3690-JSNNN	901.08	962.12		
	96”(2438mm)	XLWT-3696-JSNNN	932.37	995.90		
	102”(2591mm)	XLWT-36A2-JSNNN	963.66	1029.68		
	108”(2743mm)	XLWT-36A8-JSNNN	994.95	1063.46		
Wood						
36.125”(918mm)	60”(1524mm)	XZWT-3660- SN N			\$ 1738.03	\$ 1926.43 \$2049.25
	66”(1676mm)	XZWT-3666- SN N			1810.41	2006.65 2129.47
	72”(1829mm)	XZWT-3672- SN N			1882.79	2086.87 2209.69
	90”(2286mm)	XZWT-3690- SN N			2099.93	2327.53 2450.35
	96”(2438mm)	XZWT-3696- SN N			2172.31	2407.75 2530.57
	102”(2591mm)	XZWT-36A2- SN N			2244.69	2487.97 2610.79
	108”(2743mm)	XZWT-36A8- SN N			2317.07	2568.19 2691.01

Modular Components

Bookcase Top

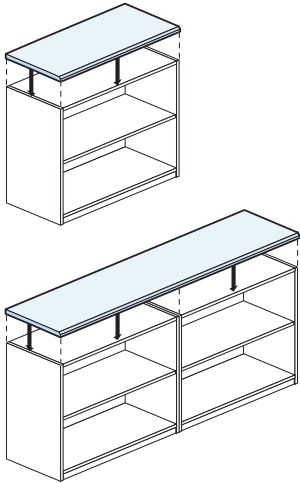

XLWF
XWWF
Class RA

Features

- 1.19"(30mm) thick high-pressure laminate (HPL) worksurface with 3mm edgeband applied to user and visitor edges only. Ends capped with 1mm thick edgeband.
- 1.19"(30mm) thick wood worksurface with a choice of profiled edge (Square or Bevel) applied to user and visitor edges.
- Double-cut veneers have a square 3mm radius edge, except for Walnut Grove, Clove on Walnut, and Auburn on Walnut.

Specification Tips

- For use with single letter or legal depth freestanding bookcases.
- Designed to align 2H bookcase to worksurface height.
- Wood Grain direction is applied side-to-side.

To Order, Specify:

1) Product number, including:

1 Edge Option:

Wood:

1 Square

5 Bevel

2) Finish code (laminate or wood).

3) Laminate edge trim color (if laminate specified).

Depth	Width	Number ①	HPL		Wood A	Wood B
			A	B	Edge 1	Edge 1
HPL						
14"(356mm)	30"(762mm)	XLWF-1430-JSNNN	\$ 172.00	\$ 201.30		
	36"(914mm)	XLWF-1436-JSNNN	203.29	237.03		
	60"(1524mm)	XLWF-1460-JSNNN	328.45	379.95		
	66"(1676mm)	XLWF-1466-JSNNN	359.74	415.68		
	72"(1829mm)	XLWF-1472-JSNNN	391.03	451.41		
16"(406mm)	30"(762mm)	XLWF-1630-JSNNN	\$209.56	\$ 241.92		
	36"(914mm)	XLWF-1636-JSNNN	228.33	264.11		
	60"(1524mm)	XLWF-1660-JSNNN	366.01	420.57		
	66"(1676mm)	XLWF-1666-JSNNN	397.30	456.30		
	72"(1829mm)	XLWF-1672-JSNNN	428.59	492.03		
Wood						
14"(356mm)	30"(762mm)	XZWF-1430-■SNSN			\$ 414.77	\$ 445.83 \$ 568.65
	36"(914mm)	XZWF-1436-■SNSN			487.15	526.05 648.87
	60"(1524mm)	XZWF-1460-■SNSN			776.67	846.93 969.75
	66"(1676mm)	XZWF-1466-■SNSN			849.05	927.15 1049.97
	72"(1829mm)	XZWF-1472-■SNSN			921.43	1007.37 1130.19
16"(406mm)	30"(762mm)	XZWF-1630-■SNSN			\$485.93	\$ 533.10 \$ 655.92
	36"(914mm)	XZWF-1636-■SNSN			534.59	584.23 707.05
	60"(1524mm)	XZWF-1660-■SNSN			847.83	934.20 1057.02
	66"(1676mm)	XZWF-1666-■SNSN			920.21	1014.42 1137.24
	72"(1829mm)	XZWF-1672-■SNSN			992.59	1094.64 1217.46

Modular Components

Credenza Top

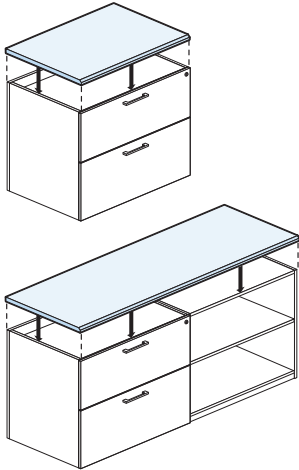

XLWF
XZWF
Class RA

Features

- 1.19”(30mm) thick high-pressure laminate (HPL) worktop with 3mm edgeband applied to user side, ends and visitor side capped with 1mm thick edgeband.
- 1.19”(30mm) thick wood worktop with a choice of 3mm or profile edge to user side, ends and back capped with 1mm veneer.
- Double-cut veneers have a square 3mm radius edge, except for Walnut Grove, Clove on Walnut, and Auburn on Walnut.
- Wood worktop available with choice of grain direction; side-to-side (standard) or front-to-back.

Specification Tips

- For use with other separately specified modular components such as pedestals, end panels, mid-support panels, L-supports and attached storage units to assemble modular credenza units.
- Designed to span two units.
- See Modular Components Application in Specification Guide.

To Order, Specify:

1) Product number, including:

1 Edge Option:

- J** Edgeband (Laminate only)
- 1** Square (Wood only)
- 5** Bevel (Wood only)

2 Grain Direction (wood only):

- F** Front-to-back
- S** Side-to-side

2) Finish code (laminate or wood).

3) Laminate edge trim color (if laminate specified).

Modular Components

Credenza Top

Depth	Nominal Width	Actual Width	Number	HPL	
				A	B
19"(483mm)	16"(406mm)	16.13"(410mm)	XLWF-1916-JSNNN	\$ 140.73	\$ 154.55
	19"(483mm)	19.13"(486mm)	XLWF-1919-JSNNN	140.73	154.55
	30"(762mm)	30.13"(765mm)	XLWF-1930-JSNNN	234.60	253.40
	36"(914mm)	36.13"(918mm)	XLWF-1936-JSNNN	265.89	287.18
	42"(1067mm)	42.13"(1070mm)	XLWF-1942-JSNNN	297.18	320.96
	48"(1219mm)	48.13"(1223mm)	XLWF-1948-JSNNN	328.47	354.74
	54"(1372mm)	54.13"(1375mm)	XLWF-1954-JSNNN	359.76	388.52
	60"(1524mm)	60.13"(1527mm)	XLWF-1960-JSNNN	391.05	422.30
	66"(1676mm)	66.13"(1680mm)	XLWF-1966-JSNNN	422.34	456.08
	72"(1829mm)	72.13"(1832mm)	XLWF-1972-JSNNN	453.63	489.86
	78"(1981mm)	78.13"(1985mm)	XLWF-1978-JSNNN	484.92	523.64
	84"(2134mm)	84.13"(2137mm)	XLWF-1984-JSNNN	516.21	557.42
	90"(2286mm)	90.13"(2289mm)	XLWF-1990-JSNNN	547.50	591.20
	96"(2438mm)	96.13"(2442mm)	XLWF-1996-JSNNN	578.79	624.98
	102"(2591mm)	102.13"(2594mm)	XLWF-19A2-JSNNN	610.08	658.76
108"(2743mm)	108.13"(2747mm)	XLWF-19A8-JSNNN	641.37	692.54	
114"(2896mm)	114.13"(2899mm)	XLWF-19B4-JSNNN	672.66	726.32	
120"(3048mm)	120.13"(3051mm)	XLWF-19C0-JSNNN	703.95	760.10	
24"(610mm)	16"(406mm)	16.13"(410mm)	XLWF-2416-JSNNN	\$203.33	\$ 222.25
	19"(483mm)	19.13"(486mm)	XLWF-2419-JSNNN	203.33	222.25
	30"(762mm)	30.13"(765mm)	XLWF-2430-JSNNN	297.20	321.10
	36"(914mm)	36.13"(918mm)	XLWF-2436-JSNNN	328.49	354.88
	42"(1067mm)	42.13"(1070mm)	XLWF-2442-JSNNN	359.78	388.66
	48"(1219mm)	48.13"(1223mm)	XLWF-2448-JSNNN	391.07	422.44
	54"(1372mm)	54.13"(1375mm)	XLWF-2454-JSNNN	422.36	456.22
	60"(1524mm)	60.13"(1527mm)	XLWF-2460-JSNNN	453.65	490.00
	66"(1676mm)	66.13"(1680mm)	XLWF-2466-JSNNN	484.94	523.78
	72"(1829mm)	72.13"(1832mm)	XLWF-2472-JSNNN	516.23	557.56
	78"(1981mm)	78.13"(1985mm)	XLWF-2478-JSNNN	547.52	591.34
	84"(2134mm)	84.13"(2137mm)	XLWF-2484-JSNNN	578.81	625.12
	90"(2286mm)	90.13"(2289mm)	XLWF-2490-JSNNN	610.10	658.90
	96"(2438mm)	96.13"(2442mm)	XLWF-2496-JSNNN	641.39	692.68
	102"(2591mm)	102.13"(2594mm)	XLWF-24A2-JSNNN	672.68	726.46
108"(2743mm)	108.13"(2747mm)	XLWF-24A8-JSNNN	703.97	760.24	
114"(2896mm)	114.13"(2899mm)	XLWF-24B4-JSNNN	735.26	794.02	
120"(3048mm)	120.13"(3051mm)	XLWF-24C0-JSNNN	766.55	827.80	
30"(762mm)	16"(406mm)	16.13"(410mm)	XLWF-3016-JSNNN	\$ 278.45	\$303.49
	19"(483mm)	19.13"(486mm)	XLWF-3019-JSNNN	278.45	303.49
	30"(762mm)	30.13"(765mm)	XLWF-3030-JSNNN	372.32	402.34
	36"(914mm)	36.13"(918mm)	XLWF-3036-JSNNN	403.61	436.12
	42"(1067mm)	42.13"(1070mm)	XLWF-3042-JSNNN	434.90	469.90
	48"(1219mm)	48.13"(1223mm)	XLWF-3048-JSNNN	466.19	503.68
	54"(1372mm)	54.13"(1375mm)	XLWF-3054-JSNNN	497.48	537.46
	60"(1524mm)	60.13"(1527mm)	XLWF-3060-JSNNN	528.77	571.24
	66"(1676mm)	66.13"(1680mm)	XLWF-3066-JSNNN	560.06	605.02
	72"(1829mm)	72.13"(1832mm)	XLWF-3072-JSNNN	591.35	638.80
	78"(1981mm)	78.13"(1985mm)	XLWF-3078-JSNNN	622.64	672.58
	84"(2134mm)	84.13"(2137mm)	XLWF-3084-JSNNN	653.93	706.36
	90"(2286mm)	90.13"(2289mm)	XLWF-3090-JSNNN	685.22	740.14
	96"(2438mm)	96.13"(2442mm)	XLWF-3096-JSNNN	716.51	773.92
	102"(2591mm)	102.13"(2594mm)	XLWF-30A2-JSNNN	747.80	807.70
108"(2743mm)	108.13"(2747mm)	XLWF-30A8-JSNNN	779.09	841.48	
114"(2896mm)	114.13"(2899mm)	XLWF-30B4-JSNNN	810.38	875.26	
120"(3048mm)	120.13"(3051mm)	XLWF-30C0-JSNNN	841.67	909.04	

Modular Components

Credenza Top

Depth	Nominal Width	Actual Width	Number ① ②	Wood A	Wood B	
				Edge 1	Edge 1	5
19"(483mm)	16"(406mm)	16.13"(410mm)	XZWF-1916- SN N	\$ 357.32	\$ 399.55	\$ 522.37
	19"(483mm)	19.13"(486mm)	XZWF-1919- SN N	357.32	399.55	522.37
	30"(762mm)	30.13"(765mm)	XZWF-1930- SN N	533.37	591.28	714.10
	36"(914mm)	36.13"(918mm)	XZWF-1936- SN N	605.75	671.50	794.32
	42"(1067mm)	42.13"(1070mm)	XZWF-1942- SN N	678.13	751.72	874.54
	48"(1219mm)	48.13"(1223mm)	XZWF-1948- SN N	750.51	831.94	954.76
	54"(1372mm)	54.13"(1375mm)	XZWF-1954- SN N	822.89	912.16	1034.98
	60"(1524mm)	60.13"(1527mm)	XZWF-1960- SN N	895.27	992.38	1115.20
	66"(1676mm)	66.13"(1680mm)	XZWF-1966- SN N	967.65	1072.60	1195.42
	72"(1829mm)	72.13"(1832mm)	XZWF-1972- SN N	1040.03	1152.82	1275.64
	78"(1981mm)	78.13"(1985mm)	XZWF-1978- SN N	1112.41	1233.04	1355.86
	84"(2134mm)	84.13"(2137mm)	XZWF-1984- SN N	1184.79	1313.26	1436.08
	90"(2286mm)	90.13"(2289mm)	XZWF-1990- SN N	1257.17	1393.48	1516.30
	96"(2438mm)	96.13"(2442mm)	XZWF-1996- SN N	1329.55	1473.70	1596.52
	102"(2591mm)	102.13"(2594mm)	XZWF-19A2- SN N	1401.93	1553.92	1676.74
108"(2743mm)	108.13"(2747mm)	XZWF-19A8- SN N	1474.31	1634.14	1756.96	
114"(2896mm)	114.13"(2899mm)	XZWF-19B4- SN N	1546.69	1714.36	1837.18	
120"(3048mm)	120.13"(3051mm)	XZWF-19C0- SN N	1619.07	1794.58	1917.40	
24"(610mm)	16"(406mm)	16.13"(410mm)	XZWF-2416- SN N	\$ 475.92	\$ 545.00	\$ 667.82
	19"(483mm)	19.13"(486mm)	XZWF-2419- SN N	475.92	545.00	667.82
	30"(762mm)	30.13"(765mm)	XZWF-2430- SN N	651.97	736.73	859.55
	36"(914mm)	36.13"(918mm)	XZWF-2436- SN N	724.35	816.95	939.77
	42"(1067mm)	42.13"(1070mm)	XZWF-2442- SN N	796.73	897.17	1019.99
	48"(1219mm)	48.13"(1223mm)	XZWF-2448- SN N	869.11	977.39	1100.21
	54"(1372mm)	54.13"(1375mm)	XZWF-2454- SN N	941.49	1057.61	1180.43
	60"(1524mm)	60.13"(1527mm)	XZWF-2460- SN N	1013.87	1137.83	1260.65
	66"(1676mm)	66.13"(1680mm)	XZWF-2466- SN N	1086.25	1218.05	1340.87
	72"(1829mm)	72.13"(1832mm)	XZWF-2472- SN N	1158.63	1298.27	1421.09
	78"(1981mm)	78.13"(1985mm)	XZWF-2478- SN N	1231.01	1378.49	1501.31
	84"(2134mm)	84.13"(2137mm)	XZWF-2484- SN N	1303.39	1458.71	1581.53
	90"(2286mm)	90.13"(2289mm)	XZWF-2490- SN N	1375.77	1538.93	1661.75
	96"(2438mm)	96.13"(2442mm)	XZWF-2496- SN N	1448.15	1619.15	1741.97
	102"(2591mm)	102.13"(2594mm)	XZWF-24A2- SN N	1520.53	1699.37	1822.19
108"(2743mm)	108.13"(2747mm)	XZWF-24A8- SN N	1592.91	1779.59	1902.41	
114"(2896mm)	114.13"(2899mm)	XZWF-24B4- SN N	1665.29	1859.81	1982.63	
120"(3048mm)	120.13"(3051mm)	XZWF-24C0- SN N	1737.67	1940.03	2062.85	
30"(762mm)	16"(406mm)	16.13"(410mm)	XZWF-3016- SN N	\$ 618.24	\$ 719.54	\$ 842.36
	19"(483mm)	19.13"(486mm)	XZWF-3019- SN N	618.24	719.54	842.36
	30"(762mm)	30.13"(765mm)	XZWF-3030- SN N	794.29	911.27	1034.09
	36"(914mm)	36.13"(918mm)	XZWF-3036- SN N	866.67	991.49	1114.31
	42"(1067mm)	42.13"(1070mm)	XZWF-3042- SN N	939.05	1071.71	1194.53
	48"(1219mm)	48.13"(1223mm)	XZWF-3048- SN N	1011.43	1151.93	1274.75
	54"(1372mm)	54.13"(1375mm)	XZWF-3054- SN N	1083.81	1232.15	1354.97
	60"(1524mm)	60.13"(1527mm)	XZWF-3060- SN N	1156.19	1312.37	1435.19
	66"(1676mm)	66.13"(1680mm)	XZWF-3066- SN N	1228.57	1392.59	1515.41
	72"(1829mm)	72.13"(1832mm)	XZWF-3072- SN N	1300.95	1472.81	1595.63
	78"(1981mm)	78.13"(1985mm)	XZWF-3078- SN N	1373.33	1553.03	1675.85
	84"(2134mm)	84.13"(2137mm)	XZWF-3084- SN N	1445.71	1633.25	1756.07
	90"(2286mm)	90.13"(2289mm)	XZWF-3090- SN N	1518.09	1713.47	1836.29
	96"(2438mm)	96.13"(2442mm)	XZWF-3096- SN N	1590.47	1793.69	1916.51
	102"(2591mm)	102.13"(2594mm)	XZWF-30A2- SN N	1662.85	1873.91	1996.73
108"(2743mm)	108.13"(2747mm)	XZWF-30A8- SN N	1735.23	1954.13	2076.95	
114"(2896mm)	114.13"(2899mm)	XZWF-30B4- SN N	1807.61	2034.35	2157.17	
120"(3048mm)	120.13"(3051mm)	XZWF-30C0- SN N	1879.99	2114.57	2237.39	

Modular Components

Full-Overlay Modesty Panel

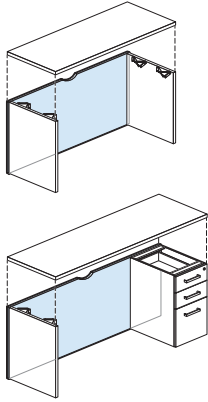
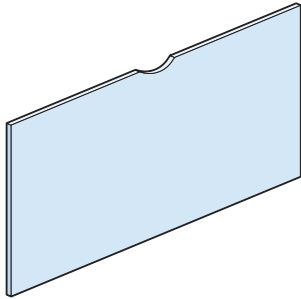

ULXF-SS
UXXF-SS
Class RA

Features

- Includes .75"(19mm) thick modesty panel.
- Field supplied hardware.
- Optional unfinished clearcoat wireway scallop available located at center of the top of the panel.

Specification Tips

- For use with separately specified modular components (worksurface and support panels) and attached storage units to assemble credenza units.
- Attachment hardware ships with storage units or end supports.
- See Modular Components Application in Specification Guide.

To Order, Specify:

1) Product number, including:

1 Scallop Option:

N No Scallop

S Scallop

2) Finish code (laminate or wood).

3) Laminate edge trim color (if laminate specified).

Height	Width	Number ①	HPL		Wood	
			A	B	A	B
HPL						
27.5"(699mm)	30"(762mm)	ULXF-2730-S	\$ 339.84	\$ 367.05		
	36"(914mm)	ULXF-2736-S	401.40	433.83		
	42"(1067mm)	ULXF-2742-S	462.96	500.61		
	48"(1219mm)	ULXF-2748-S	524.52	567.39		
	54"(1372mm)	ULXF-2754-S	586.08	634.17		
	60"(1524mm)	ULXF-2760-S	647.64	700.95		
	66"(1676mm)	ULXF-2766-S	709.20	767.73		
	72"(1829mm)	ULXF-2772-S	770.76	834.51		
	78"(1981mm)	ULXF-2778-S	832.32	901.29		
	84"(2134mm)	ULXF-2784-S	893.88	968.07		
	90"(2286mm)	ULXF-2790-S	955.44	1034.85		
	96"(2438mm)	ULXF-2796-S	1017.00	1101.63		
	102"(2591mm)	ULXF-27A2-S	1078.56	1168.41		
	108"(2743mm)	ULXF-27A8-S	1140.12	1235.19		
	114"(2896mm)	ULXF-27B4-S	1201.68	1301.97		
	120"(3048mm)	ULXF-27C0-S	1263.24	1368.75		
Wood						
27.5"(699mm)	30"(762mm)	UXXF-2730-S			\$ 640.50	\$ 711.99
	36"(914mm)	UXXF-2736-S			724.74	805.05
	42"(1067mm)	UXXF-2742-S			808.98	898.11
	48"(1219mm)	UXXF-2748-S			893.22	991.17
	54"(1372mm)	UXXF-2754-S			977.46	1084.23
	60"(1524mm)	UXXF-2760-S			1061.70	1177.29
	66"(1676mm)	UXXF-2766-S			1145.94	1270.35
	72"(1829mm)	UXXF-2772-S			1230.18	1363.41
	78"(1981mm)	UXXF-2778-S			1314.42	1456.47
	84"(2134mm)	UXXF-2784-S			1398.66	1549.53
	90"(2286mm)	UXXF-2790-S			1482.90	1642.59
	96"(2438mm)	UXXF-2796-S			1567.14	1735.65
	102"(2591mm)	UXXF-27A2-S			1651.38	1828.71
	108"(2743mm)	UXXF-27A8-S			1735.62	1921.77
	114"(2896mm)	UXXF-27B4-S			1819.86	2014.83
	120"(3048mm)	UXXF-27C0-S			1904.10	2107.89

Modular Components

Hinged Modesty Panel

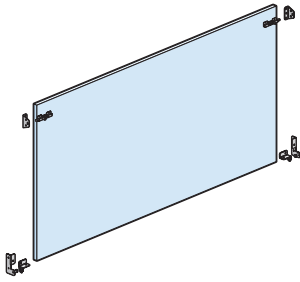

Features

- Includes .75"(19mm) thick modesty panel and attachment hardware.
- Allows for access to power or voice/data when used with other modular components to assemble modular credenza.

Specification Tips

- No wireway scallop included.
- For use with separately specified modular components (credenza top, L-support panels, intermediate T-supports, storage units, etc.) to assemble modular credenza.

To Order, Specify:

1) Product number, including:

1 Finish Option (wood only):

- 1** Finished front
- 2** Finished front and back

2) Finish code (laminate or wood).

3) Laminate edge trim color (if laminate specified).

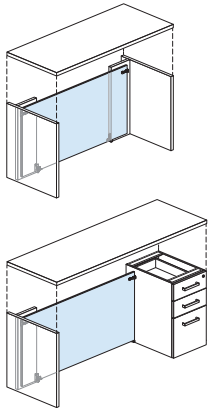

ULXH-SN2
UXXH-SN2
Class RA

Height	Width	Number	HPL		Wood A		Wood B	
			A	B	1	2	1	2
HPL								
25.5"(648mm)	24"(610mm)	ULXH-2624-SN2	\$483.77	\$522.49				
	30"(762mm)	ULXH-2630-SN2	539.91	582.67				
	36"(914mm)	ULXH-2636-SN2	596.05	642.85				
	42"(1067mm)	ULXH-2642-SN2	652.19	703.03				
	48"(1219mm)	ULXH-2648-SN2	708.33	763.21				
	54"(1372mm)	ULXH-2654-SN2	764.47	823.39				
	60"(1524mm)	ULXH-2660-SN2	820.61	883.57				
	66"(1676mm)	ULXH-2666-SN2	876.75	943.75				
Wood								
25.5"(648mm)	24"(610mm)	UXXH-2624-SN			\$ 738.97	\$ 812.65	\$ 824.03	\$ 905.09
	30"(762mm)	UXXH-2630-SN			834.15	910.18	928.72	1009.78
	36"(914mm)	UXXH-2636-SN			929.33	1007.71	1033.41	1114.47
	42"(1067mm)	UXXH-2642-SN			1024.51	1105.24	1138.10	1219.16
	48"(1219mm)	UXXH-2648-SN			1119.69	1202.77	1242.79	1323.85
	54"(1372mm)	UXXH-2654-SN			1214.87	1300.30	1347.48	1428.54
	60"(1524mm)	UXXH-2660-SN			1310.05	1397.83	1452.17	1533.23
	66"(1676mm)	UXXH-2666-SN			1405.23	1495.36	1556.86	1637.92

Modular Components

Adaptable Hinged Modesty Panel

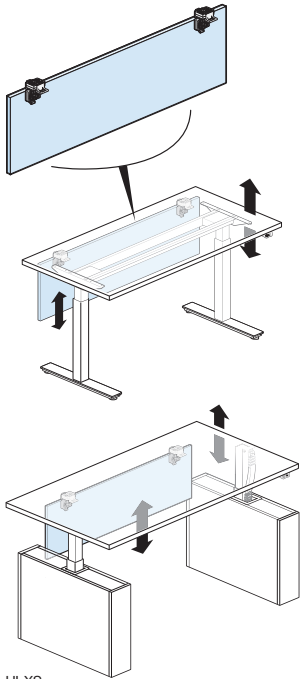

ULXS
 UXXS
 UFXS
 Class RA

Features

- Includes a high-pressure laminate (HPL), wood or fabric hinged modesty panel and attachment hardware.
- Modesty Panels are 11.59"(294mm)H (actual) and 0.56"(14mm) thick.
- Modesty Panels are mounted 1.4"(36mm) below the table top to allow for wire pass-through.
- Fabric surface is non-tackable.
- Modesty panel is removable; slides into table attachment brackets. No tools required.
- Screen and hardware are field installed.

Specification Tips

- For use on Fixed Height or Height Adjustable Table Desk, Height Adjustable Credenza Desk and Fixed Height or Height Adjustable Convergent Worktop with or without shroud(s), if applicable.
- A Height Adjustable Table Desk or Credenza Desk with a pair of shrouds may be used with either an Adaptable Modesty or a Modesty Panel for Shroud or both modesty panels may be used together in a layered application:
 - The Adaptable Modesty panel is installed outboard of the Modesty Panel for Shroud.
 - The Modesty Panel for Shroud is stationary and provides modesty between the pair of shrouds.
 - The Adaptable Modesty Panel is attached to the underside of the desk and provides height adjustable modesty when the desk is raised or lowered.
- A Height Adjustable Convergent Worktop with or without a single shroud may be used with only an Adaptable Modesty Panel:
 - The Adaptable Modesty panel is installed between the shroud or T-Leg and front of the 1.5H Attached Lower Storage Unit.
 - The Adaptable Modesty Panel is attached to the underside of the desk and provides height adjustable modesty when the desk is raised or lowered.
 - When the Table Desk is raised to full height a 9"(229mm) gap between panels.

To Order, Specify:

- 1) Product number.
- 2) Laminate, wood or fabric color.
- 3) Edge trim color (laminate only).

Modular Components

Adaptable Hinged Modesty Panel

Adaptable Modesty Panel Application Widths

TABLE DESKS			
TABLE DESK WIDTH	HEIGHT ADJUSTABLE		FIXED HEIGHT
	SHROUD PAIR	NO SHROUD	HOOP BASE
	MODESTY PANEL WIDTH		
58"(1473mm)	39"	54"	
64"(1626mm)	45"	60"	
70"(1778mm)	51"	66"	
76"(1930mm)	57"	72"	
82"(2083mm)	63"	78"	
60"(1524mm)			54"
66"(1676mm)			60"
72"(1829mm)			66"
78"(1981mm)			72"
84"(2134mm)			78"

FLOATING CONVERGENT WORKTOP / STORAGE SUPPORTED APPLICATION												
CONVERGENT WORKTOP WIDTH	Column Support						Hoop Leg Support					
	19" DEEP STORAGE			24" DEEP STORAGE			19" DEEP STORAGE			24" DEEP STORAGE		
	Rectangle Top	Wedge Square Top	Wedge Radius Top	Rectangle Top	Wedge Square Top	Wedge Radius Top	Rectangle Top	Wedge Square Top	Wedge Radius Top	Rectangle Top	Wedge Square Top	Wedge Radius Top
60"(1524mm)	36"	36"	36"	30"	30"	30"	36"	36"	36"	30"	30"	30"
66"(1676mm)	42"	42"	42"	36"	36"	36"	42"	42"	42"	36"	36"	36"
72"(1829mm)	48"	48"	48"	42"	42"	42"	48"	48"	48"	42"	42"	42"
78"(1981mm)	54"	54"	54"	48"	48"	48"	54"	54"	54"	48"	48"	48"
84"(2134mm)	60"	60"	60"	54"	54"	54"	60"	60"	60"	54"	54"	54"

HEIGHT ADJUSTABLE CONVERGENT WORKTOP / CONCEALED LEG IN STORAGE APPLICATION												
TABLE DESK WIDTH	19" DEEP STORAGE						24" DEEP STORAGE					
	SHROUD			NO SHROUD			SHROUD			NO SHROUD		
	Rectangle Top	Wedge Square Top	Wedge Radius Top	Rectangle Top	Wedge Square Top	Wedge Radius Top	Rectangle Top	Wedge Square Top	Wedge Radius Top	Rectangle Top	Wedge Square Top	Wedge Radius Top
58"(1473mm)	30"	30"	27"	36"	36"	33"	24"	24"	21"	30"	30"	27"
64"(1626mm)	36"	36"	33"	42"	42"	39"	30"	30"	27"	36"	36"	33"
70"(1778mm)	42"	42"	39"	48"	48"	45"	36"	36"	33"	42"	42"	39"
76"(1930mm)	48"	48"	45"	54"	54"	51"	42"	42"	39"	48"	48"	45"
82"(2083mm)	54"	54"	51"	60"	60"	57"	48"	48"	45"	54"	54"	51"

Modular Components

Adaptable Hinged Modesty Panel

Height	Width	HPL Number	HPL		Wood Number	Wood	
			A	B		A	B
13"(330mm)	21"(533mm)	ULXS-1321	\$ 185.98	\$ 190.18	UXXS-1321	\$ 510.49	\$ 577.56
	24"(610mm)	ULXS-1324	203.38	208.98	UXXS-1324	544.94	618.15
	27"(686mm)	ULXS-1327	220.78	227.78	UXXS-1327	579.39	658.74
	30"(762mm)	ULXS-1330	238.18	246.58	UXXS-1330	613.84	699.33
	36"(914mm)	ULXS-1336	272.98	284.18	UXXS-1336	682.74	780.51
	39"(991mm)	ULXS-1339	290.38	302.98	UXXS-1339	717.19	821.10
	42"(1067mm)	ULXS-1342	307.78	321.78	UXXS-1342	751.64	861.69
	45"(1143mm)	ULXS-1345	325.18	340.58	UXXS-1345	786.09	902.28
	48"(1219mm)	ULXS-1348	342.58	359.38	UXXS-1348	820.54	942.87
	51"(1295mm)	ULXS-1351	359.98	378.18	UXXS-1351	854.99	983.46
	54"(1372mm)	ULXS-1354	377.38	396.98	UXXS-1354	889.44	1024.05
	57"(1448mm)	ULXS-1357	394.78	415.78	UXXS-1357	923.89	1064.64
	60"(1524mm)	ULXS-1360	412.18	434.58	UXXS-1360	958.34	1105.23
	63"(1600mm)	ULXS-1363	429.58	453.38	UXXS-1363	992.79	1145.82
	66"(1676mm)	ULXS-1366	446.98	472.18	UXXS-1366	1027.24	1186.41
	69"(1753mm)	ULXS-1369	464.38	490.98	UXXS-1369	1061.69	1227.00
	72"(1829mm)	ULXS-1372	481.78	509.78	UXXS-1372	1096.14	1267.59
	75"(1905mm)	ULXS-1375	499.18	528.58	UXXS-1375	1130.59	1308.18
	78"(1981mm)	ULXS-1378	516.58	547.38	UXXS-1378	1165.04	1348.77

Height	Width	Number	Fabric						
			A	B	C	D	E	F	G
13"(330mm)	21"(533mm)	UFXS-1321	\$290.70	\$ 301.59	\$ 313.57	\$326.61	\$339.68	\$ 357.10	\$ 367.97
	24"(610mm)	UFXS-1324	319.16	330.05	342.03	355.07	368.14	385.56	396.43
	27"(686mm)	UFXS-1327	347.62	358.51	370.49	383.53	396.60	414.02	424.89
	30"(762mm)	UFXS-1330	376.08	386.97	398.95	411.99	425.06	442.48	453.35
	33"(838mm)	UFXS-1333	404.54	415.43	427.41	440.45	453.52	470.94	481.81
	36"(914mm)	UFXS-1336	433.00	443.89	455.87	468.91	481.98	499.40	510.27
	39"(991mm)	UFXS-1339	461.46	472.35	484.33	497.37	510.44	527.86	538.73
	42"(1067mm)	UFXS-1342	489.92	500.81	512.79	525.83	538.90	556.32	567.19
	45"(1143mm)	UFXS-1345	518.38	529.27	541.25	554.29	567.36	584.78	595.65
	48"(1219mm)	UFXS-1348	546.84	557.73	569.71	582.75	595.82	613.24	624.11
	51"(1295mm)	UFXS-1351	575.30	586.19	598.17	611.21	624.28	641.70	652.57
	54"(1372mm)	UFXS-1354	603.76	614.65	626.63	639.67	652.74	670.16	681.03
	57"(1448mm)	UFXS-1357	632.22	643.11	655.09	668.13	681.20	698.62	709.49
	60"(1524mm)	UFXS-1360	660.68	671.57	683.55	696.59	709.66	727.08	737.95
	63"(1600mm)	UFXS-1363	689.14	700.03	712.01	725.05	738.12	755.54	766.41
	66"(1676mm)	UFXS-1366	717.60	728.49	740.47	753.51	766.58	784.00	794.87
	69"(1753mm)	UFXS-1369	746.06	756.95	768.93	781.97	795.04	812.46	823.33
	72"(1829mm)	UFXS-1372	774.52	785.41	797.39	810.43	823.50	840.92	851.79
	75"(1905mm)	UFXS-1375	802.98	813.87	825.85	838.89	851.96	869.38	880.25
	78"(1981mm)	UFXS-1378	831.44	842.33	854.31	867.35	880.42	897.84	908.71

Modular Components

2H End Panel

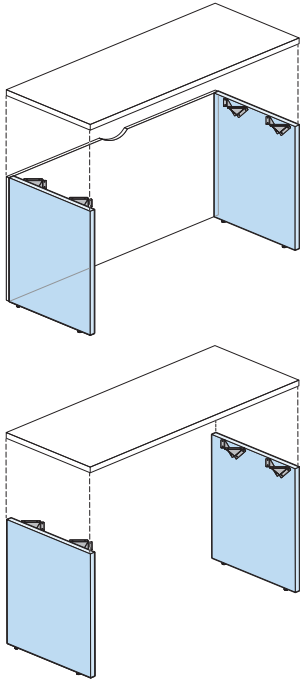

ULSE
UXSE
Class RA

Features

- Includes 1.125"(29mm) thick support panel, glides and attachment hardware.
- Option of 19"(483mm), 24"(610mm) and 30"(762mm) full depth for use without modesty panel.
- Option of 18.25"(464mm), 23.25"(591mm) or 29.25"(743mm) depth for use with full overlay modesty panel.
- Provides full support for one end of equal depth worksurface.
- Glides provide 2"(51mm) adjustment range.

Specification Tips

- For use with other separately specified modular components, (modular credenza, worksurfaces, mid-support panels and modesty panels) to assemble modular shells and credenzas.
- Wing leg inset from the back of the slab legs 4.1875"(106mm).
- Not recommended for use next to an attached storage unit on the inner face due to bracket interference.
- See Modular Components Application in Specification Guide.

To Order, Specify:

1) Product number, including:

1 Orientation:

L Left-hand

R Right-hand

2) Finish code (laminate or wood).

3) Laminate edge trim color (if laminate specified).

Height	Depth	Number ①	HPL		Wood	
			A	B	A	B
HPL — Full Overlay Modesty Panel Application						
28"(711mm)	18.25"(464mm)	ULSE-2818-S M	\$348.63	\$376.51		
	23.25"(591mm)	ULSE-2823-S M	366.23	395.56		
	29.25"(743mm)	ULSE-2829-S M	387.35	418.42		
HPL — No Modesty Panel Application						
28"(711mm)	19"(483mm)	ULSE-2819-S N	\$348.63	\$376.51		
	24"(610mm)	ULSE-2824-S N	366.23	395.56		
	30"(762mm)	ULSE-2830-S N	387.35	418.42		
Wood — Full Overlay Modesty Panel Application						
28"(711mm)	18.25"(464mm)	UXSE-2818-S M			\$555.55	\$566.50
	23.25"(591mm)	UXSE-2823-S M			597.85	610.30
	29.25"(743mm)	UXSE-2829-S M			648.61	662.86
Wood — No Modesty Panel Application						
28"(711mm)	19"(483mm)	UXSE-2819-S N			\$555.55	\$566.50
	24"(610mm)	UXSE-2824-S N			597.85	610.30
	30"(762mm)	UXSE-2830-S N			648.61	662.86

Modular Components

L-Support Panel

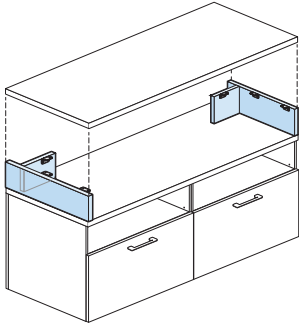

0.5H

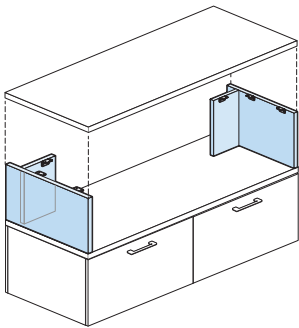

1H

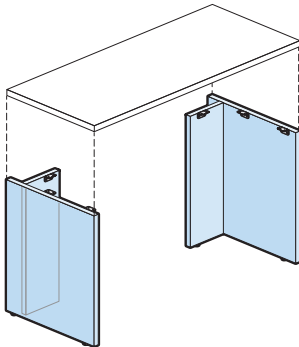

2H
XLGS
ULSL
XZGS
UXSL
Class RA

Features

- Includes 1.125"(29mm) thick full depth end panel, 10"(254mm)W support panel, glides (only 2H) and attachment hardware.
- Includes 1.125"(29mm) thick full depth end panel, 14"(356mm)W support panel and attachment hardware.
- Option of 19"(483mm), 24"(610mm) and 30"(762mm)D full end panel to provide full support at one end of worksurface.
- Provides full support for one end of equal depth top.
- 2H L-support includes glides with 2"(51mm) adjustment range.
- 30"(762mm) depth available in 2H only.
- Designed to be used with hinged modesty panel.

Specification Tips

- For use with other separately specified modular components (worksurfaces and mid-support panels) and attached storage units to assemble credenza units.
- Not designed for use with full overlay modesty panel.
- Wing leg inset from the back of the slab legs 4.1875"(106mm).
- Not recommended for use next to an attached storage unit on the inner face due to bracket interference.
- 6H L-Support panel for use with 1.5H modular storage unit(s).
- 12H L-Support panel for use with 1H modular storage unit(s).
- See Applications in Specification Guide.

To Order, Specify:

1) Product number, including:

1 Orientation:

L Left-hand

R Right-hand

2) Finish code (laminate or wood).

3) Laminate edge trim color (if laminate specified).

Modular Components

L-Support Panel

Height	Actual Overall Depth	Actual Width	Number ①	HPL A	B	Wood A	B
HPL — 0.5H							
6"(152mm)	18.88"(480mm)	10.06"(256mm)	XLGS-0619-S	\$340.15	\$439.10		
	23.88"(607mm)		XLGS-0624-S	359.70	500.55		
HPL — 1H							
11.56"(294mm)	18.88"(480mm)	10.06"(256mm)	XLGS-1219-S	\$ 377.71	\$492.83		
	23.88"(607mm)		XLGS-1224-S	397.26	554.28		
HPL — 2H							
28"(711mm)	18.88"(480mm)	10.06"(256mm)	ULSL-2819-S	\$ 477.87	\$636.11		
	23.88"(607mm)		ULSL-2824-S	497.42	697.56		
	29.88"(759mm)		ULSL-2830-S	520.88	771.30		
Wood — 0.5H							
6"(152mm)	18.88"(480mm)	10.06"(256mm)	XZGS-0619-S			\$533.31	\$595.15
	23.88"(607mm)		XZGS-0624-S			566.81	632.35
Wood — 1H							
11.56"(294mm)	18.88"(480mm)	10.06"(256mm)	XZGS-1219-S			\$598.92	\$662.38
	23.88"(607mm)		XZGS-1224-S			632.42	699.58
Wood — 2H							
28"(711mm)	18.88"(480mm)	10.06"(256mm)	UXSL-2819-S			\$ 773.88	\$ 841.66
	23.88"(607mm)		UXSL-2824-S			807.38	878.86
	29.88"(759mm)		UXSL-2830-S			847.58	923.50

Modular Components

2H Partial Depth L-Support Panel

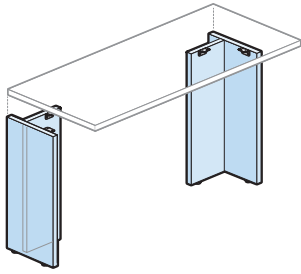

Bridge Application

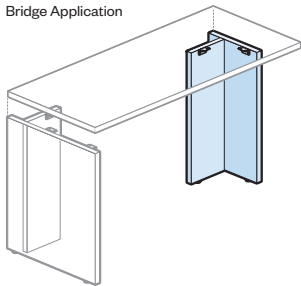

Fixed Return Applications

ULSL-SL
ULSL-SR
UXSL-SL
UXSL-SR
Class RA

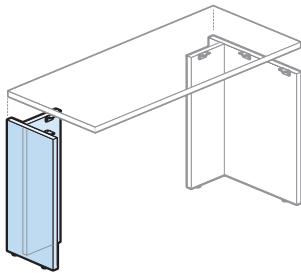

Features

- Includes 1.125" (29mm) thick 10.125" (257mm) D end panel, 9" (229mm) W support panel, glides and attachment hardware.
- Designed to be used with a hinged modesty panel.
- Glides provide 2" (51mm) adjustment range.

Specification Tips

- For use with other separately specified modular components (worksurface, pedestals, mid-support panels and modesty panels) to assemble modular bridge or return.
- Not designed for use with full overlay modesty panel.
- Wing leg inset from the back of the slab legs 4.1875" (106mm).
- Not recommended for use next to an attached storage unit on the inner face due to bracket interference.
- See Modular Components Application in Specification Guide.
- A single partial depth L-support panel may not be used for knee swing application.
- Two partial depth L-support panels may not be used to configure a freestanding desk or credenza shell. Use the full depth L-support panel for this application.

To Order, Specify:

1) Product number, including:

1 Orientation:

L Left-hand

R Right-hand

2) Finish code (laminate or wood).

3) Laminate edge trim color (if laminate specified).

Height	Actual Overall Depth	Actual Width	Number ①	HPL A	B	Wood A	B
HPL							
28" (711mm)	10.06" (256mm)	10" (254mm)	ULSL-2810-S	\$442.68	\$525.50		
Wood							
28" (711mm)	10.06" (256mm)	10" (254mm)	UXSL-2810-S			\$713.58	\$774.70

Modular Components

T-Support Panel

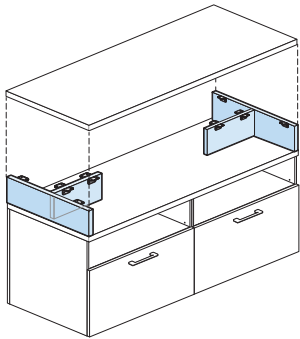

0.5H

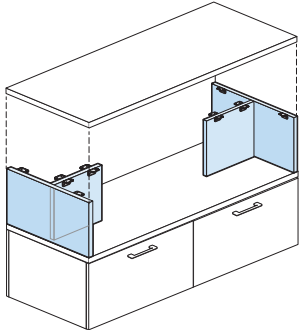

1H
XLFS-SN
XZFS-SN
Class RA

Features

- Includes 1.125" (29mm) thick and optional width back panel, 14" (356mm) wing panel and attachment hardware.
- Provides full support for one end of equal depth worksurface.
- All sides finished; top and bottom edges are not finished.

Specification Tips

- For use with other separately specified modular components.
- Stacked on top of modular storage credenza to provide support for separately specified modular credenza top.
- 6H T-Support panel for use with 1.5H modular storage unit(s).
- 12H T-Support panel for use with 1H modular storage unit(s).
- See Applications in Specification Guide.

To Order, Specify:

- 1) Product number.
- 2) Finish code (laminate or wood).
- 3) Laminate edge trim color (if laminate specified).

Height	Actual Overall Depth	Actual Width	Number	HPL A	B	Wood A	B
HPL — 0.5H							
6" (152mm)	18.88" (480mm)	15.06" (383mm)	XLFS-0619-SN	\$426.95	\$525.90		
	23.88" (607mm)		XLFS-0624-SN	446.50	587.35		
	29.88" (759mm)		XLFS-0630-SN	469.96	661.09		
	35.88" (911mm)		XLFS-0636-SN	493.42	734.83		
HPL — 1H							
11.56" (294mm)	18.88" (480mm)	15.06" (383mm)	XLFS-1219-SN	\$464.51	\$579.63		
	23.88" (607mm)		XLFS-1224-SN	484.06	641.08		
	29.88" (759mm)		XLFS-1230-SN	507.52	714.82		
	35.88" (911mm)		XLFS-1236-SN	530.98	788.56		
Wood — 0.5H							
6" (152mm)	18.88" (480mm)	15.06" (383mm)	XZFS-0619-SN			\$620.11	\$ 681.95
	23.88" (607mm)		XZFS-0624-SN			653.61	719.15
	29.88" (759mm)		XZFS-0630-SN			693.81	763.79
	35.88" (911mm)		XZFS-0636-SN			734.01	808.43
Wood — 1H							
11.56" (294mm)	18.88" (480mm)	15.06" (383mm)	XZFS-1219-SN			\$685.72	\$ 749.18
	23.88" (607mm)		XZFS-1224-SN			719.22	786.38
	29.88" (759mm)		XZFS-1230-SN			759.42	831.02
	35.88" (911mm)		XZFS-1236-SN			799.62	875.66

Modular Components

2H Support Panel

T-Support Panel

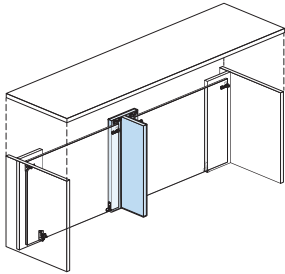

ULSX-SN
UXSX-SN
Class RA

Features

- Includes 1.125" (29mm) thick and 10.125" (257mm)W back panel, 10.125" (257mm) wing panel, glides and attachment hardware.
- Glides provide 2" (51mm) adjustment range.

Specification Tips

- For use with other separately specified modular components (worksurfaces, pedestals and hinged modesty panels) to assemble modular credenzas.
- Not for use with full overlay modesty panel.
- Provides intermediate support for worksurfaces with spans of 60" (1524mm) or greater of unsupported width and for use with hinged modesty panels.
- See Modular Components Application in Specification Guide.

To Order, Specify:

- 1) Product number.
- 2) Finish code (laminate or wood).
- 3) Laminate edge trim color (if laminate specified)

Height	Actual Overall Depth	Actual Width	Number	HPL A	B	Wood A	B
HPL							
28" (711mm)	10.06" (256mm)	10" (254mm)	ULSX-2811-SN	\$307.74	\$328.31		
Wood							
28" (711mm)	10.06" (256mm)	10" (254mm)	UXSX-2811-SN			\$465.21	\$517.72

Mid-Support Panel

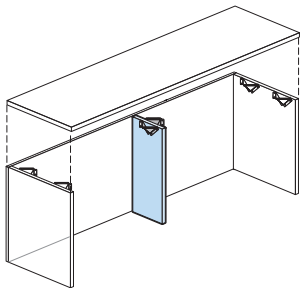

ULSS-S
UXSS-S
Class RA

Features

- Includes 1.125" (29mm) thick end panel, glides and attachment hardware.
- A notch at the upper rear corner is provided for wire routing.
- Glides provide 2" (51mm) adjustment range.

Specification Tips

- For use with other separately specified modular components (worksurfaces, end panels and L-support panels) and attached storage units to assemble credenza units.
- Used to provide support when unsupported span of worksurface is 60" (1524mm) or greater.
- 10.125" (257mm) mid-support panel recommended for use under worksurfaces 19" (483mm) and 24" (610mm)D.
- 14" (356mm) mid-support panel recommended for use under worksurfaces 30" (762mm)D and greater.
- 2" x 2" (51mm x 51mm) wireway notch located at top edge one side of support panel.
- See Modular Components Application in Specification Guide.

To Order, Specify:

- 1) Product number.
- 2) Finish code (laminate or wood).
- 3) Laminate edge trim color (if laminate specified).

Height	Actual Overall Depth	Actual Width	Number	HPL A	B	Wood A	B
HPL							
28" (711mm)	10" (254mm)	10" (254mm)	ULSS-2810-S	\$286.30	\$369.12		
	14.88" (378mm)		ULSS-2814-S	301.94	418.28		
Wood							
28" (711mm)	10" (254mm)	10" (254mm)	UXSS-2810-S			\$557.20	\$618.32
	14.88" (378mm)		UXSS-2814-S			584.00	648.08

Pedestal Attached

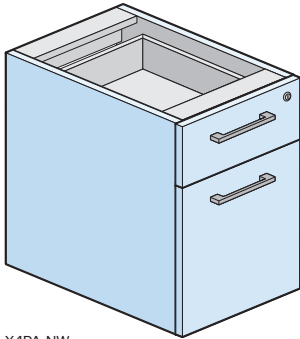
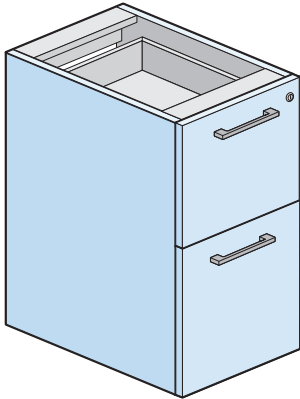
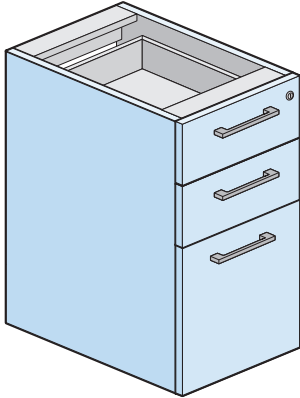

X4PA-NW
X6PA-NL
Class RA

Features

- Includes case, unfinished top, optional full finished back, .75"(19mm) thick end panels and attachment hardware.
- Unfinished tops of pedestals 21"(533mm) and deeper include a 3"(76mm) or greater horizontal wireway gap.
- Factory installed full back option adds .75"(19mm) to the overall pedestal depth.
- Letter width 15.5"(394mm) available on 22"(559mm)H or 28"(711mm)H pedestal.
- Legal width 18.75"(476mm) available on 28"(711mm)H pedestal.
- Box drawer with one black drawer divider per drawer and one black pencil tray per pedestal.
- File drawer with an integrated file hanging system.
- Drawer pull options:
 - Bar and Blade pulls available in powdercoat finishes.
 - Wing pulls available in powdercoat finishes.
 - Linear pulls are available in both powdercoat and satin nickel. Satin nickel will need to be specified.
 - Classic pulls are available in brushed nickel finish only. Finish code not required.
 - Finger pull option, available with Walnut double cut and Wood Group B finishes.
- Box and file drawers have full extension slides.
- One lock standard per pedestal.
- Lock plug is available in black or chrome.
- For lock options, refer to Lock Program section of the Accessories Price List.
- Glides provide 2"(51mm) adjustment range.
- Shipped assembled.

Specification Tips

- 18"(457mm)D pedestals for use under 19"(483mm)D worksurfaces.
- 23"(584mm)D pedestals for use under 24"(610mm)D worksurfaces.
- 29"(737mm)D pedestals for use under 30"(762mm)D worksurfaces.
- Non-handed design, allows for pedestal to be installed left or right on site.

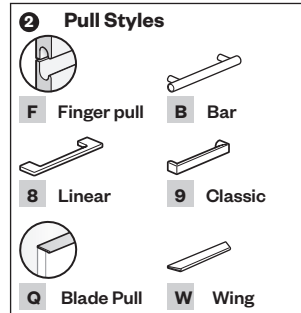

To Order, Specify:

1) Product number, including:

1 Pedestal Drawer Option:

22" Letter Width (18", 23" and 29" depths)

4 Box/File Black Miterfold

R Box/File Wood (add **\$133.65** list)

28" Letter Width (18", 23" and 29" depths)

5 Box/Box/File Black Miterfold

S Box/Box/File Wood (add **\$133.65** list)

6 File/File Black Miterfold

T File/File Wood (add **\$133.65** list)

22" Legal Width (18" and 23" depths)

7 Box/File Black Miterfold

U Box/File Wood (add **\$133.65** list)

28" Legal Width (18" and 23" depths)

8 Box/Box/File Black Miterfold

L Box/Box/File Wood (add **\$139.68** list)

9 File/File Black Miterfold

M File/File Wood (add **\$139.68** list)

2 Drawer Pull Option*:

F Finger pull (wood only) (add **\$160.00** list)

B Bar (add **\$85.00** list)

8 Linear

9 Classic (add **\$30.00** list)

Q Blade (add **\$120.00** list)

W Wing (add **\$160.00** list)

3 Back Option:

N No Back

Y Finished Laminate Back, (add **\$286.99** list)

Finished Wood Back (add **\$372.44** list)

4 Toe Kick Option:

N No Toe Kick

Y Toe Kick (add **\$150.00** list)

2) Finish code (laminate or wood).

3) Laminate edge trim color (if laminate specified).

4) Trim color for painted pull (if specified).

5) Trim color for lock (required).

*Price per pull.

Pedestal Attached

Height	Open Back Depth	Full Back Depth	Width	Number ① ② ③ ④	HPL A	B	Wood A	B
HPL — Letter Width								
22"(559mm)	18"(457mm)	18.75"(476mm)	15.5"(394mm)	X5PA-2218- SS L	\$ 1341.35	\$ 1534.91		
	23"(584mm)	23.75"(603mm)		X5PA-2223- SS L	1390.90	1584.46		
	29"(737mm)	29.75"(756mm)		X5PA-2229- SS L	1450.36	1643.92		
28"(711mm)	18"(457mm)	18.75"(476mm)	15.5"(394mm)	X5PA-2818- SS L	\$ 1551.60	\$ 1745.16		
	23"(584mm)	23.75"(603mm)		X5PA-2823- SS L	1601.15	1794.71		
	29"(737mm)	29.75"(756mm)		X5PA-2829- SS L	1660.61	1854.17		
HPL — Legal Width								
22"(559mm)	18"(457mm)	18.75"(476mm)	15.5"(394mm)	X5PA-2218- SS L	\$1620.26	\$ 1813.82		
	23"(584mm)	23.74"(603mm)		X5PA-2223- SS L	1669.81	1863.37		
28"(711mm)	18"(457mm)	18.75"(476mm)	18.75"(476mm)	X5PA-2818- SS L	\$1830.51	\$2024.07		
	23"(584mm)	23.75"(603mm)		X5PA-2823- SS L	1880.06	2073.62		
Wood — Letter Width								
22"(559mm)	18"(457mm)	18.75"(476mm)	15.5"(394mm)	X4PA-2218- SS W			\$ 2015.09	\$ 2267.49
	23"(584mm)	23.75"(603mm)		X4PA-2223- SS W			2064.64	2322.39
	29"(737mm)	29.75"(756mm)		X4PA-2229- SS W			2124.10	2388.27
28"(711mm)	18"(457mm)	18.75"(476mm)	15.5"(394mm)	X4PA-2818- SS W			\$ 2225.34	\$ 2477.74
	23"(584mm)	23.75"(603mm)		X4PA-2823- SS W			2274.89	2532.64
	29"(737mm)	29.75"(756mm)		X4PA-2829- SS W			2334.35	2598.52
Wood — Legal Width								
22"(559mm)	18"(457mm)	18.75"(476mm)	15.5"(394mm)	X4PA-2218- SS W			\$ 2015.09	\$ 2267.49
	23"(584mm)	23.74"(603mm)		X4PA-2223- SS W			2064.64	2322.39
28"(711mm)	18"(457mm)	18.75"(476mm)	18.75"(476mm)	X4PA-2818- SS W			\$2504.25	\$2786.33
	23"(584mm)	23.75"(603mm)		X4PA-2823- SS W			2553.80	2841.23

Pedestal Mobile

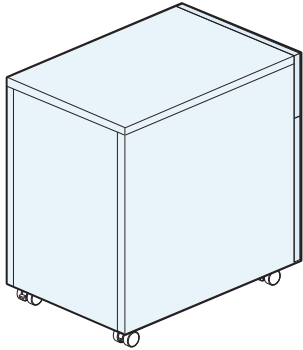
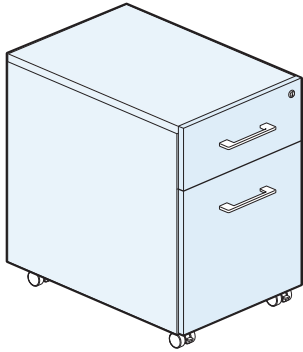

X4PM-BW
X7PM-BW
Class RA

Features

- Includes case, finished top, finished back and casters.
- Box drawer with one black drawer divider per drawer and one black pencil tray per pedestal.
- File drawer with an integrated file hanging system.
- Drawer pull options:
 - Bar and Blade pulls available in powdercoat finishes.
 - Wing pulls available in powdercoat finishes.
 - Linear pulls are available in both powdercoat and satin nickel. Satin nickel will need to be specified.
 - Classic pulls are available in brushed nickel finish only. Finish code not required.
 - Finger pull option, available with Walnut double cut and Wood Group B finishes.
- Box and file drawers have full extension slides.
- One lock standard per pedestal.
- Lock plug is available in black or chrome.
- For lock options, refer to Lock Program section of the Accessories Price List.
- Casters: four black swivel with front two locking.
- Shipped assembled; casters field installed.

Specification Tips

- Not designed to fit flush under a 19"(483mm)D worksurface.
- Standard with toe kick.

To Order, Specify:

1) Product number, including:

1 Pedestal Drawer Option:

- 4** Box/File Black Miterfold
- R** Box/File Wood (add **\$133.65** list)

2 Drawer Pull Option*:

- F** Finger pull (wood only) (add **\$160.00** list)
- B** Bar (add **\$85.00** list)
- 8** Linear
- 9** Classic (add **\$30.00** list)
- Q** Blade (add **\$120.00** list)
- W** Wing (add **\$160.00** list)

- 2) Finish code (laminate or wood).
- 3) Laminate edge trim color (if laminate specified).
- 4) Trim color for painted pull (if specified).
- 5) Trim color for lock (required).

*Price per pull.

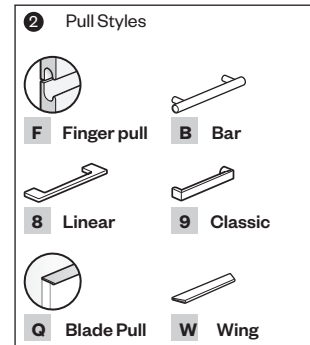

Height	Depth	Width	Number ①②	HPL		Wood	
				A	B	A	B
HPL							
21.5"(546mm)	21"(533mm)	15.5"(394mm)	X5PM-2221-■ ■ SSBL	\$1760.52	\$1954.08		
Wood							
21.5"(546mm)	21"(533mm)	15.5"(394mm)	X4PM-2221-■ ■ SSBW			\$2509.12	\$2764.73

Pedestal Storage Cushion

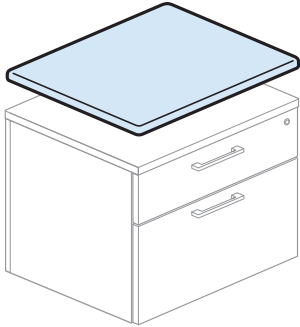

Feature

- Includes one cushion with removable attachment.

Specification Tips

- Lower Storage Cushion must be used with a separately specified Credenza Top.
- Lower Storage Cushion may be used with lower storage units with no back or finished back option.
- Mobile Pedestal includes a finished top; pedestal cushion is used directly on pedestal top.
- Not for use with X or V Series lower storage.
- Cushion is full depth; plan accordingly when used between upper and lower storage with a tackboard.

To Order, Specify:

- 1) Product number.
- 2) Fabric finish.

XZSC-2116-FA
Class RA

For Use With	Actual Height	Nominal Depth	Actual Width	Number	Fabric				
					A	B	C	D	E
Mobile Pedestal	1.25"(32mm)	21"(533mm)	15.5"(394mm)	XZSC-2116-FA	\$395.84	\$429.49	\$434.45	\$439.72	\$444.99
1.5H or 2H Lower Storage		19"(483mm)	30"(762mm)	XZSC-1930-FA	482.42	527.77	544.43	570.76	590.07
			36"(914mm)	XZSC-1936-FA	524.60	575.65	598.01	634.60	660.75
			42"(1067mm)	XZSC-1942-FA	566.78	623.53	651.59	698.44	731.43
1.5H or 2H Lower Storage	1.25"(32mm)	24"(610mm)	30"(762mm)	XZSC-2430-FA	\$ 537.92	\$590.77	\$ 614.93	\$654.76	\$683.07
			36"(914mm)	XZSC-2436-FA	591.20	651.25	682.61	735.40	772.35
			42"(1067mm)	XZSC-2442-FA	644.48	711.73	750.29	816.04	861.63

Lateral File

Attached Open Shelf

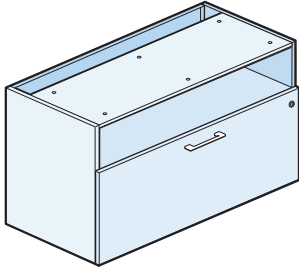

X4FV-LW
X5FV-LW
Class RA

Features

- Includes unfinished top, optional full finished back, adjustable shelf for 2H unit, glides and attachment hardware.
- Unfinished top for 23"(584mm)D storage unit includes a 5"(127mm) horizontal wireway gap. The 18"(457mm)D storage unit has no gap.
- Drawer pull options:
 - Bar and Blade pulls available in powdercoat finishes.
 - Wing pulls available in powdercoat finishes.
 - Linear pulls are available in both powdercoat and satin nickel. Satin nickel will need to be specified.
 - Classic pulls are available in brushed nickel finish only. Finish code not required.
 - Finger pull option available with Walnut double cut and Wood Group B finishes.
- Adjustable shelf depth for 2H sized to allow .5"(13mm) wireway at the rear of the cabinet.
- One .75"(19mm) thick adjustable shelf for 2H has ±1.25"(32mm) adjustment range.
- Factory installed full back option adds .75"(19mm) to the overall storage cabinet depth.
- Glides provide 2"(51mm) adjustment range.
- Shipped assembled.

Specification Tips

- Storage cabinet used as support for upper storage requires either a finished back or overlay modesty panel.
- 18"(457mm)D storage cabinets for use under 19"(483mm)D worksurfaces.
- 23"(584mm) and 23.75"(603mm)D storage cabinets for use under 24"(610mm)D worksurfaces.
- Separately specified credenza top may be added to attached storage cabinet with finished back option for use as freestanding unit.
- Side to side bar is specified separately.

To Order, Specify:

- 1) Product number, including:
 - 1 **File Drawer Option:**
 - S** Black Miterfold
 - W** Wood (add **\$143.69** list)
 - 2 **Drawer Pull Option*:**
 - F** Finger pull (wood only) (add **\$160.00** list)
 - B** Bar (add **\$85.00** list)
 - 8** Linear
 - 9** Classic (add **\$30.00** list)
 - Q** Blade (add **\$120.00** list)
 - W** Wing (add **\$160.00** list)
 - 3 **Back Option:**
 - N** No Back
 - Y** Finished Back (add **\$384.74** list)
 - 4 **Toe Kick Option:**
 - N** No Toe Kick
 - Y** Toe Kick (add **\$198.00** list)
- 2) Finish code (laminate or wood).
- 3) Laminate edge trim color (if laminate specified).
- 4) Trim color for painted pull (if specified).
- 5) Trim color for lock (required).

*Price per pull.

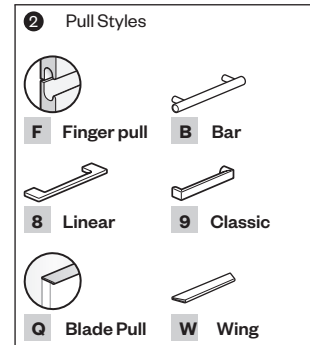

Lateral File

Attached Open Shelf

Height	Open Back Depth	Full Back Depth	Width	Number	①	②	③	④	HPL A	B	Wood A	B
HPL — 1.5H												
21.5"(546mm)	18"(457mm)	18.75"(476mm)	30"(762mm)	X5FV-1830-N	■	■	SS	■	LL	\$ 1557.46	\$ 1795.91	
			36"(914mm)	X5FV-1836-N	■	■	SS	■	LL	1760.48	1998.93	
23"(584mm)	23.75"(603mm)	30"(762mm)	30"(762mm)	X5FV-2330-N	■	■	SS	■	LL	\$ 1680.27	\$ 1918.72	
			36"(914mm)	X5FV-2336-N	■	■	SS	■	LL	1883.29	2121.74	
Wood — 1.5H												
21.5"(546mm)	18"(457mm)	18.75"(476mm)	30"(762mm)	X4FV-1830-N	■	■	SS	■	LW		\$ 2351.46	\$ 2630.93
			36"(914mm)	X4FV-1836-N	■	■	SS	■	LW		2613.15	2922.74
23"(584mm)	23.75"(603mm)	30"(762mm)	30"(762mm)	X4FV-2330-N	■	■	SS	■	LW		\$ 2474.27	\$ 2768.39
			36"(914mm)	X4FV-2336-N	■	■	SS	■	LW		2735.96	3060.20

Lateral File

Attached

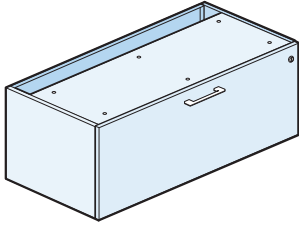

1H
X4F1-LW
X6F1-LL

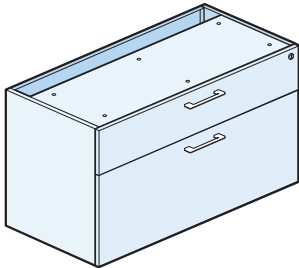

1.5H
X4FB-LW
X6FB-LL

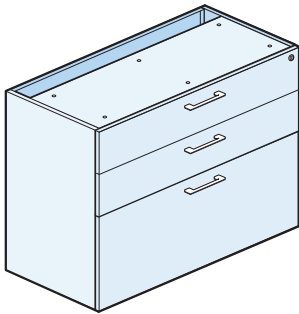

2H
X4FP-LW
X6FP-LL

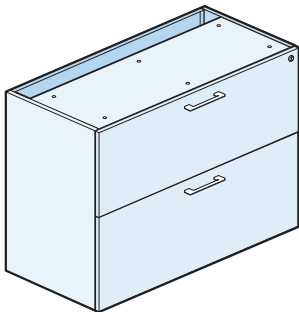

2H
X4FA-LW
X6FA-LL
Class RA

Features

- Includes case, unfinished top, optional full finished back, .75"(19mm) thick end panels, glides and attachment hardware.
- Unfinished top of 23"(584mm) lateral file includes a 3"(76mm) horizontal wireway gap.
- Factory installed finished back option adds .75"(19mm) to the overall lateral file depth.
- File drawer with an integrated file hanging system.
- Two file hanging bars included per file drawer.
- File drawers have full extension slides with integrated anti-tip interlock feature.
- Drawer pull options:
 - Bar and Blade pulls available in powdercoat finishes.
 - Wing pulls available in powdercoat finishes.
 - Linear pulls are available in both powdercoat and satin nickel. Satin nickel will need to be specified.
 - Classic pulls are available in brushed nickel finish only. Finish code not required.
 - Finger pull option available with Walnut double cut and Wood Group B finishes.
- One lock standard per lateral file; includes dual lock bar system.
- Lock plug is available in black or chrome.
- For lock options, refer to Lock Program section of the Accessories Price List.
- Glides provide 2"(51mm) adjustment range.
- 42"(1067mm) width files available in laminate and wood only.
- Shipped assembled.

Specification Tips

- 18"(457mm) and 18.75"(476mm)D lateral files for use under 19"(483mm)D worksurfaces.
- 23"(584mm) and 23.75"(603mm)D lateral files for use under 24"(610mm)D worksurfaces.
- 2H lateral files can be incorporated into a preconfigured return with a pedestal. No back option must be specified.
- See Planning Modular Components in Specification Guide for details.
- Side to side bar is specified separately.

To Order, Specify:

1) Product number, including:

1 File Drawer Option:

- S** Black Miterfold
- W** Wood
 - 1H (add **\$94.42** list)
 - 1.5H (add **\$143.69** list)
 - 2H (add **\$190.89** list)

2 Drawer Pull Option*:

- F** Finger pull (wood only) (add **\$160.00** list)
- B** Bar (add **\$85.00** list)
- 8** Linear
- 9** Classic (add **\$30.00** list)
- Q** Blade (add **\$120.00** list)
- W** Wing (add **\$160.00** list)

3 Back Option:

- N** No Back
- Y** Finished Back
 - 1H (add **\$371.68** list)
 - 1.5H (add **\$384.74** list)
 - 2H (add **\$396.21** list)

4 Toe Kick Option:

- N** No Toe Kick
- Y** Toe Kick (add **\$198.00** list)

2) Finish code (laminate or wood).

3) Laminate edge trim color (if laminate specified).

4) Trim color for painted pull (if specified).

5) Trim color for lock (required).

*Price per pull.

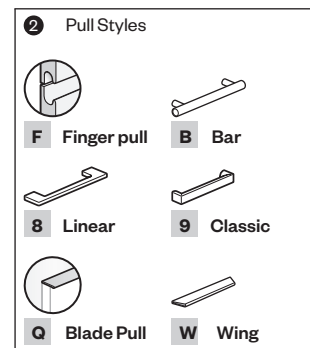

Lateral File

Attached

Height	Open Back Depth	Full Back Depth	Width	Number	①	②	③	④	HPL A	B	Wood A	B
HPL — 1H File												
15.1875"(386mm)	18"(457mm)	18.75"(476mm)	30"(762mm)	X5F1-1830-N	SS	LL			\$ 1399.29	\$ 1625.10		
			36"(914mm)	X5F1-1836-N	SS	LL			1602.31	1828.12		
			42"(1067mm)	X5F1-1842-N	SS	LL			1805.33	2031.14		
23"(584mm)	23.75"(603mm)	30"(762mm)	X5F1-2330-N	SS	LL			\$ 1522.10	\$ 1747.91			
			36"(914mm)	X5F1-2336-N	SS	LL			1725.12	1950.93		
			42"(1067mm)	X5F1-2342-N	SS	LL			1928.14	2153.95		
HPL — 1.5H Box/File												
21.5"(546mm)	18"(457mm)	18.75"(476mm)	30"(762mm)	X5FB-1830-N	SS	LL			\$ 1557.46	\$ 1795.91		
			36"(914mm)	X5FB-1836-N	SS	LL			1760.48	1998.93		
			42"(1067mm)	X5FB-1842-N	SS	LL			1963.50	2201.95		
23"(584mm)	23.75"(603mm)	30"(762mm)	X5FB-2330-N	SS	LL			\$ 1680.27	\$ 1918.72			
			36"(914mm)	X5FB-2336-N	SS	LL			1883.29	2121.74		
			42"(1067mm)	X5FB-2342-N	SS	LL			2086.31	2324.76		
HPL — 2H File/File												
28"(711mm)	18"(457mm)	18.75"(476mm)	30"(762mm)	X5FA-1830-N	SS	LL			\$ 1801.58	\$2059.56		
			36"(914mm)	X5FA-1836-N	SS	LL			2004.60	2262.58		
			42"(1067mm)	X5FA-1842-N	SS	LL			2207.62	2465.60		
23"(584mm)	23.75"(603mm)	30"(762mm)	X5FA-2330-N	SS	LL			\$ 1924.39	\$ 2182.37			
			36"(914mm)	X5FA-2336-N	SS	LL			2127.41	2385.39		
			42"(1067mm)	X5FA-2342-N	SS	LL			2330.43	2588.41		
HPL — 2H Box/Box/File												
28"(711mm)	18"(457mm)	18.75"(476mm)	30"(762mm)	X5FP-1830-N	SS	LL			\$ 1801.58	\$2059.56		
			36"(914mm)	X5FP-1836-N	SS	LL			2004.60	2262.58		
			42"(1067mm)	X5FP-1842-N	SS	LL			2207.62	2465.60		
23"(584mm)	23.75"(603mm)	30"(762mm)	X5FP-2330-N	SS	LL			\$ 1924.39	\$ 2182.37			
			36"(914mm)	X5FP-2336-N	SS	LL			2127.41	2385.39		
			42"(1067mm)	X5FP-2342-N	SS	LL			2330.43	2588.41		
Wood — 1H File												
15.1875"(386mm)	18"(457mm)	18.75"(476mm)	30"(762mm)	X4F1-1830-N	SS	LW					\$2068.15	\$2305.05
			36"(914mm)	X4F1-1836-N	SS	LW					2329.84	2596.86
			42"(1067mm)	X4F1-1842-N	SS	LW					2591.53	2888.67
23"(584mm)	23.75"(603mm)	30"(762mm)	X4F1-2330-N	SS	LW					\$ 2190.96	\$2442.51	
			36"(914mm)	X4F1-2336-N	SS	LW					2452.65	2734.32
			42"(1067mm)	X4F1-2342-N	SS	LW					2714.34	3026.13
Wood — 1.5H Box/File												
21.5"(546mm)	18"(457mm)	18.75"(476mm)	30"(762mm)	X4FB-1830-N	SS	LW					\$2505.41	\$ 2784.88
			36"(914mm)	X4FB-1836-N	SS	LW					2767.10	3076.69
			42"(1067mm)	X4FB-1842-N	SS	LW					3028.79	3368.50
23"(584mm)	23.75"(603mm)	30"(762mm)	X4FB-2330-N	SS	LW					2628.22	\$2922.34	
			36"(914mm)	X4FB-2336-N	SS	LW					2889.91	3214.15
			42"(1067mm)	X4FB-2342-N	SS	LW					3151.60	3505.96
Wood — 2H File/File												
28"(711mm)	18"(457mm)	18.75"(476mm)	30"(762mm)	X4FA-1830-N	SS	LW					\$ 2787.99	\$3084.15
			36"(914mm)	X4FA-1836-N	SS	LW					3049.68	3375.96
			42"(1067mm)	X4FA-1842-N	SS	LW					3311.37	3667.77
23"(584mm)	23.75"(603mm)	30"(762mm)	X4FA-2330-N	SS	LW					\$ 2910.80	\$ 3221.61	
			36"(914mm)	X4FA-2336-N	SS	LW					3172.49	3513.42
			42"(1067mm)	X4FA-2342-N	SS	LW					3434.18	3434.18
Wood — 2H Box/Box/File												
28"(711mm)	18"(457mm)	18.75"(476mm)	30"(762mm)	X4FP-1830-N	SS	LW					\$ 2787.99	\$3084.15
			36"(914mm)	X4FP-1836-N	SS	LW					3049.68	3375.96
			42"(1067mm)	X4FP-1842-N	SS	LW					3311.37	3667.77
23"(584mm)	23.75"(603mm)	30"(762mm)	X4FP-2330-N	SS	LW					\$ 2910.80	\$ 3221.61	
			36"(914mm)	X4FP-2336-N	SS	LW					3172.49	3513.42
			42"(1067mm)	X4FP-2342-N	SS	LW					3434.18	3805.23

Storage Unit

Attached

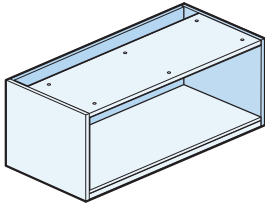

1H
X4N1-NN
X6N1-NN

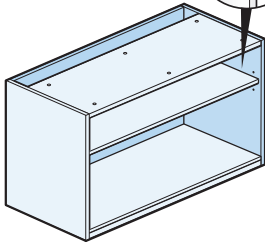
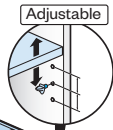

1.5H
X4NB-NN
X6NB-NN

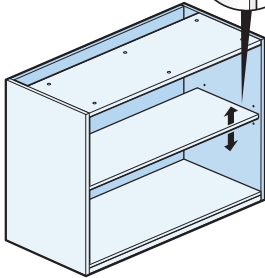
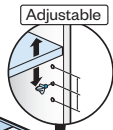

2H
X4N2-NN
X6N2-NN
Class RA

Features

- Includes unfinished top, optional full finished back, adjustable shelf for 2H unit, glides and attachment hardware.
- Unfinished top for 23"(584mm)D storage unit includes a 5"(127mm) horizontal wireway gap. The 18"(457mm)D storage unit has no gap.
- Adjustable shelf depth for 2H sized to allow .5"(13mm) wireway at the rear of the cabinet.
- One .75"(19mm) thick adjustable shelf for 2H has ±1.25"(32mm) adjustment range.
- Proud Back Finished option adds .75"(19mm) to the overall storage cabinet depth.
- Glides provide 2"(51mm) adjustment range.
- 42"(1067mm) width available in laminate and wood, and has fixed shelves.
- Shipped assembled.

Specification Tips

- Storage unit used as support for upper storage requires either a finished back or overlay modesty panel.
- 18"(457mm)D storage units for use under 19"(483mm)D worksurfaces.
- 23"(584mm)D storage units for use under 24"(610mm)D worksurfaces.
- Separately specified credenza top may be added to attached storage unit with finished back option for use as freestanding unit when back is exposed, or if unit is visible from the side.

To Order, Specify:

1) Product number, including:

1 Back Option:

N Inset Back Unfinished

L Proud Back Finished Laminate

1H (add **\$371.68** list)

1.5H (add **\$384.74** list)

2H (add **\$361.37** list)

W Proud Back Finished Wood

1H (add **\$371.68** list)

1.5H (add **\$384.74** list)

2H (add **\$431.42** list)

2 Toe Kick Option:

N No Toe Kick

Y Toe Kick (add **\$198.00** list)

2) Finish code (laminate or wood).

3) Laminate edge trim color (if laminate specified).

Storage Unit

Attached

Height	Open Back Depth	Finished Back Depth	Width	Number	①	②	HPL A	B	Wood A	B
HPL — 1H										
15.1875"(386mm)	18"(457mm)	18.75"(476mm)	30"(762mm)	X5N1-1830-NS	NN		\$ 1218.25	\$ 1391.85		
			36"(914mm)	X5N1-1836-NS	NN		1301.19	1474.79		
			42"(1067mm)	X5N1-1842-NS	NN		1384.13	1557.73		
23"(584mm)	23.75"(603mm)	30"(762mm)	X5N1-2330-NS	NN		\$ 1307.82	\$ 1481.42			
			36"(914mm)	X5N1-2336-NS	NN		1390.76	1564.36		
			42"(1067mm)	X5N1-2342-NS	NN		1473.70	1647.30		
HPL — 1.5H										
21.5"(546mm)	18"(457mm)	18.75"(476mm)	30"(762mm)	X5NB-1830-NS	NN		\$ 1551.39	\$ 1595.70		
			36"(914mm)	X5NB-1836-NS	NN		1644.83	1678.64		
			42"(1067mm)	X5NB-1842-NS	NN		1738.27	1761.58		
23"(584mm)	23.75"(603mm)	30"(762mm)	X5NB-2330-NS	NN		\$1640.96	\$ 1685.27			
			36"(914mm)	X5NB-2336-NS	NN		1734.40	1768.21		
			42"(1067mm)	X5NB-2342-NS	NN		1827.84	1851.15		
HPL — 2H										
28"(711mm)	18"(457mm)	18.75"(476mm)	30"(762mm)	X5N2-1830-NS	NN		\$1534.69	\$ 1668.69		
			36"(914mm)	X5N2-1836-NS	NN		1645.83	1779.83		
			42"(1067mm)	X5N2-1842-NS	NN		1756.97	1890.97		
23"(584mm)	23.75"(603mm)	30"(762mm)	X5N2-2330-NS	NN		\$1644.17	\$ 1778.17			
			36"(914mm)	X5N2-2336-NS	NN		1755.31	1889.31		
			42"(1067mm)	X5N2-2342-NS	NN		1866.45	2000.45		
Wood — 1H										
15.1875"(386mm)	18"(457mm)	18.75"(476mm)	30"(762mm)	X4N1-1830-NS	NN				\$ 2130.19	\$ 2367.31
			36"(914mm)	X4N1-1836-NS	NN				2281.76	2535.78
			42"(1067mm)	X4N1-1842-NS	NN				2433.33	2704.25
23"(584mm)	23.75"(603mm)	30"(762mm)	X4N1-2330-NS	NN				\$2298.22	\$ 2553.99	
			36"(914mm)	X4N1-2336-NS	NN				2449.79	2722.46
			42"(1067mm)	X4N1-2342-NS	NN				2601.36	2890.93
Wood — 1.5H										
21.5"(546mm)	18"(457mm)	18.75"(476mm)	30"(762mm)	X4NB-1830-NS	NN				\$2356.31	\$ 2595.03
			36"(914mm)	X4NB-1836-NS	NN				2509.97	2752.90
			42"(1067mm)	X4NB-1842-NS	NN				2663.63	2910.77
23"(584mm)	23.75"(603mm)	30"(762mm)	X4NB-2330-NS	NN				\$2445.88	\$ 2684.60	
			36"(914mm)	X4NB-2336-NS	NN				2599.54	2842.47
			42"(1067mm)	X4NB-2342-NS	NN				2753.20	3000.34
Wood — 2H										
28"(711mm)	18"(457mm)	18.75"(476mm)	30"(762mm)	X4N2-1830-NS	NN				\$ 2410.10	\$ 2680.10
			36"(914mm)	X4N2-1836-NS	NN				2521.24	2791.24
			42"(1067mm)	X4N2-1842-NS	NN				2632.38	2902.38
23"(584mm)	23.75"(603mm)	30"(762mm)	X4N2-2330-NS	NN				\$ 2519.58	\$ 2789.58	
			36"(914mm)	X4N2-2336-NS	NN				2630.72	2900.72
			42"(1067mm)	X4N2-2342-NS	NN				2741.86	3011.86

Storage Unit

1.5H Attached Open for use with Convergent Worktop

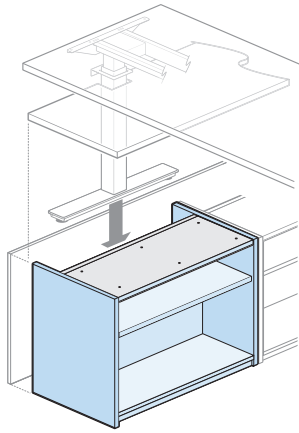

X5PB-1830
X4PB-1860
Class RA

Features

- Includes case with optional finished back panel, 5"(127mm)D full height wire way and adjustable shelf.
- Adjustable self depth sized to allow 0.5"(13mm) wireway at the rear of the cabinet. 42"(1067mm) units have a fixed shelf.

Specification Tips

- Attached lower storage units are used to design a modular storage credenza.
- Designed to be attached to adjacent modular lower storage for stability.
- Back of storage unit has a 5"(127mm) deep full height open wireway intended to conceal a height adjustable T-Leg included with a Height Adjustable Convergent Worktop or provide access to wall power.
- Extended side panel is used to close the gap between the wall and the unit when a back panel is not specified.
- May be used to support a Convergent Worktop - For use with 1.5H Storage (fixed height convergent worktop with stanchion).
- Requires a separately specified Credenza Top.
- The optional finished back panel is .75"(19mm) thick and will increase the overall depth of the attached storage unit.

To Order, Specify:

No Back

- 1) Product number, including:

1 Toe Kick Option:

- N No Toe Kick
- Y Toe Kick (add **\$198.00** list)

- 2) Laminate surface color or wood finish for case.

- 3) Edge trim color (laminate only).

With Finished Back

- 1) Product number, including:

1 Toe Kick Option:

- N No Toe Kick
- Y Toe Kick (add **\$198.00** list)

- 2) Laminate surface color or wood finish for case and back.

- 3) Edge trim color (laminate only).

Depth	Width	Number	1	HPL		Wood	
				A	B	A	B
HPL — No back							
18"(457mm)	30"(762mm)	X5PB-1830-NSNN		\$1376.46	\$1420.77		
	36"(914mm)	X5PB-1836-NSNN		1469.90	1503.71		
	42"(1067mm)	X5PB-1842-NSNN		1563.34	1586.65		
23"(584mm)	30"(762mm)	X5PB-2330-NSNN		\$1479.62	\$1523.93		
	36"(914mm)	X5PB-2336-NSNN		1573.06	1606.87		
	42"(1067mm)	X5PB-2342-NSNN		1666.50	1689.81		
HPL — With back							
18"(457mm)	30"(762mm)	X5PB-1830-NSLN		\$1761.23	\$1805.54		
	36"(914mm)	X5PB-1836-NSLN		1854.67	1888.48		
	42"(1067mm)	X5PB-1842-NSLN		1948.11	1971.42		
23"(584mm)	30"(762mm)	X5PB-2330-NSLN		\$1864.39	\$1908.70		
	36"(914mm)	X5PB-2336-NSLN		1957.83	1991.64		
	42"(1067mm)	X5PB-2342-NSLN		2051.27	2074.58		
HPL — With extended back side panel							
18"(457mm)	30"(762mm)	X5PB-1830-NSEN		\$1376.46	\$1420.77		
	36"(914mm)	X5PB-1836-NSEN		1469.90	1503.71		
	42"(1067mm)	X5PB-1842-NSEN		1563.34	1586.65		
23"(584mm)	30"(762mm)	X5PB-2330-NSEN		\$1479.62	\$1523.93		
	36"(914mm)	X5PB-2336-NSEN		1573.06	1606.87		
	42"(1067mm)	X5PB-2342-NSEN		1666.50	1689.81		
Wood — No back							
18"(457mm)	30"(762mm)	X4PB-1830-NSWN				\$2678.23	\$2917.11
	36"(914mm)	X4PB-1836-NSWN				2831.89	3074.98
	42"(1067mm)	X4PB-1842-NSWN				2985.55	3232.85
23"(584mm)	30"(762mm)	X4PB-2330-NSWN				\$2781.39	\$3178.14
	36"(914mm)	X4PB-2336-NSWN				2935.05	2793.37
	42"(1067mm)	X4PB-2342-NSWN				3088.71	3336.01
Wood — With back							
18"(457mm)	30"(762mm)	X4PB-1830-NSNN				\$2293.46	\$2532.34
	36"(914mm)	X4PB-1836-NSNN				2447.12	2690.21
	42"(1067mm)	X4PB-1842-NSNN				2600.78	2848.08
23"(584mm)	30"(762mm)	X4PB-2330-NSNN				\$2396.62	\$2635.50
	36"(914mm)	X4PB-2336-NSNN				2550.28	2793.37
	42"(1067mm)	X4PB-2342-NSNN				2703.94	2951.24
Wood — With extended back side panel							
18"(457mm)	30"(762mm)	X4PB-1830-NSEN				\$2293.46	\$2532.34
	36"(914mm)	X4PB-1836-NSEN				2447.12	2690.21
	42"(1067mm)	X4PB-1842-NSEN				2600.78	2848.08
23"(584mm)	30"(762mm)	X4PB-2330-NSEN				\$2396.62	\$2635.50
	36"(914mm)	X4PB-2336-NSEN				2550.28	2793.37
	42"(1067mm)	X4PB-2342-NSEN				2703.94	2951.24

Storage Unit

1.5 or 2H Doors

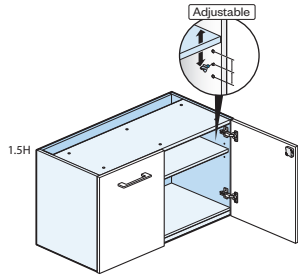

1.5H
X6HB
X4HB

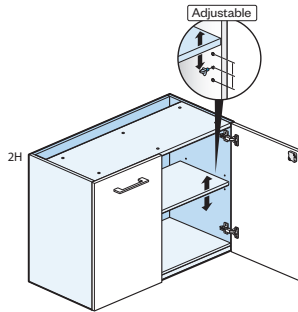

2H
X6H2
X4H2
Class RA

Features

- Includes case, unfinished top, optional full finished back, adjustable shelf, doors with concealed hinges, glides, and attachment hardware.
- Unfinished top for 23"(584mm)D storage unit includes a 5"(127mm) horizontal wireway gap. The 18"(457mm)D storage unit has no gap.
- One .75"(19mm) thick adjustable shelf has ±1.25"(32mm) adjustment range.
- Adjustable shelf depth sized to allow .5"(13mm) wireway at the rear of the cabinet. 42"(1067mm) units have a fixed shelf.
- Factory installed finished wood back option adds .75"(19mm) to the overall storage cabinet depth.
- Drawer pull options:
 - Bar pulls available in powdercoat finishes, indicates a door equipped with a touch latch.
 - Wing pulls available in powdercoat finishes.
 - Linear pulls are available in both powdercoat and satin nickel. Satin nickel will need to be specified.
 - Classic pulls are available in brushed nickel finish only. Finish code not required.
 - Touch latch option, indicates a door equipped with a touch latch.
- Optional lock available; lock plug available in black or chrome.
- For lock options, refer to Lock Program section of the Accessories Price List.
- Glides provide 2"(51mm) adjustment range.
- Shipped assembled.

Specification Tips

- 18"(457mm)D storage units for use under 19"(483mm)D worksurfaces.
- 23"(584mm)D storage units for use under 24"(610mm)D worksurfaces.
- Separately specified worksurface may be added to attached storage unit with finished back option for use as freestanding 2H.

To Order, Specify:

1) Product number, including:

1 Door Pull Option*:

- F** Touch latch (add **\$160.00** list)
- B** Bar (add **\$85.00** list)
- 8** Linear
- 9** Classic (add **\$30.00** list)
- W** Wing (add **\$160.00** list)

2 Back Option:

- N** No Finished Back
- L** Finished Laminate Back (add **\$340.08** list)
- W** Finished Wood Back (add **\$416.10** list)

3 Lock Option:

- N** No Lock
- L** Lock (add **\$177.50** list)

4 Toe Kick Option:

- N** No Toe Kick
- Y** Toe Kick (add **\$198.00** list)

- 2) Finish code (laminate or wood).
- 3) Laminate edge trim color (if laminate specified).
- 4) Trim color for painted pull (if specified).
- 5) Trim color for lock (if specified).

*Price per pull.

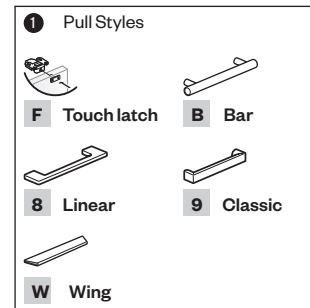

Storage Unit

1.5 or 2H Doors

Height	Inner Back Depth	Finished Back Depth	Width	Number	①	②	③	④	HPL A	B	Wood A	B
HPL — 1.5H												
28"(711mm)	18"(457mm)	18.75"(476mm)	30"(762mm)	X5HB-1830-	S			L	\$ 1523.52	\$ 1671.21		
			36"(914mm)	X5HB-1836-	S			L	1565.00	1712.69		
			42"(1067mm)	X5HB-1842-	S			L	1606.48	1754.17		
23"(584mm)	23.75"(603mm)	30"(762mm)	X5HB-2330-	S			L	\$ 1621.39	\$ 1769.08			
			36"(914mm)	X5HB-2336-	S			L	1662.87	1810.56		
			42"(1067mm)	X5HB-2342-	S			L	1704.35	1852.04		
HPL — 2H												
28"(711mm)	18"(457mm)	18.75"(476mm)	30"(762mm)	X5H2-1830-	S			L	\$ 1846.41	\$ 1994.10		
			36"(914mm)	X5H2-1836-	S			L	1949.26	2096.95		
			42"(1067mm)	X5H2-1842-	S			L	2052.11	2199.80		
23"(584mm)	23.75"(603mm)	30"(762mm)	X5H2-2330-	S			L	\$ 1944.28	\$ 2091.97			
			36"(914mm)	X5H2-2336-	S			L	2047.13	2194.82		
			42"(1067mm)	X5H2-2342-	S			L	2149.98	2297.67		
Wood — 1.5H												
28"(711mm)	18"(457mm)	18.75"(476mm)	30"(762mm)	X4HB-1830-	S			W			\$ 2495.75	\$ 2820.21
			36"(914mm)	X4HB-1836-	S			W			2545.23	2882.55
			42"(1067mm)	X4HB-1842-	S			W			2586.71	2924.03
23"(584mm)	23.75"(603mm)	30"(762mm)	X4HB-2330-	S			W			\$ 2615.66	\$ 2953.76	
			36"(914mm)	X4HB-2336-	S			W			2665.14	3016.10
			42"(1067mm)	X4HB-2342-	S			W			2706.62	3057.58
Wood — 2H												
28"(711mm)	18"(457mm)	18.75"(476mm)	30"(762mm)	X4H2-1830-	S			W			\$ 2818.64	\$ 3143.10
			36"(914mm)	X4H2-1836-	S			W			2929.49	3266.81
			42"(1067mm)	X4H2-1842-	S			W			3032.34	3369.66
23"(584mm)	23.75"(603mm)	30"(762mm)	X4H2-2330-	S			W			\$ 2938.55	\$ 3276.65	
			36"(914mm)	X4H2-2336-	S			W			3049.40	3400.36
			42"(1067mm)	X4H2-2342-	S			W			3152.25	3503.21

Storage Unit

1.5H Attached Sliding Door – 18” Depth

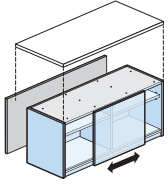

48"-72" widths
X6SB-1848
X4SB-1848

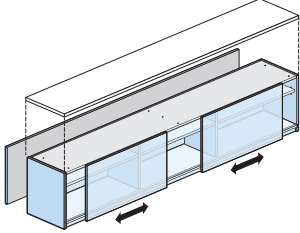

78"-108" widths
X6SB-1848
X4SB-1848
Class RA

Features

- Includes case with optional back panel, non-locking sliding door(s) and adjustable shelf.

Specification Tips

- May be used as a stand alone unit.
- May be used adjacent to applicable attached lower storage or modular components to design a credenza storage unit.
- Not for use with a Height Adjustable Convergent Worktop.
- May be used to support a Convergent Worktop - For use with 1.5H Storage (fixed height convergent worktop with stanchion).
- Requires a separately specified Credenza Top.
- The optional finished back panel is .75"(19mm) thick and will increase the overall depth of the attached storage unit.

To Order, Specify:

No Back

- 1) Product number.
- 2) Laminate surface color or wood finish for case and door.
- 3) Edge trim color (laminated only).

With Finished Back

- 1) Product number.
- 2) Laminate surface color or wood finish for case, back and door.
- 3) Edge trim color (laminated only).

Storage Unit

1.5H Attached Sliding Door – 18” Depth

Depth	Width	Number	Number of Door(s) and Divider(s)	Shelf(s)	HPL A	B	Wood A	B
HPL Door — No back								
18”(457mm)	48”(1219mm)	X5SB-1848-NSNNL	1	2	\$ 2551.52	\$ 2557.14		
	54”(1372mm)	X5SB-1854-NSNNL	1	2	2691.36	2708.18		
	60”(1524mm)	X5SB-1860-NSNNL	1	2	2831.20	2859.22		
	66”(1676mm)	X5SB-1866-NSNNL	1	2	2971.04	3010.26		
	72”(1829mm)	X5SB-1872-NSNNL	1	2	3110.88	3161.30		
	78”(1981mm)	X5SB-1878-NSNNL	2	3	3250.72	3312.34		
	84”(2134mm)	X5SB-1884-NSNNL	2	3	3390.56	3463.38		
	90”(2286mm)	X5SB-1890-NSNNL	2	3	3530.40	3614.42		
	96”(2438mm)	X5SB-1896-NSNNL	2	3	3670.24	3765.46		
	102”(2591mm)	X5SB-18A2-NSNNL	2	3	3810.08	3916.50		
	108”(2743mm)	X5SB-18A8-NSNNL	2	3	3949.92	4067.54		
Wood Door — No back								
18”(457mm)	48”(1219mm)	X4SB-1848-NSNNW	1	2			\$ 3359.06	\$ 4321.09
	54”(1372mm)	X4SB-1854-NSNNW	1	2			3603.45	4580.17
	60”(1524mm)	X4SB-1860-NSNNW	1	2			3847.84	4839.25
	66”(1676mm)	X4SB-1866-NSNNW	1	2			4092.23	5098.33
	72”(1829mm)	X4SB-1872-NSNNW	1	2			4336.62	5357.41
	78”(1981mm)	X4SB-1878-NSNNW	2	3			4581.01	5616.49
	84”(2134mm)	X4SB-1884-NSNNW	2	3			4825.40	5875.57
	90”(2286mm)	X4SB-1890-NSNNW	2	3			5069.79	6134.65
	96”(2438mm)	X4SB-1896-NSNNW	2	3			5314.18	6393.73
	102”(2591mm)	X4SB-18A2-NSNNW	2	3			5558.57	6652.81
	108”(2743mm)	X4SB-18A8-NSNNW	2	3			5802.96	6911.89
HPL Door — With Finished Back								
18”(457mm)	48”(1219mm)	X5SB-1848-NSLNL	1	2	\$2933.11	\$2938.73		
	54”(1372mm)	X5SB-1854-NSLNL	1	2	3072.95	3089.77		
	60”(1524mm)	X5SB-1860-NSLNL	1	2	3212.79	3240.81		
	66”(1676mm)	X5SB-1866-NSLNL	1	2	3352.63	3391.85		
	72”(1829mm)	X5SB-1872-NSLNL	1	2	3492.47	3542.89		
	78”(1981mm)	X5SB-1878-NSLNL	2	3	3632.31	3693.93		
	84”(2134mm)	X5SB-1884-NSLNL	2	3	3772.15	3844.97		
	90”(2286mm)	X5SB-1890-NSLNL	2	3	3911.99	3996.01		
	96”(2438mm)	X5SB-1896-NSLNL	2	3	4051.83	4147.05		
	102”(2591mm)	X5SB-18A2-NSLNL	2	3	4191.67	4298.09		
	108”(2743mm)	X5SB-18A8-NSLNL	2	3	4331.51	4449.13		
Wood Door — With Finished back								
18”(457mm)	48”(1219mm)	X4SB-1848-NSWNNW	1	2			\$3993.59	\$4955.62
	54”(1372mm)	X4SB-1854-NSWNNW	1	2			4237.98	5214.70
	60”(1524mm)	X4SB-1860-NSWNNW	1	2			4482.37	5473.78
	66”(1676mm)	X4SB-1866-NSWNNW	1	2			4726.76	5732.86
	72”(1829mm)	X4SB-1872-NSWNNW	1	2			4971.15	5991.94
	78”(1981mm)	X4SB-1878-NSWNNW	2	3			5215.54	6251.02
	84”(2134mm)	X4SB-1884-NSWNNW	2	3			5459.93	6510.10
	90”(2286mm)	X4SB-1890-NSWNNW	2	3			5704.32	6769.18
	96”(2438mm)	X4SB-1896-NSWNNW	2	3			5948.71	7028.26
	102”(2591mm)	X4SB-18A2-NSWNNW	2	3			6193.10	7287.34
	108”(2743mm)	X4SB-18A8-NSWNNW	2	3			6437.49	7546.42

Storage Unit

2H Attached Sliding Door – 18” Depth

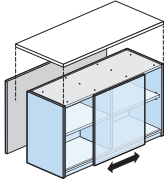

48"-72" widths
X6SA-1848
X4SA-1848

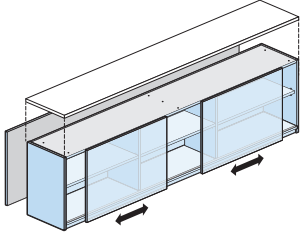

78"-108" widths
X6SA-1848
X4SA-1848
Class RA

Features

- Includes case with optional back panel, non-locking sliding door(s) and adjustable shelf.

Specification Tips

- May be used as a stand alone unit.
- May be used adjacent to applicable attached lower storage or modular components to design a credenza storage unit.
- Not for use with a Convergent Worktop.
- Requires a separately specified Credenza Top.
- The optional finished back panel is .75"(19mm) thick and will increase the overall depth of the attached storage unit.

To Order, Specify:

No Back

- 1) Product number.
- 2) Laminate surface color or wood finish for case and door.
- 3) Edge trim color (laminated only).

With Finished Back

- 1) Product number.
- 2) Laminate surface color or wood finish for case, back and door.
- 3) Edge trim color (laminated only).

Storage Unit

2H Attached Sliding Door – 18” Depth

Depth	Width	Number	Number of Door(s) and Divider(s)	Shelf(s)	HPL A	B	Wood A	B
HPL Door — No back								
18”(457mm)	48”(1219mm)	X5SA-1848-NSNNL	1	2	\$ 2625.70	\$ 2631.81		
	54”(1372mm)	X5SA-1854-NSNNL	1	2	2777.43	2795.68		
	60”(1524mm)	X5SA-1860-NSNNL	1	2	2929.16	2959.55		
	66”(1676mm)	X5SA-1866-NSNNL	1	2	3080.89	3123.42		
	72”(1829mm)	X5SA-1872-NSNNL	1	2	3232.62	3287.29		
	78”(1981mm)	X5SA-1878-NSNNL	2	3	3384.35	3451.16		
	84”(2134mm)	X5SA-1884-NSNNL	2	3	3536.08	3615.03		
	90”(2286mm)	X5SA-1890-NSNNL	2	3	3687.81	3778.90		
	96”(2438mm)	X5SA-1896-NSNNL	2	3	3839.54	3942.77		
	102”(2591mm)	X5SA-18A2-NSNNL	2	3	3991.27	4106.64		
	108”(2743mm)	X5SA-18A8-NSNNL	2	3	4143.00	4270.51		
Wood Door — No back								
18”(457mm)	48”(1219mm)	X4SA-1848-NSNNW	1	2		\$ 3512.49	\$ 4514.81	
	54”(1372mm)	X4SA-1854-NSNNW	1	2		3777.66	4795.90	
	60”(1524mm)	X4SA-1860-NSNNW	1	2		4042.83	5076.99	
	66”(1676mm)	X4SA-1866-NSNNW	1	2		4308.00	5358.08	
	72”(1829mm)	X4SA-1872-NSNNW	1	2		4573.17	5639.17	
	78”(1981mm)	X4SA-1878-NSNNW	2	3		4838.34	5920.26	
	84”(2134mm)	X4SA-1884-NSNNW	2	3		5103.51	6201.35	
	90”(2286mm)	X4SA-1890-NSNNW	2	3		5368.68	6482.44	
	96”(2438mm)	X4SA-1896-NSNNW	2	3		5633.85	6763.53	
	102”(2591mm)	X4SA-18A2-NSNNW	2	3		5899.02	7044.62	
	108”(2743mm)	X4SA-18A8-NSNNW	2	3		6164.19	7325.71	
HPL Door — With Finished Back								
18”(457mm)	48”(1219mm)	X5SA-1848-NSLNL	1	2	\$3039.72	\$3045.83		
	54”(1372mm)	X5SA-1854-NSLNL	1	2	3191.45	3209.70		
	60”(1524mm)	X5SA-1860-NSLNL	1	2	3343.18	3373.57		
	66”(1676mm)	X5SA-1866-NSLNL	1	2	3494.91	3537.44		
	72”(1829mm)	X5SA-1872-NSLNL	1	2	3646.64	3701.31		
	78”(1981mm)	X5SA-1878-NSLNL	2	3	3798.37	3865.18		
	84”(2134mm)	X5SA-1884-NSLNL	2	3	3950.10	4029.05		
	90”(2286mm)	X5SA-1890-NSLNL	2	3	4101.83	4192.92		
	96”(2438mm)	X5SA-1896-NSLNL	2	3	4253.56	4356.79		
	102”(2591mm)	X5SA-18A2-NSLNL	2	3	4405.29	4520.66		
	108”(2743mm)	X5SA-18A8-NSLNL	2	3	4557.02	4684.53		
Wood Door — With Finished back								
18”(457mm)	48”(1219mm)	X4SA-1848-NSWNNW	1	2		\$ 4215.10	\$ 5217.42	
	54”(1372mm)	X4SA-1854-NSWNNW	1	2		4480.27	5498.51	
	60”(1524mm)	X4SA-1860-NSWNNW	1	2		4745.44	5779.60	
	66”(1676mm)	X4SA-1866-NSWNNW	1	2		5010.61	6060.69	
	72”(1829mm)	X4SA-1872-NSWNNW	1	2		5275.78	6341.78	
	78”(1981mm)	X4SA-1878-NSWNNW	2	3		5540.95	6622.87	
	84”(2134mm)	X4SA-1884-NSWNNW	2	3		5806.12	6903.96	
	90”(2286mm)	X4SA-1890-NSWNNW	2	3		6071.29	7185.05	
	96”(2438mm)	X4SA-1896-NSWNNW	2	3		6336.46	7466.14	
	102”(2591mm)	X4SA-18A2-NSWNNW	2	3		6601.63	7747.23	
	108”(2743mm)	X4SA-18A8-NSWNNW	2	3		6866.80	8028.32	

Storage Unit

1.5H Attached Sliding Door – 23” Depth

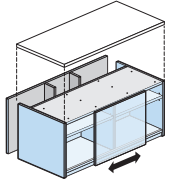

48”-72” widths

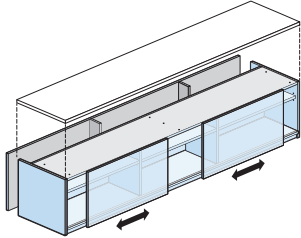

78”-108” widths
X5CB-2348
X4CB-2348
Class RA

Features

- Includes case with optional finished back panel, non-locking sliding door, 5”(127mm)D full height wire way and adjustable shelf.

Specification Tips

- May be used as a stand alone unit or may be used adjacent to 1.5H attached lower storage units.
- Back of storage unit has a 5”(127mm)D full height open wireway intended to conceal a height adjustable T-Leg included with a Height Adjustable Convergent Worktop.
- May be used to support a Convergent Worktop - For use with 1.5H Storage (fixed height convergent worktop with stanchion).
- Requires a separately specified Credenza Top.
- The optional finished back panel is .75”(19mm) thick and will increase the overall depth of the attached storage unit.

To Order, Specify:

No Back

- 1) Product number.
- 2) Laminate surface color or wood finish for case and door.
- 3) Edge trim color (laminated only).

With Finished Back

- 1) Product number.
- 2) Laminate surface color or wood finish for case, back and door.
- 3) Edge trim color (laminated only).

Storage Unit

1.5H Attached Sliding Door – 23” Depth

Depth	Width	Number	Number of Door(s) and Divider(s)	Shelf(s)	HPL A	B	Wood A	B
HPL Door — No back								
23”(584mm)	48”(1219mm)	X5CB-2348-NSNNL	1	2	\$2686.52	\$2702.94		
	54”(1372mm)	X5CB-2354-NSNNL	1	2	2826.36	2853.98		
	60”(1524mm)	X5CB-2360-NSNNL	1	2	2966.20	3005.02		
	66”(1676mm)	X5CB-2366-NSNNL	1	2	3106.04	3156.06		
	72”(1829mm)	X5CB-2372-NSNNL	1	2	3245.88	3307.10		
	78”(1981mm)	X5CB-2378-NSNNL	2	3	3385.72	3458.14		
	84”(2134mm)	X5CB-2384-NSNNL	2	3	3525.56	3609.18		
	90”(2286mm)	X5CB-2390-NSNNL	2	3	3665.40	3760.22		
	96”(2438mm)	X5CB-2396-NSNNL	2	3	3805.24	3911.26		
	102”(2591mm)	X5CB-23A2-NSNNL	2	3	3945.08	4062.30		
	108”(2743mm)	X5CB-23A8-NSNNL	2	3	4084.92	4213.34		
Wood Door — No back								
23”(584mm)	48”(1219mm)	X4CB-2348-NSNNW	1	2			\$ 3915.06	\$ 4910.39
	54”(1372mm)	X4CB-2354-NSNNW	1	2			4159.45	5169.47
	60”(1524mm)	X4CB-2360-NSNNW	1	2			4403.84	5428.55
	66”(1676mm)	X4CB-2366-NSNNW	1	2			4648.23	5687.63
	72”(1829mm)	X4CB-2372-NSNNW	1	2			4892.62	5946.71
	78”(1981mm)	X4CB-2378-NSNNW	2	3			5137.01	6205.79
	84”(2134mm)	X4CB-2384-NSNNW	2	3			5381.40	6464.87
	90”(2286mm)	X4CB-2390-NSNNW	2	3			5625.79	6723.95
	96”(2438mm)	X4CB-2396-NSNNW	2	3			5870.18	6983.03
	102”(2591mm)	X4CB-23A2-NSNNW	2	3			6114.57	7242.11
	108”(2743mm)	X4CB-23A8-NSNNW	2	3			6358.96	7501.19
HPL Door — With Finished Back								
23”(584mm)	48”(1219mm)	X5CB-2348-NSLNL	1	2	\$3068.11	\$3084.53		
	54”(1372mm)	X5CB-2354-NSLNL	1	2	3207.95	3235.57		
	60”(1524mm)	X5CB-2360-NSLNL	1	2	3347.79	3386.61		
	66”(1676mm)	X5CB-2366-NSLNL	1	2	3487.63	3537.65		
	72”(1829mm)	X5CB-2372-NSLNL	1	2	3627.47	3688.69		
	78”(1981mm)	X5CB-2378-NSLNL	2	3	3767.31	3839.73		
	84”(2134mm)	X5CB-2384-NSLNL	2	3	3907.15	3990.77		
	90”(2286mm)	X5CB-2390-NSLNL	2	3	4046.99	4141.81		
	96”(2438mm)	X5CB-2396-NSLNL	2	3	4186.83	4292.85		
	102”(2591mm)	X5CB-23A2-NSLNL	2	3	4326.67	4443.89		
	108”(2743mm)	X5CB-23A8-NSLNL	2	3	4466.51	4594.93		
Wood Door — With Finished back								
23”(584mm)	48”(1219mm)	X4CB-2348-NSWNN	1	2			\$4549.59	\$5544.92
	54”(1372mm)	X4CB-2354-NSWNN	1	2			4793.98	5804.00
	60”(1524mm)	X4CB-2360-NSWNN	1	2			5038.37	6063.08
	66”(1676mm)	X4CB-2366-NSWNN	1	2			5282.76	6322.16
	72”(1829mm)	X4CB-2372-NSWNN	1	2			5527.15	6581.24
	78”(1981mm)	X4CB-2378-NSWNN	2	3			5771.54	6840.32
	84”(2134mm)	X4CB-2384-NSWNN	2	3			6015.93	7099.40
	90”(2286mm)	X4CB-2390-NSWNN	2	3			6260.32	7358.48
	96”(2438mm)	X4CB-2396-NSWNN	2	3			6504.71	7617.56
	102”(2591mm)	X4CB-23A2-NSWNN	2	3			6749.10	7876.64
	108”(2743mm)	X4CB-23A8-NSWNN	2	3			6993.49	8135.72

Storage Unit

2H Attached Sliding Door – 23” Depth

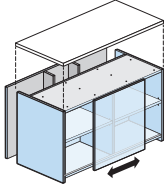

48”-72” widths

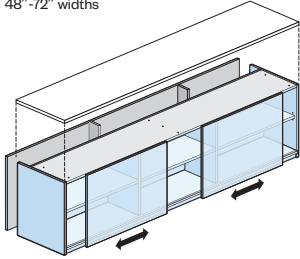

78”-108” widths
X5CA-2348
X4CA-2348
Class RA

Features

- Includes case with optional finished back panel, non-locking sliding door, 5”(127mm)D full height wire way and adjustable shelf.

Specification Tips

- May be used as a stand alone unit.
- May be used adjacent to applicable attached lower storage or modular components to design a credenza storage unit.
- Not for use with a Convergent Worktop.
- Requires a separately specified Credenza Top
- The optional finished back panel is .75”(19mm) thick and will increase the overall depth of the attached storage unit.

To Order, Specify:

No Back

- 1) Product number.
- 2) Laminate surface color or wood finish for case and door.
- 3) Edge trim color (laminate only).

With Finished Back

- 1) Product number.
- 2) Laminate surface color or wood finish for case, back and door.
- 3) Edge trim color (laminate only).

Storage Unit

2H Attached Sliding Door – 23” Depth

Depth	Width	Number	Number of Door(s) and Divider(s)	Shelf(s)	HPL A	B	Wood A	B
HPL Door — No back								
23”(584mm)	48”(1219mm)	X5CA-2348-NSNNL	1	2	\$ 2875.70	\$ 2901.91		
	54”(1372mm)	X5CA-2354-NSNNL	1	2	3027.43	3065.78		
	60”(1524mm)	X5CA-2360-NSNNL	1	2	3179.16	3229.65		
	66”(1676mm)	X5CA-2366-NSNNL	1	2	3330.89	3393.52		
	72”(1829mm)	X5CA-2372-NSNNL	1	2	3482.62	3557.39		
	78”(1981mm)	X5CA-2378-NSNNL	2	3	3634.35	3721.26		
	84”(2134mm)	X5CA-2384-NSNNL	2	3	3786.08	3885.13		
	90”(2286mm)	X5CA-2390-NSNNL	2	3	3937.81	4049.00		
	96”(2438mm)	X5CA-2396-NSNNL	2	3	4089.54	4212.87		
	102”(2591mm)	X5CA-23A2-NSNNL	2	3	4241.27	4376.74		
	108”(2743mm)	X5CA-23A8-NSNNL	2	3	4393.00	4540.61		
Wood Door — No back								
23”(584mm)	48”(1219mm)	X4CA-2348-NSNNW	1	2			\$ 4224.19	\$ 5269.16
	54”(1372mm)	X4CA-2354-NSNNW	1	2			4489.36	5550.25
	60”(1524mm)	X4CA-2360-NSNNW	1	2			4754.53	5831.34
	66”(1676mm)	X4CA-2366-NSNNW	1	2			5019.70	6112.43
	72”(1829mm)	X4CA-2372-NSNNW	1	2			5284.87	6393.52
	78”(1981mm)	X4CA-2378-NSNNW	2	3			5550.04	6674.61
	84”(2134mm)	X4CA-2384-NSNNW	2	3			5815.21	6955.70
	90”(2286mm)	X4CA-2390-NSNNW	2	3			6080.38	7236.79
	96”(2438mm)	X4CA-2396-NSNNW	2	3			6345.55	7517.88
	102”(2591mm)	X4CA-23A2-NSNNW	2	3			6610.72	7798.97
	108”(2743mm)	X4CA-23A8-NSNNW	2	3			6875.89	8080.06
HPL Door — With Finished Back								
23”(584mm)	48”(1219mm)	X5CA-2348-NSLNL	1	2	\$ 3289.72	\$ 3315.93		
	54”(1372mm)	X5CA-2354-NSLNL	1	2	3441.45	3479.80		
	60”(1524mm)	X5CA-2360-NSLNL	1	2	3593.18	3643.67		
	66”(1676mm)	X5CA-2366-NSLNL	1	2	3744.91	3807.54		
	72”(1829mm)	X5CA-2372-NSLNL	1	2	3896.64	3971.41		
	78”(1981mm)	X5CA-2378-NSLNL	2	3	4048.37	4135.28		
	84”(2134mm)	X5CA-2384-NSLNL	2	3	4200.10	4299.15		
	90”(2286mm)	X5CA-2390-NSLNL	2	3	4351.83	4463.02		
	96”(2438mm)	X5CA-2396-NSLNL	2	3	4503.56	4626.89		
	102”(2591mm)	X5CA-23A2-NSLNL	2	3	4655.29	4790.76		
	108”(2743mm)	X5CA-23A8-NSLNL	2	3	4807.02	4954.63		
Wood Door — With Finished back								
23”(584mm)	48”(1219mm)	X4CA-2348-NSWNN	1	2			\$ 4926.80	\$ 5971.77
	54”(1372mm)	X4CA-2354-NSWNN	1	2			5191.97	6252.86
	60”(1524mm)	X4CA-2360-NSWNN	1	2			5457.14	6533.95
	66”(1676mm)	X4CA-2366-NSWNN	1	2			5722.31	6815.04
	72”(1829mm)	X4CA-2372-NSWNN	1	2			5987.48	7096.13
	78”(1981mm)	X4CA-2378-NSWNN	2	3			6252.65	7377.22
	84”(2134mm)	X4CA-2384-NSWNN	2	3			6517.82	7658.31
	90”(2286mm)	X4CA-2390-NSWNN	2	3			6782.99	7939.40
	96”(2438mm)	X4CA-2396-NSWNN	2	3			7048.16	8220.49
	102”(2591mm)	X4CA-23A2-NSWNN	2	3			7313.33	8501.58
	108”(2743mm)	X4CA-23A8-NSWNN	2	3			7578.50	8782.67

Storage Unit

3H Freestanding Open

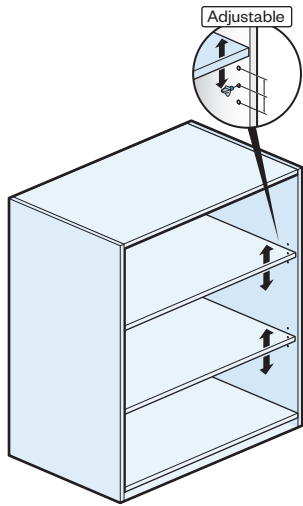

X4N3-NN
X5N3-NN
Class RA

Features

- Includes case, two adjustable shelves; inset unfinished back and glides.
- Adjustable .75"(19mm) thick shelf has ±1.25"(32mm) adjustment range.
- Glides provide 2"(51mm) adjustment range.
- Shipped assembled.

Specification Tips

- Not for use with stack-on storage unit.
- Common storage top is recommended when units are used back to back, or modular credenza top when units are aligned side to side.

To Order, Specify:

1) Product number, including:

1 **Toe Kick Option:**

N No Toe Kick

Y Toe Kick (add **\$198.00** list)

2) Finish code (laminate or wood).

3) Laminate edge trim color (if laminate specified).

Height	Depth	Width	Number	HPL		Wood		
				A	B	A	B	
HPL								
41.625"(1057mm)	19"(483mm)	30"(762mm)	X5N3-1930-NSSNN	\$2005.41	\$2209.55			
		36"(914mm)	X5N3-1936-NSSNN	2075.07	2279.21			
	24"(610mm)	30"(762mm)	X5N3-2430-NSSNN	\$ 2610.92	\$ 2815.06			
		36"(914mm)	X5N3-2436-NSSNN	2680.58	2884.72			
Wood								
41.625"(1057mm)	19"(483mm)	30"(762mm)	X4N3-1930-NSSNN			\$ 2931.25	\$ 3265.72	
		36"(914mm)	X4N3-1936-NSSNN			3000.91	3335.38	
	24"(610mm)	30"(762mm)	X4N3-2430-NSSNN			\$ 3536.76	\$ 3871.23	
		36"(914mm)	X4N3-2436-NSSNN			3606.42	3940.89	

Storage Unit

3H Freestanding with Hinged Doors

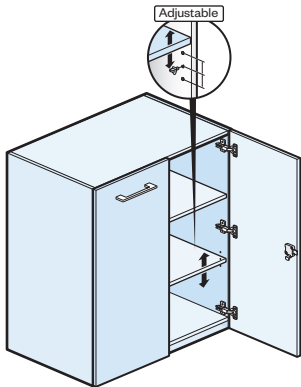

X4H3-LW
X5H3-LL
Class RA

Features

- Includes case, doors with concealed hinges, one adjustable shelf and one fixed shelf; inset unfinished back and glides.
- Adjustable .75"(19mm) thick shelf has ±1.25"(32mm) adjustment range.
- Drawer pull options:
 - Bar pulls available in powdercoat finishes, indicates a door equipped with a touch latch.
 - Wing pulls available in powdercoat finishes.
 - Linear pulls are available in both powdercoat and satin nickel. Satin nickel will need to be specified.
 - Classic pulls are available in brushed nickel finish only. Finish code not required.
 - Touch latch option indicates a door equipped with a touch latch.
- Optional lock available; lock plug available in black or chrome.
- For lock options, refer to Lock Program section of the Accessories Price List.
- Glides provide 2"(51mm) adjustment range.
- Shipped assembled.

Specification Tips

- Not for use with stack-on storage unit.
- Wood units are not designed for applications where the back of unit is visible.

To Order, Specify:

- Product number, including:
 - Door Pull Option*:**
 - F** Touch latch (add **\$160.00** list)
 - B** Bar (add **\$85.00** list)
 - 8** Linear
 - 9** Classic (add **\$30.00** list)
 - W** Wing (add **\$160.00** list)
 - Lock Option:**
 - N** No Lock
 - L** Lock (add **\$177.50** list)
 - Toe Kick Option:**
 - N** No Toe Kick
 - Y** Toe Kick (add **\$198.00** list)
- Finish code (laminate or wood).
- Laminate edge trim color (if laminate specified).
- Trim color for painted pull (if specified).
- Trim color for lock (if specified).

*Price per pull.

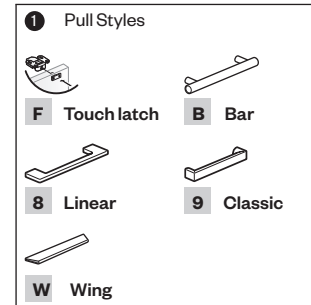

Height	Depth	Width	Number ① ② ③	HPL		Wood	
				A	B	A	B
HPL							
41.625"(1057mm)	19"(483mm)	30"(762mm)	X5H3-1930- SS L	\$ 2337.46	\$ 2485.15		
		36"(914mm)	X5H3-1936- SS L	2378.94	2526.63		
	24"(610mm)	30"(762mm)	X5H3-2430- SS L	\$2934.67	\$3082.36		
		36"(914mm)	X5H3-2436- SS L	2976.15	3123.84		
Wood							
41.625"(1057mm)	19"(483mm)	30"(762mm)	X4H3-1930- SS W			\$3453.75	\$ 3851.51
		36"(914mm)	X4H3-1936- SS W			3503.23	3913.85
	24"(610mm)	30"(762mm)	X4H3-2430- SS W			\$4073.00	\$4484.40
		36"(914mm)	X4H3-2436- SS W			4122.48	4546.74

Lateral File

3H and 4H Freestanding

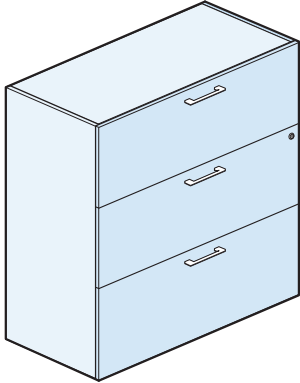

3H
X4F3-LW
X6F3-LL

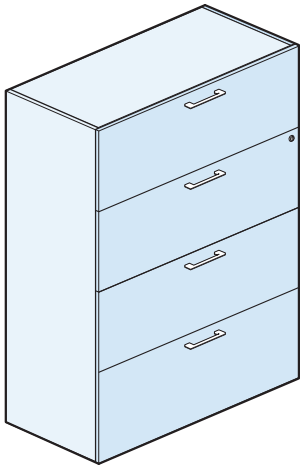

4H
X4F4-LW
X6F4-LL
Class RA

Features

- Includes finished inset top and case and three or four lateral file drawers; inset unfinished back and glides.
- File drawer with an integrated file hanging system.
- Two file hanging bars included per file drawer.
- File drawers have full extension slides with integrated anti-tip interlock feature.
- Drawer pull options:
 - Bar pulls available in powdercoat finishes.
 - Wing pulls available in powdercoat finishes.
 - Linear pulls are available in both powdercoat and satin nickel. Satin nickel will need to be specified.
 - Classic pulls are available in brushed nickel finish only. Finish code not required.
 - Finger pull option available with Walnut double cut and Wood Group B finishes.
- One lock standard per lateral file; includes dual lock bar system.
- Lock plug is available in black or chrome.
- For lock options, refer to Lock Program section of the Accessories Price List.
- Glides provide 2"(51mm) adjustment range.
- Shipped assembled.

Specification Tips

- Not for use with stack-on storage unit.
- 3H lateral file includes field installed counterweight.
- 4H lateral file does not require counterweight.
- Common storage top recommended when units are used back to back.
- Side to side filing bar specified separately.

To Order, Specify:

1) Product number, including:

1 File Drawer Option:

- S** Black Miterfold
- W** Wood
 - 3H (add **\$271.73** list)
 - 4H (add **\$361.67** list)

2 Drawer Pull Option*:

- F** Finger pull (wood only) (add **\$160.00** list)
- B** Bar (add **\$85.00** list)
- 8** Linear
- 9** Classic (add **\$30.00** list)
- Q** Blade (add **\$120.00** list)
- W** Wing (add **\$160.00** list)

3 Toe Kick Option:

- N** No Toe Kick
- Y** Toe Kick (add **\$198.00** list)

2) Finish code (laminate or wood).

3) Laminate edge trim color (if laminate specified).

4) Trim color for painted pull (if specified).

5) Trim color for lock (required).

*Price per pull.

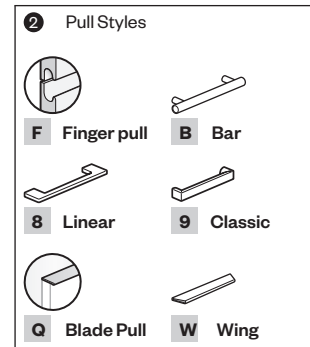

Lateral File

3H and 4H Freestanding

Height	Depth	Width	Number ① ② ③	HPL		Wood		
				A	B	A	B	
HPL — 3H								
41.625"(1057mm)	19"(483mm)	30"(762mm)	X5F3-1930-N	SSBLL	\$3029.08	\$3385.26		
		36"(914mm)	X5F3-1936-N	SSBLL	3232.10	3588.28		
	24"(610mm)	30"(762mm)	X5F3-2430-N	SSBLL	3151.89	3508.07		
		36"(914mm)	X5F3-2436-N	SSBLL	3354.91	3711.09		
HPL — 4H								
55.3125"(1405mm)	19"(483mm)	30"(762mm)	X5F4-1930-N	SSBLL	\$ 3681.21	\$4089.57		
		36"(914mm)	X5F4-1936-N	SSBLL	3884.23	4292.59		
	24"(610mm)	30"(762mm)	X5F4-2430-N	SSBLL	3804.02	4212.38		
		36"(914mm)	X5F4-2436-N	SSBLL	4007.04	4415.40		
Wood — 3H								
41.625"(1057mm)	19"(483mm)	30"(762mm)	X4F3-1930-N	SSBLW			\$ 4749.68	\$ 5251.79
		36"(914mm)	X4F3-1936-N	SSBLW			5011.37	5543.60
	24"(610mm)	30"(762mm)	X4F3-2430-N	SSBLW			4872.49	5389.25
		36"(914mm)	X4F3-2436-N	SSBLW			5134.18	5681.06
Wood — 4H								
55.3125"(1405mm)	19"(483mm)	30"(762mm)	X4F4-1930-N	SSBLW			\$5862.03	\$ 6475.35
		36"(914mm)	X4F4-1936-N	SSBLW			6123.72	6767.16
	24"(610mm)	30"(762mm)	X4F4-2430-N	SSBLW			5984.84	6612.81
		36"(914mm)	X4F4-2436-N	SSBLW			6246.53	6904.62

Lateral File

5H and 6H Freestanding

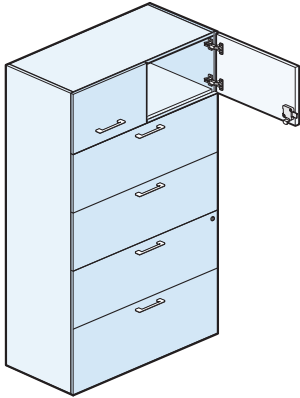

5H
X4F5-LW
X6F5-LL

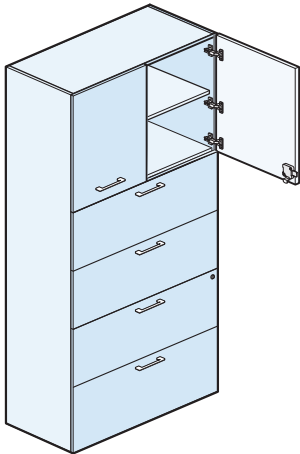

6H
X4F6-LW
X6F6-LL
Class RA

Features

- Includes finished top and case, four lateral file drawers and storage cabinet; inset unfinished back and glides.
- File drawer with an integrated file hanging system.
- Two file hanging bars included per file drawer.
- File drawers have full extension slides with integrated anti-tip interlock feature.
- Drawer pull options:
 - Bar pulls available in powdercoat finished.
 - Blade pulls available in powdercoat finishes, indicates a door equipped with a touch latch.
 - Wing pulls available in powdercoat finishes, indicates a door equipped with a touch latch.
 - Linear pulls are available in both powdercoat and satin nickel. Satin nickel will need to be specified.
 - Classic pulls are available in brushed nickel finish only. Finish code not required.
 - Finger pull option, available with Walnut double cut and Wood Group B finishes, indicates a door equipped with a touch latch.
- One lock standard per lateral file includes dual lock bar system; optional lock available for upper storage cabinet.
- Lock plug is available in black or chrome.
- For lock options, refer to Lock Program section of the Accessories Price List.
- 6H includes one adjustable shelf.
- Adjustable .75" (19mm) thick shelf has ±1.25" (32mm) adjustment range.
- Glides provide 2" (51mm) adjustment range.
- Shipped assembled.

Specification Tips

- Wood units are not designed for applications where the back of unit is visible.
- Side to side filing bar specified separately

To Order, Specify:

1) Product number, including:

1 File Drawer Option:

- S** Black Miterfold
- W** Wood (add **\$361.67** list)

2 Drawer Pull Option*:

- F** Finger pull (wood only) (add **\$160.00** list)
- B** Bar (add **\$85.00** list)
- 8** Linear
- 9** Classic (add **\$30.00** list)
- Q** Blade (add **\$120.00** list)
- W** Wing (add **\$160.00** list)

3 Storage Cabinet Lock Option:

- N** No Lock
- L** Lock (add **\$177.50** list)

4 Toe Kick Option:

- N** No Toe Kick
- Y** Toe Kick (add **\$198.00** list)

2) Finish code (laminate or wood).

3) Laminate edge trim color (if laminate specified).

4) Trim color for painted pull (if specified).

5) Trim color for lock (required).

*Price per pull.

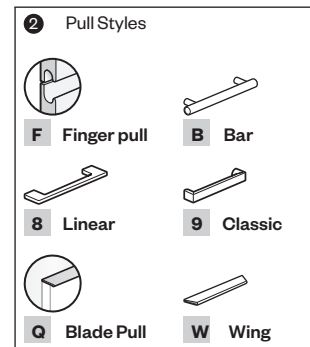

Lateral File

5H and 6H Freestanding

Height	Depth	Width	Number	① ②		③ ④		HPL		Wood	
				A	B	A	B	A	B		
HPL — 5H											
69"(1753mm)	19"(483mm)	30"(762mm)	X5F5-1930-N	SSB	L			\$ 5134.64	\$ 5673.49		
		36"(914mm)	X5F5-1936-N	SSB	L			5337.66	5876.51		
	24"(610mm)	30"(762mm)	X5F5-2430-N	SSB	L			5257.45	5796.30		
		36"(914mm)	X5F5-2436-N	SSB	L			5460.47	5999.32		
HPL — 6H											
81.625"(2073mm)	19"(483mm)	30"(762mm)	X5F6-1930-N	SSB	L			\$ 5551.83	\$ 6124.04		
		36"(914mm)	X5F6-1936-N	SSB	L			5754.85	6327.06		
	24"(610mm)	30"(762mm)	X5F6-2430-N	SSB	L			5674.64	6246.85		
		36"(914mm)	X5F6-2436-N	SSB	L			5877.66	6449.87		
Wood — 5H											
69"(1753mm)	19"(483mm)	30"(762mm)	X4F5-1930-N	SSB	W					\$ 8466.43	\$ 9336.74
		36"(914mm)	X4F5-1936-N	SSB	W					8728.12	9628.55
	24"(610mm)	30"(762mm)	X4F5-2430-N	SSB	W					8589.24	9474.20
		36"(914mm)	X4F5-2436-N	SSB	W					8850.93	9766.01
Wood — 6H											
81.625"(2073mm)	19"(483mm)	30"(762mm)	X4F6-1930-N	SSB	W					\$ 9178.06	\$ 10119.56
		36"(914mm)	X4F6-1936-N	SSB	W					9439.75	10411.37
	24"(610mm)	30"(762mm)	X4F6-2430-N	SSB	W					9300.87	10257.02
		36"(914mm)	X4F6-2436-N	SSB	W					9562.56	10548.83

Lateral File

5H and 6H Combination Unit

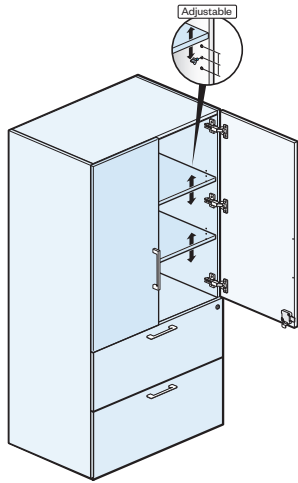

5H
X4M5-LW
X5M5-LL

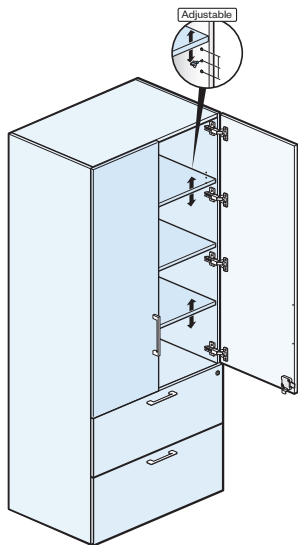

6H
X4M6-LW
X5M6-LL
Class RA

Features

- Includes 2H lateral file drawers, storage cabinet with two adjustable shelves, unfinished back, glides and concealed hinges.
- Adjustable shelf has ±1.25" (32mm) adjustment range.
- File drawer with an integrated file hanging system.
- File drawers have full extension slides with integrated anti-tip interlock feature.
- Two file hanging bars included per file drawer.
- Drawer/door pull options:
 - Bar and Blade pulls available in powdercoat finishes, indicates a door equipped with a touch latch.
 - Wing pulls available in powdercoat finishes.
 - Linear pulls are available in both powdercoat and satin nickel. Satin nickel will need to be specified.
 - Classic pulls are available in brushed nickel finish only. Finish code not required.
 - Finger pull option, available with Walnut double cut and Wood Group B finishes, indicates a door equipped with a touch latch.
- One lock standard per lateral file includes dual lock bar system; Optional lock available for upper storage cabinet.
- Common keys within each storage unit.
- Lock plug is available in black or chrome.
- For lock options, refer to Lock Program section of the Accessories Price List.
- Two adjustable shelves included in 5H. One fixed and two adjustable shelves included in 6H.
- Adjustable shelf has ±1.25" (32mm) adjustment range.
- Glides provide 2" (51mm) adjustment range.
- Lateral file shipped assembled.

Specification Tips

- Wood units are not designed for applications where the back of unit is visible.
- Side to side filing bar specified separately

To Order, Specify:

- 1) Product number, including:
 - 1 File Drawer Option:**
 - S** Black Miterfold
 - W** Wood (add **\$183.60** list)
 - 2 Drawer/Door Pull Option*:**
 - F** Finger pull (wood only) (add **\$160.00** list)
 - B** Bar (add **\$85.00** list)
 - 8** Linear
 - 9** Classic (add **\$30.00** list)
 - Q** Blade (add **\$120.00** list)
 - W** Wing (add **\$160.00** list)
 - 3 Storage Cabinet Lock Option:**
 - N** No Lock
 - L** Lock (add **\$177.50** list)
 - 4 Toe Kick Option:**
 - N** No Toe Kick
 - Y** Toe Kick (add **\$198.00** list)
- 2) Finish code (laminate or wood).
- 3) Laminate edge trim color (if laminate specified).
- 4) Trim color for painted pull (if specified).
- 5) Trim color for lock (required).

*Price per pull.

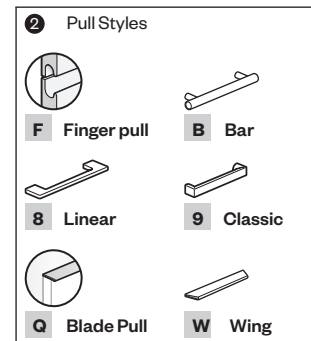

Lateral File

5H and 6H Combination Unit

Height	Depth	Width	Number ① ② ③ ④	HPL		Wood		
				A	B	A	B	
HPL — 5H								
69"(1753mm)	19"(483mm)	30"(762mm)	X5M5-1930-N	SSB	L	\$4203.44	\$4539.78	
		36"(914mm)	X5M5-1936-N	SSB	L	4636.43	4981.49	
	24"(610mm)	30"(762mm)	X5M5-2430-N	SSB	L	4312.92	4649.26	
		36"(914mm)	X5M5-2436-N	SSB	L	4745.91	5090.97	
HPL — 6H								
81.625"(2073mm)	19"(483mm)	30"(762mm)	X5M6-1930-N	SSB	L	\$4473.85	\$4810.19	
		36"(914mm)	X5M6-1936-N	SSB	L	4906.84	5251.90	
	24"(610mm)	30"(762mm)	X5M6-2430-N	SSB	L	4583.33	4919.67	
		36"(914mm)	X5M6-2436-N	SSB	L	5016.32	5361.38	
Wood — 5H								
69"(1753mm)	19"(483mm)	30"(762mm)	X4M5-1930-N	SSB	W		\$6476.65	\$7220.92
		36"(914mm)	X4M5-1936-N	SSB	W		6979.69	7783.14
	24"(610mm)	30"(762mm)	X4M5-2430-N	SSB	W		6586.13	7330.40
		36"(914mm)	X4M5-2436-N	SSB	W		7089.17	7892.62
Wood — 6H								
81.625"(2073mm)	19"(483mm)	30"(762mm)	X4M6-1930-N	SSB	W		\$6791.06	\$7572.34
		36"(914mm)	X4M6-1936-N	SSB	W		7294.10	8134.56
	24"(610mm)	30"(762mm)	X4M6-2430-N	SSB	W		6900.54	7681.82
		36"(914mm)	X4M6-2436-N	SSB	W		7403.58	8244.04

Wardrobe

5H and 6H Open Unit

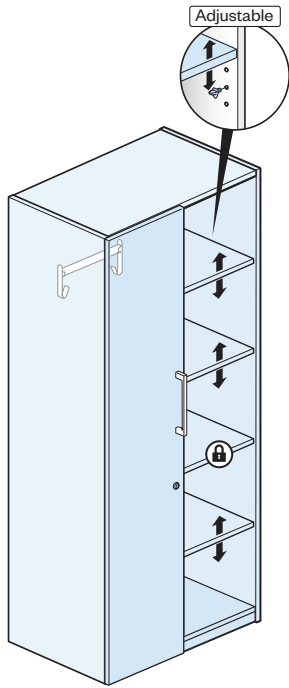

5H
X4W5-WL
X6W5-LL
(Left-hand shown)

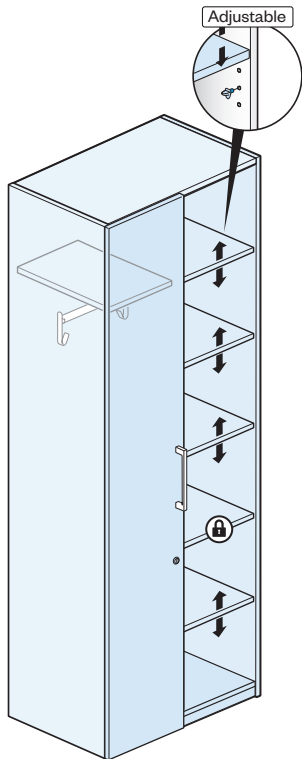

6H
X4W6-WL
X6W6-LL
(Left-hand shown)
Class RA

Features

- Includes open storage with shelves, wardrobe with chrome coat rod with hooks, glides and door complete with concealed hinges.
- Case and door front finished; unfinished back.
- Handed left (L) or right (R) by door hinge orientation.
- 5H includes one fixed shelf and three adjustable shelves.
- 6H includes one fixed shelf and four adjustable shelves.
- Fixed shelf in the second position from the bottom.
- Adjustable shelf has ±1.25" (32mm) adjustment range.
- Door pull options:
 - Bar pulls available in powdercoat finishes, indicates a door equipped with a touch latch.
 - Wing pulls available in powdercoat finishes.
 - Linear pulls are available in both powdercoat and satin nickel. Satin nickel will need to be specified.
 - Classic pulls are available in brushed nickel finish only. Finish code not required.
 - Touch latch option indicates a door equipped with a touch latch.
- Optional lock available; lock plug available in black or chrome.
- For lock options, refer to Lock Program section of the Accessories Price List.
- Glides provide 1" (25mm) adjustment range.
- Shipped assembled.

Specification Tip

- Wood units are not designed for applications where the back of unit is visible.
- Separately specify:
 - Fixed Wardrobe Shelf Accessory
- Includes one set of predrilled holes 15" (381mm)H from interior bottom panel that allow for the Fixed Wardrobe Shelf Accessory.

To Order, Specify:

1) Product number, including:

1 Door Pull Option*:

- F** Touch latch (add **\$160.00** list)
- B** Bar (add **\$85.00** list)
- 8** Linear
- 9** Classic (add **\$30.00** list)
- W** Wing (add **\$160.00** list)

2 Lock Option:

- N** No Lock
- L** Lock (add **\$177.50** list)

3 Wardrobe Orientation:

- L** Left-hand
- R** Right-hand

4 Toe Kick Option:

- N** No Toe Kick
- Y** Toe Kick (add **\$198.00** list)

2) Finish code (laminate or wood).

3) Laminate edge trim color (if laminate specified).

4) Trim color for painted pull (if specified).

5) Trim color for lock (if specified).

*Price per pull.

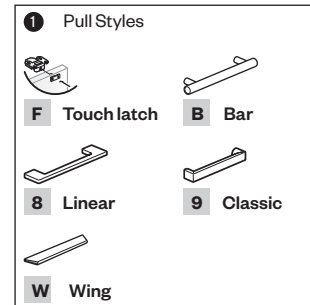

Wardrobe

5H and 6H Open Unit

Height	Depth	Width	Number ① ② ③ ④	HPL		Wood	
				A	B	A	B
HPL — 5H							
69"(1753mm)	19"(483mm)	30"(762mm)	X5W5-1930- SS L	\$ 3139.38	\$3208.31		
		36"(914mm)	X5W5-1936- SS L	3233.94	3302.87		
	24"(610mm)	30"(762mm)	X5W5-2430- SS L	4162.95	4231.88		
		36"(914mm)	X5W5-2436- SS L	4257.51	4326.44		
HPL — 6H							
81.625"(2073mm)	19"(483mm)	30"(762mm)	X5W6-1930- SS L	\$3904.15	\$ 3973.08		
		36"(914mm)	X5W6-1936- SS L	3998.71	4067.64		
	24"(610mm)	30"(762mm)	X5W6-2430- SS L	4927.72	4996.65		
		36"(914mm)	X5W6-2436- SS L	5022.28	5091.21		
Wood — 5H							
69"(1753mm)	19"(483mm)	30"(762mm)	X4W5-1930- SS W			\$ 5147.47	\$ 5723.68
		36"(914mm)	X4W5-1936- SS W			5266.03	5884.30
	24"(610mm)	30"(762mm)	X4W5-2430- SS W			6343.11	7059.96
		36"(914mm)	X4W5-2436- SS W			6461.67	7220.58
Wood — 6H							
81.625"(2073mm)	19"(483mm)	30"(762mm)	X4W6-1930- SS W			\$6032.28	\$ 6722.53
		36"(914mm)	X4W6-1936- SS W			6150.84	6883.15
	24"(610mm)	30"(762mm)	X4W6-2430- SS W			7227.92	8058.81
		36"(914mm)	X4W6-2436- SS W			7346.48	8219.43

Wardrobe

5H and 6H Closed Storage Unit

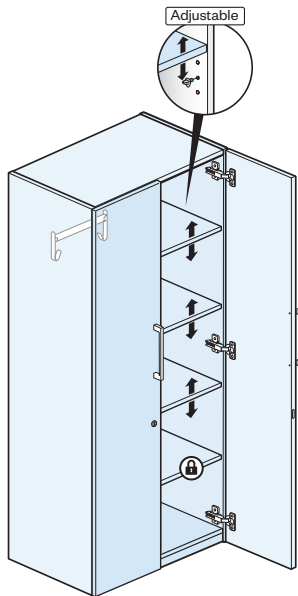

5H
X4X5-LW
X5X5-LL

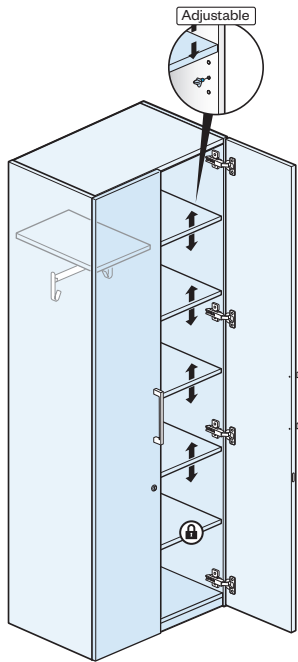

6H
X4X6-LW
X6X6-LL
Class RA

Features

- Includes wardrobe with chrome coat rod with hooks on left side, storage cabinet with shelves on right side, glides and doors with concealed hinges.
- Case and door front finished; unfinished back.
- 5H includes one fixed shelf and three adjustable shelves.
- 6H includes one fixed shelf and four adjustable shelves.
- Fixed shelf in the second position from the bottom.
- Adjustable shelf has ±1.25"(32mm) adjustment range.
- Door pull options:
 - Bar pulls available in powdercoat finishes.
 - Wing pulls available in powdercoat finishes.
 - Linear pulls are available in both powdercoat and satin nickel. Satin nickel will need to be specified.
 - Classic pulls are available in brushed nickel finish only. Finish code not required.
 - Touch latch option, available with Walnut double cut and Wood Group B finishes, indicates a door equipped with a touch latch.
- Optional lock available; lock plug available in black or chrome.
- For lock options, refer to Lock Program section of the Accessories Price List.
- Glides provide 1"(25mm) adjustment range.
- Shipped assembled.

Specification Tip

- Wood units are not designed for applications where the back of unit is visible.
- Separately specify:
 - Fixed Wardrobe Shelf Accessory
- Includes one set of predrilled holes 15"(381mm)H from interior bottom panel that allow for the Fixed Wardrobe Shelf Accessory.

To Order, Specify:

1) Product number, including:

1 Door Pull Option*:

- F** Touch latch (add **\$160.00** list)
- B** Bar (add **\$85.00** list)
- 8** Linear
- 9** Classic (add **\$30.00** list)
- W** Wing (add **\$160.00** list)

2 Lock Option:

- N** No Lock
- L** Lock (add **\$177.50** list)

3 Toe Kick Option:

- N** No Toe Kick
- Y** Toe Kick (add **\$168.00** list)

- 2) Finish code (laminate or wood).
- 3) Laminate edge trim color (if laminate specified).
- 4) Trim color for painted pull (if specified).
- 5) Trim color for lock (if specified).

*Price per pull.

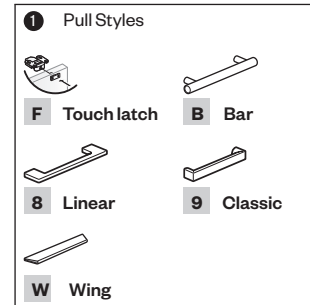

Wardrobe

5H and 6H Closed Storage Unit

Height	Depth	Width	Number ① ② ③	HPL		Wood		
				A	B	A	B	
HPL — 5H								
69"(1753mm)	19"(483mm)	30"(762mm)	X5X5-1930- SS L	\$3562.41	\$ 3631.34			
		36"(914mm)	X5X5-1936- SS L	3656.97	3725.90			
	24"(610mm)	30"(762mm)	X5X5-2430- SS L	4585.98	4654.91			
		36"(914mm)	X5X5-2436- SS L	4680.54	4749.47			
HPL — 6H								
81.625"(2073mm)	19"(483mm)	30"(762mm)	X5X6-1930- SS L	\$ 4327.18	\$4396.11			
		36"(914mm)	X5X6-1936- SS L	4421.74	4490.67			
	24"(610mm)	30"(762mm)	X5X6-2430- SS L	5350.75	5419.68			
		36"(914mm)	X5X6-2436- SS L	5445.31	5514.24			
Wood — 5H								
69"(1753mm)	19"(483mm)	30"(762mm)	X4X5-1930- SS W			\$ 5912.01	\$6488.22	
		36"(914mm)	X4X5-1936- SS W			6030.57	6648.84	
	24"(610mm)	30"(762mm)	X4X5-2430- SS W			7107.65	7824.50	
		36"(914mm)	X4X5-2436- SS W			7226.21	7985.12	
Wood — 6H								
81.625"(2073mm)	19"(483mm)	30"(762mm)	X4X6-1930- SS W			\$ 6796.82	\$ 7487.07	
		36"(914mm)	X4X6-1936- SS W			6915.38	7647.69	
	24"(610mm)	30"(762mm)	X4X6-2430- SS W			7992.46	8823.35	
		36"(914mm)	X4X6-2436- SS W			8111.02	8983.97	

Personal Storage Tower

5H and 6H F/F/F Pedestal and Valet

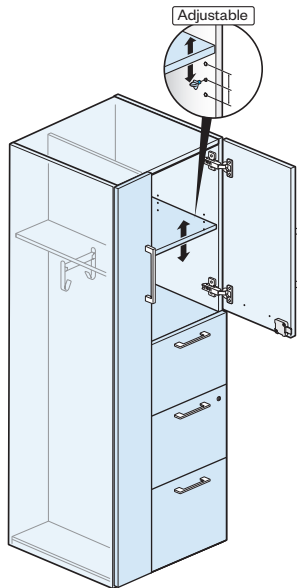

5H

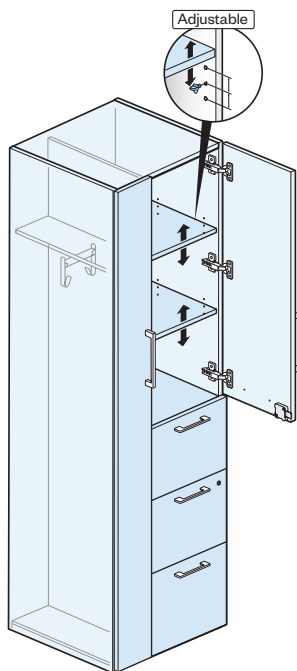

6H
X4AD-WL
X5AD-LL
(Left-hand shown)
Class RA

Features

- Includes three file drawers, closed storage with two adjustable shelves, glides and valet with chrome coat rod with hooks.
- Case and door front finished; unfinished back.
- 5H includes one adjustable shelf in the storage cabinet.
- 6H includes two adjustable shelves in the storage cabinet and a removable hat shelf in the valet.
- Adjustable shelf has ±1.25" (32mm) adjustment range.
- One file hanging bars included per file drawer.
- File drawers have full extension slides.
- Drawer/door pull options:
 - Bar and Blade pulls available in powdercoat finishes.
 - Wing pulls available in powdercoat finishes.
 - Linear pulls are available in both powdercoat and satin nickel. Satin nickel will need to be specified.
 - Classic pulls are available in brushed nickel finish only. Finish code not required.
 - Finger pull option indicates a door equipped with a touch latch.
- Letter width 15.5" (394mm) pedestal.
- One lock standard for file drawers; optional lock available for upper storage cabinet and valet.
- Common keys within each storage unit.
- Lock plug is available in black or chrome.
- For lock options, refer to Lock Program section of the Accessories Price List.
- Glides provide 1" (25mm) adjustment range.
- Shipped assembled.

Specification Tip

- Wood units are not designed for applications where the back of unit is visible.
- Separately specify:
 - Fixed Wardrobe Shelf Accessory
- Includes one set of predrilled holes 15" (381mm)H from interior bottom panel that allow for the Fixed Wardrobe Shelf Accessory.

To Order, Specify:

- 1) Product number, including:
 - 1 Drawer Option:**
 - S** Black Miterfold
 - W** Wood (add **\$236.08** list)
 - 2 Drawer/Door Pull Option*:**
 - F** Finger pull (wood only) (add **\$160.00** list)
 - B** Bar (add **\$85.00** list)
 - 8** Linear
 - 9** Classic (add **\$30.00** list)
 - Q** Blade (add **\$120.00** list)
 - W** Wing (add **\$160.00** list)
 - 3 Storage Cabinet/Valet Lock Option:**
 - N** No Lock
 - L** Lock (add **\$355.00** list)
 - 4 Valet Door Hinge Orientation:**
 - L** Left-hand
 - R** Right-hand
 - 5 Toe Kick Option:**
 - N** No Toe Kick
 - Y** Toe Kick (add **\$180.00** list)
- 2) Finish code (laminated or wood).
- 3) Laminate edge trim color (if laminate specified).
- 4) Trim color for painted pull (if specified).
- 5) Trim color for lock (required).

*Price per pull.

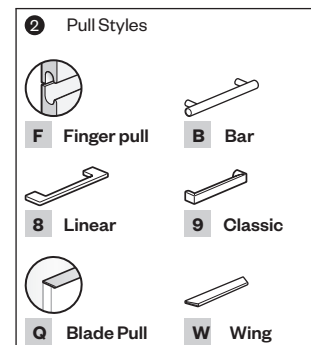

Personal Storage Tower

5H and 6H F/F/F Pedestal and Valet

Height	Depth	Width	Number ① ② ③ ④ ⑤	HPL		Wood		
				A	B	A	B	
HPL — 5H								
69"(1753mm)	24"(610mm)	24"(610mm)	X5AD-6924- ■ ■ ■ SSS ■ L ■ ■ ■	\$4304.80	\$4737.44			
HPL — 6H								
81.625"(2073mm)	24"(610mm)	24"(610mm)	X5AD-8124- ■ ■ ■ SSS ■ L ■ ■ ■	\$5220.54	\$5726.37			
Wood — 5H								
69"(1753mm)	24"(610mm)	24"(610mm)	X4AD-6924- ■ ■ ■ SSS ■ W ■ ■ ■			\$6572.84	\$7328.86	
Wood — 6H								
81.625"(2073mm)	24"(610mm)	24"(610mm)	X4AD-8124- ■ ■ ■ SSS ■ W ■ ■ ■			\$7641.89	\$8530.79	

Personal Storage Tower

5H and 6H F/F Pedestal and Valet

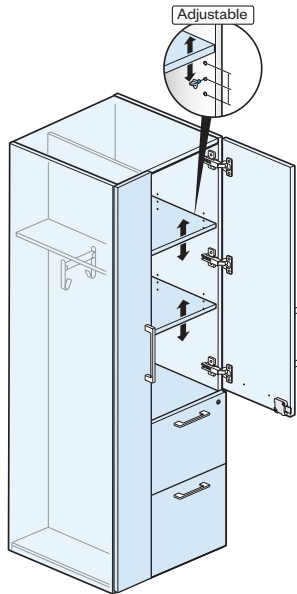

5H

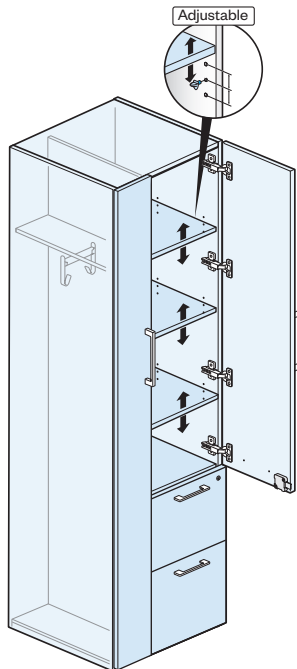

6H
X4AF-WL
X5AF-LL
(Left-hand shown)
Class RA

Features

- Includes two file drawers, closed storage with adjustable shelves, glides and wardrobe with chrome coat rod.
- Case and door front finished; unfinished back.
- Handed left (L) or right (R) based on valet door hinge orientation.
- 5H includes two adjustable shelves in the storage cabinet.
- 6H includes three adjustable shelves in the storage cabinet and one additional shelf in the valet.
- Adjustable shelf has ±1.25"(32mm) adjustment range.
- One file hanging bars included per file drawer.
- File drawers have full extension slides.
- Drawer and door pull options:
 - Bar pulls available in powdercoat finished.
 - Blade pulls available in powdercoat finishes, indicates a door equipped with a touch latch.
 - Wing pulls available in powdercoat finishes.
 - Linear pulls are available in both powdercoat and satin nickel. Satin nickel will need to be specified.
 - Classic pulls are available in brushed nickel finish only. Finish code not required.
 - Finger pull option, available with Walnut double cut and Wood Group B finishes, indicates a door equipped with a touch latch.
- Letter width 15.5"(394mm) pedestals.
- One lock standard for file drawers; optional lock available for upper storage cabinet and valet.
- Common keys within each storage unit.
- Lock plug is available in black or chrome.
- For lock options, refer to Lock Program section of the Accessories Price List.
- Glides provide 1"(25mm) adjustment range.
- Shipped assembled.

Specification Tip

- Wood units are not designed for applications where the back of unit is visible.
- Separately specify:
 - Fixed Wardrobe Shelf Accessory
 - Coat Rod with Hooks
- Includes one set of predrilled holes 15"(381mm)H from interior bottom panel that allow for the Fixed Wardrobe Shelf Accessory.

To Order, Specify:

- 1) Product number, including:
 - 1 Drawer Option:**
 - S** Black Miterfold
 - W** Wood (add **\$236.08** list)
 - 2 Drawer and Door Pull Options*:**
 - F** Finger pull (wood only) (add **\$160.00** list)
 - B** Bar (add **\$85.00** list)
 - 8** Linear
 - 9** Classic (add **\$30.00** list)
 - Q** Blade (add **\$120.00** list)
 - W** Wing (add **\$160.00** list)
 - 3 Storage Cabinet/Valet Lock Option:**
 - N** No Lock
 - L** Lock (add **\$355.00** list)
 - 4 Valet Door Hinge Orientation:**
 - L** Left-hand
 - R** Right-hand
 - 5 Toe Kick Option:**
 - N** No Toe Kick
 - Y** Toe Kick (add **\$180.00** list)
- 2) Finish code (laminated or wood).
- 3) Laminate edge trim color (if laminate specified).
- 4) Trim color for painted pull (if specified).
- 5) Trim color for lock (required).

*Price per pull.

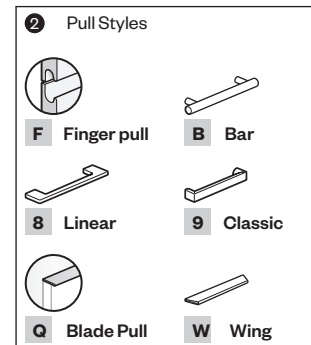

Personal Storage Tower

5H and 6H F/F Pedestal and Valet

Height	Depth	Width	Number ① ② ③ ④ ⑤	HPL		Wood		
				A	B	A	B	
HPL — 5H								
69"(1753mm)	24"(610mm)	24"(610mm)	X5AF-6924- ■ ■ ■ SSS ■ L ■ ■ ■	\$ 3517.74	\$ 3931.32			
HPL — 6H								
81.625"(2073mm)	24"(610mm)	24"(610mm)	X5AF-8124- ■ ■ ■ SSS ■ L ■ ■ ■	\$4406.91	\$4944.91			
Wood — 5H								
69"(1753mm)	24"(610mm)	24"(610mm)	X4AF-6924- ■ ■ ■ SSS ■ W ■ ■ ■			\$5553.02	\$ 6187.50	
Wood — 6H								
81.625"(2073mm)	24"(610mm)	24"(610mm)	X4AF-8124- ■ ■ ■ SSS ■ W ■ ■ ■			\$6442.19	\$7253.47	

Storage Tower

5H and 6H

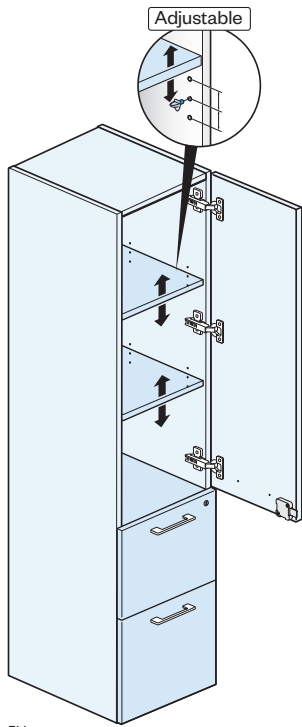

Features

- Includes two file drawers, closed storage with adjustable shelves and glides.
- Case and door front finished; unfinished back.
- Handed left (L) or right (R) based on closed storage door hinge orientation.
- 5H includes two adjustable shelves in the storage cabinet.
- 6H includes three adjustable shelves in the storage cabinet.
- Adjustable shelf has ±1.25" (32mm) adjustment range.
- One file hanging bars included per file drawer.
- File drawers have full extension slides.
- Drawer and door pull options:
 - Bar pulls available in powdercoat finished.
 - Blade pulls available in powdercoat finishes, indicates a door equipped with a touch latch.
 - Wing pulls available in powdercoat finishes.
 - Linear pulls are available in both powdercoat and satin nickel. Satin nickel will need to be specified.
 - Classic pulls are available in brushed nickel finish only. Finish code not required.
 - Finger pull option, available with Walnut double cut and Wood Group B finishes, indicates a door equipped with a touch latch.
- Letter width 15.5" (394mm) pedestals.
- One lock standard for file drawers; optional lock available for upper storage cabinet and valet.
- Common keys within each storage unit.
- Lock plug is available in black or chrome.
- For lock options, refer to Lock Program section of the Accessories Price List.
- Glides provide 1" (25mm) adjustment range.
- Shipped assembled.

Specification Tip

- Wood units are not designed for applications where the back of unit is visible.

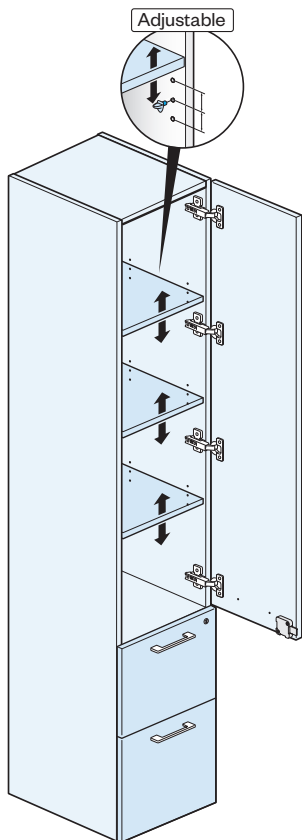

To Order, Specify:

- 1) Product number, including:
 - 1 **Drawer Option:**
 - S Black Miterfold
 - W Wood (add **\$236.08** list)
 - 2 **Drawer and Door Pull Options*:**
 - F Finger pull (wood only) (add **\$160.00** list)
 - B Bar (add **\$85.00** list)
 - 8 Linear
 - 9 Classic (add **\$30.00** list)
 - Q Blade (add **\$120.00** list)
 - W Wing (add **\$160.00** list)
 - 3 **Storage Cabinet Lock Option:**
 - N No Lock
 - L Lock (add **\$177.50** list)
 - 4 **Storage Door Hinge Orientation:**
 - L Left-hand
 - R Right-hand
 - 5 **Toe Kick Option:**
 - N No Toe Kick
 - Y Toe Kick (add **\$168.00** list)
- 2) Finish code (laminate or wood).
- 3) Laminate edge trim color (if laminate specified).
- 4) Trim color for painted pull (if specified).
- 5) Trim color for lock (required).

*Price per pull.

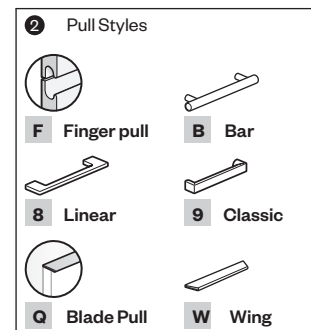

6H
X4ZF-WR
X6ZF-LR
(Right-hand shown)
Class RA

Storage Tower

5H and 6H

Height	Depth	Width	Number ① ② ③ ④ ⑤	HPL		Wood		
				A	B	A	B	
HPL — 5H								
69"(1753mm)	19"(483mm)	15.5"(394mm)	X5ZF-6919- ■ ■ ■ SSS L ■ ■	\$ 3104.67	\$3485.24			
	24"(610mm)		X5ZF-6924- ■ ■ ■ SSS L ■ ■	3262.26	3655.43			
HPL — 6H								
81.625"(2073mm)	19"(483mm)	15.5"(394mm)	X5ZF-8119- ■ ■ ■ SSS L ■ ■	\$ 3771.58	\$4258.85			
	24"(610mm)		X5ZF-8124- ■ ■ ■ SSS L ■ ■	3929.17	4429.04			
Wood — 5H								
69"(1753mm)	19"(483mm)	15.5"(394mm)	X4ZF-6919- ■ ■ ■ SSS W ■ ■			\$ 5139.95	\$5724.59	
	24"(610mm)		X4ZF-6924- ■ ■ ■ SSS W ■ ■			5297.54	5901.19	
Wood — 6H								
81.625"(2073mm)	19"(483mm)	15.5"(394mm)	X4ZF-8119- ■ ■ ■ SSS W ■ ■			\$5806.86	\$6552.30	
	24"(610mm)		X4ZF-8124- ■ ■ ■ SSS W ■ ■			5964.45	6728.90	

Wardrobe

5H and 6H

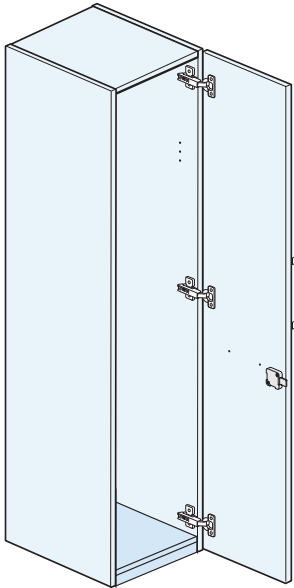

5H
X4Y5-WR
X5Y5-LR

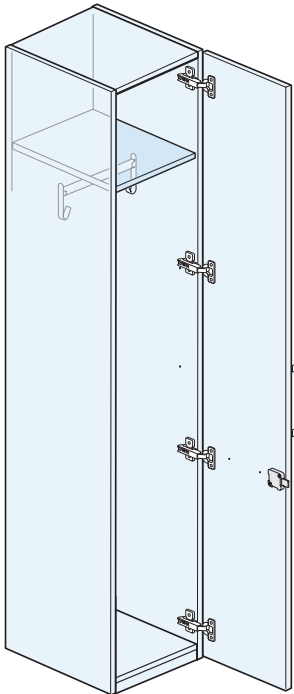

6H
X4Y6-WR
X6Y6-LR
(Right-hand shown)
Class RA

Features

- Includes wardrobe cabinet with chrome coat rod; inset unfinished back and glides.
- Handed left (L) or right (R) by door hinge orientation.
- Case and door front finished; unfinished back.
- Door pull options:
 - Bar pulls available in powdercoat finishes.
 - Wing pulls available in powdercoat finishes.
 - Linear pulls are available in both powdercoat and satin nickel. Satin nickel will need to be specified.
 - Classic pulls are available in brushed nickel finish only. Finish code not required.
 - Touch latch option indicates a door equipped with a touch latch.
- Fixed upper shelf included with 6H unit.
- Optional lock available; lock plug available in black or chrome.
- For lock options, refer to Lock Program section of the Accessories Price List.
- Glides provide 1"(25mm) adjustment range.
- Shipped assembled.

Specification Tips

- Wood units are not designed for applications where the back of unit is visible.
- Separately specify:
 - Fixed Wardrobe Shelf Accessory
- 12"(305mm) wardrobe must be attached to wall.
- Includes one set of predrilled holes 15"(381mm)H from interior bottom panel that allow for the Fixed Wardrobe Shelf Accessory.

To Order, Specify:

1) Product number, including:

1 Door Pull Option*:

- F** Touch latch (add **\$160.00** list)
- B** Bar (add **\$85.00** list)
- 8** Linear
- 9** Classic (add **\$30.00** list)
- W** Wing (add **\$160.00** list)

2 Lock Option:

- N** No Lock
- L** Lock (add **\$177.50** list)

3 Door Hinge Orientation:

- L** Left-hand
- R** Right-hand

4 Toe Kick Option:

- N** No Toe Kick
- Y** Toe Kick (add **\$168.00** list)

2) Finish code (laminate or wood).

3) Laminate edge trim color (if laminate specified).

4) Trim color for painted pull (if specified).

5) Trim color for lock (if specified).

*Price per pull.

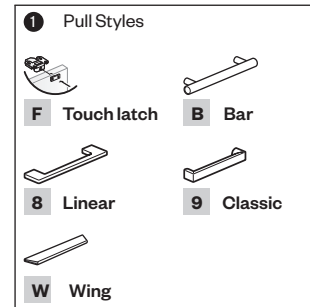

Wardrobe

5H and 6H

Height	Depth	Nominal Width	Actual Width	Number	① ② ③ ④				HPL		Wood	
					A	B	A	B				
HPL — 5H												
69"(1753mm)	19"(483mm)	12"(305mm)	12"(305mm)	X5Y5-1912-	SS	L	■	■	\$ 1161.65	\$ 1230.58		
		16"(406mm)	15.5"(394mm)	X5Y5-1916-	SS	L	■	■	1310.52	1436.89		
		19"(483mm)	18.6"(472mm)	X5Y5-1919-	SS	L	■	■	2981.78	3050.71		
	24"(610mm)	12"(305mm)	12"(305mm)	X5Y5-2412-	SS	L	■	■	1885.22	1954.15		
		16"(406mm)	15.5"(394mm)	X5Y5-2416-	SS	L	■	■	2334.09	2460.46		
		19"(483mm)	18.6"(472mm)	X5Y5-2419-	SS	L	■	■	4005.35	4074.28		
HPL — 6H												
81.625"(2073mm)	19"(483mm)	12"(305mm)	12"(305mm)	X5Y6-1912-	SS	L	■	■	\$ 1926.42	\$ 1995.35		
		16"(406mm)	15.5"(394mm)	X5Y6-1916-	SS	L	■	■	2075.29	2201.66		
		19"(483mm)	18.6"(472mm)	X5Y6-1919-	SS	L	■	■	3746.55	3815.48		
	24"(610mm)	12"(305mm)	12"(305mm)	X5Y6-2412-	SS	L	■	■	2649.99	2718.92		
		16"(406mm)	15.5"(394mm)	X5Y6-2416-	SS	L	■	■	3098.86	3225.23		
		19"(483mm)	18.6"(472mm)	X5Y6-2419-	SS	L	■	■	4770.12	4839.05		
Wood — 5H												
69"(1753mm)	19"(483mm)	12"(305mm)	12"(305mm)	X4Y5-1912-	SS	W	■	■			\$ 3113.74	\$ 3591.81
		16"(406mm)	15.5"(394mm)	X4Y5-1916-	SS	W	■	■			2813.74	3291.81
		19"(483mm)	18.6"(472mm)	X4Y5-1919-	SS	W	■	■			4949.87	5455.98
	24"(610mm)	12"(305mm)	12"(305mm)	X4Y5-2412-	SS	W	■	■			4009.38	4628.09
		16"(406mm)	15.5"(394mm)	X4Y5-2416-	SS	W	■	■			4009.38	4628.09
		19"(483mm)	18.6"(472mm)	X4Y5-2419-	SS	W	■	■			6145.51	6792.26
Wood — 6H												
81.625"(2073mm)	19"(483mm)	12"(305mm)	12"(305mm)	X4Y6-1912-	SS	W	■	■			\$ 3998.55	\$ 4590.66
		16"(406mm)	15.5"(394mm)	X4Y6-1916-	SS	W	■	■			3698.55	4290.66
		19"(483mm)	18.6"(472mm)	X4Y6-1919-	SS	W	■	■			5834.68	6454.83
	24"(610mm)	12"(305mm)	12"(305mm)	X4Y6-2412-	SS	W	■	■			4894.19	5626.94
		16"(406mm)	15.5"(394mm)	X4Y6-2416-	SS	W	■	■			4894.19	5626.94
		19"(483mm)	18.6"(472mm)	X4Y6-2419-	SS	W	■	■			7030.32	7791.11

Wardrobe

Fixed Boot Shelf

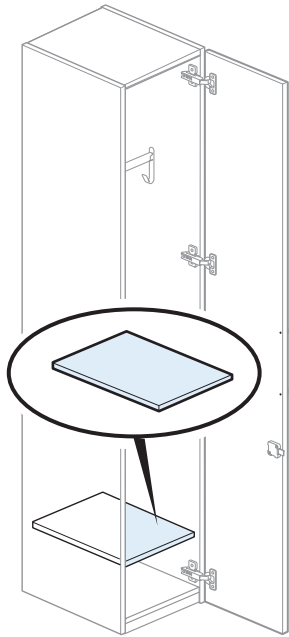

XLAS
XXAS
Class RA

Features

- Includes one fixed shelf and attachment hardware (4 shelf pins).
- Available in both high pressure laminate (HPL) and wood.

Specification Tip

- For use in wardrobe sections of Wardrobes, Personal Storage Towers, and Wardrobe with Open Shelving or Closed Storage unit.

To Order, Specify:

- 1) Product number.
- 2) Finish code (laminate or wood).
- 3) Laminate edge trim color (if laminate, paint or wood specified).

Depth	Width	Number	HPL		Wood	
			A	B	A	B
HPL						
19"(483mm)	12"(305mm)	XLAS-1912-N	\$164.72	\$ 179.68		
	16"(406mm)	XLAS-1916-N	168.39	188.42		
	19"(483mm)	XLAS-1919-N	171.63	196.14		
	30"(762mm)	XLAS-1930-N	168.22	188.03		
	36"(914mm)	XLAS-1936-N	171.35	195.49		
24"(610mm)	8"(203mm)	XLAS-2408-N	164.17	178.37		
	16"(406mm)	XLAS-2416-N	172.64	198.56		
	19"(483mm)	XLAS-2419-N	176.84	208.55		
	30"(762mm)	XLAS-2430-N	172.43	198.05		
	36"(914mm)	XLAS-2436-N	176.49	207.71		
Wood						
19"(483mm)	12"(305mm)	XXAS-1912-N			\$329.64	\$358.82
	16"(406mm)	XXAS-1916-N			334.97	374.05
	19"(483mm)	XXAS-1919-N			339.69	387.51
	30"(762mm)	XXAS-1930-N			334.74	373.37
	36"(914mm)	XXAS-1936-N			339.29	386.37
24"(610mm)	8"(203mm)	XXAS-2408-N			328.84	356.54
	16"(406mm)	XXAS-2416-N			341.17	391.72
	19"(483mm)	XXAS-2419-N			347.27	409.13
	30"(762mm)	XXAS-2430-N			340.86	390.84
	36"(914mm)	XXAS-2436-N			346.76	346.76

Bookcase

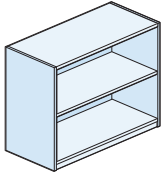

2H
ULB2-S
UXB2-S

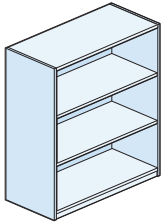

3H
ULB3-S
UXB3-S

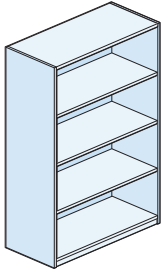

4H
ULB4-S
UXB4-S

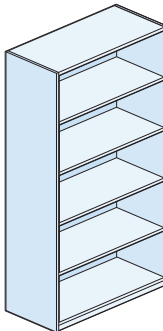

5H
ULB5-S
UXB5-S

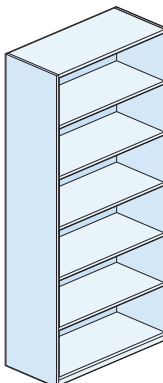

6H
ULB6-S
UXB6-S
Class RA

Features

- Includes bookcase with glides and finished top and shelves; finished inset top, inset unfinished back and inset toe kick.
 - 2H includes one adjustable shelf.
 - 3H includes two adjustable shelves.
 - 4H includes two adjustable shelves and one fixed shelf.
 - 5H includes three adjustable shelves and one fixed shelf.
 - 6H includes four adjustable shelves and one fixed shelf.
- Adjustable .75" (19mm) thick shelf has ±1.25" (32mm) adjustment range.
- .75" (19mm) thick fixed shelf in the second position from the bottom.
- Glides provide 1" (25mm) adjustment range.
- Shipped assembled.

Specification Tip

- Wood units are not designed for applications where the back of unit is visible.

To Order, Specify:

- 1) Product number.
- 2) Finish code (laminated or wood).
- 3) Laminate edge trim color (if laminate, paint or wood specified).

Bookcase

Height	Depth	Width	Number	HPL		Wood	
				A	B	A	B
HPL — Letter Depth — 2H							
28"(711mm)	14"(356mm)	30"(762mm)	ULB2-1430-S	\$ 1040.82	\$ 1124.76		
		36"(914mm)	ULB2-1436-S	1087.28	1171.22		
HPL — Letter Depth — 3H							
41.625"(1057mm)	14"(356mm)	30"(762mm)	ULB3-1430-S	\$ 1073.87	\$ 1157.81		
		36"(914mm)	ULB3-1436-S	1148.53	1232.47		
HPL — Letter Depth — 4H							
55.3125"(1405mm)	14"(356mm)	30"(762mm)	ULB4-1430-S	\$ 1093.98	\$ 1177.92		
		36"(914mm)	ULB4-1436-S	1195.18	1279.12		
HPL — Letter Depth — 5H							
69"(1753mm)	14"(356mm)	30"(762mm)	ULB5-1430-S	\$ 1387.26	\$ 1471.20		
		36"(914mm)	ULB5-1436-S	1515.01	1598.95		
HPL — Letter Depth — 6H							
81.625"(2073mm)	14"(356mm)	30"(762mm)	ULB6-1430-S	\$ 1747.22	\$ 1831.16		
		36"(914mm)	ULB6-1436-S	1903.16	1987.10		
HPL — Legal Depth — 2H							
28"(711mm)	16.5"(419mm)	30"(762mm)	ULB2-1730-S	\$ 1087.28	\$ 1171.22		
		36"(914mm)	ULB2-1736-S	1133.74	1217.68		
HPL — Legal Depth — 3H							
41.625"(1057mm)	16.5"(419mm)	30"(762mm)	ULB3-1730-S	\$ 1148.53	\$1232.47		
		36"(914mm)	ULB3-1736-S	1223.19	1307.13		
HPL — Legal Depth — 4H							
55.3125"(1405mm)	16.5"(419mm)	30"(762mm)	ULB4-1730-S	\$ 1195.18	\$1279.12		
		36"(914mm)	ULB4-1736-S	1296.38	1380.32		
HPL — Legal Depth — 5H							
69"(1753mm)	16.5"(419mm)	30"(762mm)	ULB5-1730-S	\$ 1515.01	\$1598.95		
		36"(914mm)	ULB5-1736-S	1642.76	1726.70		
HPL — Legal Depth — 6H							
81.625"(2073mm)	16.5"(419mm)	30"(762mm)	ULB6-1730-S	\$ 1903.16	\$1987.10		
		36"(914mm)	ULB6-1736-S	2059.10	2143.04		
Wood — Letter Depth — 2H							
28"(711mm)	14"(356mm)	30"(762mm)	UXB2-1430-S			\$2062.34	\$2340.04
		36"(914mm)	UXB2-1436-S			2108.80	2390.73
Wood — Letter Depth — 3H							
41.625"(1057mm)	14"(356mm)	30"(762mm)	UXB3-1430-S			\$ 2587.96	\$ 2865.66
		36"(914mm)	UXB3-1436-S			2662.62	2944.55
Wood — Letter Depth — 4H							
55.3125"(1405mm)	14"(356mm)	30"(762mm)	UXB4-1430-S			\$ 3113.59	\$ 3391.29
		36"(914mm)	UXB4-1436-S			3214.79	3496.72
Wood — Letter Depth — 5H							
69"(1753mm)	14"(356mm)	30"(762mm)	UXB5-1430-S			\$3634.94	\$ 3912.64
		36"(914mm)	UXB5-1436-S			3762.69	4044.62
Wood — Letter Depth — 6H							
81.625"(2073mm)	14"(356mm)	30"(762mm)	UXB6-1430-S			\$ 4160.55	\$4438.25
		36"(914mm)	UXB6-1436-S			4316.49	4598.42
Wood — Legal Depth — 2H							
28"(711mm)	16.5"(419mm)	30"(762mm)	UXB2-1730-S			\$ 2108.80	\$ 2390.73
		36"(914mm)	UXB2-1736-S			2155.26	2441.42
Wood — Legal Depth — 3H							
41.625"(1057mm)	16.5"(419mm)	30"(762mm)	UXB3-1730-S			\$2662.62	\$ 2944.55
		36"(914mm)	UXB3-1736-S			2737.28	3023.44
Wood — Legal Depth — 4H							
55.3125"(1405mm)	16.5"(419mm)	30"(762mm)	UXB4-1730-S			\$ 3214.79	\$ 3496.72
		36"(914mm)	UXB4-1736-S			3315.99	3602.15
Wood — Legal Depth — 5H							
69"(1753mm)	16.5"(419mm)	30"(762mm)	UXB5-1730-S			\$3762.69	\$4044.62
		36"(914mm)	UXB5-1736-S			3890.44	4176.60
Wood — Legal Depth — 6H							
81.625"(2073mm)	16.5"(419mm)	30"(762mm)	UXB6-1730-S			\$ 4316.49	\$4598.42
		36"(914mm)	UXB6-1736-S			4472.43	4758.59

Table

Round

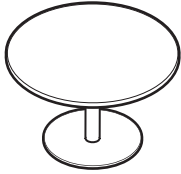

XZAM-IS
Class RA

Features

- Includes round top and 27"(686mm) disc base.
- 30"(762mm) and 36"(914mm) includes 21"(533mm) disc base.
- 42"(1067mm) and 48"(1219mm) includes 27"(686mm) disc base.
- Fixed height base: 29.25"(743mm).
- 1.18"(30mm) thick high-pressure laminate (HPL) worksurface with edgeband.
- 1.18"(30mm) thick Wood worksurface with a choice of profiled edge (Square or Bevel). **Double-cut veneers available with Square 3mm edge only.**

To Order, Specify:

1) Product number, including:

1 Edge Option:

Wood:

1 Square

5 Bevel (add **\$292.55** list)

2) Finish code (laminate or wood).

3) Laminate edge trim color (if laminate specified).

4) Trim code for disc base.

Note: \$24.28 upcharge (list) for metallic or accent trim colors.

Height	Depth	Number ①	HPL		Wood	
			A	B	A	B
HPL						
29.25"(743mm)	30"(762mm)	XLAM-3000-JS	\$ 2128.70	\$ 2219.92		
	36"(914mm)	XLAM-3600-JS	2338.39	2425.54		
	42"(1067mm)	XLAM-4200-JS	2585.10	2667.44		
	48"(1219mm)	XLAM-4800-JS	2868.83	2945.62		
Wood						
29.25"(743mm)	30"(762mm)	XZAM-3000-■S			\$2280.04	\$2432.43
	36"(914mm)	XZAM-3600-■S			2580.82	2750.70
	42"(1067mm)	XZAM-4200-■S			2929.62	3119.79
	48"(1219mm)	XZAM-4800-■S			3326.44	3539.70

Accessories

Counterweight

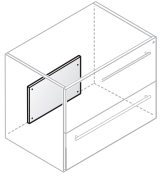

UXWA
Class RA

Features

- Includes counterweight and attachment hardware.
- Standard in painted black steel only

Specification Tips

- Required for use with 1H, 1.5H and 2H attached lateral file with finished back and credenza top in a free-standing application.
- Not required for 4H, 5H or 6H freestanding lateral file cabinets.

To Order, Specify:

- 1) Product number.
(No finish specification required.)

Height	Width	Number	Price
18.75"(476mm)	14"(356mm)	UXWA-1914	\$82.94

Flush Mount Plate

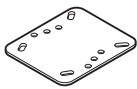

ZUBF-0000-PN
Class CA

Features

- Includes one bracket and mounting screws.
- Mounts straight end of convergent worksurfaces or conference end worksurfaces to panel-hung worksurfaces.
- Standard in charcoal finish color only.
- Provides attachment of two worksurfaces at the same height.

To Order, Specify:

- 1) Product number.
(No finish specification required.)

Depth	Width	Number	Price
3"(76mm)	4"(102mm)	ZUBF-0000-PN	\$35.85

Tetra Bracket

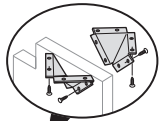

W111-5298
Open Market Item

Features

- Includes bracket and hardware.
- Standard in black steel only.
- Used to connect end panel to work surface.

To Order, Specify:

- 1) Product number.
(No finish specification required.)

Height	Depth	Width	Number	Price
3.25"(83mm)	3.75"(95mm)	6.5"(165mm)	W111-5298	\$47.88

Accessories

Center Drawer

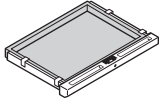

UXCD
Class RA

Features

- Center drawer includes attachment hardware.
- Hardwood front rail with routed pencil channels.
- Drawer body is black miterfold.
- Optional lock available in black or chrome.
- For lock options, refer to Lock Program section of the Accessories Price List.
- Field installation required.

Specification Tips

- For use under worksurface of single pedestal desk, double pedestal desk, convergent D-top, convergent P-top, desk shell, credenza shell and credenzas with pedestals.

To Order, Specify:

- 1) Product number, including:

1 Lock Option:

- N No Lock
- L Lock (add **\$86.97** list)

- 2) Wood finish - Grade B Veneers only available.
- 3) Trim color for lock plug.

Height	Depth	Width	Number ①	Price
1.875"(48mm)	17.5"(445mm)	24"(610mm)	UXCD-1824-■	\$674.53

Pencil Tray

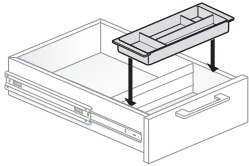

JPTA-6

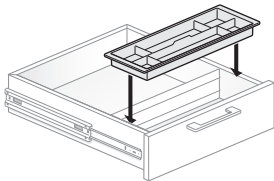

JPTA-9
Class FP

Features

- Includes one black tray.
- Suspends from sides of 6"(152mm) drawer and slides for drawer access.

To Order, Specify:

- 1) Product number.
(No finish specification required.)

Height	Depth	Width	Number	Price
Letter Width				
1.25"(32mm)	5.5"(140mm)	12.875"(327mm)	JPTA-6	\$55.79
Legal Width				
1.25"(32mm)	5.5"(140mm)	16.28125"(414mm)	JPTA-9	\$53.41

File Bars

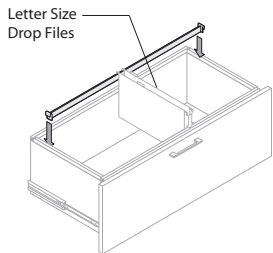

UXAH
Class YA

Features

- Includes one side-to-side hanging bar.
- Allows for side-to-side letter filing in lateral file drawer.
- Standard in black finish color only.

To Order, Specify:

- 1) Product number.
(No finish specification required.)

Width	Number	Price
30"(762mm)	UXAH-0030	\$78.07
36"(914mm)	UXAH-0036	78.07
42"(1067mm)	UXAH-0042	78.07

Accessories

Grommet

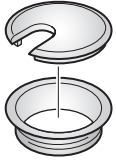

UXAG-0002
Class RA

Features

- Includes one cover.
- Must be field-installed; requires 1.75"(44mm) field drilled hole.

Specification Tips

- Available in black or satin chrome only.

To Order, Specify:

- 1) Product number.
- 2) Trim color: black or chrome.

Note: \$46.46 upcharge (list) for chrome.

Height	Inside Diameter	Outside Diameter	Number	Price
.625"(16mm)	1.75"(44mm)	2"(51mm)	UXAG-0002	\$49.76

Column Base



XZEC-NGB
Class RA

Features

- Includes 4"(102mm) diameter column, 6"(152mm) diameter mounting plate, glide and attachment hardware.
- Allows for 3"(76mm) adjustment.

Specification Tips

- For use to provide support to separately specified modular worksurfaces; recommended for use with extended corner and radius ender worksurfaces.

To Order, Specify:

- 1) Product number.
- 2) Trim color for Painted Column Base.

Description	Height	Diameter	Number	Price
Painted	28"(711mm)	4"(102mm)	XZEC-2804-NGB	\$328.48
Chrome	28"(711mm)	4"(102mm)	XZEC-2804-NGC	734.79

Masters Series Resources

Surfaces Materials

Index

Warranty

Surface Materials

Wood Finish/Color Legend





Because of the natural properties of wood, variations of grain and finish color can be expected. Haworth carefully selects materials used in the manufacturing of products to ensure consistent and acceptable color.

Wood is susceptible to color change from exposure to UV rays. Haworth controls this by using surface finishes to reduce color change. However, change may be more evident in light-colored finishes.

All Haworth Wood Casegoods receive the Haworth EcoShield™ water-based, UV cured finish, except for Suite which receives a hand-applied, water-based finish.

EcoShield and hand-applied, water-based finished products are not designed to go together and are not recommended for use within the same space.

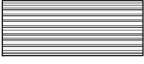
Masters Series has a water-based, UV cured EcoShield finish.

Wood Group	Veneer Type	Variety	Cutting Technique	Surface	Matching Technique	Grain Direction Drawer/Door Front	Finish Name/ Color	Specification Number
	Double Cut	Obeche	Double Cut	Open Pore	N/A Slip Match	Vertical	Applegate	2P-RL
							Dune	WE-RD
							Ebony	WJ-RE
							Echo	2N-RL
							Harbor	W3-HR
							Melba	WE-RT
	Pebble	W4-PB						
	Natural Double Cut	Walnut	Double Cut	Open Pore	N/A Slip Match	Vertical	Auburn on Walnut*	CQ-HKL
							Clove on Walnut*	CQ-HBF
Walnut Grove*							CQ-WG	
	Natural	Cherry	Plain Sliced	Semi-Open Pore	Book Rotate on Tops Slip Match All Other Surfaces	Vertical	Amber on Cherry	VC-CA1
							American on Cherry	VC-W23
							Bourbon on Cherry	VC-CPK
							Burgundy on Cherry	VC-HKF
							Caramel Cherry	VC-W33
							Heritage Cherry	VC-W30
							Pacific Cherry	VC-W32
							Toffee on Cherry	VC-HKA
	Natural	Maple	Plain Sliced	Semi-Open Pore	Book Rotate on Tops Slip Match All Other Surfaces	Vertical	Light Maple	VP-LM
							Natural Maple	VP-N
	Natural	Walnut	Plain Sliced	Open Pore	Book Rotate on Tops Slip Match All Other Surfaces	Vertical	Colombian on Walnut	VR-HKG
							Espresso on Walnut	VR-W15
							Retro on Walnut	VR-W31
	Natural	Oak	Plain Sliced	Semi-Open Pore	Book Rotate on Tops Slip Match All Other Surfaces	Vertical	Urban on Oak	VJ-HKC
	Quarter Cut	Anegre	Quarter Cut	Semi-Open Pore	N/A Slip Match	Vertical	Espresso on QC Anegre	NP-W15
							Quarter Cut	Maple
	Quarter Cut	Walnut	Quarter Cut	Open Pore	N/A Slip Match	Vertical	Clear on QC Walnut	NW-W35
							Espresso on QC Walnut	NW-W15
							Retro on QC Walnut	NW-W31
		Rift Cut	White Oak	Rift Cut	Open Pore	N/A Slip Match	Vertical	Clear on Rift Cut White Oak
Espresso on Rift Cut White Oak								NR-W15
Mocha on Rift Cut White Oak								NR-W40
D	Figured	Anegre	Quarter Slice	Semi-Open Pore	Slip Match	Vertical	Golden on Figured Anegre	VU-W08

*Finger pull (F) and profiled edges available in Walnut Grove and Wood Group B and D only.

ALERT: These materials are current, however they are being considered for future obsolescence due to low volume.

Wood

- VJ-W42 Brindle
- 2R-RL Butternut
- NW-W15 Espresso
- NP-W08 Golden
- NP-W07 Light
- NX-U Medium
- VR-W12 Naturally Walnut
- WC-RW Wenge
- VU-W07 Light Figured Anegre

Surface Materials

Finish Color Legend

HPL

Grade A

Solid Color

H-34	Beige
H-AK	Chalk
H-8J	Charcoal
H-3J	Graphite
H-62	Gray Tone
H-WL	Linen
H-3P	Platinum
H-AA	Putty
H-3E	Smoke

Patterned

H-P1	Linen Casual
H-P2	Linen Classic
H-P3	Linen Crisp
H-P4	Linen Flax

Wood Grain

H-B06	Brazilwood
H-E79	Colombian Walnut
H-AE	Maple
H-DYP	New Age Oak
H-E15	River Cherry
H-C09	Williamsburg Cherry

Grade B

Premium Wood Grain

H-C8	Blonde Modern Cherry
H-D1	Daintree
H-KP	Field Elm
H-KN	Grey Elm
H-KM	Landmark Wood
H-D2	Mocha Modern Cherry
H-KL	Neo Walnut
H-KR	Phantom Ecru
H-LS	Phantom Pearl
H-C9	Spiced Modern Cherry

Edgeband

Solid Color

HP-34	Beige
HP-AK	Chalk
HP-8J	Charcoal
HP-3J	Graphite
HP-62	Gray Tone
HP-WL	Linen
HP-3P	Platinum
HP-AA	Putty
HP-3E	Smoke

Patterned

HP-P1	Linen Casual
HP-P2	Linen Classic
HP-P3	Linen Crisp
HP-P4	Linen Flax

Wood Grain

HP-C8	Blonde Modern Cherry
HP-B06	Brazilwood
HP-E79	Colombian Walnut
HP-D1	Daintree
HP-KP	Field Elm
HP-KN	Grey Elm
HP-KM	Landmark Wood
HP-AE	Maple
HP-D2	Mocha Modern Cherry
HP-KL	Neo Walnut
HP-DYP	New Age Oak
HP-KR	Phantom Ecru
HP-LS	Phantom Pearl
HP-E15	River Cherry
HP-C9	Spiced Modern Cherry
HP-C09	Williamsburg Cherry

Trim

Grade A

Paint

LN-F	Black**
TR-R	Beige
TR-AK	Chalk
TR-K	Charcoal
TR-C1	Cocoa
TR-J	Graphite
TR-G	Gray Tone
TR-AA	Putty
TR-E	Smoke
TR-PLS	Smooth Plaster
TR-FM	Snow

Smooth

LN-F	Black**
------	---------

Textured

TR-TG	Grout
TR-TF	Pitch
TR-TW	Plaster

Grade B

Smooth

TR-1G	Blue Jay
TR-1R	Brownstone
TR-CTS	Chartreuse
TR-1N	Night
TR-1Q	Park
TR-RR	Rusty Red
TR-1M	Sable
TR-1J	Sky Blue

Smooth Metallic

TR-MC	Champagne
TR-DM	Dark Bronze
TR-LE	Silver

Textured Metallic

TR-AR	Argent
TR-HE	Hellenic

Glass

Grade A

1G-1C	Clear Tempered
-------	----------------

Grade C

1G-E21	Satin Etch Tempered
--------	---------------------

Grade H

3G-BL7	Black Back-painted Low Iron Tempered
3G-BL6	White Back - Painted Low Iron Tempered

Lock Plugs

LR-BL	Black
LR-BP	Chrome

Pulls

TR-NP	Satin Nickel
-------	--------------

*Finger pull (F) and profiled edges available in Walnut Grove and Wood Group B only.

ALERT: These materials are current, however they are being considered for future obsolescence due to low volume.

<h3>HPL</h3> <table border="0"> <tr><td>H-AM</td><td>Amber Cherry</td></tr> <tr><td>H-AD</td><td>Medium Cherry</td></tr> </table>	H-AM	Amber Cherry	H-AD	Medium Cherry	<h3>Trim</h3> <table border="0"> <tr><td>TR-1E</td><td>Accent Orange</td></tr> <tr><td>TR-1F</td><td>Accent Red</td></tr> <tr><td>TR-CTS</td><td>Chartreuse</td></tr> <tr><td>TR-1H</td><td>Terra</td></tr> <tr><td>TR-1K</td><td>Wren</td></tr> </table>	TR-1E	Accent Orange	TR-1F	Accent Red	TR-CTS	Chartreuse	TR-1H	Terra	TR-1K	Wren
H-AM	Amber Cherry														
H-AD	Medium Cherry														
TR-1E	Accent Orange														
TR-1F	Accent Red														
TR-CTS	Chartreuse														
TR-1H	Terra														
TR-1K	Wren														

Forestry Stewardship Council (FSC) Statement:

In our continuing support of sustainable forestry and responsible purchasing, Haworth North America is offering FSC certified wood products at no up-charge. By providing FSC certified material, Haworth is supporting our client's green building goals and demonstrating our collective commitment to source materials more sustainably. Haworth will provide to you the necessary FSC-certified paperwork with your shipment. For more information, FAQs, and a complete FSC product list (including product exceptions), go to the Library and search FSC.

Surface Materials

Fabrics/Color Legend

Vertical Fabrics

- Grade A**
 (6X) Chevron
 (35) Etch
 (L6) Highlands
 (C1) Striae
 (PY) Tailored
- Grade B**
 (33) Camp
 (L5) Classic
 (34) Fields
 (3JV) Hobson
 (6) Hue
 (32) Peca
 (PV) Ritz
 (WS) Shimmer
- Grade C**
 (SW) Sisal
 (45) Thorma
- Grade D**
 (6KV) Dots
 (3SV) Scapes

Seating Fabrics

- Grade A**
 (4H) Blanket
 (3J) Hobson
 (4J) Morse
 (2A) Pixel
 (3L) Novelty
 (3A) Tellure
 (XJ) Wellington
- Grade B**
 (4N) Diagonale
 (4Z) Element
 (4E) English Tweed
 (S6) Floyd by Kvadrat
 (S4) Kaleidoscope
 (SN) Pemberton
 (4V) Ramie
 (S8) Reflect by Kvadrat
 (MV) Tech
- Grade C**
 (6K) Dots
 (67) King II
 (68) Maya II
 (4T) Oceanic
 (3S) Scapes
- Grade D**
 (LN) Atlas by Kvadrat
 (4D) Big Arrow
 (1K) Big Diagonale
 (NV) Clara 2 by Kvadrat
 (JB) Ootswold
 (66) Class II
 (6M) Main Line Flax
 (S7) Melange Nap by Kvadrat
 (RP) Recheck by Kvadrat
- Grade E**
 (XG) Brisa
 (SY) Steelcut Trio 3 by Kvadrat
- Grade F**
 (SV) Divina Melange 3 by Kvadrat
 (SZ) Hallingdale 65 by Kvadrat

* For most current finish and fabric availability please reference surfaces.haworth.com.

ALERT: These materials are current, however they are being considered for future obsolescence due to low volume.

Fabrics

(PH) Birds Nest
 (1X) Gauge
 (MM) Twist

Haworth+

For information on the Haworth+ alliance program, including images and product availability, please refer to: [Haworth.com](https://www.haworth.com) > Surface Collection > Haworth+ Library

Customer's Own Material (COM)

For general Customer's Own Material (COM) information including processes and forms, please refer to: [Haworth.com](https://www.haworth.com) > Surface Collection > Resources > COM
 For information on approved COM's, please refer to: [Haworth.com](https://www.haworth.com) > Surface Collection > COM Library

COM Yardage Requirements

Masters Series Tackboard Fabric Usage

Nominal (Inches)		66"(1676mm) Roll (Linear Yards)			54"(1372mm) Roll (Linear Yards)		
Height	Width	Directional	Railroad	Non-directional	Directional	Railroad	Non-directional
Fabric Tackboards for Vertical Storage Units							
22"(559mm)	28"(711mm)	0.475	0.713		0.475	0.713	
	30"(762mm)	0.509	0.764		0.509	0.764	
	36"(914mm)	0.611	0.917		0.611	0.917	
	42"(1067mm)	0.713	1.069		0.713	1.069	
	48"(1219mm)	0.815	1.222		0.815	1.222	
	51"(1295mm)	0.866	1.299		0.866	1.299	
	57"(1448mm)	0.968	1.452		N/A	N/A	
	63"(1600mm)	1.069	1.604		N/A	N/A	
	69"(1753mm)	1.171	1.757		N/A	N/A	
	75"(1905mm)	1.273	1.910		N/A	N/A	
	81"(2057mm)	1.375	2.063		N/A	N/A	
	87"(2210mm)	1.477	2.215		N/A	N/A	
	93"(2362mm)	1.579	2.368		N/A	N/A	
Fabric Tackboards with Slat Rail for Vertical Storage Units							
22"(559mm)	28"(711mm)	0.302	0.454		0.302	0.454	
	30"(762mm)	0.324	0.486		0.324	0.486	
	36"(914mm)	0.389	0.583		0.389	0.583	
	42"(1067mm)	0.454	0.681		0.454	0.681	
	48"(1219mm)	0.519	0.778		0.519	0.778	
	51"(1295mm)	0.551	0.826		0.551	0.826	
	57"(1448mm)	0.616	0.924		N/A	N/A	
	63"(1600mm)	0.681	1.021		N/A	N/A	
	69"(1753mm)	0.745	1.118		N/A	N/A	
	75"(1905mm)	0.810	1.215		N/A	N/A	
	81"(2057mm)	0.875	1.313		N/A	N/A	
	87"(2210mm)	0.940	1.410		N/A	N/A	
	93"(2362mm)	1.005	1.507		N/A	N/A	
Fabric Tackboards for Overhead Storage Units							
24"(610mm)	30"(762mm)	0.556	0.833		0.556	0.833	
	31"(787mm)	0.574	0.861		0.574	0.861	
	36"(914mm)	0.667	1.000		0.667	1.000	
	37"(940mm)	0.685	1.028		0.685	1.028	
	42"(1067mm)	0.778	1.167		0.778	1.167	
	48"(1219mm)	0.889	1.333		0.889	1.333	
	54"(1372mm)	1.000	1.500		N/A	N/A	
	60"(1524mm)	1.110	1.667		N/A	N/A	
	66"(1676mm)	1.222	1.833		N/A	N/A	
	72"(1829mm)	1.333	2.000		N/A	N/A	
	78"(1981mm)	1.444	2.167		N/A	N/A	
	84"(2134mm)	1.556	2.333		N/A	N/A	
	90"(2286mm)	1.667	2.500		N/A	N/A	
	96"(2438mm)	1.778	2.667		N/A	N/A	

COM Yardage Requirements

Masters Series Tackboard Fabric Usage

Nominal (Inches)		66"(1676mm) Roll (Linear Yards)			54"(1372mm) Roll (Linear Yards)		
Height	Width	Directional	Railroad	Non-directional	Directional	Railroad	Non-directional
Fabric Tackboards with Slat Rail for Overhead Storage Units							
24"(610mm)	30"(762mm)	0.370	0.556		0.370	0.556	
	31"(787mm)	0.383	0.574		0.383	0.574	
	36"(914mm)	0.444	0.667		0.444	0.667	
	37"(940mm)	0.457	0.685		0.457	0.685	
	42"(1067mm)	0.519	0.778		0.519	0.778	
	48"(1219mm)	0.593	0.889		0.593	0.889	
	54"(1372mm)	0.667	1.000		N/A	N/A	
	60"(1524mm)	0.741	1.111		N/A	N/A	
	66"(1676mm)	0.815	1.222		N/A	N/A	
	72"(1829mm)	0.889	1.333		N/A	N/A	
	78"(1981mm)	0.963	1.444		N/A	N/A	
	84"(2134mm)	1.037	1.556		N/A	N/A	
	90"(2286mm)	1.111	1.667		N/A	N/A	
	96"(2438mm)	1.185	1.778		N/A	N/A	
Fabric Tackboards for Reception Stations							
12.5"(305mm)	72"(1829mm)	0.722	1.083		N/A	N/A	
	84"(2134mm)	0.843	1.264		N/A	N/A	

Index

Products are listed alphabetically in this index by alpha-numeric prefix/suffix codes.

Product Code	Product Description	Page
JPTA-6	Accessories – Pencil Tray	.189
JPTA-9	Accessories – Pencil Tray	.189
MTSV	Vertical Storage Unit – Tackboard — Fabric and Slat Rail	.67
MTSW	Wall Mount Tackboard – For Overhead Storage Units — Fabric and Slat Rail	.85
MTVD	Vertical Storage Unit – Tackboard — Fabric	.67
MTWD	Wall Mount Tackboard – For Overhead Storage Units — Fabric	.84
MZWK	Wall Mount Tile Kit	.79
UFXS	Modular Components – Adaptable Hinged Modesty Panel	.134
UGWT	Wall Mount Frameless Glass Tile	.82
ULB2-S	Bookcase	.185
ULB3-S	Bookcase	.185
ULB4-S	Bookcase	.185
ULB5-S	Bookcase	.185
ULB6-S	Bookcase	.185
ULLD-SN	Overhead Storage Unit – 1.5H Glass Sliding Door	.114
ULLD-SN	Overhead Storage Unit – 1H Glass Sliding Door	.112
ULLD-SN	Overhead Storage Unit – 2H Glass Sliding Door	.116
ULLL-SN	Overhead Storage Unit – 1.5H Glass Sliding Door	.114
ULLL-SN	Overhead Storage Unit – 1H Glass Sliding Door	.112
ULLL-SN	Overhead Storage Unit – 2H Glass Sliding Door	.116
ULMD-SL	Overhead Storage Unit – 1.5H Glass Hinged Doors	.108
ULMD-SL	Overhead Storage Unit – 1H Glass Hinged Doors	.106
ULMD-SL	Overhead Storage Unit – 2H Glass Hinged Doors	.110
ULMD-SN	Overhead Storage Unit – 1.5H Glass Hinged Doors	.108
ULMD-SN	Overhead Storage Unit – 1H Glass Hinged Doors	.106
ULMD-SN	Overhead Storage Unit – 1H Glass Hinged Doors	.106
ULMD-SN	Overhead Storage Unit – 1H Glass Hinged Doors	.106
ULMD-SN	Overhead Storage Unit – 2H Glass Hinged Doors	.110
ULMD-SN	Overhead Storage Unit – 2H Glass Hinged Doors	.110
ULMD-SN	Overhead Storage Unit – 2H Glass Hinged Doors	.110
ULMD-SN	Overhead Storage Unit – 2H Glass Hinged Doors	.110
ULML-SL	Overhead Storage Unit – 1.5H Glass Hinged Doors	.108
ULML-SL	Overhead Storage Unit – 1H Glass Hinged Doors	.106
ULML-SL	Overhead Storage Unit – 2H Glass Hinged Doors	.110
ULML-SN	Overhead Storage Unit – 1.5H Glass Hinged Doors	.108
ULML-SN	Overhead Storage Unit – 1H Glass Hinged Doors	.106
ULML-SN	Overhead Storage Unit – 1H Glass Hinged Doors	.106
ULML-SN	Overhead Storage Unit – 1H Glass Hinged Doors	.106
ULML-SN	Overhead Storage Unit – 2H Glass Hinged Doors	.110
ULML-SN	Overhead Storage Unit – 2H Glass Hinged Doors	.110
ULML-SN	Overhead Storage Unit – 2H Glass Hinged Doors	.110
ULND-SN	Overhead Storage Unit – 1H Open	.90
ULND-SN	Overhead Storage Unit – 2H Open	.92
ULNL-SN	Overhead Storage Unit – 1H Open	.90
ULNL-SN	Overhead Storage Unit – 2H Open	.92
ULOD-SL	Overhead Storage Unit – 1.5H Hinged Doors	.96
ULOD-SL	Overhead Storage Unit – 1H Hinged Doors	.94
ULOD-SL	Overhead Storage Unit – 2H Hinged Doors	.98
ULOD-SN	Overhead Storage Unit – 1.5H Hinged Doors	.96
ULOD-SN	Overhead Storage Unit – 1H Hinged Doors	.94
ULOD-SN	Overhead Storage Unit – 1H Hinged Doors	.94
ULOD-SN	Overhead Storage Unit – 1H Hinged Doors	.94

Index

Product Code	Product Description	Page
ULOD-SN	Overhead Storage Unit – 2H Hinged Doors	.98
ULOD-SN	Overhead Storage Unit – 2H Hinged Doors	.98
ULOD-SN	Overhead Storage Unit – 2H Hinged Doors	.98
ULOL-SL	Overhead Storage Unit – 1.5H Hinged Doors	.96
ULOL-SL	Overhead Storage Unit – 1H Hinged Doors	.94
ULOL-SL	Overhead Storage Unit – 2H Hinged Doors	.98
ULOL-SN	Overhead Storage Unit – 1.5H Hinged Doors	.96
ULOL-SN	Overhead Storage Unit – 1H Hinged Doors	.94
ULOL-SN	Overhead Storage Unit – 1H Hinged Doors	.94
ULOL-SN	Overhead Storage Unit – 1H Hinged Doors	.94
ULOL-SN	Overhead Storage Unit – 2H Hinged Doors	.98
ULOL-SN	Overhead Storage Unit – 2H Hinged Doors	.98
ULOL-SN	Overhead Storage Unit – 2H Hinged Doors	.98
ULRD-SN	Overhead Storage Unit – 1.5H Sliding Door	.102
ULRD-SN	Overhead Storage Unit – 1H Sliding Door	.100
ULRD-SN	Overhead Storage Unit – 2H Sliding Door	.104
ULRL-SN	Overhead Storage Unit – 1.5H Sliding Door	.102
ULRL-SN	Overhead Storage Unit – 1H Sliding Door	.100
ULRL-SN	Overhead Storage Unit – 2H Sliding Door	.104
ULSE	Modular Components – 2H End Panel	.137
ULSL	Modular Components – L-Support Panel	.138
ULSL-SL	Modular Components – 2H Partial Depth L-Support Panel	.140
ULSL-SR	Modular Components – 2H Partial Depth L-Support Panel	.140
ULSS-S	Modular Components – Mid-Support Panel	.142
ULSX-SN	Modular Components – 2H Support Panel	.142
ULVL	Wall Mount L Shelf	.75
ULWL	Wall Mount Open Sided Shelf	.68
ULXF-SS	Modular Components – Full-Overlay Modesty Panel	.132
ULXH-SN2	Modular Components – Hinged Modesty Panel	.133
ULXS	Modular Components – Adaptable Hinged Modesty Panel	.134
UMW8	Wall Mount Floating Metal Shelf	.78
UMWD	Wall Mount Floating Metal Shelf	.78
UMWL	Wall Mount Floating Metal Shelf	.78
UMWX	Wall Mount Floating Metal Shelf	.78
UXAG-0002	Accessories – Grommet	.190
UXAH	Accessories – File Bars	.189
UXB2-S	Bookcase	.185
UXB3-S	Bookcase	.185
UXB4-S	Bookcase	.185
UXB5-S	Bookcase	.185
UXB6-S	Bookcase	.185
UXCD	Accessories – Center Drawer	.189
UXLD-SN	Overhead Storage Unit – 1.5H Glass Sliding Door	.114
UXLD-SN	Overhead Storage Unit – 1H Glass Sliding Door	.112
UXLD-SN	Overhead Storage Unit – 2H Glass Sliding Door	.116
UXLL-SN	Overhead Storage Unit – 1.5H Glass Sliding Door	.114
UXLL-SN	Overhead Storage Unit – 1H Glass Sliding Door	.112
UXLL-SN	Overhead Storage Unit – 2H Glass Sliding Door	.116
UXMD-SL	Overhead Storage Unit – 1.5H Glass Hinged Doors	.108
UXMD-SL	Overhead Storage Unit – 1H Glass Hinged Doors	.106
UXMD-SL	Overhead Storage Unit – 2H Glass Hinged Doors	.110
UXMD-SN	Overhead Storage Unit – 1.5H Glass Hinged Doors	.108

Index

Product Code	Product Description	Page
UXMD-SN	Overhead Storage Unit – 1H Glass Hinged Doors	.106
UXMD-SN	Overhead Storage Unit – 1H Glass Hinged Doors	.106
UXMD-SN	Overhead Storage Unit – 1H Glass Hinged Doors	.106
UXMD-SN	Overhead Storage Unit – 2H Glass Hinged Doors	.110
UXMD-SN	Overhead Storage Unit – 2H Glass Hinged Doors	.110
UXMD-SN	Overhead Storage Unit – 2H Glass Hinged Doors	.110
UXML-SL	Overhead Storage Unit – 1.5H Glass Hinged Doors	.108
UXML-SL	Overhead Storage Unit – 1H Glass Hinged Doors	.106
UXML-SL	Overhead Storage Unit – 2H Glass Hinged Doors	.110
UXML-SN	Overhead Storage Unit – 1.5H Glass Hinged Doors	.108
UXML-SN	Overhead Storage Unit – 1H Glass Hinged Doors	.106
UXML-SN	Overhead Storage Unit – 1H Glass Hinged Doors	.106
UXML-SN	Overhead Storage Unit – 1H Glass Hinged Doors	.106
UXML-SN	Overhead Storage Unit – 2H Glass Hinged Doors	.110
UXML-SN	Overhead Storage Unit – 2H Glass Hinged Doors	.110
UXML-SN	Overhead Storage Unit – 2H Glass Hinged Doors	.110
UXND-SN	Overhead Storage Unit – 1H Open	.90
UXND-SN	Overhead Storage Unit – 2H Open	.92
UXNL-SN	Overhead Storage Unit – 1H Open	.90
UXNL-SN	Overhead Storage Unit – 2H Open	.92
UXOD-SL	Overhead Storage Unit – 1.5H Hinged Doors	.96
UXOD-SL	Overhead Storage Unit – 1H Hinged Doors	.94
UXOD-SL	Overhead Storage Unit – 2H Hinged Doors	.98
UXOD-SN	Overhead Storage Unit – 1.5H Hinged Doors	.96
UXOD-SN	Overhead Storage Unit – 1H Hinged Doors	.94
UXOD-SN	Overhead Storage Unit – 1H Hinged Doors	.94
UXOD-SN	Overhead Storage Unit – 1H Hinged Doors	.94
UXOD-SN	Overhead Storage Unit – 2H Hinged Doors	.98
UXOD-SN	Overhead Storage Unit – 2H Hinged Doors	.98
UXOD-SN	Overhead Storage Unit – 2H Hinged Doors	.98
UXOL-SL	Overhead Storage Unit – 1.5H Hinged Doors	.96
UXOL-SL	Overhead Storage Unit – 1H Hinged Doors	.94
UXOL-SL	Overhead Storage Unit – 2H Hinged Doors	.98
UXOL-SN	Overhead Storage Unit – 1.5H Hinged Doors	.96
UXOL-SN	Overhead Storage Unit – 1H Hinged Doors	.94
UXOL-SN	Overhead Storage Unit – 1H Hinged Doors	.94
UXOL-SN	Overhead Storage Unit – 1H Hinged Doors	.94
UXOL-SN	Overhead Storage Unit – 2H Hinged Doors	.98
UXOL-SN	Overhead Storage Unit – 2H Hinged Doors	.98
UXOL-SN	Overhead Storage Unit – 2H Hinged Doors	.98
UXRD-SN	Overhead Storage Unit – 1.5H Sliding Door	.102
UXRD-SN	Overhead Storage Unit – 1H Sliding Door	.100
UXRD-SN	Overhead Storage Unit – 2H Sliding Door	.104
UXRL-SN	Overhead Storage Unit – 1.5H Sliding Door	.102
UXRL-SN	Overhead Storage Unit – 1H Sliding Door	.100
UXRL-SN	Overhead Storage Unit – 2H Sliding Door	.104
UXSE	Modular Components – 2H End Panel	.137
UXSL	Modular Components – L-Support Panel	.138
UXSL-SL	Modular Components – 2H Partial Depth L-Support Panel	.140
UXSL-SR	Modular Components – 2H Partial Depth L-Support Panel	.140
UXSS-S	Modular Components – Mid-Support Panel	.142
UXSX-SN	Modular Components – 2H Support Panel	.142

Index

Product Code	Product Description	Page
UXVL	Wall Mount L Shelf	.75
UXWA	Accessories – Counterweight	.188
UXWL	Wall Mount Open Sided Shelf	.68
UXXF-SS	Modular Components – Full-Overlay Modesty Panel	.132
UXXH-SN2	Modular Components – Hinged Modesty Panel	.133
UXXS	Modular Components – Adaptable Hinged Modesty Panel	.134
W111-5298	Accessories – Tetra Bracket	.188
X4AD-WL	Personal Storage Tower – 5H and 6H F/F Pedestal and Valet	.176
X4AF-WL	Personal Storage Tower – 5H and 6H F/F Pedestal and Valet	.178
X4CA-2348	Storage Unity – 2H Attached Sliding Door – 23" Depth	.162
X4CB-2348	Storage Unit – 1.5H Attached Sliding Door – 23" Depth	.160
X4CD-SW	Stack-On Storage Cabinet – Hinged Doors	.121
X4CL-SW	Stack-On Storage Cabinet – Hinged Doors	.121
X4F1-LW	Lateral File – Attached	.149
X4F3-LW	Lateral File – 3H and 4H Freestanding	.166
X4F4-LW	Lateral File – 3H and 4H Freestanding	.166
X4F5-LW	Lateral File – 5H and 6H Freestanding	.168
X4F6-LW	Lateral File – 5H and 6H Freestanding	.168
X4FA-LW	Lateral File – Attached	.149
X4FB-LW	Lateral File – Attached	.149
X4FP-LW	Lateral File – Attached	.149
X4FV-LW	Lateral File – Attached Open Shelf	.147
X4H2	Storage Unit – 1.5 or 2H Doors	.154
X4H3-LW	Storage Unit – 3H Freestanding with Hinged Doors	.165
X4HB	Storage Unit – 1.5 or 2H Doors	.154
X4JD-ST	Stack-On Storage Cabinet – Glass Doors	.123
X4JL-ST	Stack-On Storage Cabinet – Glass Doors	.123
X4KD-SN	Stack-On Bookcase	.119
X4KL-SN	Stack-On Bookcase	.119
X4LD-NT	Vertical Storage Unit – 1H Glass Sliding Door	.63
X4LD-NT	Vertical Storage Unit – 2H Glass Sliding Door	.65
X4LL-NT	Vertical Storage Unit – 1H Glass Sliding Door	.63
X4LL-NT	Vertical Storage Unit – 2H Glass Sliding Door	.65
X4M5-LW	Lateral File – 5H and 6H Combination Unit	.170
X4M6-LW	Lateral File – 5H and 6H Combination Unit	.170
X4N1-NN	Storage Unit – Attached	.151
X4N2-NN	Storage Unit – Attached	.151
X4N3-NN	Storage Unit – 3H Freestanding Open	.164
X4NB-NN	Storage Unit – Attached	.151
X4PA-NW	Pedestal – Attached	.143
X4PB-1860	Storage Unit – 1.5H Attached Open for use with Convergent Worktop	.153
X4PM-BW	Pedestal – Mobile	.145
X4RD-NW	Vertical Storage Unit – 1H Sliding Door	.55
X4RD-NW	Vertical Storage Unit – 2H Sliding Door	.57
X4RL-NW	Vertical Storage Unit – 1H Sliding Door	.55
X4RL-NW	Vertical Storage Unit – 2H Sliding Door	.57
X4SA-1848	Storage Unit – 2H Attached Sliding Door – 18" Depth	.158
X4SB-1848	Storage Unit – 1.5H Attached Sliding Door – 18" Depth	.156
X4SD-LT	Vertical Storage Units – 1H Glass Hinged Doors	.59
X4SD-NT	Vertical Storage Unit – 2H Glass Hinged Doors	.61
X4SD-NT	Vertical Storage Unit – 2H Glass Hinged Doors	.61
X4SD-NT	Vertical Storage Unit – 2H Glass Hinged Doors	.61

Index

Product Code	Product Description	Page
X4SD-NT	Vertical Storage Units – 1H Glass Hinged Doors	.59
X4SD-NT	Vertical Storage Units – 1H Glass Hinged Doors	.59
X4SD-NT	Vertical Storage Units – 1H Glass Hinged Doors	.59
X4SL-LT	Vertical Storage Unit – 2H Glass Hinged Doors	.61
X4SL-LT	Vertical Storage Units – 1H Glass Hinged Doors	.59
X4SL-NT	Vertical Storage Unit – 2H Glass Hinged Doors	.61
X4SL-NT	Vertical Storage Unit – 2H Glass Hinged Doors	.61
X4SL-NT	Vertical Storage Unit – 2H Glass Hinged Doors	.61
X4SL-NT	Vertical Storage Units – 1H Glass Hinged Doors	.59
X4SL-NT	Vertical Storage Units – 1H Glass Hinged Doors	.59
X4SL-NT	Vertical Storage Units – 1H Glass Hinged Doors	.59
X4UD-NN	Vertical Storage Unit – 1H Open	.47
X4UD-NN	Vertical Storage Unit – 2H Open	.49
X4UL-NN	Vertical Storage Unit – 1H Open	.47
X4UL-NN	Vertical Storage Unit – 2H Open	.49
X4VD-LW	Vertical Storage Unit – 1H Hinged Doors	.51
X4VD-LW	Vertical Storage Unit – 2H Hinged Doors	.53
X4VD-NW	Vertical Storage Unit – 1H Hinged Doors	.51
X4VD-NW	Vertical Storage Unit – 1H Hinged Doors	.51
X4VD-NW	Vertical Storage Unit – 1H Hinged Doors	.51
X4VD-NW	Vertical Storage Unit – 2H Hinged Doors	.53
X4VD-NW	Vertical Storage Unit – 2H Hinged Doors	.53
X4VD-NW	Vertical Storage Unit – 2H Hinged Doors	.53
X4VL-LW	Vertical Storage Unit – 1H Hinged Doors	.51
X4VL-LW	Vertical Storage Unit – 2H Hinged Doors	.53
X4VL-NW	Vertical Storage Unit – 1H Hinged Doors	.51
X4VL-NW	Vertical Storage Unit – 1H Hinged Doors	.51
X4VL-NW	Vertical Storage Unit – 1H Hinged Doors	.51
X4VL-NW	Vertical Storage Unit – 2H Hinged Doors	.53
X4VL-NW	Vertical Storage Unit – 2H Hinged Doors	.53
X4VL-NW	Vertical Storage Unit – 2H Hinged Doors	.53
X4W5-WL	Wardrobe – 5H and 6H Open Unit	.172
X4W6-WL	Wardrobe – 5H and 6H Open Unit	.172
X4X5-LW	Wardrobe – 5H and 6H Closed Storage Unit	.174
X4X6-LW	Wardrobe – 5H and 6H Closed Storage Unit	.174
X4Y5-WR	Wardrobe – 5H and 6H	.182
X4Y6-WR	Wardrobe – 5H and 6H	.182
X4ZF-WR	Storage Tower – 5H and 6H	.180
X5AD-LL	Personal Storage Tower – 5H and 6H F/F Pedestal and Valet	.176
X5AF-LL	Personal Storage Tower – 5H and 6H F/F Pedestal and Valet	.178
X5CA-2348	Storage Unity – 2H Attached Sliding Door – 23" Depth	.162
X5CB-2348	Storage Unit – 1.5H Attached Sliding Door – 23" Depth	.160
X5CD-SW	Stack-On Storage Cabinet – Hinged Doors	.121
X5CL-SW	Stack-On Storage Cabinet – Hinged Doors	.121
X5F1-LL	Lateral File – Attached	.149
X5F3-LL	Lateral File – 3H and 4H Freestanding	.166
X5F4-LL	Lateral File – 3H and 4H Freestanding	.166
X5F5-LL	Lateral File – 5H and 6H Freestanding	.168
X5F6-LL	Lateral File – 5H and 6H Freestanding	.168
X5FA-LL	Lateral File – Attached	.149
X5FB-LL	Lateral File – Attached	.149
X5FP-LL	Lateral File – Attached	.149

Index

Product Code	Product Description	Page
X5FV-LW	Lateral File – Attached Open Shelf	.147
X5H2	Storage Unit – 1.5 or 2H Doors	.154
X5H3-LL	Storage Unit – 3H Freestanding with Hinged Doors	.165
X5HB	Storage Unit – 1.5 or 2H Doors	.154
X5JD-ST	Stack-On Storage Cabinet – Glass Doors	.123
X5JL-ST	Stack-On Storage Cabinet – Glass Doors	.123
X5KD-SN	Stack-On Bookcase	.119
X5KL-SN	Stack-On Bookcase	.119
X5LD-NT	Vertical Storage Unit – 1H Glass Sliding Door	.63
X5LD-NT	Vertical Storage Unit – 2H Glass Sliding Door	.65
X5LL-NT	Vertical Storage Unit – 1H Glass Sliding Door	.63
X5LL-NT	Vertical Storage Unit – 2H Glass Sliding Door	.65
X5M5-LL	Lateral File – 5H and 6H Combination Unit	.170
X5M6-LL	Lateral File – 5H and 6H Combination Unit	.170
X5N1-NN	Storage Unit – Attached	.151
X5N2-NN	Storage Unit – Attached	.151
X5N3-NN	Storage Unit – 3H Freestanding Open	.164
X5NB-NN	Storage Unit – Attached	.151
X5PA-NL	Pedestal – Attached	.143
X5PB-1830	Storage Unit – 1.5H Attached Open for use with Convergent Worktop	.153
X5RD-NL	Vertical Storage Unit – 1H Sliding Door	.55
X5RD-NL	Vertical Storage Unit – 2H Sliding Door	.57
X5RL-NL	Vertical Storage Unit – 1H Sliding Door	.55
X5RL-NL	Vertical Storage Unit – 2H Sliding Door	.57
X5SA-1848	Storage Unit – 2H Attached Sliding Door – 18” Depth	.158
X5SB-1848	Storage Unit – 1.5H Attached Sliding Door – 18” Depth	.156
X5SD-LT	Vertical Storage Unit – 2H Glass Hinged Doors	.61
X5SD-LT	Vertical Storage Units – 1H Glass Hinged Doors	.59
X5SD-NT	Vertical Storage Unit – 2H Glass Hinged Doors	.61
X5SD-NT	Vertical Storage Unit – 2H Glass Hinged Doors	.61
X5SD-NT	Vertical Storage Unit – 2H Glass Hinged Doors	.61
X5SD-NT	Vertical Storage Units – 1H Glass Hinged Doors	.59
X5SD-NT	Vertical Storage Units – 1H Glass Hinged Doors	.59
X5SD-NT	Vertical Storage Units – 1H Glass Hinged Doors	.59
X5SD-NT	Vertical Storage Units – 1H Glass Hinged Doors	.59
X5SD-NT	Vertical Storage Units – 1H Glass Hinged Doors	.59
X5SL-LT	Vertical Storage Unit – 2H Glass Hinged Doors	.61
X5SL-LT	Vertical Storage Unit – 2H Glass Hinged Doors	.61
X5SL-LT	Vertical Storage Units – 1H Glass Hinged Doors	.59
X5SL-NT	Vertical Storage Unit – 2H Glass Hinged Doors	.61
X5SL-NT	Vertical Storage Unit – 2H Glass Hinged Doors	.61
X5SL-NT	Vertical Storage Unit – 2H Glass Hinged Doors	.61
X5SL-NT	Vertical Storage Units – 1H Glass Hinged Doors	.59
X5SL-NT	Vertical Storage Units – 1H Glass Hinged Doors	.59
X5SL-NT	Vertical Storage Units – 1H Glass Hinged Doors	.59
X5UD-NN	Vertical Storage Unit – 1H Open	.47
X5UD-NN	Vertical Storage Unit – 2H Open	.49
X5UL-NN	Vertical Storage Unit – 1H Open	.47
X5UL-NN	Vertical Storage Unit – 2H Open	.49
X5VD-LL	Vertical Storage Unit – 1H Hinged Doors	.51
X5VD-LL	Vertical Storage Unit – 2H Hinged Doors	.53
X5VD-NL	Vertical Storage Unit – 1H Hinged Doors	.51
X5VD-NL	Vertical Storage Unit – 1H Hinged Doors	.51
X5VD-NL	Vertical Storage Unit – 1H Hinged Doors	.51

Index

Product Code	Product Description	Page
X5VD-NL	Vertical Storage Unit – 2H Hinged Doors	.53
X5VD-NL	Vertical Storage Unit – 2H Hinged Doors	.53
X5VD-NL	Vertical Storage Unit – 2H Hinged Doors	.53
X5VL-LL	Vertical Storage Unit – 1H Hinged Doors	.51
X5VL-LL	Vertical Storage Unit – 2H Hinged Doors	.53
X5VL-NL	Vertical Storage Unit – 1H Hinged Doors	.51
X5VL-NL	Vertical Storage Unit – 1H Hinged Doors	.51
X5VL-NL	Vertical Storage Unit – 1H Hinged Doors	.51
X5VL-NL	Vertical Storage Unit – 2H Hinged Doors	.53
X5VL-NL	Vertical Storage Unit – 2H Hinged Doors	.53
X5VL-NL	Vertical Storage Unit – 2H Hinged Doors	.53
X5W5-LL	Wardrobe – 5H and 6H Open Unit	.172
X5W6-LL	Wardrobe – 5H and 6H Open Unit	.172
X5X5-LL	Wardrobe – 5H and 6H Closed Storage Unit	.174
X5X6-LL	Wardrobe – 5H and 6H Closed Storage Unit	.174
X5Y5-LR	Wardrobe – 5H and 6H	.182
X5Y6-LR	Wardrobe – 5H and 6H	.182
X5ZF-LR	Storage Tower – 5H and 6H	.180
X7PM-BW	Pedestal – Mobile	.145
XLAR-3060	Height Adjustable Table Desk – T-Leg Base	.21
XLAR-3072	Table Desk – Hoop Leg	.20
XLAS	Wardrobe – Fixed Boot Shelf	.184
XLBF-FS	Bridge	.41
XLBF-NS	Bridge	.41
XLBR-SR	Return Top	.44
XLBR-SR	Return Top	.44
XLCN-22	Corner Shell	.43
XLDF-LF	Double Pedestal Desk – Full Overlay Modesty	.17
XLFS-SN	Modular Components – T-Support Panel	.141
XLGS	Modular Components – L-Support Panel	.138
XLND-NS	Convergent D-Worktop – Column	.39
XLNG-4260	Height Adjustable Convergent Worktop – Wedge Radius – T-Leg	.27
XLNG-4272	Convergent Worktop for use with 1.5H Storage – Wedge Radius with Column or Hoop	.31
XLNP-LS	Convergent P-Worktop – Column	.40
XLNP-RS	Convergent P-Worktop – Column	.40
XLNR-3060	Height Adjustable Convergent Worktop – Rectangular – T-Leg	.23
XLNR-3072	Convergent Worktop for use with 1.5H Storage – Rectangular with Column or Hoop	.29
XLNW-4260	Height Adjustable Convergent Worktop – Wedge Square– T-Leg	.25
XLNW-4272	Convergent Worktop for use with 1.5H Storage – Wedge Square with Column or Hoop	.30
XLS1-3060	Shroud – Use with Height Adjustable T-Leg	.32
XLSF-LF	Single Pedestal Desk – Full Overlay Modesty	.15
XLST	Wall Mount Spacers	.88
XLTH-FL	Convergent T-Worktop	.34
XLWF	Modular Components – Bookcase Top	.128
XLWF	Modular Components – Credenza Top	.129
XLWT-SN	Modular Components – Storage Top	.127
XLXS-2260	Modesty Panel – Use with Shroud	.33
XLYD-SF	Convergent D-Worktop – T-Support and Column	.35
XLYD-SP	Convergent D-Worktop – T-Support and Column	.35
XLYH-SF	Desk Shell	.19
XLYP-SF	Convergent P-Worktop – T-Support and Column	.37
XLYP-SP	Convergent P-Worktop – T-Support and Column	.37

Index

Product Code	Product Description	Page
XLZR-2460	Height Adjustable Credenza Desk – T-Leg Base	.45
XMFT-8100	Wall Mount Vertical Filler Trim	.89
XPLR-RB	Reception Station – L-Shaped	.125
XTNP-RS	Convergent P-Worktop – Column	.40
XWBB	Overhead Storage Unit – Mounting Bracket to Enclose	.118
XWWF	Modular Components – Bookcase Top	.128
XXAS	Wardrobe – Fixed Boot Shelf	.184
XZAM-1S	Table – Round	.187
XZAR-3060	Height Adjustable Table Desk – T-Leg Base	.21
XZAR-3072	Table Desk – Hoop Leg	.20
XZBF-FS	Bridge	.41
XZBF-NS	Bridge	.41
XZBR-SR	Return Top	.44
XZBR-SR	Return Top	.44
XZCN-22	Corner Shell	.43
XZDF-WF	Double Pedestal Desk – Full Overlay Modesty	.17
XZEC-NGB	Accessories – Column Base	.190
XZFS-SN	Modular Components – T-Support Panel	.141
XZGS	Modular Components – L-Support Panel	.138
XZND-NS	Convergent D-Worktop – Column	.39
XZNG-4260	Height Adjustable Convergent Worktop – Wedge Radius – T-Leg	.27
XZNG-4272	Convergent Worktop for use with 1.5H Storage – Wedge Radius with Column or Hoop	.31
XZNP-LS	Convergent P-Worktop – Column	.40
XZNP-RS	Convergent P-Worktop – Column	.40
XZNR-3060	Height Adjustable Convergent Worktop – Rectangular – T-Leg	.23
XZNR-3072	Convergent Worktop for use with 1.5H Storage – Rectangular with Column or Hoop	.29
XZNW-4260	Height Adjustable Convergent Worktop – Wedge Square– T-Leg	.25
XZNW-4272	Convergent Worktop for use with 1.5H Storage – Wedge Square with Column or Hoop	.30
XZS1-3060	Shroud – Use with Height Adjustable T-Leg	.32
XZSC-2116-FA	Pedestal – Storage Cushion	.146
XZSF-WF	Single Pedestal Desk – Full Overlay Modesty	.15
XZTH-FL	Convergent T-Worktop	.34
XZUR-RB	Reception Station – U-Shaped	.126
XZWF	Modular Components – Credenza Top	.129
XZWT-SN	Modular Components – Storage Top	.127
XZXS-2260	Modesty Panel – Use with Shroud	.33
XZYB-SF	Convergent D-Worktop – T-Support and Column	.35
XZYD-SP	Convergent D-Worktop – T-Support and Column	.35
XZYH-SF	Desk Shell	.19
XZYP-SF	Convergent P-Worktop – T-Support and Column	.37
XZYP-SP	Convergent P-Worktop – T-Support and Column	.37
XZZR-2460	Height Adjustable Credenza Desk – T-Leg Base	.45
ZUBF-0000-PN	Accessories – Flush Mount Plate	.188

Product Compatibility and Limited Warranty Policy

Great Expectations

You have them as a Haworth customer and so do we. And because we value our customers, we cover our products with the Haworth North America Product Compatibility and Limited Warranty Policy.

Our Commitment To Product Compatibility – Integrated Product Platforms

As a market leader in the design and manufacture of workspaces that adapt to change, we strive to maintain product compatibility within our various generations of integrated product platforms. This benefits the customer who desires to update or modify their work environment. It also benefits the customer needing to replace a product due to damage or other reasons but which is no longer manufactured or is otherwise unavailable, such as a fabric or finish that is discontinued because of changing market preferences. In both circumstances, we often can provide products with comparable function and performance.

Our Commitment To Product Quality – The Haworth North America Limited Warranty

To ensure customer satisfaction and peace of mind, we stand behind our products with the Haworth North America Limited Warranty. To review the current version of the limited warranty including its terms and conditions, please go to:

www.haworth.com/warranty or contact OneTouch@Haworth.com or 1 877 429 6784.

Warranty Requests or Questions

For questions or service requests pertaining to the Haworth Limited Warranty, please contact your Haworth dealer.

If you are unsure who your dealer is, please contact **OneTouch@Haworth.com or 1 877 429 6784.**

Terms of Sale

The Terms of Sale apply to all products in the North America Price Lists. To review the current version of the North American Terms of Sale, please go to:

www.haworth.com/terms-of-sale or contact OneTouch@Haworth.com or 1 877 429 6784.

HAWORTH

HAWORTH® is a registered trademark of Haworth, Inc.
© Haworth, Inc. All rights reserved. 2025 3.25
haworth.com | 800 344 2600