

HAWORTH

Haworth Pricing Surcharge

A non-discountable 1.75% of list price surcharge will be applied to all orders placed after April 07, 2025

Height Adjustable Tables and Benching

North America Price List / Specification Guide – February 2025

Includes Upside, Planes and Planes LT Height Adjustable Tables and Benching

This Price List is Based Upon Haworth's February 2024 Commercial Pricing

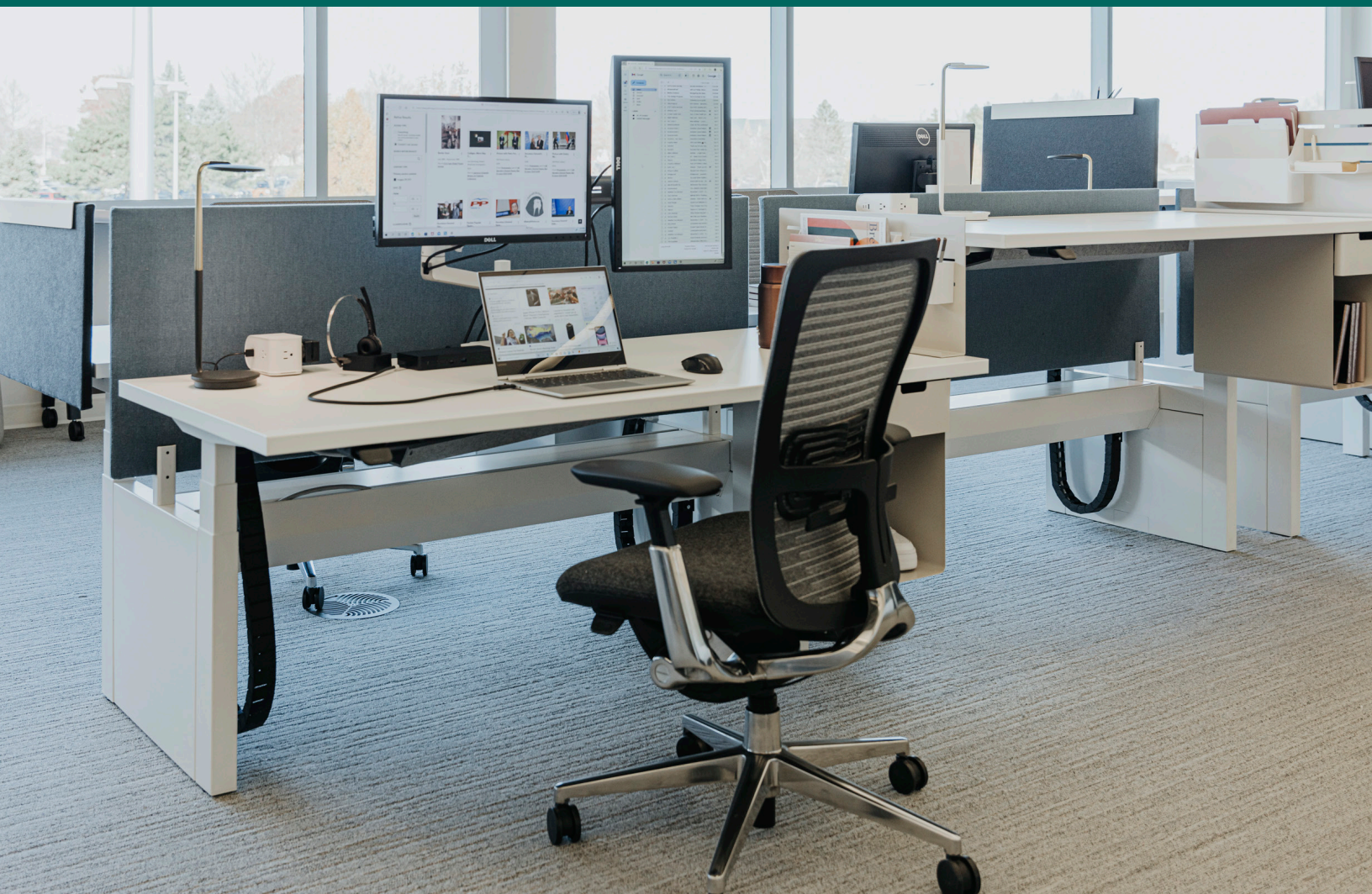

Electronic Update Page – Height Adjustable Tables

- The table below lists all of the updates and addendums added to this price list since the original version was created.
- All **Update** pages will replace the existing pages within the document.
- All **New** pages will be placed at the back of the document.

Link	Date	Pages	Description
Click Here	April 2025	All Price List Pages	Update – Pricing Surcharge – effective April 7, 2025 all future orders will have a non-discountable 1.75% of list price surcharge added.



This Haworth North American price book contains US list prices.

Canadian customers can convert the US list price into their Canadian equivalent by going to www.Haworth.com/Canada to find the current Canadian multipliers. These multiplier factors allow you to convert the US list price into a Canadian list price.

Haworth Price List Overview

Tips for Using Haworth Price Lists

The following overview explains how information is organized within the Height Adjustable Tables price list (Includes Upside®, Planes® and Jive® Tables).

Navigation Links

Use the links to jump back and forth to relevant pages.

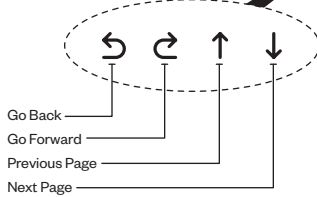

Navigation Links

Use the links to jump back and forth to relevant pages.

Go Back

Go Forward

Previous Page

Next Page

Navigation Links

Use the links to jump back and forth to relevant pages.

Go Back

Go Forward

Previous Page

Next Page

Navigation Links

Use the links to jump back and forth to relevant pages.

Go Back

Go Forward

Previous Page

Next Page

Haworth Price Books are organized into the following sections:

Price List Section

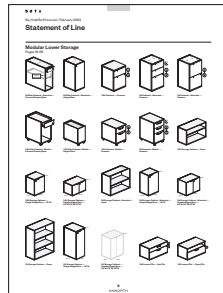

Statement of Line
Provides a visual overview of the product offering.

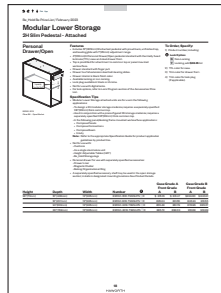

Price List
Includes product features, specification tips, catalog numbers and list pricing.

Resources Section

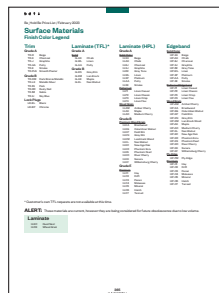

Finishes and Fabrics
Lists available product finishes and fabrics.

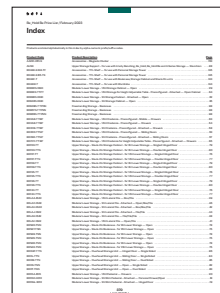

Index
Lists products alphabetically by catalog number.

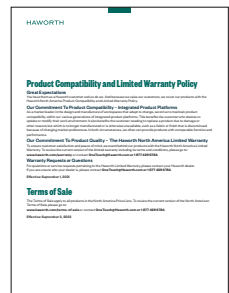

Warranty and Terms of Sale
Provides warranty information and general terms.

This Page Intentionally Left Blank

Height Adjustable Tables and Benching Price List

Includes pricing, catalog numbers, finish codes/availability, specification requirements, line art, dimensions, and specification tips for Height Adjustable Tables and Benching.

Planes Height Adjustable Tables

Bases for Planes Height Adjustable Tables

Planes LT Height Adjustable Tables

Bases for Planes LT Height Adjustable Tables

Upside Height Adjustable Tables

Bases for Upside Height Adjustable Tables

Worksurfaces for Upside Height Adjustable Tables

Planes Height Adjustable Benching

Bases for Planes Height Adjustable Benching

Planes LT Height Adjustable Benching

Bases for Planes LT Height Adjustable Benching

Bases for Upside Height Adjustable Benching

Worksurfaces for Upside Height Adjustable Benching

Accessories

Benching Electrical Components and Covers

Table of Contents

Price List

Statement of Line	7	Two-Sided Benching— Electric Adjustment	100
Planes Tables and Benching		Single-Sided Benching— Electric Adjustment	102
Catalog Logic	13	Three-Sided 120° Benching— Electric Adjustment	104
Rectangular — Incremental or Crank Adjustment	14	Upside Base for Two-Sided, Three-Sided 120° Benching	
Rectangular — Electric Adjustment	17	Catalog Logic	106
Planes Table — Corners		Upside Base for Single-Sided Benching	
Catalog Logic	20	Catalog Logic	107
90° Equal Corner — Straight — Electric Adjustment	21	Upside Base for Two-Sided Benching— Electric	108
90° Equal Corner — Wrap Around — Electric Adjustment	23	Upside Base for Single-Sided Benching— Electric	109
90° Equal Corner — Notched — Electric Adjustment	26	Upside Base for Three-Sided 120° Benching— Electric	110
90° Extended Corner — Wrap-Around — Incremental or Crank	28	Upside Worksurface for Benching — Rectangular	111
Adjustment	28	Upside Worksurface for Benching — 120° Corner — Wrap-Around	112
90° Extended Corner — Wrap-Around — Electric Adjustment	31	Upside Power and Data Channel for Benching	
90° Extended Corner — Notched — Electric Adjustment	34	For use with Single-Sided or Two-Sided Applications	113
120° Corner — Wrap-Around — Electric Adjustment	37	For use with Three-sided 120° Applications	113
Planes Bases		Data Port Bracket Kit	113
Rectangular Table — Incremental or Crank Adjustment	39	Accessories — Upside, Planes and Planes LT	
Rectangular Table — Electric Adjustment	41	Caster Kit	114
90° Equal Corner Table — Electric Adjustment	43	Collision Sensor	114
90° Extended Corner Table — Electric Adjustment	45	Benching Electrical Components and Covers —	
120° Corner Table — Electric Adjustment	47	Planes and Planes LT	
Planes LT Table		Base Feed Module — Concealed Hardwire Connection for	
Catalog Logic	48	New York City	115
Rectangular — Electric Adjustment	49	Single Circuit Base Feed – Receptacle Connection — 20 amp	115
Planes LT Table — Corners		Single Circuit Base Feed – Receptacle Connection — 15 amp	116
Catalog Logic	51	Wall Feed Field Wired 1 Port	116
90° Equal Corner — Notched — Electric Adjustment	52	Internal Power Base™ AI Base Feed	117
90° Equal Corner — Wrap-Around — Electric Adjustment	54	Infeed Harness	118
90° Extended Corner — Notched — Electric Adjustment	56	Base Feed Cover	118
90° Extended Corner — Wrap-Around — Electric Adjustment	58	Top Feed Pole, End-of-Run	119
120° Corner — Wrap-Around— Electric Adjustment	60	Top Feed Pole, Middle-of-Run	119
Planes LT Base		Utility Tray Power Retrofit Kit	120
Rectangular Table— Electric Adjustment	61	Power/Data Cover	120
90° Equal Corner Table— Electric Adjustment	63	Jumper	121
90° Extended Corner Table— Electric Adjustment	65	Transition Tray	121
120° Corner Table— Electric Adjustment	67	Transition Tray – Asymmetrical	122
Upside Table		Transition Tray — For use with Middle-of-Run, Top Feed	122
Catalog Logic	68	Transition Tray — For use with Center Screens and Middle-of-Run,	
Rectangular— Electric Adjustment	69	Top Feed	123
Upside Base		Triplex Receptacle – 15 Amp	124
Rectangular Table— Electric	71	Triplex Receptacle – 20 Amp	125
90° or 120° Table— Electric Adjustment	73	Hardwire Kit	126
Upside Worksurface for Table		Benching Electrical Components and Covers —	
Rectangular	74	Upside	
90° Equal Corner – Wrap-Around	75	Base Feed Module — Hardwire Connection for New York City	127
90° Extended Corner – Wrap-Around	76	Single Circuit Base Feed – Receptacle Connection — 20 amp	127
90° Transitional Extended Corner – Wrap-Around	78	Single Circuit Base Feed – Receptacle Connection — 15 amp	128
120° Corner – Wrap-Around	80	Wall Feed Field Wired 1 Port	128
Planes Benching		Internal Power Base™ AI Base Feed	129
Catalog Logic	81	Infeed Harness	130
Planes Two-Sided Benching — Rectangular— Electric Adjustment	82	Basefeed Cover	130
Planes Single-Sided Benching — Rectangular— Electric		Channel End Cover	131
Adjustment	85	Privacy Infill Panel Kits — Upside	131
Planes 120° Benching		Top Feed Pole, End-of-Run	132
Catalog Logic	87	Top Feed Pole, Middle-of-Run	132
Planes Three-Sided Benching — 120°— Electric Adjustment	88	Single Power Distribution Assembly (PDA)	133
Planes Base for Two-Sided Benching— Electric Adjustment	90	Double Power Distribution Assembly (PDA) Kit	134
Planes LT Benching		Jumpers	135
Catalog Logic	92	Transition Tray	136
Planes LT Two-Sided Benching — Rectangular— Electric		Triplex Receptacle – 15 Amp	137
Adjustment	93	Triplex Receptacle – 20 Amp	138
Planes Single-Sided Benching — Rectangular— Electric		Hardwire Kit	139
Adjustment	95	Fabrics and Finishes	
Planes LT Three-Sided Benching		Finish/Color Legend	377
Catalog Logic	97	Fabrics/Color Legend	380
Planes LT Three-Sided Benching — 120°— Electric Adjustment	98	Index	381
		Lifetime Product Warranty	Inside Back Cover

Statement of Line

Planes Table

Pages 14-37

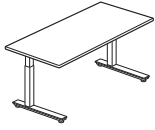

Rectangular, Incremental or Crank Adjustment

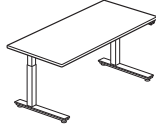

Rectangular, Electric Adjustment



90° Equal Corner — Straight, Electric Adjustment

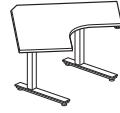

90° Equal Corner — Wrap Around, Electric Adjustment

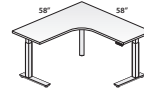

90° Equal Corner — Wrap Around, Electric Adjustment

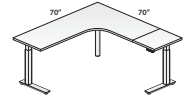

90° Equal Corner — Wrap Around, Electric Adjustment



90° Equal Corner — Notched, Electric Adjustment

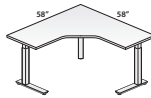

90° Equal Corner — Notched, Electric Adjustment

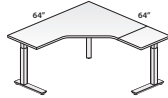

90° Equal Corner — Notched, Electric Adjustment

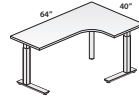

90° Extended Corner — Wrap-Around, Incremental or Crank Adjustment

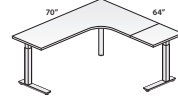

90° Extended Corner — Wrap-Around, Incremental or Crank Adjustment

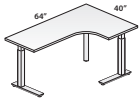

90° Extended Corner — Wrap-Around Extended, Electric Adjustment

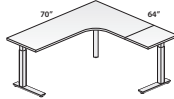

90° Extended Corner — Wrap-Around Extended, Electric Adjustment

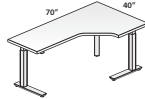

90° Extended Corner — Notched, Electric Adjustment

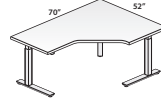

90° Extended Corner — Notched, Electric Adjustment

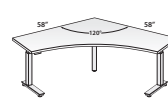

120° Corner — Wrap-Around, Electric Adjustment

Planes Base

Pages 39-47

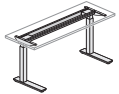

Rectangular Table, Incremental or Crank Adjustment



Rectangular Table, Electric Adjustment



90° Equal Corner Table, Electric Adjustment

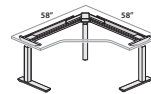

90° Equal Corner Table, Electric Adjustment

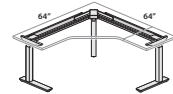

90° Equal Corner Table, Electric Adjustment

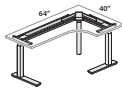

90° Extended Corner Table, Electric Adjustment

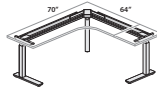

90° Extended Corner Table, Electric Adjustment



120° Corner Table, Electric Adjustment

Planes LT Table

Pages 49-60

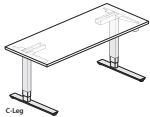

Rectangular, Electric Adjustment

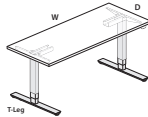

Rectangular, Electric Adjustment

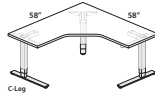

90° Equal Corner — Notched, Electric Adjustment

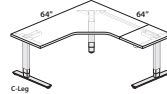

90° Equal Corner — Notched, Electric Adjustment

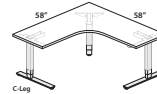

90° Equal Corner — Wrap-Around, Electric Adjustment

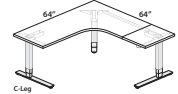

90° Equal Corner — Wrap-Around, Electric Adjustment

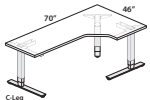

90° Extended Corner — Notched, Electric Adjustment

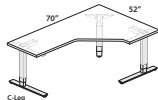

90° Extended Corner — Notched, Electric Adjustment



90° Equal Corner — Wrap-Around Extended, Electric Adjustment

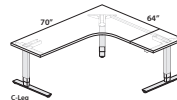

90° Equal Corner — Wrap-Around Extended, Electric Adjustment

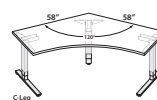

120° Corner — Wrap-Around Electric Adjustment

Statement of Line

Planes LT Base

Pages 61-67

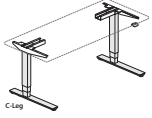

Rectangular Table, Electric Adjustment

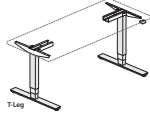

Rectangular Table, Electric Adjustment

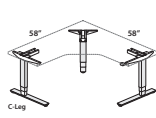

90° Equal Corner Table, Electric Adjustment

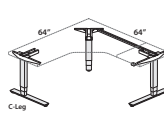

90° Equal Corner Table, Electric Adjustment

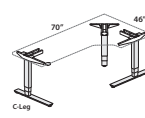

90° Extended Corner Table, Electric Adjustment

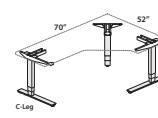

90° Extended Corner Table, Electric Adjustment

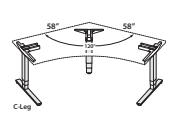

120° Corner Table, Electric Adjustment

Upside Table

Page 69

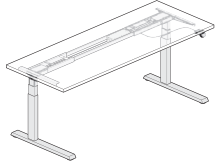

Rectangular, Electric Adjustment



Rectangular, Electric Adjustment

Upside Base

Pages 71-73

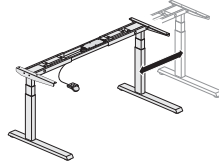

Rectangular Table, Electric

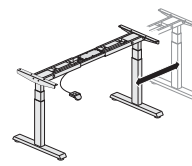

Rectangular Table, Electric

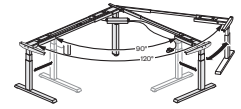

Base for 90° or 120° Table, Electric Adjustment

Upside Worksurface for Table

Page 74-80

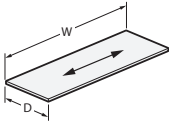

Rectangular

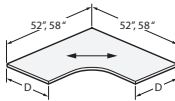

90° Equal Corner - Wrap-Around

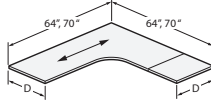

90° Equal Corner - Wrap-Around

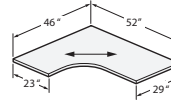

90° Extended Corner - Wrap-Around (Right-hand Orientation)

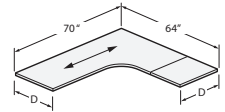

90° Extended Corner - Wrap-Around (Left-hand Orientation)

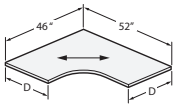

90° Transitional Extended Corner - Wrap-Around (Right-hand Orientation)

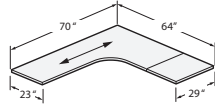

90° Transitional Extended Corner - Wrap-Around (Left-hand Orientation)

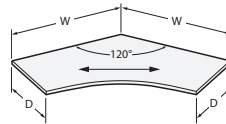

120° Corner Wrap-Around

Planes Benching

Pages 82-88

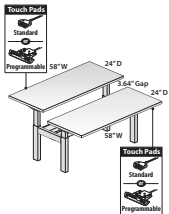

Two-Sided — Rectangular, Electric Adjustment

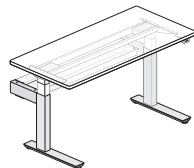

Single-Sided — Rectangular, Electric Adjustment



Three-Sided — 120°, Electric Adjustment

Statement of Line

Planes Base Benching

Page 90

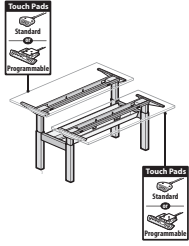

Two Sided, Electric Adjustment

Planes LT Benching

Pages 93-98

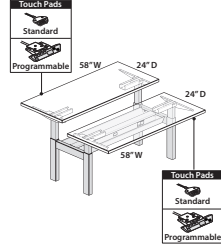

Two-Sided — Rectangular, Electric Adjustment

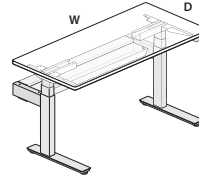

Single-Sided — Rectangular, Electric Adjustment

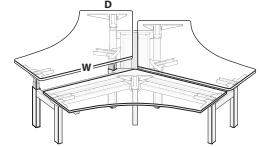

Three-Sided — 120°, Electric Adjustment

Planes LT Base Benching

Pages 100-104

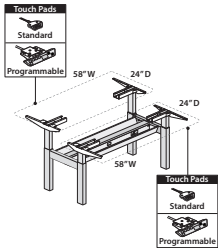

Two Sided, Electric Adjustment

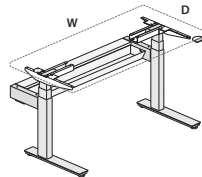

Single-Sided, Electric Adjustment

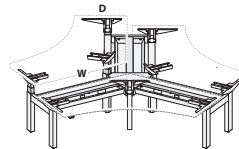

Three-Sided 120°, Electric Adjustment

Upside Base Benching

Pages 108-110

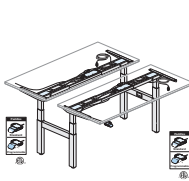

Two Sided, Electric

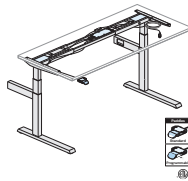

Single-Sided, Electric

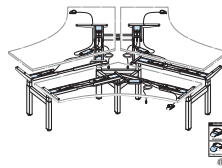

Three-Sided 120°, Electric

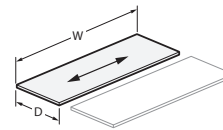

Rectangular

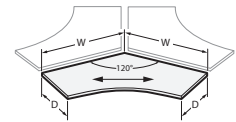

120° Corner — Wrap-Around

Upside Worksurface Benching

Pages 111-112

Upside Power and Data Channel for Benching

Page 113

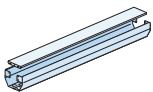

For use with Single-Sided or Two-Sided Applications

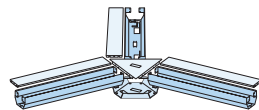

For use with Three-sided 120° Applications

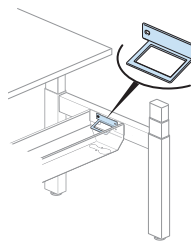

Data Port Bracket Kit

Statement of Line

Accessories — Upside, Planes and Planes LT

Pages 114

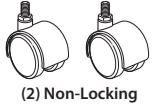

(2) Non-Locking



(2) Non-Locking

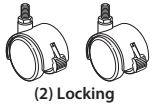

(2) Locking

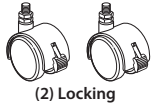

(2) Locking

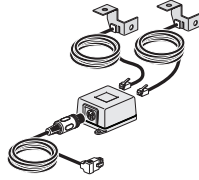

Collision Sensor

Caster Kit

Caster Kit

Benching Electrical Components and Covers — Planes and Planes LT

Pages 115-126

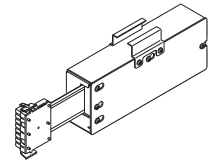

Base Feed Module — Concealed Hardwire Connection for New York City

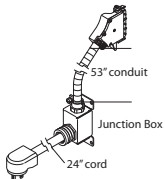

Single Circuit Base Feed — Receptacle Connection — 20 amp

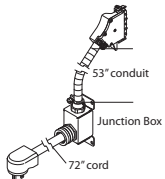

Single Circuit Base Feed — Receptacle Connection — 15 amp

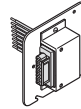

Wall Feed Field Wired 1 Port

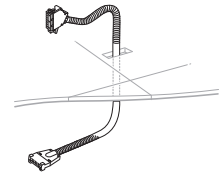

Internal Power Base™ AI Base Feed

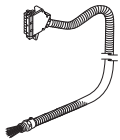

Infeed Harness

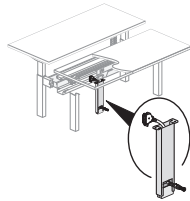

Base Feed Cover

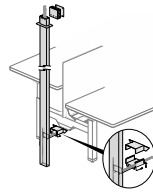

Top Feed Pole, End-of-Run

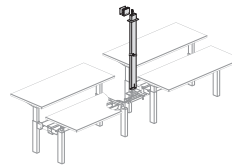

Top Feed Pole, Middle-of-Run

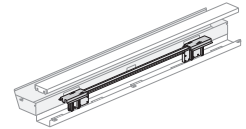

Utility Tray Power Retrofit Kit

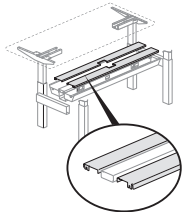

Power/Data Cover

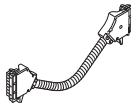

Jumper

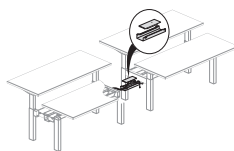

Transition Tray

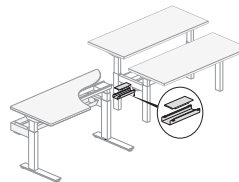

Transition Tray — Asymmetrical

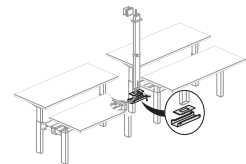

Transition Tray — For use with Middle-of-Run, Top Feed

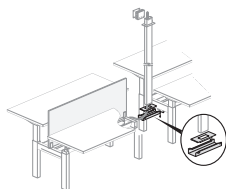

Transition Tray — For use with Center Screens and Middle-of-Run, Top Feed

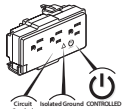

Triplex Receptacle — 15 Amp

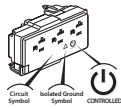

Triplex Receptacle — 20 Amp

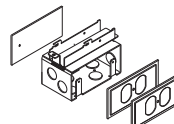
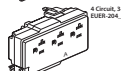
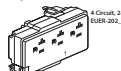
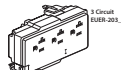
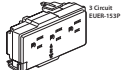

Hardwire Kit

Statement of Line

Benching Electrical Components and Covers — Upside

Pages 127-139

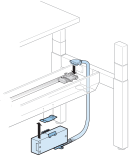

Base Feed Module — Hardwire Connection for New York City

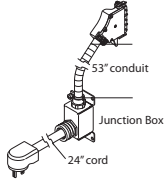

Single Circuit Base Feed — Receptacle Connection — 20 amp

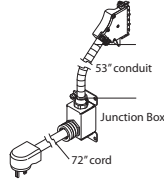

Single Circuit Base Feed — Receptacle Connection — 15 amp

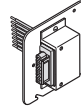

Wall Feed Field Wired 1 Port

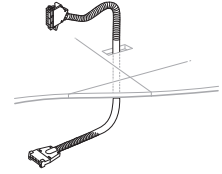

Internal Power Base™ AI Base Feed

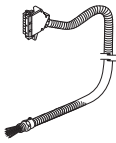

Infeed Harness

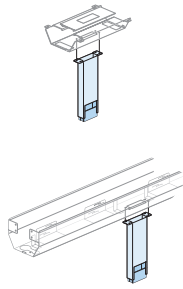

Base Feed Cover

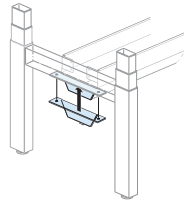

Channel End Cover

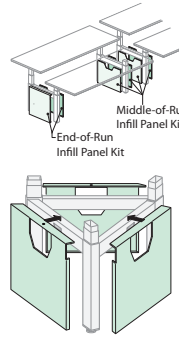

Privacy Infill Panel Kits

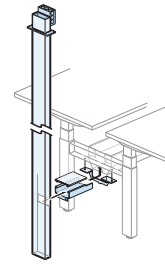

Top Feed Pole, End-of-Run

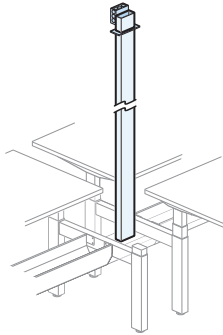

Top Feed Pole, Middle-of-Run

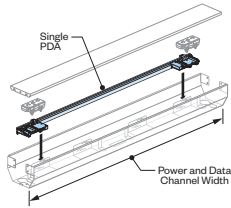

Single Power Distribution Assembly (PDA)

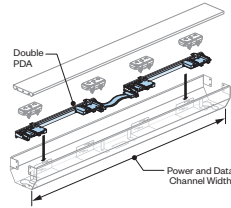

Double Power Distribution Assembly (PDA) Kit

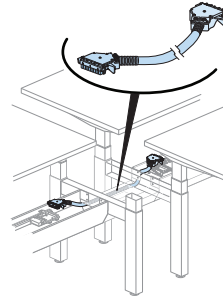

Jumpers

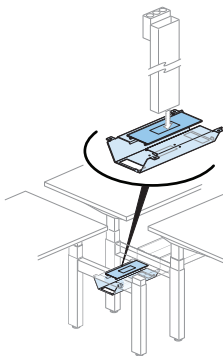

Transition Tray

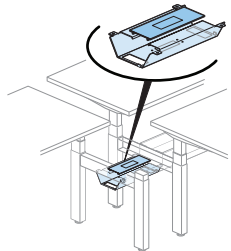

Transition Tray

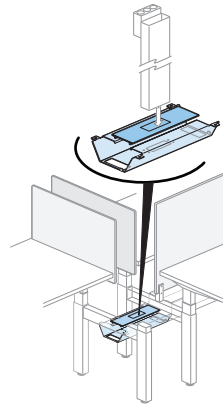

Transition Tray

Statement of Line

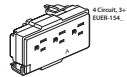
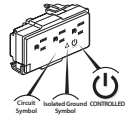

Triplex Receptacle - 15 Amp

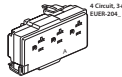
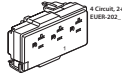
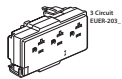
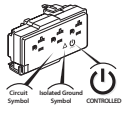

Triplex Receptacle - 20 Amp

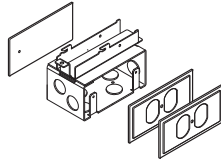

Hardwire Kit

Planes Tables and Benching

Catalog Logic

TA RA - 23 46 - L J S N C E

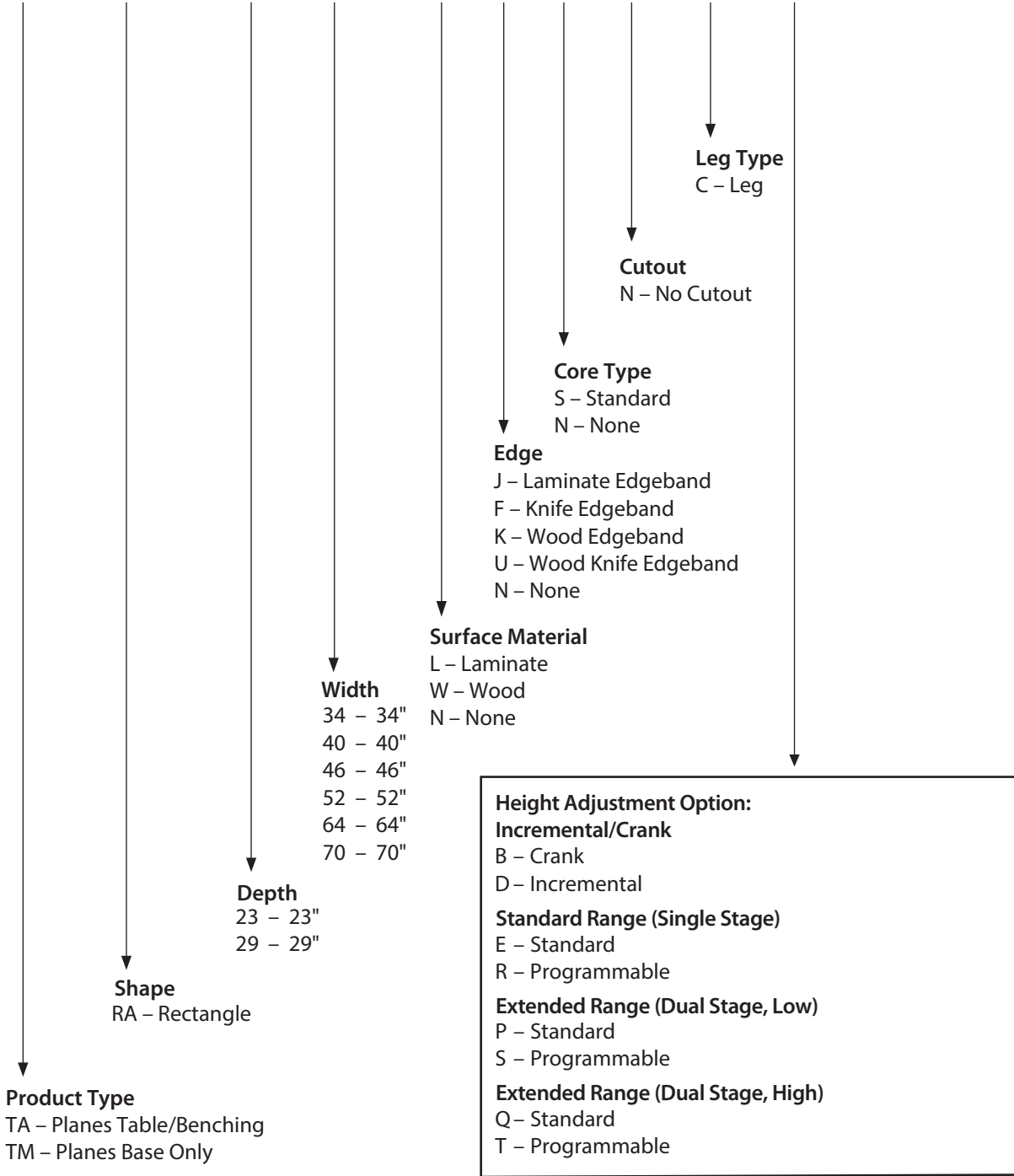

Planes Table — Rectangular

Incremental or Crank Adjustment

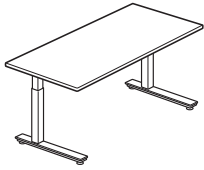

TARA
Class TA



Incremental Adjustment
Height Adjustment
22" (559mm) to
35" (889mm)

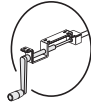

Crank Adjustment
Height Adjustment
27" (686mm) to
45" (1143mm)

**Height range includes 1.18" (20mm) work surface*

Features

- Includes:
 - 1.18"(30mm) thick work surface
 - C-leg telescoping base assembly with fixed J-Rail frame system
 - Incremental or hand crank height adjustment mechanism
 - Wire management clips
 - Adjustable glides and hardware standard in black with 0.5"(13mm) of adjustment
- Worksurface:
 - High-Pressure Laminate (HPL) with knife edge or 3mm edgeband option
 - Veneer with 3mm wood edgeband or knife edge option
 - Edgeband is 3mm on user edge and 1mm on remaining edges
- Incremental Height adjustment:
 - Telescoping columns feature 13"(330mm) of adjustment set in 1"(25mm) increments.
 - Button head screws are standard in bright zinc.
 - Thumbscrew replacement for button head screw is available; separately specified.
- Hand Crank adjustment:
 - Telescoping columns feature 18"(457mm) of adjustment.
 - 1"(25mm) of vertical movement for every 6 turns
 - Hand crank is field installed on left or right side and retracts under work surface.
- Base Assembly:
 - Telescoping inner columns default to matching or coordinating paint colors. See Finish pages for details.
 - Ships unassembled.
- Depth and width shown in nominal dimensions.

Specification Tips

- Worksurfaces are dimensioned to allow for pinch point clearance and cable accommodation; refer to Specification Guide for application guidelines when surrounded by walls, panels or other work surfaces.
- Total lifting capacity of table is 150 lbs. including surface; applied weight should be evenly distributed.
- For application guidelines with attached worktools (monitor arms, screens, storage, wire management, etc.), see Product Application guidelines.
- Separately specified caster kit available. See Specification Guide for application.

To Order, Specify:

1) Product number, including:

1 Surface Option:

L Laminate

W Wood

2 Edge Option:

Laminate:

J Edgeband

F Knife

Wood:

K Wood Edgeband

U Knife

2) Laminate surface color or wood finish color.

3) Edge trim color (laminated only).

4) Base trim color.

Note: \$63.50 upcharge list for Grade B trim colors.

Planes Table — Rectangular

Incremental or Crank Adjustment

Depth	Width	Number ①②	HPL A		HPL B		HPL E		
			J	F	J	F	J	F	
Incremental Adjustment									
23"(584mm)	34"(864mm)	TARA-2334- SNCD	\$ 1672.89	\$ 1931.22	\$ 1690.54	\$ 1948.87	\$ 1846.67	\$ 2105.00	
	40"(1016mm)	TARA-2340- SNCD	1743.62	2022.95	1764.38	2043.71	1948.06	2227.39	
	46"(1168mm)	TARA-2346- SNCD	1814.35	2114.68	1838.23	2138.56	2049.46	2349.79	
	52"(1321mm)	TARA-2352- SNCD	1885.09	2206.42	1912.08	2233.41	2150.87	2472.20	
	58"(1473mm)	TARA-2358- SNCD	1955.82	2298.15	1985.93	2328.26	2252.27	2594.60	
	64"(1626mm)	TARA-2364- SNCD	2026.55	2389.88	2059.77	2423.10	2353.66	2716.99	
	70"(1778mm)	TARA-2370- SNCD	2097.28	2481.61	2133.62	2517.95	2455.06	2839.39	
29"(737mm)	34"(864mm)	TARA-2934- SNCD	\$ 1748.01	\$ 2027.34	\$ 1770.27	\$ 2049.60	\$ 1967.13	\$ 2246.46	
	40"(1016mm)	TARA-2940- SNCD	1828.88	2129.21	1855.06	2155.39	2086.66	2386.99	
	46"(1168mm)	TARA-2946- SNCD	1909.75	2231.08	1939.86	2261.19	2206.20	2527.53	
	52"(1321mm)	TARA-2952- SNCD	1990.62	2332.95	2024.65	2366.98	2325.73	2668.06	
	58"(1473mm)	TARA-2958- SNCD	2071.50	2434.83	2109.46	2472.79	2445.27	2808.60	
	64"(1626mm)	TARA-2964- SNCD	2152.36	2536.69	2194.25	2578.58	2564.81	2949.14	
	70"(1778mm)	TARA-2970- SNCD	2233.23	2638.56	2279.05	2684.38	2684.34	3089.67	
Crank Adjustment									
23"(584mm)	34"(864mm)	TARA-2334- SNCB	\$ 2226.56	\$ 2484.89	\$ 2244.21	\$ 2502.54	\$ 2400.34	\$ 2658.67	
	40"(1016mm)	TARA-2340- SNCB	2308.37	2587.70	2329.13	2608.46	2512.81	2792.14	
	46"(1168mm)	TARA-2346- SNCB	2390.17	2690.50	2414.05	2714.38	2625.28	2925.61	
	52"(1321mm)	TARA-2352- SNCB	2471.98	2793.31	2498.97	2820.30	2737.76	3059.09	
	58"(1473mm)	TARA-2358- SNCB	2553.78	2896.11	2583.89	2926.22	2850.23	3192.56	
	64"(1626mm)	TARA-2364- SNCB	2635.59	2998.92	2668.81	3032.14	2962.70	3326.03	
	70"(1778mm)	TARA-2370- SNCB	2717.39	3101.72	2753.73	3138.06	3075.17	3459.50	
29"(737mm)	34"(864mm)	TARA-2934- SNCB	\$ 2307.21	\$ 2586.54	\$ 2329.47	\$ 2608.80	\$ 2526.33	\$ 2805.66	
	40"(1016mm)	TARA-2940- SNCB	2399.16	2699.49	2425.34	2725.67	2656.94	2957.27	
	46"(1168mm)	TARA-2946- SNCB	2491.10	2812.43	2521.21	2842.54	2787.55	3108.88	
	52"(1321mm)	TARA-2952- SNCB	2583.05	2925.38	2617.08	2959.41	2918.16	3260.49	
	58"(1473mm)	TARA-2958- SNCB	2675.00	3038.33	2712.96	3076.29	3048.77	3412.10	
	64"(1626mm)	TARA-2964- SNCB	2766.93	3151.26	2808.82	3193.15	3179.38	3563.71	
	70"(1778mm)	TARA-2970- SNCB	2858.88	3264.21	2904.70	3310.03	3309.99	3715.32	

Planes Table — Rectangular

Incremental or Crank Adjustment

Depth	Width	Number ①②	Wood A		Wood B		
			K	U	K	U	
Incremental Adjustment							
23"(584mm)	34"(864mm)	TARA-2334- SNCD	\$ 2092.41	\$ 2375.82	\$ 2105.66	\$ 2389.07	
	40"(1016mm)	TARA-2340- SNCD	2207.30	2514.35	2222.89	2529.94	
	46"(1168mm)	TARA-2346- SNCD	2322.19	2652.88	2340.12	2670.81	
	52"(1321mm)	TARA-2352- SNCD	2437.09	2791.42	2457.36	2811.69	
	58"(1473mm)	TARA-2358- SNCD	2551.98	2929.95	2574.58	2952.55	
	64"(1626mm)	TARA-2364- SNCD	2666.87	3068.48	2691.81	3093.42	
	70"(1778mm)	TARA-2370- SNCD	2781.76	3207.01	2809.04	3234.29	
29"(737mm)	34"(864mm)	TARA-2934- SNCD	\$ 2211.69	\$ 2518.74	\$ 2228.40	\$ 2535.45	
	40"(1016mm)	TARA-2940- SNCD	2336.72	2667.41	2356.38	2687.07	
	46"(1168mm)	TARA-2946- SNCD	2461.75	2816.08	2484.35	2838.68	
	52"(1321mm)	TARA-2952- SNCD	2586.78	2964.75	2612.33	2990.30	
	58"(1473mm)	TARA-2958- SNCD	2711.82	3113.43	2740.32	3141.93	
	64"(1626mm)	TARA-2964- SNCD	2836.84	3262.09	2868.29	3293.54	
	70"(1778mm)	TARA-2970- SNCD	2961.87	3410.76	2996.27	3445.16	
Crank Adjustment							
23"(584mm)	34"(864mm)	TARA-2334- SNCB	\$2646.08	\$2929.49	\$ 2659.33	\$ 2942.74	
	40"(1016mm)	TARA-2340- SNCB	2772.05	3079.10	2787.64	3094.69	
	46"(1168mm)	TARA-2346- SNCB	2898.01	3228.70	2915.94	3246.63	
	52"(1321mm)	TARA-2352- SNCB	3023.98	3378.31	3044.25	3398.58	
	58"(1473mm)	TARA-2358- SNCB	3149.94	3527.91	3172.54	3550.51	
	64"(1626mm)	TARA-2364- SNCB	3275.91	3677.52	3300.85	3702.46	
	70"(1778mm)	TARA-2370- SNCB	3401.87	3827.12	3429.15	3854.40	
29"(737mm)	34"(864mm)	TARA-2934- SNCB	\$ 2770.89	\$ 3077.94	\$ 2787.60	\$ 3094.65	
	40"(1016mm)	TARA-2940- SNCB	2907.00	3237.69	2926.66	3257.35	
	46"(1168mm)	TARA-2946- SNCB	3043.10	3397.43	3065.70	3420.03	
	52"(1321mm)	TARA-2952- SNCB	3179.21	3557.18	3204.76	3582.73	
	58"(1473mm)	TARA-2958- SNCB	3315.32	3716.93	3343.82	3745.43	
	64"(1626mm)	TARA-2964- SNCB	3451.41	3876.66	3482.86	3908.11	
	70"(1778mm)	TARA-2970- SNCB	3587.52	4036.41	3621.92	4070.81	

Planes Table — Rectangular

Electric Adjustment

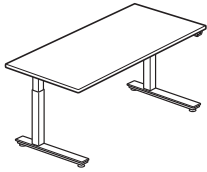

TARA
Class TA

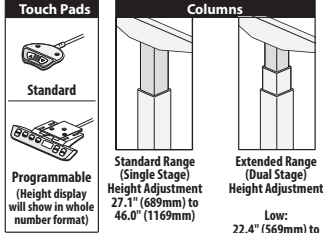

*Height range includes
1.18" (20mm) worksurface



Features

- Includes:
 - 1.18"(30mm) thick work surface
 - C-leg telescoping base assembly with fixed J-Rail frame system
 - Standard or programmable touch pad switch
 - Wire management clips
 - Adjustable glides and hardware standard in black with 0.5"(13mm) of adjustment
 - 9'(2743mm) long black power cord with NEMA 5-15P Plug to the building
- Worksurface:
 - High-Pressure Laminate (HPL) or Veneer with knife edge or 3mm edgeband option
 - 3mm Edgeband on user edge and 1mm on remaining edges
- Optional Belong Hatch cutout:
 - High-Pressure Laminate (HPL) tops only with one cutout.
 - Available on worksurfaces 29"(737mm)D and widths, 58"(1473mm), 64"(1626mm) and 70"(1778mm).
 - Requires separately specified Belong Hatch.
 - Refer to Specification Guide for cutout details.
- Electric Height Adjustment:
 - Speed: 1.4"(36mm) per second
 - Standard Range (Single Stage) telescoping columns feature 18.9"(480mm) of continuous height adjustment.
 - Extended Range (Dual Stage) telescoping columns feature a range of 25.9"(658mm) - 26.7"(678mm) of continuous adjustment.
- Base Assembly:
 - Telescoping inner columns default to matching or coordinating paint colors. See Finish pages for details.
 - Ships unassembled.
- Depth and width shown in nominal dimensions.

Specification Tips

- Worksurfaces are dimensioned to allow for pinch point clearance and cable accommodation; refer to Specification Guide for application guidelines when surrounded by walls, panels or other worksurfaces.
- Total lifting capacity of table is 250 lbs including surface; applied weight should be evenly distributed.
- For use with attached Worktools (e.g. monitor arms, screens, storage, wire management, etc.), see Product Application guidelines.
- Separately specified caster kit available.
- Application may require approval of local authority having jurisdiction (AHJ); ensure compliance before placing orders and installation.

To Order, Specify:

1) Product number, including:

1 Surface Option:

- L** Laminate
- W** Wood

2 Edge Option:

- Laminate:
- J** Edgeband
 - F** Knife

- Wood:
- K** Wood Edgeband
 - U** Knife

3 Cutout Option:

- N** Without
- H** Belong Hatch

4 Height Adjustment Actuator Options:

- Standard Range (Single Stage):
- E** Standard
 - R** Programmable (add \$202.15 list)

- Extended Range (Dual Stage, Low):
- P** Standard
 - S** Programmable (add \$202.15 list)

- (Dual Stage, High):
- Q** Standard
 - T** Programmable (add \$202.15 list)

- 2) Laminate surface color or wood finish color.
- 3) Edge trim color (laminite only).
- 4) Base trim color.

Note: \$63.50 upcharge list for Grade B trim colors.

Planes Table — Rectangular

Electric Adjustment

Depth	Width	Number ① ② ③ ④	HPL A		HPL B		HPL E	
			J	F	J	F	J	F
Standard Range (Single Stage)								
23"(584mm)	34"(864mm)	TARA-2334- <input type="checkbox"/> <input type="checkbox"/> SNC <input type="checkbox"/>	\$ 3187.26	\$3445.59	\$ 3204.91	\$3463.24	\$ 3361.04	\$ 3619.37
	40"(1016mm)	TARA-2340- <input type="checkbox"/> <input type="checkbox"/> SNC <input type="checkbox"/>	3288.28	3567.61	3309.04	3588.37	3492.72	3772.05
	46"(1168mm)	TARA-2346- <input type="checkbox"/> <input type="checkbox"/> SNC <input type="checkbox"/>	3389.30	3689.63	3413.18	3713.51	3624.41	3924.74
	52"(1321mm)	TARA-2352- <input type="checkbox"/> <input type="checkbox"/> SNC <input type="checkbox"/>	3490.32	3811.65	3517.31	3838.64	3756.10	4077.43
	58"(1473mm)	TARA-2358- <input type="checkbox"/> <input type="checkbox"/> SNC <input type="checkbox"/>	3591.34	3933.67	3621.45	3963.78	3887.79	4230.12
	64"(1626mm)	TARA-2364- <input type="checkbox"/> <input type="checkbox"/> SNC <input type="checkbox"/>	3692.36	4055.69	3725.58	4088.91	4019.47	4382.80
	70"(1778mm)	TARA-2370- <input type="checkbox"/> <input type="checkbox"/> SNC <input type="checkbox"/>	3793.38	4177.71	3829.72	4214.05	4151.16	4535.49
29"(737mm)	34"(864mm)	TARA-2934- <input type="checkbox"/> <input type="checkbox"/> SNC <input type="checkbox"/>	\$ 3277.52	\$3556.85	\$ 3299.78	\$ 3579.11	\$3496.64	\$ 3775.97
	40"(1016mm)	TARA-2940- <input type="checkbox"/> <input type="checkbox"/> SNC <input type="checkbox"/>	3388.68	3689.01	3414.86	3715.19	3646.46	3946.79
	46"(1168mm)	TARA-2946- <input type="checkbox"/> <input type="checkbox"/> SNC <input type="checkbox"/>	3499.84	3821.17	3529.95	3851.28	3796.29	4117.62
	52"(1321mm)	TARA-2952- <input type="checkbox"/> <input type="checkbox"/> SNC <input type="checkbox"/>	3611.00	3953.33	3645.03	3987.36	3946.11	4288.44
	58"(1473mm)	TARA-2958- <input type="checkbox"/> <input type="checkbox"/> S <input type="checkbox"/> C <input type="checkbox"/>	3722.16	4085.49	3760.12	4123.45	4095.93	4459.26
	64"(1626mm)	TARA-2964- <input type="checkbox"/> <input type="checkbox"/> S <input type="checkbox"/> C <input type="checkbox"/>	3833.31	4217.64	3875.20	4259.53	4245.76	4630.09
	70"(1778mm)	TARA-2970- <input type="checkbox"/> <input type="checkbox"/> S <input type="checkbox"/> C <input type="checkbox"/>	3944.47	4349.80	3990.29	4395.62	4395.58	4800.91
Extended Range (Dual Stage)								
23"(584mm)	34"(864mm)	TARA-2334- <input type="checkbox"/> <input type="checkbox"/> SNC <input type="checkbox"/>	\$4044.26	\$4302.59	\$ 4061.91	\$4320.24	\$ 4218.04	\$ 4476.37
	40"(1016mm)	TARA-2340- <input type="checkbox"/> <input type="checkbox"/> SNC <input type="checkbox"/>	4162.42	4441.75	4183.18	4462.51	4366.86	4646.19
	46"(1168mm)	TARA-2346- <input type="checkbox"/> <input type="checkbox"/> SNC <input type="checkbox"/>	4280.58	4580.91	4304.46	4604.79	4515.69	4816.02
	52"(1321mm)	TARA-2352- <input type="checkbox"/> <input type="checkbox"/> SNC <input type="checkbox"/>	4398.74	4720.07	4425.73	4747.06	4664.52	4985.85
	58"(1473mm)	TARA-2358- <input type="checkbox"/> <input type="checkbox"/> SNC <input type="checkbox"/>	4516.90	4859.23	4547.01	4889.34	4813.35	5155.68
	64"(1626mm)	TARA-2364- <input type="checkbox"/> <input type="checkbox"/> SNC <input type="checkbox"/>	4635.06	4998.39	4668.28	5031.61	4962.17	5325.50
	70"(1778mm)	TARA-2370- <input type="checkbox"/> <input type="checkbox"/> SNC <input type="checkbox"/>	4753.22	5137.55	4789.56	5173.89	5111.00	5495.33
29"(737mm)	34"(864mm)	TARA-2934- <input type="checkbox"/> <input type="checkbox"/> SNC <input type="checkbox"/>	\$ 4143.09	\$4422.42	\$ 4165.35	\$4444.68	\$ 4362.21	\$ 4641.54
	40"(1016mm)	TARA-2940- <input type="checkbox"/> <input type="checkbox"/> SNC <input type="checkbox"/>	4271.39	4571.72	4297.57	4597.90	4529.17	4829.50
	46"(1168mm)	TARA-2946- <input type="checkbox"/> <input type="checkbox"/> SNC <input type="checkbox"/>	4399.69	4721.02	4429.80	4751.13	4696.14	5017.47
	52"(1321mm)	TARA-2952- <input type="checkbox"/> <input type="checkbox"/> SNC <input type="checkbox"/>	4527.99	4870.32	4562.02	4904.35	4863.10	5205.43
	58"(1473mm)	TARA-2958- <input type="checkbox"/> <input type="checkbox"/> S <input type="checkbox"/> C <input type="checkbox"/>	4656.29	5019.62	4694.25	5057.58	5030.06	5393.39
	64"(1626mm)	TARA-2964- <input type="checkbox"/> <input type="checkbox"/> S <input type="checkbox"/> C <input type="checkbox"/>	4784.58	5168.91	4826.47	5210.80	5197.03	5581.36
	70"(1778mm)	TARA-2970- <input type="checkbox"/> <input type="checkbox"/> S <input type="checkbox"/> C <input type="checkbox"/>	4912.88	5318.21	4958.70	5364.03	5363.99	5769.32

Planes Table — Rectangular

Electric Adjustment

Depth	Width	Number ① ② ③ ④	Wood A		Wood B	
			K	U	K	U
Standard Range (Single Stage)						
23"(584mm)	34"(864mm)	TARA-2334- <input type="checkbox"/> <input type="checkbox"/> SNC <input type="checkbox"/>	\$ 3606.78	\$ 3890.19	\$3620.03	\$3903.44
	40"(1016mm)	TARA-2340- <input type="checkbox"/> <input type="checkbox"/> SNC <input type="checkbox"/>	3751.96	4059.01	3767.55	4074.60
	46"(1168mm)	TARA-2346- <input type="checkbox"/> <input type="checkbox"/> SNC <input type="checkbox"/>	3897.14	4227.83	3915.07	4245.76
	52"(1321mm)	TARA-2352- <input type="checkbox"/> <input type="checkbox"/> SNC <input type="checkbox"/>	4042.32	4396.65	4062.59	4416.92
	58"(1473mm)	TARA-2358- <input type="checkbox"/> <input type="checkbox"/> SNC <input type="checkbox"/>	4187.50	4565.47	4210.10	4588.07
	64"(1626mm)	TARA-2364- <input type="checkbox"/> <input type="checkbox"/> SNC <input type="checkbox"/>	4332.68	4734.29	4357.62	4759.23
	70"(1778mm)	TARA-2370- <input type="checkbox"/> <input type="checkbox"/> SNC <input type="checkbox"/>	4477.86	4903.11	4505.14	4930.39
29"(737mm)	34"(864mm)	TARA-2934- <input type="checkbox"/> <input type="checkbox"/> SNC <input type="checkbox"/>	\$ 3741.20	\$4048.25	\$ 3757.91	\$4064.96
	40"(1016mm)	TARA-2940- <input type="checkbox"/> <input type="checkbox"/> SNC <input type="checkbox"/>	3896.52	4227.21	3916.18	4246.87
	46"(1168mm)	TARA-2946- <input type="checkbox"/> <input type="checkbox"/> SNC <input type="checkbox"/>	4051.84	4406.17	4074.44	4428.77
	52"(1321mm)	TARA-2952- <input type="checkbox"/> <input type="checkbox"/> SNC <input type="checkbox"/>	4207.16	4585.13	4232.71	4610.68
	58"(1473mm)	TARA-2958- <input type="checkbox"/> <input type="checkbox"/> S <input type="checkbox"/> C <input type="checkbox"/>	4362.48	4764.09	4390.98	4792.59
	64"(1626mm)	TARA-2964- <input type="checkbox"/> <input type="checkbox"/> S <input type="checkbox"/> C <input type="checkbox"/>	4517.79	4943.04	4549.24	4974.49
	70"(1778mm)	TARA-2970- <input type="checkbox"/> <input type="checkbox"/> S <input type="checkbox"/> C <input type="checkbox"/>	4673.11	5122.00	4707.51	5156.40
Extended Range (Dual Stage)						
23"(584mm)	34"(864mm)	TARA-2334- <input type="checkbox"/> <input type="checkbox"/> SNC <input type="checkbox"/>	\$ 4463.78	\$ 4747.19	\$ 4477.03	\$ 4760.44
	40"(1016mm)	TARA-2340- <input type="checkbox"/> <input type="checkbox"/> SNC <input type="checkbox"/>	4626.10	4933.15	4641.69	4948.74
	46"(1168mm)	TARA-2346- <input type="checkbox"/> <input type="checkbox"/> SNC <input type="checkbox"/>	4788.42	5119.11	4806.35	5137.04
	52"(1321mm)	TARA-2352- <input type="checkbox"/> <input type="checkbox"/> SNC <input type="checkbox"/>	4950.74	5305.07	4971.01	5325.34
	58"(1473mm)	TARA-2358- <input type="checkbox"/> <input type="checkbox"/> SNC <input type="checkbox"/>	5113.06	5491.03	5135.66	5513.63
	64"(1626mm)	TARA-2364- <input type="checkbox"/> <input type="checkbox"/> SNC <input type="checkbox"/>	5275.38	5676.99	5300.32	5701.93
	70"(1778mm)	TARA-2370- <input type="checkbox"/> <input type="checkbox"/> SNC <input type="checkbox"/>	5437.70	5862.95	5464.98	5890.23
29"(737mm)	34"(864mm)	TARA-2934- <input type="checkbox"/> <input type="checkbox"/> SNC <input type="checkbox"/>	\$ 4606.77	\$ 4913.82	\$ 4623.48	\$ 4930.53
	40"(1016mm)	TARA-2940- <input type="checkbox"/> <input type="checkbox"/> SNC <input type="checkbox"/>	4779.23	5109.92	4798.89	5129.58
	46"(1168mm)	TARA-2946- <input type="checkbox"/> <input type="checkbox"/> SNC <input type="checkbox"/>	4951.69	5306.02	4974.29	5328.62
	52"(1321mm)	TARA-2952- <input type="checkbox"/> <input type="checkbox"/> SNC <input type="checkbox"/>	5124.15	5502.12	5149.70	5527.67
	58"(1473mm)	TARA-2958- <input type="checkbox"/> <input type="checkbox"/> S <input type="checkbox"/> C <input type="checkbox"/>	5296.61	5698.22	5325.11	5726.72
	64"(1626mm)	TARA-2964- <input type="checkbox"/> <input type="checkbox"/> S <input type="checkbox"/> C <input type="checkbox"/>	5469.06	5894.31	5500.51	5925.76
	70"(1778mm)	TARA-2970- <input type="checkbox"/> <input type="checkbox"/> S <input type="checkbox"/> C <input type="checkbox"/>	5641.52	6090.41	5675.92	6124.81

Planes Table — Corners

Catalog Logic

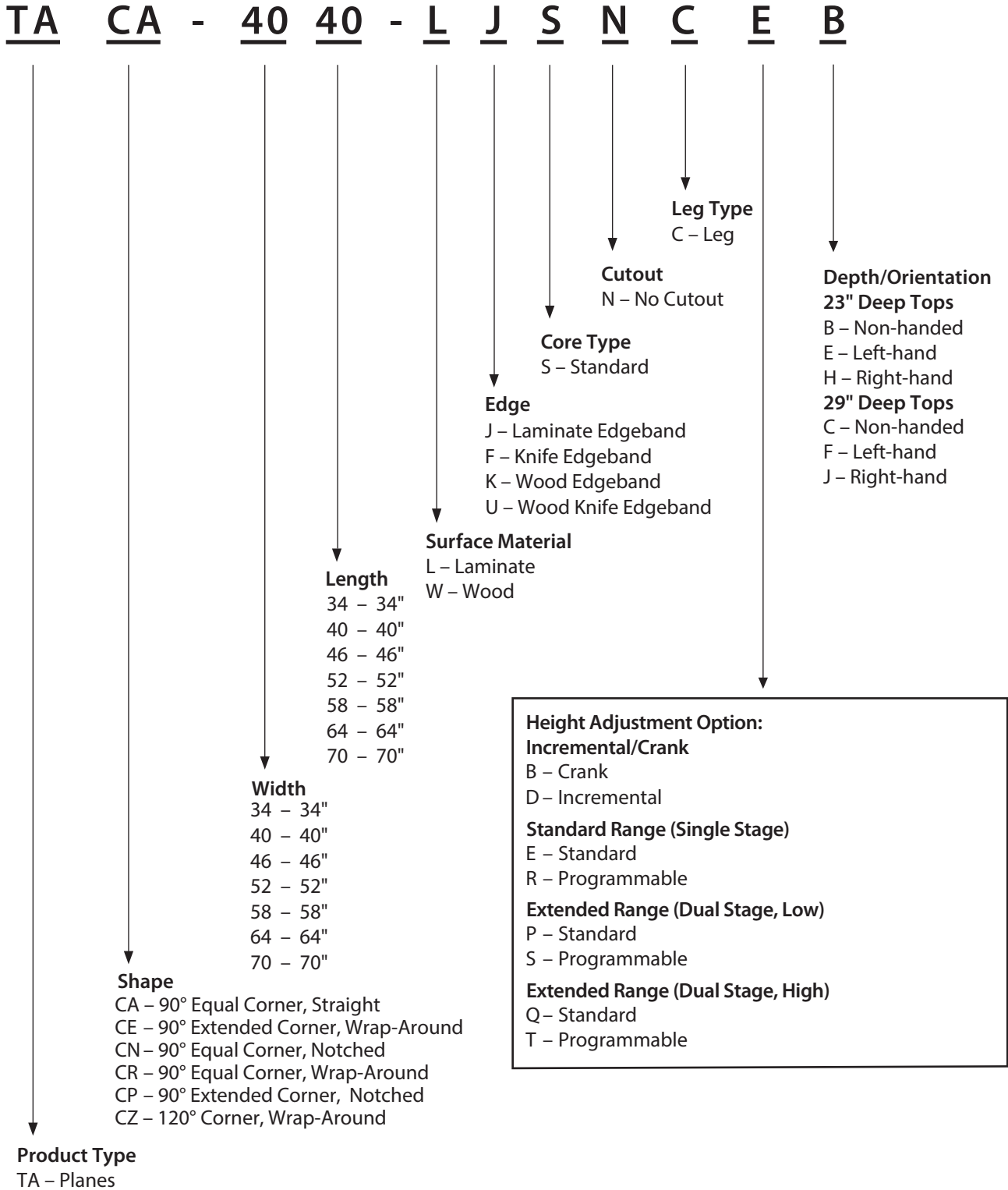

Planes Table — 90° Equal Corner — Straight

Electric Adjustment



TACA
Class TA

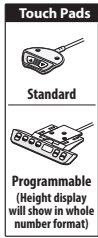

Standard
Programmable
(Height display will show in whole number format)

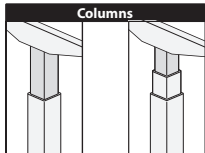

Columns
Standard Range (Single Stage)
Height Adjustment
27.1" (689mm) to
46.0" (1169mm)
Extended Range (Dual Stage)
Height Adjustment
Low:
22.4" (569mm) to
48.3" (1227mm)
High:
23.3" (592mm) to
50.0" (1270mm)

*Height range includes
1.18" (20mm) work surface



Features

- Includes:
 - 1.18"(30mm) thick work surface
 - C-leg telescoping base assembly with fixed J-Rail frame system
 - Standard or programmable touch pad switch
 - Wire management clips
 - Adjustable glides and hardware standard in black with 0.5"(13mm) of adjustment
 - 9'(2743mm) long black power cord with NEMA 5-15P Plug to the building
- Worksurface:
 - High-Pressure Laminate (HPL) or Veneer with knife edge or 3mm edgeband option
 - 3mm Edgeband on user edge and 1mm on remaining edges
- Electric Height Adjustment:
 - Speed: 1.4"(36mm) per second
 - Standard Range (Single Stage) telescoping columns feature 18.9"(480mm) of continuous height adjustment.
 - Extended Range (Dual Stage) telescoping columns feature a range of 25.9"(658mm) - 26.7"(678mm) of continuous adjustment.
- Base Assembly:
 - Telescoping inner columns default to matching or coordinating paint colors. See Finish pages for details.
 - Ships unassembled.
- Depth and width shown in nominal dimension.

Specification Tips

- Worksurfaces are dimensioned to allow for pinch point clearance and cable accommodation; refer to Specification Guide for application guidelines when surrounded by walls, panels or other worksurfaces.
- Total lifting capacity of table is 250 lbs including surface; applied weight should be evenly distributed. For use with attached Worktools (e.g. monitor arms, screens, storage, wire management, etc.), see Product Application guidelines.
- Separately specified caster kit available.
- Application may require approval of local authority having jurisdiction (AHJ); ensure compliance before placing orders and installation.

To Order, Specify:

1) Product number, including:

1 Surface Option:

- L** Laminate
- W** Wood

2 Edge Option:

Laminate:

- J** Edgeband
- F** Knife

Wood:

- K** Wood Edgeband
- U** Knife

3 Height Adjustment Actuator Options:

Standard Range
(Single Stage):

- E** Standard
- R** Programmable
(add **\$202.15** list)

Extended Range
(Dual Stage, Low):

- P** Standard
- S** Programmable
(add **\$202.15** list)

(Dual Stage, High):

- Q** Standard
- T** Programmable
(add **\$202.15** list)

2) Laminate surface color or wood finish color.

3) Edge trim color (laminated only).

4) Base trim color.

Note: \$63.50 upcharge list for Grade B trim colors.

Planes Table — 90° Equal Corner — Straight

Electric Adjustment

Left/Right Depth	Width	Number ①② ③	HPL A		HPL B	
			J	F	J	F
Standard Range (Single Stage)						
23"(584mm)/23"(584mm)	34"(864mm)	TACA-3434- SNC B	\$ 3315.19	\$3462.88	\$ 3413.49	\$ 3561.18
	40"(1016mm)	TACA-4040- SNC B	3404.02	3565.78	3511.56	3673.32
	46"(1168mm)	TACA-4646- SNC B	3513.12	3688.28	3632.21	3807.37
Extended Range (Dual Stage)						
23"(584mm)/23"(584mm)	34"(864mm)	TACA-3434- SNC B	\$ 4216.93	\$4364.62	\$ 4315.23	\$4462.92
	40"(1016mm)	TACA-4040- SNC B	4305.76	4467.52	4413.30	4575.06
	46"(1168mm)	TACA-4646- SNC B	4414.86	4590.02	4533.95	4709.11

Left/Right Depth	Width	Number ①② ③	Wood A		Wood B	
			K	U	K	U
Standard Range (Single Stage)						
23"(584mm)/23"(584mm)	34"(864mm)	TACA-3434- SNC B	\$3543.85	\$ 3742.24	\$ 3577.06	\$ 3770.25
	40"(1016mm)	TACA-4040- SNC B	3664.09	3884.74	3710.29	3924.90
	46"(1168mm)	TACA-4646- SNC B	3811.14	4052.99	3872.89	4107.90
Extended Range (Dual Stage)						
23"(584mm)/23"(584mm)	34"(864mm)	TACA-3434- SNC B	\$4445.59	\$4643.98	\$4478.80	\$ 4671.99
	40"(1016mm)	TACA-4040- SNC B	4565.83	4786.48	4612.03	4826.64
	46"(1168mm)	TACA-4646- SNC B	4712.88	4954.73	4774.63	5009.64

Planes Table — 90° Equal Corner — Wrap Around

Electric Adjustment



TACR

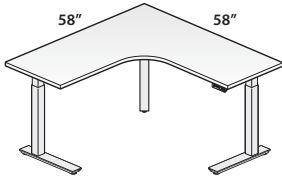

TACR-5858-NOEB

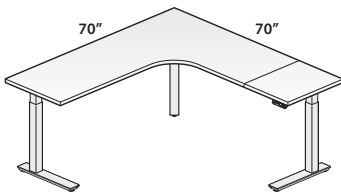

TACR-7070-NCEE
(Left-hand Orientation)
Class TA

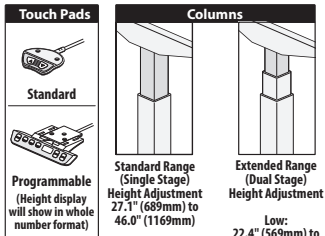

*Height range includes
1.18" (20mm) worksurface



Features

- Includes:
 - 1.18"(30mm) thick work surface
 - C-leg telescoping base assembly with fixed J-Rail frame system
 - One center post leg (with top widths 52"(1321mm) or greater)
 - Standard or programmable touch pad switch
 - Wire management clips
 - Adjustable glides and hardware standard in black with 0.5"(13mm) of adjustment
 - 9'(2743mm) long black power cord with NEMA 5-15P plug and 5'(1524mm) cable extension (with top width 52"(1321mm) or greater)
- Worksurface:
 - High-Pressure Laminate (HPL) or Veneer with knife edge or 3mm edgeband option
 - 3mm Edgeband on user edge and 1mm on remaining edges
 - Size of worksurface will determine whether top comes in 1 or 2 pieces. 64"(1626mm) wide and greater will default to 2 pieces.
 - 64"(1626mm) wide 2-piece top includes a 46"(1168mm) corner and 18"(457mm) rectangle extension.
 - 70"(1778mm) wide 2-piece top includes a 52"(1321mm) corner and 18"(457mm) rectangle extension.
- Electric Height Adjustment:
 - Speed: 1.4"(36mm) per second
 - Standard Range (Single Stage) telescoping columns feature 18.9"(480mm) of continuous height adjustment.
 - Extended Range (Dual Stage) telescoping columns feature a range of 25.9"(658mm) - 26.7"(678mm) of continuous adjustment.
- Base Assembly:
 - Telescoping inner columns default to matching or coordinating paint colors. See Finish pages for details.
 - Ships unassembled.
- Depth and width shown in nominal dimensions.

Specification Tips

- Worksurfaces are dimensioned to allow for 2"(51mm) pinch point clearance and cable accommodation. (e.g. 58"(1473mm) corner may be space-planned as a 60"(1524mm) corner for modular planning purposes.
- One-piece tops are non-handed; two-piece tops are handed.
- The "seamless" primary user side of the table (side without rectangle extension) determines the handedness from a seated position.
- Total lifting capacity of table is 250 lbs (2-leg) or 300 lbs (3-leg) including surface; applied weight should be evenly distributed.
- For use with attached Worktools (e.g. monitor arms, screens, storage, wire management, etc.), see Product Application guidelines.
- Separately specified caster kit available for 2-leg models ONLY.
- Application may require approval of local authority having jurisdiction (AHJ); ensure compliance before placing orders and installation.

To Order, Specify:

1) Product number, including:

1 Surface Option:

- L** Laminate
- W** Wood

2 Edge Option:

- Laminate:
- J** Edgeband
 - F** Knife
- Wood:
- K** Edgeband
 - U** Knife

3 Height Adjustment Actuator Options:

- Standard Range (Single Stage):
- E** Standard
 - R** Programmable (add **\$202.15** list)

- Extended Range (Dual Stage, Low):
- P** Standard
 - S** Programmable (add **\$202.15** list)

- (Dual Stage, High):
- Q** Standard
 - T** Programmable (add **\$202.15** list)

4 Depth and Orientation:

- 23" deep tops:
- E** LH (64" and 70" widths) two-piece top
 - H** RH (64" and 70" widths) two-piece top
- 29" deep tops:
- F** LH (64" and 70" widths) two-piece top
 - J** RH (64" and 70" widths) two-piece top

- 2) Laminate surface color or wood finish color.
- 3) Edge trim color (laminated only).
- 4) Base trim color.

Note: \$63.50 upcharge list for Grade B trim colors.

Planes Table — 90° Equal Corner — Wrap Around

Electric Adjustment

Left/Right Depth	Width	Leg Columns	Top Pieces	Number	①②	③④	HPL A		HPL B	
							J	F	J	F
Standard Range (Single Stage)										
23"(584mm)/23"(584mm)	34"(864mm)	2	1	TACR-3434-	SNC	B	\$ 3248.93	\$ 3309.52	\$ 3346.75	\$ 3407.34
	40"(1016mm)	2	1	TACR-4040-	SNC	B	3308.45	3369.04	3411.31	3471.90
	46"(1168mm)	2	1	TACR-4646-	SNC	B	3382.85	3443.44	3492.01	3552.60
	52"(1321mm)	3	1	TACR-5252-	SNC	B	\$ 7960.97	\$ 8021.56	\$ 8076.85	\$ 8137.44
	58"(1473mm)	3	1	TACR-5858-	SNC	B	8050.25	8110.84	8173.69	8234.28
	64"(1626mm)	3	2	TACR-6464-	SNC		8154.41	8215.00	8286.67	8347.26
	70"(1778mm)	3	2	TACR-7070-	SNC		8263.53	8324.12	8405.03	8465.62
	29"(737mm)/29"(737mm)	52"(1321mm)	3	1	TACR-5252-	SNC	C	\$ 8035.43	\$ 8096.02	\$ 8151.31
58"(1473mm)		3	1	TACR-5858-	SNC	C	8124.71	8185.30	8248.15	8308.74
64"(1626mm)		3	2	TACR-6464-	SNC		8228.87	8289.46	8361.13	8421.72
70"(1778mm)		3	2	TACR-7070-	SNC		8337.99	8398.58	8479.49	8540.08
Extended Range (Dual Stage)										
23"(584mm)/23"(584mm)	34"(864mm)	2	1	TACR-3434-	SNC	B	\$ 4153.04	\$ 4213.63	\$ 4250.86	\$ 4311.45
	40"(1016mm)	2	1	TACR-4040-	SNC	B	4212.56	4273.15	4315.42	4376.01
	46"(1168mm)	2	1	TACR-4646-	SNC	B	4286.96	4347.55	4396.12	4456.71
	52"(1321mm)	3	1	TACR-5252-	SNC	B	\$ 10652.15	\$ 10712.74	\$10768.03	\$ 10828.62
	58"(1473mm)	3	1	TACR-5858-	SNC	B	10741.43	10802.02	10864.87	10925.46
	64"(1626mm)	3	2	TACR-6464-	SNC		10845.59	10906.18	10977.85	11038.44
	70"(1778mm)	3	2	TACR-7070-	SNC		10954.71	11015.30	11096.21	11156.80
29"(737mm)/29"(737mm)	52"(1321mm)	3	1	TACR-5252-	SNC	C	\$ 10726.61	\$ 10787.20	\$10842.49	\$10903.08
	58"(1473mm)	3	1	TACR-5858-	SNC	C	10815.89	10876.48	10939.33	10999.92
	64"(1626mm)	3	2	TACR-6464-	SNC		10920.05	10980.64	11052.31	11112.90
	70"(1778mm)	3	2	TACR-7070-	SNC		11029.17	11089.76	11170.67	11231.26

Planes Table — 90° Equal Corner — Wrap Around

Electric Adjustment

Left/Right Depth	Width	Leg Columns	Top Pieces	Number	①②	③④	Wood A		Wood B	
							K	U	K	U
Standard Range (Single Stage)										
23"(584mm)/23"(584mm)	34"(864mm)	2	1	TACR-3434-	SNC	B	\$ 3332.79	\$ 3393.38	\$ 3337.84	\$ 3398.43
	40"(1016mm)	2	1	TACR-4040-	SNC	B	3391.83	3452.42	3400.96	3461.55
	46"(1168mm)	2	1	TACR-4646-	SNC	B	3465.63	3526.22	3479.86	3540.45
	52"(1321mm)	3	1	TACR-5252-	SNC	B	\$ 8043.11	\$ 8103.70	\$ 8062.78	\$ 8123.37
	58"(1473mm)	3	1	TACR-5858-	SNC	B	8131.67	8192.26	8157.46	8218.05
	64"(1626mm)	3	2	TACR-6464-	SNC		8234.99	8295.58	8267.92	8328.51
	70"(1778mm)	3	2	TACR-7070-	SNC		8343.23	8403.82	8383.64	8444.23
	29"(737mm)/29"(737mm)	3	1	TACR-5252-	SNC	C	\$ 8117.57	\$ 8178.16	\$ 8137.24	\$ 8197.83
	58"(1473mm)	3	1	TACR-5858-	SNC	C	8206.13	8266.72	8231.92	8292.51
	64"(1626mm)	3	2	TACR-6464-	SNC		8309.45	8370.04	8342.38	8402.97
	70"(1778mm)	3	2	TACR-7070-	SNC		8417.69	8478.28	8458.10	8518.69
	Extended Range (Dual Stage)									
23"(584mm)/23"(584mm)	34"(864mm)	2	1	TACR-3434-	SNC	B	\$ 4236.90	\$ 4297.49	\$ 4241.95	\$ 4302.54
	40"(1016mm)	2	1	TACR-4040-	SNC	B	4295.94	4356.53	4305.07	4365.66
	46"(1168mm)	2	1	TACR-4646-	SNC	B	4369.74	4430.33	4383.97	4444.56
	52"(1321mm)	3	1	TACR-5252-	SNC	B	\$10734.29	\$10794.88	\$10753.96	\$ 10814.55
	58"(1473mm)	3	1	TACR-5858-	SNC	B	10822.85	10883.44	10848.64	10909.23
	64"(1626mm)	3	2	TACR-6464-	SNC		10926.17	10986.76	10959.10	11019.69
	70"(1778mm)	3	2	TACR-7070-	SNC		11034.41	11095.00	11074.82	11135.41
	29"(737mm)/29"(737mm)	3	1	TACR-5252-	SNC	C	\$10808.75	\$10869.34	\$10828.42	\$ 10889.01
	58"(1473mm)	3	1	TACR-5858-	SNC	C	10897.31	10957.90	10923.10	10983.69
	64"(1626mm)	3	2	TACR-6464-	SNC		11000.63	11061.22	11033.56	11094.15
	70"(1778mm)	3	2	TACR-7070-	SNC		11108.87	11169.46	11149.28	11209.87

Planes Table — 90° Equal Corner — Notched

Electric Adjustment

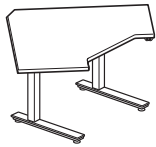

TACN

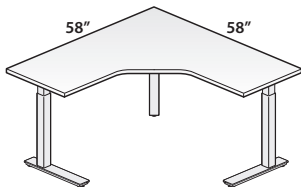

TACN-5858-NOEB

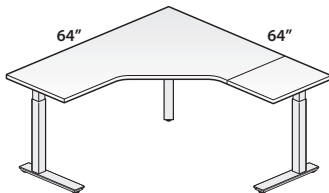

TACN-6464-NOEE
(Left-hand Orientation)
Class TA

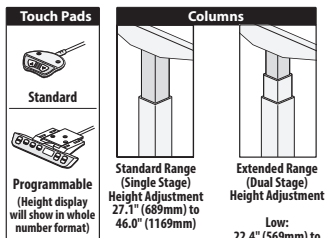

*Height range includes 1.18" (20mm) work surface



Features

- Includes:
 - 1.18"(30mm) thick work surface
 - C-leg telescoping base assembly with fixed J-Rail frame system
 - One center post leg (with top widths 52"(1321mm) or greater)
 - Standard or programmable touch pad switch
 - Wire management clips
 - Adjustable glides and hardware standard in black with 0.5"(13mm) of adjustment
 - 9'(2743mm) long black power cord with NEMA 5-15P plug and 5'(1524mm) cable extension (with top width 52"(1321mm) or greater)
- Worksurface:
 - High-Pressure Laminate (HPL) or Veneer with knife edge or 3mm edgeband option
 - 3mm Edgeband on user edge and 1mm on remaining edges
 - Size of worksurface will determine whether top comes in 1 or 2 pieces. 64"(1626mm) wide and greater will default to 2 pieces.
 - 64"(1626mm) wide 2-piece top includes a 46"(1168mm) corner and 18"(457mm) rectangle extension.
 - 70"(1778mm) wide 2-piece top includes a 52"(1321mm) corner and 18"(457mm) rectangle extension.
- Electric Height Adjustment:
 - Speed: 1.4"(36mm) per second
 - Standard Range (Single Stage) telescoping columns feature 18.9"(480mm) of continuous height adjustment.
 - Extended Range (Dual Stage) telescoping columns feature a range of 25.9"(658mm) - 26.7"(678mm) of continuous adjustment.
- Base Assembly:
 - Telescoping inner columns default to matching or coordinating paint colors. See Finish pages for details.
 - Ships unassembled.
- Depth and width shown in nominal dimensions.

Specification Tips

- Worksurfaces are dimensioned to allow for 2"(51mm) pinch point clearance and cable accommodation. (e.g. 58"(1473mm) corner may be space planned as a 60"(1524mm) corner for modular planning purposes.
- One-piece tops are non-handed; two-piece tops are handed.
- The "seamless" primary user side of the table (side without rectangle extension) determines the handedness from a seated position.
- Total lifting capacity of table is 250 lbs (2-leg) or 300 lbs (3-leg) including surface; applied weight should be evenly distributed.
- For use with attached Worktools (e.g. monitor arms, screens, storage, wire management, etc.), see Product Application guidelines.
- Separately specified caster kit available for 2-leg models ONLY.
- Application may require approval of local authority having jurisdiction (AHJ); ensure compliance before placing orders and installation.

To Order, Specify:

1) Product number, including:

1 Surface Option:

- L** Laminate
- W** Wood

2 Edge Option:

- Laminate:
- J** Edgeband
 - F** Knife

- Wood:
- K** Edgeband
 - U** Knife

3 Height Adjustment Actuator Options:

- Standard Range (Single Stage):
- E** Standard
 - R** Programmable (add **\$202.15** list)

- Extended Range (Dual Stage, Low):
- P** Standard
 - S** Programmable (add **\$202.15** list)

- (Dual Stage, High):
- Q** Standard
 - T** Programmable (add **\$202.15** list)

4 Depth and Orientation:

- 23" deep tops:
- E** LH (64" and 70" widths) two-piece top
 - H** RH (64" and 70" widths) two-piece top
- 29" deep tops:
- F** LH (64" and 70" widths) two-piece top
 - J** RH (64" and 70" widths) two-piece top

- 2) Laminate surface color or wood finish color.
- 3) Edge trim color (laminated only).
- 4) Base trim color.

Note: \$63.50 upcharge list for Grade B trim colors.

Planes Table — 90° Equal Corner — Notched

Electric Adjustment

Left/Right Depth	Width	Leg Columns	Top Pieces	Number	①②	③④	HPL A		HPL B	
							J	F	J	F
Standard Range (Single Stage)										
23"(584mm)/23"(584mm)	34"(864mm)	2	1	TACN-3434-	SNC	B	\$ 3300.02	\$3602.52	\$3300.02	\$3602.52
	40"(1016mm)	2	1	TACN-4040-	SNC	B	3394.29	3723.68	3416.02	3723.68
	46"(1168mm)	2	1	TACN-4646-	SNC	B	3488.56	3844.84	3532.02	3844.84
	52"(1321mm)	3	1	TACN-5252-	SNC	B	\$ 8081.59	\$8464.76	\$ 8146.78	\$8464.76
	58"(1473mm)	3	1	TACN-5858-	SNC	B	8175.86	8585.92	8262.78	8585.92
	64"(1626mm)	3	2	TACN-6464-	SNC		8270.13	8707.08	8378.78	8707.08
	70"(1778mm)	3	2	TACN-7070-	SNC		8364.40	8828.24	8494.78	8828.24
29"(737mm)/29"(737mm)	52"(1321mm)	3	1	TACN-5252-	SNC	C	\$ 8156.05	\$8539.22	\$ 8221.24	\$8539.22
	58"(1473mm)	3	1	TACN-5858-	SNC	C	8250.32	8660.38	8337.24	8660.38
	64"(1626mm)	3	2	TACN-6464-	SNC		8344.59	8781.54	8453.24	8781.54
	70"(1778mm)	3	2	TACN-7070-	SNC		8438.86	8902.70	8569.24	8902.70
Extended Range (Dual Stage)										
23"(584mm)/23"(584mm)	34"(864mm)	2	1	TACN-3434-	SNC	B	\$ 4210.98	\$ 4513.48	\$ 4210.98	\$ 4513.48
	40"(1016mm)	2	1	TACN-4040-	SNC	B	4305.25	4634.64	4326.98	4634.64
	46"(1168mm)	2	1	TACN-4646-	SNC	B	4399.52	4755.80	4442.98	4755.80
	52"(1321mm)	3	1	TACN-5252-	SNC	B	\$10779.62	\$ 1162.79	\$10844.81	\$ 1162.79
	58"(1473mm)	3	1	TACN-5858-	SNC	B	10873.89	11283.95	10960.81	11283.95
	64"(1626mm)	3	2	TACN-6464-	SNC		10968.16	11405.11	11076.81	11405.11
	70"(1778mm)	3	2	TACN-7070-	SNC		11062.43	11526.27	11192.81	11526.27
29"(737mm)/29"(737mm)	52"(1321mm)	3	1	TACN-5252-	SNC	C	\$10854.08	\$ 11237.25	\$10919.27	\$ 11237.25
	58"(1473mm)	3	1	TACN-5858-	SNC	C	10948.35	11358.41	11035.27	11358.41
	64"(1626mm)	3	2	TACN-6464-	SNC		11042.62	11479.57	11151.27	11479.57
	70"(1778mm)	3	2	TACN-7070-	SNC		11136.89	11600.73	11267.27	11600.73

Left/Right Depth	Width	Leg Columns	Top Pieces	Number	①②	③④	Wood A		Wood B	
							K	U	K	U
Standard Range (Single Stage)										
23"(584mm)/23"(584mm)	34"(864mm)	2	1	TACN-3434-	SNC	B	\$ 3528.23	\$ 3588.82	\$ 3544.51	\$ 3605.10
	40"(1016mm)	2	1	TACN-4040-	SNC	B	3677.45	3866.80	3702.49	3891.84
	46"(1168mm)	2	1	TACN-4646-	SNC	B	3826.67	4144.78	3860.47	4178.58
	52"(1321mm)	3	1	TACN-5252-	SNC	B	\$ 8474.65	\$ 8921.52	\$ 8517.21	\$ 8964.08
	58"(1473mm)	3	1	TACN-5858-	SNC	B	8623.87	9199.50	8675.19	9250.82
	64"(1626mm)	3	2	TACN-6464-	SNC		8773.09	9477.48	8833.17	9537.56
	70"(1778mm)	3	2	TACN-7070-	SNC		8922.31	9755.46	8991.15	9824.30
29"(737mm)/29"(737mm)	52"(1321mm)	3	1	TACN-5252-	SNC	C	\$ 8549.11	\$ 8995.98	\$ 8591.67	\$ 9038.54
	58"(1473mm)	3	1	TACN-5858-	SNC	C	8698.33	9273.96	8749.65	9325.28
	64"(1626mm)	3	2	TACN-6464-	SNC		8847.55	9551.94	8907.63	9612.02
	70"(1778mm)	3	2	TACN-7070-	SNC		8996.77	9829.92	9065.61	9898.76
Extended Range (Dual Stage)										
23"(584mm)/23"(584mm)	34"(864mm)	2	1	TACN-3434-	SNC	B	\$ 4439.19	\$ 4499.78	\$ 4455.47	\$ 4516.06
	40"(1016mm)	2	1	TACN-4040-	SNC	B	4588.41	4777.76	4613.45	4802.80
	46"(1168mm)	2	1	TACN-4646-	SNC	B	4737.63	5055.74	4771.43	5089.54
	52"(1321mm)	3	1	TACN-5252-	SNC	B	\$ 11172.68	\$ 11619.55	\$ 11215.24	\$ 11662.11
	58"(1473mm)	3	1	TACN-5858-	SNC	B	11321.90	11897.53	11373.22	11948.85
	64"(1626mm)	3	2	TACN-6464-	SNC		11471.12	12175.51	11531.20	12235.59
	70"(1778mm)	3	2	TACN-7070-	SNC		11620.34	12453.49	11689.18	12522.33
29"(737mm)/29"(737mm)	52"(1321mm)	3	1	TACN-5252-	SNC	C	\$ 11247.14	\$ 11694.01	\$ 11289.70	\$ 11736.57
	58"(1473mm)	3	1	TACN-5858-	SNC	C	11396.36	11971.99	11447.68	12023.31
	64"(1626mm)	3	2	TACN-6464-	SNC		11545.58	12249.97	11605.66	12310.05
	70"(1778mm)	3	2	TACN-7070-	SNC		11694.80	12527.95	11763.64	12596.79

Planes Table — 90° Extended Corner — Wrap-Around Incremental or Crank Adjustment

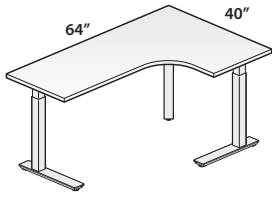

TACE-4064-NCDB
(Left-hand Orientation)

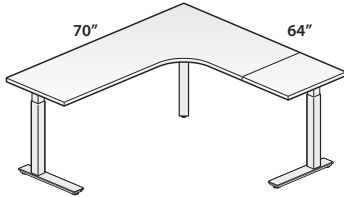

TACE-6470-NCDE
(Left-hand Orientation)
Class TA



Incremental Adjustment
Height Adjustment
22" (559mm) to
35" (889mm)

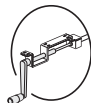

Crank Adjustment
Height Adjustment
27" (686mm) to
45" (1143mm)

*Height range includes 1.18" (20mm) work surface

Features

- Includes:
 - 1.18"(30mm) thick work surface
 - C-leg telescoping base assembly with fixed J-Rail frame system
 - One center post leg
 - Standard or programmable touch pad switch
 - Wire management clips
 - Adjustable glides and hardware standard in black with 0.5"(13mm) of adjustment
- Worksurface:
 - High-Pressure Laminate (HPL) or Veneer with knife edge or 3mm edgeband option
 - 3mm Edgeband on user edge and 1mm on remaining edges
 - Top sizes 64x70 and larger will default to 2-pieces.
 - A 64"(1626mm) x 70"(1778mm) worksurface will include a 46"(1168mm) corner and 18"(457mm) rectangle extension.
- Incremental Height adjustment:
 - Telescoping columns feature 13"(330mm) of adjustment set in 1"(25mm) increments.
 - Button head screws are standard in bright zinc.
 - Thumbscrew replacement for button head screw is available; separately specified.
- Hand Crank adjustment:
 - Telescoping columns feature 18"(457mm) of adjustment.
 - 1"(25mm) of vertical movement for every 6 turns
 - Hand crank is field installed on left or right side and retracts under worksurface.
- Base Assembly:
 - Telescoping inner columns default to matching or coordinating paint colors. See Finish pages for details.
 - Ships unassembled.
- Depth and Width shown in nominal dimensions.

Specification Tips

- Worksurfaces are dimensioned to allow for pinch point clearance and cable accommodation; refer to Specification Guide for application guidelines when surrounded by walls, panels or other worksurfaces.
- User orientation or "handedness" is determined by longest side of worksurface from seated position.
- Total lifting capacity of table is 200 lbs including surface; applied weight should be evenly distributed.
- For application guidelines with attached Worktools (monitor arms, screens, storage, wire management, etc.), see Product Application guidelines.
- Not designed for use with Casters.

To Order, Specify:

1) Product number, including:

1 Surface Options:

L Laminate

W Wood

2 Edge Options:

Laminate:

J Edgeband

F Knife

Wood:

K Edgeband

U Knife

3 Depth and Orientation:

23" deep tops:

E Left-hand

H Right-hand

29" deep tops:

F Left-hand

J Right-hand

2) Laminate surface color or wood finish color.

3) Edge trim color (laminate only).

4) Base trim color.

Note: \$63.50 upcharge list for Grade B trim colors.

Planes Table — 90° Extended Corner — Wrap-Around Incremental or Crank Adjustment

Left/Right Depth	Width	Length	Top Pieces	Number	①	②	HPL A		HPL B		
							J	F	J	F	
Incremental Adjustment											
23"(584mm)/23"(584mm)	40"(1016mm)	46"(1168mm)	1	TACE-4046-	SNCD		\$ 3767.26	\$ 4118.49	\$ 3868.51	\$ 4219.74	
		52"(1321mm)	1	TACE-4052-	SNCD		3805.22	4184.13	3909.13	4288.04	
		58"(1473mm)	1	TACE-4058-	SNCD		3838.13	4242.99	3944.32	4349.18	
		64"(1626mm)	1	TACE-4064-	SNCD		3875.80	4306.61	3984.65	4415.46	
	46"(1168mm)	52"(1321mm)	1	TACE-4652-	SNCD		\$3845.04	\$ 4234.33	\$ 3951.99	\$ 4341.28	
		58"(1473mm)	1	TACE-4658-	SNCD		3887.47	4302.71	3997.46	4412.70	
		64"(1626mm)	1	TACE-4664-	SNCD		3929.90	4371.09	4042.93	4484.12	
		70"(1778mm)	1	TACE-4670-	SNCD		3967.86	4436.73	4083.55	4552.42	
	52"(1321mm)	64"(1626mm)	1	TACE-5264-	SNCD		\$ 3979.24	\$ 4430.81	\$4096.07	\$ 4547.64	
		70"(1778mm)	1	TACE-5270-	SNCD		4026.72	4505.97	4146.97	4626.22	
		58"(1473mm)	64"(1626mm)	1	TACE-5864-	SNCD		\$4033.34	\$4495.29	\$ 4154.35	\$ 4616.30
			70"(1778mm)	1	TACE-5870-	SNCD		4085.58	4575.21	4210.39	4700.02
	64"(1626mm)	70"(1778mm)	2	TACE-6470-	SNCD		\$ 4139.68	\$4639.69	\$ 4268.67	\$ 4768.68	
	29"(737mm)/29"(737mm)	46"(1168mm)	52"(1321mm)	1	TACE-4652-	SNCD		\$ 3917.14	\$4309.89	\$4024.09	\$ 4416.84
			58"(1473mm)	1	TACE-4658-	SNCD		3959.86	4380.29	4069.85	4490.28
64"(1626mm)			1	TACE-4664-	SNCD		4002.29	4448.67	4115.32	4561.70	
70"(1778mm)			1	TACE-4670-	SNCD		4039.96	4512.29	4155.65	4627.98	
52"(1321mm)		64"(1626mm)	1	TACE-5264-	SNCD		\$ 4051.63	\$4508.39	\$ 4168.46	\$ 4625.22	
		70"(1778mm)	1	TACE-5270-	SNCD		4098.82	4581.53	4219.07	4701.78	
		58"(1473mm)	64"(1626mm)	1	TACE-5864-	SNCD		\$ 4105.73	\$ 4572.87	\$ 4226.74	\$ 4693.88
			70"(1778mm)	1	TACE-5870-	SNCD		4157.68	4650.77	4282.49	4775.58
64"(1626mm)		70"(1778mm)	2	TACE-6470-	SNCD		\$ 4211.78	\$ 4715.25	\$ 4340.77	\$ 4844.24	
Crank Adjustment											
23"(584mm)/23"(584mm)		40"(1016mm)	52"(1321mm)	1	TACE-4052-	SNCB		\$ 4256.68	\$4635.59	\$4360.59	\$ 4739.50
			58"(1473mm)	1	TACE-4058-	SNCB		4289.59	4694.45	4395.78	4800.64
			64"(1626mm)	1	TACE-4064-	SNCB		4327.26	4758.07	4436.11	4866.92
		46"(1168mm)	52"(1321mm)	1	TACE-4652-	SNCB		\$4296.50	\$4685.79	\$4403.45	\$ 4792.74
			58"(1473mm)	1	TACE-4658-	SNCB		4338.93	4754.17	4448.92	4864.16
			64"(1626mm)	1	TACE-4664-	SNCB		4381.36	4822.55	4494.39	4935.58
	70"(1778mm)		1	TACE-4670-	SNCB		4419.32	4888.19	4535.01	5003.88	
	52"(1321mm)	64"(1626mm)	1	TACE-5264-	SNCB		\$4430.70	\$4882.27	\$ 4547.53	\$ 4999.10	
		70"(1778mm)	1	TACE-5270-	SNCB		4478.18	4957.43	4598.43	5077.68	
		58"(1473mm)	64"(1626mm)	1	TACE-5864-	SNCB		\$4484.80	\$4946.75	\$ 4605.81	\$ 5067.76
			70"(1778mm)	1	TACE-5870-	SNCB		4537.04	5026.67	4661.85	5151.48
	64"(1626mm)	70"(1778mm)	2	TACE-6470-	SNCB		\$ 4591.14	\$ 5091.15	\$ 4720.13	\$ 5220.14	
	29"(737mm)/29"(737mm)	46"(1168mm)	52"(1321mm)	1	TACE-4652-	SNCB		\$4368.60	\$ 4761.35	\$ 4475.55	\$ 4868.30
			58"(1473mm)	1	TACE-4658-	SNCB		4411.32	4831.75	4521.31	4941.74
			64"(1626mm)	1	TACE-4664-	SNCB		4453.75	4900.13	4566.78	5013.16
			70"(1778mm)	1	TACE-4670-	SNCB		4491.42	4963.75	4607.11	5079.44
52"(1321mm)		64"(1626mm)	1	TACE-5264-	SNCB		\$4503.09	\$4959.85	\$ 4619.92	\$ 5076.68	
		70"(1778mm)	1	TACE-5270-	SNCB		4550.28	5032.99	4670.53	5153.24	
		58"(1473mm)	64"(1626mm)	1	TACE-5864-	SNCB		\$ 4557.19	\$5024.33	\$4678.20	\$ 5145.34
			70"(1778mm)	1	TACE-5870-	SNCB		4609.14	5102.23	4733.95	5227.04
64"(1626mm)		70"(1778mm)	2	TACE-6470-	SNCB		\$4663.24	\$ 5166.71	\$ 4792.23	\$ 5295.70	

Planes Table — 90° Extended Corner — Wrap-Around Incremental or Crank Adjustment

Left/Right Depth	Width	Length	Top Pieces	Number	①	②	Wood A		Wood B		
							K	U	K	U	
Incremental Adjustment											
23"(584mm)/23"(584mm)	40"(1016mm)	46"(1168mm)	1	TACE-4046-	SNCD		\$ 4086.21	\$ 4640.72	\$ 4096.97	\$ 4680.04	
		52"(1321mm)	1	TACE-4052-	SNCD		4119.39	4720.94	4132.39	4765.22	
		58"(1473mm)	1	TACE-4058-	SNCD		4147.83	4793.48	4162.75	4842.23	
		64"(1626mm)	1	TACE-4064-	SNCD		4181.01	4870.76	4198.17	4924.30	
46"(1168mm)	52"(1321mm)	58"(1473mm)	1	TACE-4652-	SNCD	\$	4157.31	\$ 4776.50	\$ 4172.87	\$ 4824.36	
		64"(1626mm)	1	TACE-4658-	SNCD		4195.23	4858.52	4213.35	4911.49	
		70"(1778mm)	1	TACE-4664-	SNCD		4233.15	4940.54	4253.83	4998.62	
		70"(1778mm)	1	TACE-4670-	SNCD		4266.33	5020.76	4289.25	5083.80	
52"(1321mm)	64"(1626mm)	70"(1778mm)	1	TACE-5264-	SNCD	\$	4280.55	\$ 5005.58	\$ 4304.43	\$ 5067.88	
		70"(1778mm)	1	TACE-5270-	SNCD		4323.21	5095.28	4349.97	5163.18	
58"(1473mm)	64"(1626mm)	70"(1778mm)	1	TACE-5864-	SNCD	\$	4332.69	\$ 5075.36	\$ 4360.09	\$ 5142.20	
		70"(1778mm)	1	TACE-5870-	SNCD		4380.09	5169.80	4410.69	5242.56	
64"(1626mm)	70"(1778mm)	70"(1778mm)	2	TACE-6470-	SNCD	\$	4432.23	\$ 5239.58	\$ 4466.35	\$ 5316.88	
		70"(1778mm)	1	TACE-6470-	SNCD		4432.23	5239.58	4466.35	5316.88	
29"(737mm)/29"(737mm)	46"(1168mm)	52"(1321mm)	1	TACE-4652-	SNCD	\$	4228.83	\$ 4853.90	\$ 4244.39	\$ 4902.10	
		58"(1473mm)	1	TACE-4658-	SNCD		4266.75	4938.86	4284.87	4992.34	
		64"(1626mm)	1	TACE-4664-	SNCD		4304.67	5020.88	4325.35	5079.47	
		70"(1778mm)	1	TACE-4670-	SNCD		4337.85	5098.16	4360.77	5161.54	
	52"(1321mm)	64"(1626mm)	70"(1778mm)	1	TACE-5264-	SNCD	\$	4352.07	\$ 5085.92	\$ 4375.95	\$ 5148.73
			70"(1778mm)	1	TACE-5270-	SNCD		4394.73	5172.68	4421.49	5240.92
	58"(1473mm)	64"(1626mm)	70"(1778mm)	1	TACE-5864-	SNCD	\$	4404.21	\$ 5155.70	\$ 4431.61	\$ 5223.05
			70"(1778mm)	1	TACE-5870-	SNCD		4451.61	5247.20	4482.21	5320.30
64"(1626mm)	70"(1778mm)	2	TACE-6470-	SNCD	\$	4503.75	\$ 5316.98	\$ 4537.87	\$ 5394.62		
Crank Adjustment											
23"(584mm)/23"(584mm)	40"(1016mm)	52"(1321mm)	1	TACE-4052-	SNCB		\$ 4570.85	\$ 5172.40	\$ 4583.85	\$ 5216.68	
		58"(1473mm)	1	TACE-4058-	SNCB		4599.29	5244.94	4614.21	5293.69	
		64"(1626mm)	1	TACE-4064-	SNCB		4632.47	5322.22	4649.63	5375.76	
46"(1168mm)	52"(1321mm)	58"(1473mm)	1	TACE-4652-	SNCB	\$	4608.77	\$ 5227.96	\$ 4624.33	\$ 5275.82	
		64"(1626mm)	1	TACE-4658-	SNCB		4646.69	5309.98	4664.81	5362.95	
		70"(1778mm)	1	TACE-4664-	SNCB		4684.61	5392.00	4705.29	5450.08	
		70"(1778mm)	1	TACE-4670-	SNCB		4717.79	5472.22	4740.71	5535.26	
52"(1321mm)	64"(1626mm)	70"(1778mm)	1	TACE-5264-	SNCB	\$	4732.01	\$ 5457.04	\$ 4755.89	\$ 5519.34	
		70"(1778mm)	1	TACE-5270-	SNCB		4774.67	5546.74	4801.43	5614.64	
58"(1473mm)	64"(1626mm)	70"(1778mm)	1	TACE-5864-	SNCB	\$	4784.15	\$ 5526.82	\$ 4811.55	\$ 5593.66	
		70"(1778mm)	1	TACE-5870-	SNCB		4831.55	5621.26	4862.15	5694.02	
64"(1626mm)	70"(1778mm)	2	TACE-6470-	SNCB	\$	4883.69	\$ 5691.04	\$ 4917.81	\$ 5768.34		
29"(737mm)/29"(737mm)	46"(1168mm)	52"(1321mm)	1	TACE-4652-	SNCB	\$	4680.29	\$ 5305.36	\$ 4695.85	\$ 5353.56	
		58"(1473mm)	1	TACE-4658-	SNCB		4718.21	5390.32	4736.33	5443.80	
		64"(1626mm)	1	TACE-4664-	SNCB		4756.13	5472.34	4776.81	5530.93	
		70"(1778mm)	1	TACE-4670-	SNCB		4789.31	5549.62	4812.23	5613.00	
	52"(1321mm)	64"(1626mm)	70"(1778mm)	1	TACE-5264-	SNCB	\$	4803.53	\$ 5537.38	\$ 4827.41	\$ 5600.19
			70"(1778mm)	1	TACE-5270-	SNCB		4846.19	5624.14	4872.95	5692.38
	58"(1473mm)	64"(1626mm)	70"(1778mm)	1	TACE-5864-	SNCB	\$	4855.67	\$ 5607.16	\$ 4883.07	\$ 5674.51
			70"(1778mm)	1	TACE-5870-	SNCB		4903.07	5698.66	4933.67	5771.76
64"(1626mm)	70"(1778mm)	2	TACE-6470-	SNCB	\$	4955.21	\$ 5768.44	\$ 4989.33	\$ 5846.08		

Planes Table — 90° Extended Corner — Wrap-Around Electric Adjustment

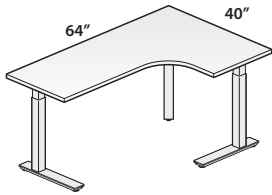

TACE-4064-NCEB
(Left-hand Orientation)

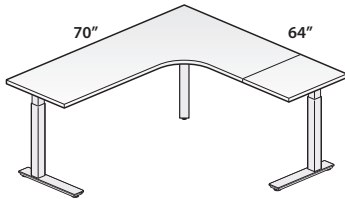

TACE-6470-NCEE
(Left-hand Orientation)
Class TA

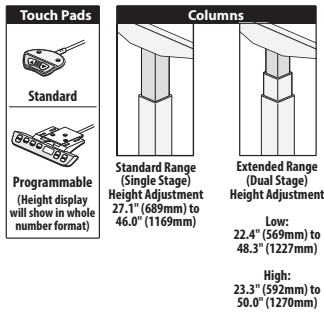

*Height range includes 1.18" (20mm) work surface



Features

- Includes:
 - 1.18"(30mm) thick work surface
 - C-leg telescoping base assembly with fixed J-Rail frame system
 - One center post leg
 - Standard or programmable touch pad switch
 - Wire management clips
 - Adjustable glides and hardware standard in black with 0.5"(13mm) of adjustment
 - 9'(2743mm) long black power cord with NEMA 5-15P plug and 5'(1524mm) cable extension
 - Worksurface:
 - High-Pressure Laminate (HPL) or Veneer with knife edge or 3mm edgeband option
 - 3mm Edgeband on user edge and 1mm on remaining edges
 - Top sizes 64"(1626mm) x 70"(1778mm) and larger will default to 2-pieces.
 - A 64"(1626mm) x 70"(1778mm) worksurface will include a 46"(1168mm) corner and 18"(457mm) rectangle extension.
 - Electric Height Adjustment:
 - Speed: 1.4"(36mm) per second
 - Standard Range (Single Stage) telescoping columns feature 18.9"(457mm) of continuous height adjustment.
 - Extended Range (Dual Stage) telescoping columns feature a range of 25.9"(658mm) - 26.7"(678mm) of continuous adjustment.
 - Base Assembly:
 - Telescoping inner columns default to matching or coordinating paint colors. See Finish pages for details.
 - Ships unassembled.
 - Depth and width shown in nominal dimensions.
- ## Specification Tips
- Worksurfaces are dimensioned to allow for 2"(51mm) pinch point clearance and cable accommodation. (e.g. 58"(1473mm) corner may be space planned as a 60"(1524mm) corner for modular planning purposes.
 - User orientation or "handedness" is determined by longest side of worksurface from seated position.
 - Total lifting capacity of table is 300 lbs (3-leg) including surface; applied weight should be evenly distributed.
 - For use with attached Worktools (e.g. monitor arms, screens, storage, wire management, etc.), see Product Application guidelines.
 - Not design for use with casters.
 - Application may require approval of local authority having jurisdiction (AHJ); ensure compliance before placing orders and installation.

To Order, Specify:

1) Product number, including:

1 Surface Options:

- L** Laminate
- W** Wood

2 Edge Options:

Laminate:

- J** Edgeband
- F** Knife

Wood:

- K** Edgeband
- U** Knife

3 Height Adjustment Actuator:

Standard Range
(Single Stage):

- E** Standard
- R** Programmable
(add **\$202.15** list)

Extended Range
(Dual Stage, Low):

- P** Standard
- S** Programmable
(add **\$202.15** list)

(Dual Stage, High):

- Q** Standard
- T** Programmable
(add **\$202.15** list)

4 Depth and Orientation:

Left-hand

23" deep tops:

- E** Left-hand
- H** Right-hand

29" deep tops:

- F** Left-hand
- J** Right-hand

2) Laminate surface color or wood finish color.

3) Edge trim color (laminite only).

4) Base trim color.

Note: \$63.50 upcharge list for Grade B trim colors.

Planes Table — 90° Extended Corner — Wrap-Around Electric Adjustment

Left/Right Depth	Width	Length	Top Pieces	Number	①②	③④	HPL A		HPL B	
							J	F	J	F
Standard Range (Single Stage)										
23"(584mm)/23"(584mm)	40"(1016mm)	46"(1168mm)	1	TACE-4046-	SNC		\$ 6287.11	\$6638.34	\$ 6388.36	\$ 6739.59
		52"(1321mm)	1	TACE-4052-	SNC		6325.07	6703.98	6428.98	6807.89
		58"(1473mm)	1	TACE-4058-	SNC		6357.98	6762.84	6464.17	6869.03
46"(1168mm)	52"(1321mm)	64"(1626mm)	1	TACE-4064-	SNC		6395.65	6826.46	6504.50	6935.31
		58"(1473mm)	1	TACE-4652-	SNC		\$6364.89	\$ 6754.18	\$ 6471.84	\$ 6861.13
		64"(1626mm)	1	TACE-4658-	SNC		6407.32	6822.56	6517.31	6932.55
52"(1321mm)	58"(1473mm)	70"(1778mm)	1	TACE-4664-	SNC		6449.75	6890.94	6562.78	7003.97
		64"(1626mm)	1	TACE-4670-	SNC		6487.71	6956.58	6603.40	7072.27
		70"(1778mm)	1	TACE-5258-	SNC		\$6456.66	\$6882.28	\$ 6570.45	\$ 6996.07
58"(1473mm)	64"(1626mm)	70"(1778mm)	1	TACE-5264-	SNC		6499.09	6950.66	6615.92	7067.49
		70"(1778mm)	1	TACE-5270-	SNC		6546.57	7025.82	6666.82	7146.07
		70"(1778mm)	1	TACE-5864-	SNC		\$ 6553.19	\$ 7015.14	\$ 6674.20	\$ 7136.15
64"(1626mm)	70"(1778mm)	70"(1778mm)	1	TACE-5870-	SNC		6605.43	7095.06	6730.24	7219.87
		70"(1778mm)	2	TACE-6470-	SNC		\$6659.53	\$ 7159.54	\$ 6788.52	\$ 7288.53
		70"(1778mm)	1	TACE-6470-	SNC		\$6436.99	\$ 6829.74	\$6543.94	\$ 6936.69
29"(737mm)/29"(737mm)	46"(1168mm)	58"(1473mm)	1	TACE-4658-	SNC		6479.71	6900.14	6589.70	7010.13
		64"(1626mm)	1	TACE-4664-	SNC		6522.14	6968.52	6635.17	7081.55
		70"(1778mm)	1	TACE-4670-	SNC		6559.81	7032.14	6675.50	7147.83
52"(1321mm)	58"(1473mm)	70"(1778mm)	1	TACE-5258-	SNC		\$6529.05	\$6959.86	\$6642.84	\$ 7073.65
		64"(1626mm)	1	TACE-5264-	SNC		6571.48	7028.24	6688.31	7145.07
		70"(1778mm)	1	TACE-5270-	SNC		6618.67	7101.38	6738.92	7221.63
58"(1473mm)	64"(1626mm)	70"(1778mm)	1	TACE-5864-	SNC		\$6625.58	\$ 7092.72	\$ 6746.59	\$ 7213.73
		70"(1778mm)	1	TACE-5870-	SNC		6677.53	7170.62	6802.34	7295.43
		70"(1778mm)	2	TACE-6470-	SNC		\$ 6731.63	\$ 7235.10	\$6860.62	\$ 7364.09
Extended Range (Dual Stage)										
23"(584mm)/23"(584mm)	40"(1016mm)	46"(1168mm)	1	TACE-4046-	SNC		\$8005.50	\$ 8356.73	\$ 8106.75	\$ 8457.98
		52"(1321mm)	1	TACE-4052-	SNC		8043.46	8422.37	8147.37	8526.28
		58"(1473mm)	1	TACE-4058-	SNC		8076.37	8481.23	8182.56	8587.42
46"(1168mm)	52"(1321mm)	64"(1626mm)	1	TACE-4064-	SNC		8114.04	8544.85	8222.89	8653.70
		58"(1473mm)	1	TACE-4652-	SNC		\$8083.28	\$ 8472.57	\$ 8190.23	\$ 8579.52
		64"(1626mm)	1	TACE-4658-	SNC		8125.71	8540.95	8235.70	8650.94
52"(1321mm)	58"(1473mm)	70"(1778mm)	1	TACE-4664-	SNC		8168.14	8609.33	8281.17	8722.36
		64"(1626mm)	1	TACE-4670-	SNC		8206.10	8674.97	8321.79	8790.66
		70"(1778mm)	1	TACE-5258-	SNC		\$ 8175.05	\$8600.67	\$8288.84	\$ 8714.46
58"(1473mm)	64"(1626mm)	70"(1778mm)	1	TACE-5264-	SNC		8217.48	8669.05	8334.31	8785.88
		70"(1778mm)	1	TACE-5270-	SNC		8264.96	8744.21	8385.21	8864.46
		70"(1778mm)	1	TACE-5864-	SNC		\$ 8271.58	\$ 8733.53	\$8392.59	\$ 8854.54
64"(1626mm)	70"(1778mm)	70"(1778mm)	1	TACE-5870-	SNC		8323.82	8813.45	8448.63	8938.26
		70"(1778mm)	2	TACE-6470-	SNC		\$ 8377.92	\$ 8877.93	\$ 8506.91	\$9006.92
		70"(1778mm)	1	TACE-6470-	SNC		\$ 8155.38	\$ 8548.13	\$8262.33	\$ 8655.08
29"(737mm)/29"(737mm)	46"(1168mm)	58"(1473mm)	1	TACE-4658-	SNC		8198.10	8618.53	8308.09	8728.52
		64"(1626mm)	1	TACE-4664-	SNC		8240.53	8686.91	8353.56	8799.94
		70"(1778mm)	1	TACE-4670-	SNC		8278.20	8750.53	8393.89	8866.22
52"(1321mm)	58"(1473mm)	70"(1778mm)	1	TACE-5258-	SNC		\$ 8247.44	\$ 8678.25	\$ 8361.23	\$ 8792.04
		64"(1626mm)	1	TACE-5264-	SNC		8289.87	8746.63	8406.70	8863.46
		70"(1778mm)	1	TACE-5270-	SNC		8337.06	8819.77	8457.31	8940.02
58"(1473mm)	64"(1626mm)	70"(1778mm)	1	TACE-5864-	SNC		\$ 8343.97	\$ 8811.11	\$8464.98	\$ 8932.12
		70"(1778mm)	1	TACE-5870-	SNC		8395.92	8889.01	8520.73	9013.82
		70"(1778mm)	2	TACE-6470-	SNC		\$8450.02	\$8953.49	\$ 8579.01	\$9082.48

Planes Table — 90° Extended Corner — Wrap-Around Electric Adjustment

Left/Right Depth	Width	Length	Top Pieces	Number	①②	③④	Wood A		Wood B			
							K	U	K	U		
Standard Range (Single Stage)												
23"(584mm)/23"(584mm)	40"(1016mm)	46"(1168mm)	1	TACE-4046-	SNC		\$6606.06	\$ 7160.57	\$ 6616.82	\$ 7199.89		
		52"(1321mm)	1	TACE-4052-	SNC		6639.24	7240.79	6652.24	7285.07		
		58"(1473mm)	1	TACE-4058-	SNC		6667.68	7313.33	6682.60	7362.08		
		64"(1626mm)	1	TACE-4064-	SNC		6700.86	7390.61	6718.02	7444.15		
	46"(1168mm)	52"(1321mm)	1	TACE-4652-	SNC		\$ 6677.16	\$ 7296.35	\$ 6692.72	\$ 7344.21		
		58"(1473mm)	1	TACE-4658-	SNC		6715.08	7378.37	6733.20	7431.34		
		64"(1626mm)	1	TACE-4664-	SNC		6753.00	7460.39	6773.68	7518.47		
		70"(1778mm)	1	TACE-4670-	SNC		6786.18	7540.61	6809.10	7603.65		
	52"(1321mm)	58"(1473mm)	1	TACE-5258-	SNC		\$ 6762.48	\$ 7443.41	\$ 6783.80	\$ 7500.60		
		64"(1626mm)	1	TACE-5264-	SNC		6800.40	7525.43	6824.28	7587.73		
		70"(1778mm)	1	TACE-5270-	SNC		6843.06	7615.13	6869.82	7683.03		
		58"(1473mm)	1	TACE-5864-	SNC		\$ 6852.54	\$ 7595.21	\$ 6879.94	\$ 7662.05		
64"(1626mm)	70"(1778mm)	1	TACE-5870-	SNC		6899.94	7689.65	6930.54	7762.41			
	70"(1778mm)	2	TACE-6470-	SNC		\$ 6952.08	\$ 7759.43	\$ 6986.20	\$ 7836.73			
	29"(737mm)/29"(737mm)	46"(1168mm)	52"(1321mm)	1	TACE-4652-	SNC		\$ 6748.68	\$ 7373.75	\$ 6764.24	\$ 7421.95	
			58"(1473mm)	1	TACE-4658-	SNC		6786.60	7458.71	6804.72	7512.19	
64"(1626mm)			1	TACE-4664-	SNC		6824.52	7540.73	6845.20	7599.32		
70"(1778mm)			1	TACE-4670-	SNC		6857.70	7618.01	6880.62	7681.39		
52"(1321mm)		58"(1473mm)	1	TACE-5258-	SNC		\$ 6834.00	\$ 7523.75	\$ 6855.32	\$ 7581.45		
		64"(1626mm)	1	TACE-5264-	SNC		6871.92	7605.77	6895.80	7668.58		
		70"(1778mm)	1	TACE-5270-	SNC		6914.58	7692.53	6941.34	7760.77		
		58"(1473mm)	1	TACE-5864-	SNC		\$ 6924.06	\$ 7675.55	\$ 6951.46	\$ 7742.90		
64"(1626mm)		70"(1778mm)	1	TACE-5870-	SNC		6971.46	7767.05	7002.06	7840.15		
		70"(1778mm)	2	TACE-6470-	SNC		\$ 7023.60	\$ 7836.83	\$ 7057.72	\$ 7914.47		
		Extended Range (Dual Stage)										
		23"(584mm)/23"(584mm)	40"(1016mm)	46"(1168mm)	1	TACE-4046-	SNC		\$ 8324.45	\$ 8878.96	\$ 8335.21	\$ 8918.28
52"(1321mm)	1			TACE-4052-	SNC		8357.63	8959.18	8370.63	9003.46		
58"(1473mm)	1			TACE-4058-	SNC		8386.07	9031.72	8400.99	9080.47		
64"(1626mm)	1			TACE-4064-	SNC		8419.25	9109.00	8436.41	9162.54		
46"(1168mm)	52"(1321mm)		1	TACE-4652-	SNC		\$ 8395.55	\$ 9014.74	\$ 8411.11	\$ 9062.60		
	58"(1473mm)		1	TACE-4658-	SNC		8433.47	9096.76	8451.59	9149.73		
	64"(1626mm)		1	TACE-4664-	SNC		8471.39	9178.78	8492.07	9236.86		
	70"(1778mm)		1	TACE-4670-	SNC		8504.57	9259.00	8527.49	9322.04		
52"(1321mm)	58"(1473mm)		1	TACE-5258-	SNC		\$ 8480.87	\$ 9161.80	\$ 8502.19	\$ 9218.99		
	64"(1626mm)		1	TACE-5264-	SNC		8518.79	9243.82	8542.67	9306.12		
	70"(1778mm)		1	TACE-5270-	SNC		8561.45	9333.52	8588.21	9401.42		
	58"(1473mm)		1	TACE-5864-	SNC		\$ 8570.93	\$ 9313.60	\$ 8598.33	\$ 9380.44		
64"(1626mm)	70"(1778mm)	1	TACE-5870-	SNC		8618.33	9408.04	8648.93	9480.80			
	70"(1778mm)	2	TACE-6470-	SNC		\$ 8670.47	\$ 9477.82	\$ 8704.59	\$ 9555.12			
	29"(737mm)/29"(737mm)	46"(1168mm)	52"(1321mm)	1	TACE-4652-	SNC		\$ 8467.07	\$ 9092.14	\$ 8482.63	\$ 9140.34	
			58"(1473mm)	1	TACE-4658-	SNC		8504.99	9177.10	8523.11	9230.58	
64"(1626mm)			1	TACE-4664-	SNC		8542.91	9259.12	8563.59	9317.71		
70"(1778mm)			1	TACE-4670-	SNC		8576.09	9336.40	8599.01	9399.78		
52"(1321mm)		58"(1473mm)	1	TACE-5258-	SNC		\$ 8552.39	\$ 9242.14	\$ 8573.71	\$ 9299.84		
		64"(1626mm)	1	TACE-5264-	SNC		8590.31	9324.16	8614.19	9386.97		
		70"(1778mm)	1	TACE-5270-	SNC		8632.97	9410.92	8659.73	9479.16		
		58"(1473mm)	1	TACE-5864-	SNC		\$ 8642.45	\$ 9393.94	\$ 8669.85	\$ 9461.29		
64"(1626mm)		70"(1778mm)	1	TACE-5870-	SNC		8689.85	9485.44	8720.45	9558.54		
		70"(1778mm)	2	TACE-6470-	SNC		\$ 8741.99	\$ 9555.22	\$ 8776.11	\$ 9632.86		

Planes Table — 90° Extended Corner — Notched

Electric Adjustment

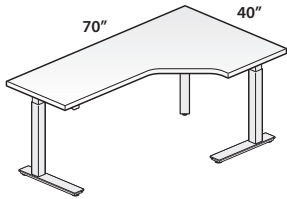

TACP-4070-NCEB
(Left-hand Orientation)

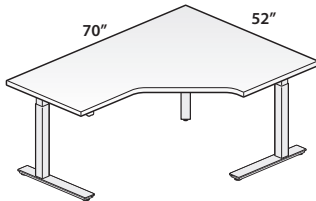

TACP-5270-NCEB
(Left-hand Orientation)
Class TA

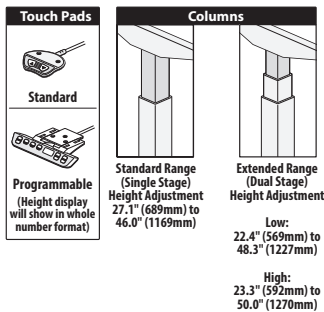

*Height range includes 1.18" (20mm) work surface



Features

- Includes:
 - 1.18"(30mm) thick work surface
 - C-leg telescoping base assembly with fixed J-Rail frame system
 - One center post leg
 - Standard or programmable touch pad switch
 - Wire management clips
 - Adjustable glides and hardware standard in black with 0.5"(13mm) of adjustment
 - 9'(2743mm) long black power cord with NEMA 5-15P plug and 5'(1524mm) cable extension
- Worksurface:
 - High-Pressure Laminate (HPL) or Veneer with knife edge or 3mm edgeband option
 - 3mm Edgeband on user edge and 1mm on remaining edges
 - Top sizes 64"(1626mm) x 70"(1778mm) and larger will default to 2-pieces.
 - A 64"(1626mm) x 70"(1778mm) worksurface will include a 46"(1168mm) corner and 18"(457mm) rectangle extension.
- Electric Height Adjustment:
 - Speed: 1.4"(36mm) per second
 - Standard Range (Single Stage) telescoping columns feature 18.9"(480mm) of continuous height adjustment.
 - Extended Range (Dual Stage) telescoping columns feature a range of 25.9"(658mm) - 26.7"(678mm) of continuous adjustment.
- Base Assembly:
 - Telescoping inner columns default to matching or coordinating paint colors. See Finish pages for details.
 - Ships unassembled.
- Depth and width shown in nominal dimensions.

Specification Tips

- Worksurfaces are dimensioned to allow for 2"(51mm) pinch point clearance and cable accommodation. (e.g. 58"(1473mm) corner may be space planned as a 60"(1524mm) corner for modular planning purposes.
- User orientation or "handedness" is determined by longest side of worksurface from seated position.
- Total lifting capacity of table is 300 lbs (3-leg) including surface; applied weight should be evenly distributed.
- For use with attached Worktools (e.g. monitor arms, screens, storage, wire management, etc.), see Product Application guidelines.
- Not design for use with casters.
- Application may require approval of local authority having jurisdiction (AHJ); ensure compliance before placing orders and installation.

To Order, Specify:

1) Product number, including:

1 Surface Options:

- L** Laminate
- W** Wood

2 Edge Options:

- Laminate:
- J** Edgeband
 - F** Knife
- Wood:
- K** Edgeband
 - U** Knife

3 Height Adjustment Actuator:

- Standard Range (Single Stage):
- E** Standard
 - R** Programmable (add \$202.15 list)

- Extended Range (Dual Stage, Low):
- P** Standard
 - S** Programmable (add \$202.15 list)

- (Dual Stage, High):
- Q** Standard
 - T** Programmable (add \$202.15 list)

4 Depth and Orientation:

- 23" deep tops:
- E** Left-hand
 - H** Right-hand
- 29" deep tops:
- F** Left-hand
 - J** Right-hand

2) Laminate surface color or wood finish color.

3) Edge trim color (laminated only).

4) Base trim color.

Note: \$63.50 upcharge list for Grade B trim colors.

Planes Table — 90° Extended Corner — Notched

Electric Adjustment

Left/Right Depth	Width	Length	Top Pieces	Number	①②	③④	HPL A		HPL B	
							J	F	J	F
Standard Range (Single Stage)										
23"(584mm)/23"(584mm)	40"(1016mm)	46"(1168mm)	1	TACP-4046-	SNC		\$ 6270.89	\$ 6622.12	\$ 6372.14	\$ 6723.37
		52"(1321mm)	1	TACP-4052-	SNC		6308.85	6687.76	6412.76	6791.67
		58"(1473mm)	1	TACP-4058-	SNC		6341.76	6746.62	6447.95	6852.81
46"(1168mm)	46"(1168mm)	64"(1626mm)	1	TACP-4064-	SNC		6379.43	6810.24	6488.28	6919.09
		52"(1321mm)	1	TACP-4652-	SNC		\$ 6348.67	\$ 6737.96	\$ 6455.62	\$ 6844.91
		58"(1473mm)	1	TACP-4658-	SNC		6391.10	6806.34	6501.09	6916.33
52"(1321mm)	52"(1321mm)	64"(1626mm)	1	TACP-4664-	SNC		6433.53	6874.72	6546.56	6987.75
		70"(1778mm)	1	TACP-4670-	SNC		6471.49	6940.36	6587.18	7056.05
		58"(1473mm)	1	TACP-5258-	SNC		\$6440.44	\$6866.06	\$6554.23	\$6979.85
58"(1473mm)	58"(1473mm)	64"(1626mm)	1	TACP-5264-	SNC		6482.87	6934.44	6599.70	7051.27
		70"(1778mm)	1	TACP-5270-	SNC		6530.35	7009.60	6650.60	7129.85
		64"(1626mm)	1	TACP-5864-	SNC		\$ 6536.97	\$ 6998.92	\$ 6657.98	\$ 7119.93
64"(1626mm)	64"(1626mm)	70"(1778mm)	1	TACP-5870-	SNC		6589.21	7078.84	6714.02	7203.65
		70"(1778mm)	2	TACP-6470-	SNC		\$ 6643.31	\$ 7143.32	\$ 6772.30	\$ 7272.31
		29"(737mm)/29"(737mm)	46"(1168mm)	52"(1321mm)	1	TACP-4652-	SNC		\$ 6420.77	\$ 6813.52
58"(1473mm)	58"(1473mm)	58"(1473mm)	1	TACP-4658-	SNC		6463.49	6883.92	6573.48	6993.91
		64"(1626mm)	1	TACP-4664-	SNC		6505.92	6952.30	6618.95	7065.33
		70"(1778mm)	1	TACP-4670-	SNC		6543.59	7015.92	6659.28	7131.61
52"(1321mm)	52"(1321mm)	58"(1473mm)	1	TACP-5258-	SNC		\$ 6512.83	\$6943.64	\$6626.62	\$ 7057.43
		64"(1626mm)	1	TACP-5264-	SNC		6555.26	7012.02	6672.09	7128.85
		70"(1778mm)	1	TACP-5270-	SNC		6602.45	7085.16	6722.70	7205.41
58"(1473mm)	58"(1473mm)	64"(1626mm)	1	TACP-5864-	SNC		\$6609.36	\$ 7076.50	\$ 6730.37	\$ 7197.51
		70"(1778mm)	1	TACP-5870-	SNC		6661.31	7154.40	6786.12	7279.21
		64"(1626mm)	70"(1778mm)	2	TACP-6470-	SNC		\$ 6715.41	\$ 7218.88	\$6844.40
Extended Range (Dual Stage)										
23"(584mm)/23"(584mm)	40"(1016mm)	46"(1168mm)	1	TACP-4046-	SNC		\$ 7989.28	\$ 8340.51	\$8090.53	\$ 8441.76
		52"(1321mm)	1	TACP-4052-	SNC		8027.24	8406.15	8131.15	8510.06
		58"(1473mm)	1	TACP-4058-	SNC		8060.15	8465.01	8166.34	8571.20
46"(1168mm)	46"(1168mm)	64"(1626mm)	1	TACP-4064-	SNC		8097.82	8528.63	8206.67	8637.48
		52"(1321mm)	1	TACP-4652-	SNC		\$8067.06	\$8456.35	\$ 8174.01	\$8563.30
		58"(1473mm)	1	TACP-4658-	SNC		8109.49	8524.73	8219.48	8634.72
52"(1321mm)	52"(1321mm)	64"(1626mm)	1	TACP-4664-	SNC		8151.92	8593.11	8264.95	8706.14
		70"(1778mm)	1	TACP-4670-	SNC		8189.88	8658.75	8305.57	8774.44
		58"(1473mm)	1	TACP-5258-	SNC		\$ 8158.83	\$8584.45	\$ 8272.62	\$8698.24
58"(1473mm)	58"(1473mm)	64"(1626mm)	1	TACP-5264-	SNC		8201.26	8652.83	8318.09	8769.66
		70"(1778mm)	1	TACP-5270-	SNC		8248.74	8727.99	8368.99	8848.24
		64"(1626mm)	1	TACP-5864-	SNC		\$ 8255.36	\$ 8717.31	\$ 8376.37	\$ 8838.32
64"(1626mm)	64"(1626mm)	70"(1778mm)	1	TACP-5870-	SNC		8307.60	8797.23	8432.41	8922.04
		70"(1778mm)	2	TACP-6470-	SNC		\$ 8361.70	\$ 8861.71	\$8490.69	\$8990.70
		29"(737mm)/29"(737mm)	46"(1168mm)	52"(1321mm)	1	TACP-4652-	SNC		\$ 8139.16	\$ 8531.91
58"(1473mm)	58"(1473mm)	58"(1473mm)	1	TACP-4658-	SNC		8181.88	8602.31	8291.87	8712.30
		64"(1626mm)	1	TACP-4664-	SNC		8224.31	8670.69	8337.34	8783.72
		70"(1778mm)	1	TACP-4670-	SNC		8261.98	8734.31	8377.67	8850.00
52"(1321mm)	52"(1321mm)	58"(1473mm)	1	TACP-5258-	SNC		\$ 8231.22	\$8662.03	\$ 8345.01	\$ 8775.82
		64"(1626mm)	1	TACP-5264-	SNC		8273.65	8730.41	8390.48	8847.24
		70"(1778mm)	1	TACP-5270-	SNC		8320.84	8803.55	8441.09	8923.80
58"(1473mm)	58"(1473mm)	64"(1626mm)	1	TACP-5864-	SNC		\$ 8327.75	\$8794.89	\$8448.76	\$ 8915.90
		70"(1778mm)	1	TACP-5870-	SNC		8379.70	8872.79	8504.51	8997.60
		64"(1626mm)	70"(1778mm)	2	TACP-6470-	SNC		\$8433.80	\$ 8937.27	\$8562.79

Planes Table — 90° Extended Corner — Notched

Electric Adjustment

Left/Right Depth	Width	Length	Top Pieces	Number	①②	③④	Wood A		Wood B	
							K	U	K	U
Standard Range (Single Stage)										
23"(584mm)/23"(584mm)	40"(1016mm)	46"(1168mm)	1	TACP-4046-	SNC		\$ 6302.42	\$ 6856.93	\$ 6313.36	\$ 6896.43
		52"(1321mm)	1	TACP-4052-	SNC		6335.60	6937.15	6348.78	6981.61
		58"(1473mm)	1	TACP-4058-	SNC		6364.04	7009.69	6379.14	7058.62
		64"(1626mm)	1	TACP-4064-	SNC		6397.22	7086.97	6414.56	7140.69
46"(1168mm)	52"(1321mm)	58"(1473mm)	1	TACP-4652-	SNC		\$ 6373.52	\$ 6992.71	\$ 6389.26	\$ 7040.75
		64"(1626mm)	1	TACP-4658-	SNC		6411.44	7074.73	6429.74	7127.88
		70"(1778mm)	1	TACP-4664-	SNC		6449.36	7156.75	6470.22	7215.01
		70"(1778mm)	1	TACP-4670-	SNC		6482.54	7236.97	6505.64	7300.19
52"(1321mm)	58"(1473mm)	64"(1626mm)	1	TACP-5258-	SNC		\$ 6458.84	\$ 7139.77	\$ 6480.34	\$ 7197.14
		70"(1778mm)	1	TACP-5264-	SNC		6496.76	7221.79	6520.82	7284.27
		70"(1778mm)	1	TACP-5270-	SNC		6539.42	7311.49	6566.36	7379.57
		70"(1778mm)	1	TACP-5270-	SNC		6539.42	7311.49	6566.36	7379.57
58"(1473mm)	64"(1626mm)	70"(1778mm)	1	TACP-5864-	SNC		\$ 6548.90	\$ 7291.57	\$ 6576.48	\$ 7358.59
		70"(1778mm)	1	TACP-5870-	SNC		6596.30	7386.01	6627.08	7458.95
		70"(1778mm)	1	TACP-5870-	SNC		6596.30	7386.01	6627.08	7458.95
		70"(1778mm)	1	TACP-5870-	SNC		6596.30	7386.01	6627.08	7458.95
64"(1626mm)	70"(1778mm)	70"(1778mm)	2	TACP-6470-	SNC		\$ 6648.44	\$ 7455.79	\$ 6682.74	\$ 7533.27
		70"(1778mm)	2	TACP-6470-	SNC		6648.44	7455.79	6682.74	7533.27
		70"(1778mm)	2	TACP-6470-	SNC		6648.44	7455.79	6682.74	7533.27
		70"(1778mm)	2	TACP-6470-	SNC		6648.44	7455.79	6682.74	7533.27
Extended Range (Dual Stage)										
23"(584mm)/23"(584mm)	40"(1016mm)	46"(1168mm)	1	TACP-4046-	SNC		\$ 8020.81	\$ 8575.32	\$ 8031.75	\$ 8614.82
		52"(1321mm)	1	TACP-4052-	SNC		8053.99	8655.54	8067.17	8700.00
		58"(1473mm)	1	TACP-4058-	SNC		8082.43	8728.08	8097.53	8777.01
		64"(1626mm)	1	TACP-4064-	SNC		8115.61	8805.36	8132.95	8859.08
46"(1168mm)	52"(1321mm)	58"(1473mm)	1	TACP-4652-	SNC		\$ 8091.91	\$ 8711.10	\$ 8107.65	\$ 8759.14
		64"(1626mm)	1	TACP-4658-	SNC		8129.83	8793.12	8148.13	8846.27
		70"(1778mm)	1	TACP-4664-	SNC		8167.75	8875.14	8188.61	8933.40
		70"(1778mm)	1	TACP-4670-	SNC		8200.93	8955.36	8224.03	9018.58
52"(1321mm)	58"(1473mm)	64"(1626mm)	1	TACP-5258-	SNC		\$ 8177.23	\$ 8858.16	\$ 8198.73	\$ 8915.53
		70"(1778mm)	1	TACP-5264-	SNC		8215.15	8940.18	8239.21	9002.66
		70"(1778mm)	1	TACP-5270-	SNC		8257.81	9029.88	8284.75	9097.96
		70"(1778mm)	1	TACP-5270-	SNC		8257.81	9029.88	8284.75	9097.96
58"(1473mm)	64"(1626mm)	70"(1778mm)	1	TACP-5864-	SNC		\$ 8267.29	\$ 9009.96	\$ 8294.87	\$ 9076.98
		70"(1778mm)	1	TACP-5870-	SNC		8314.69	9104.40	8345.47	9177.34
		70"(1778mm)	1	TACP-5870-	SNC		8314.69	9104.40	8345.47	9177.34
		70"(1778mm)	1	TACP-5870-	SNC		8314.69	9104.40	8345.47	9177.34
64"(1626mm)	70"(1778mm)	70"(1778mm)	2	TACP-6470-	SNC		\$ 8366.83	\$ 9174.18	\$ 8401.13	\$ 9251.66
		70"(1778mm)	2	TACP-6470-	SNC		8366.83	9174.18	8401.13	9251.66
		70"(1778mm)	2	TACP-6470-	SNC		8366.83	9174.18	8401.13	9251.66
		70"(1778mm)	2	TACP-6470-	SNC		8366.83	9174.18	8401.13	9251.66
Extended Range (Dual Stage)										
29"(737mm)/29"(737mm)	46"(1168mm)	52"(1321mm)	1	TACP-4652-	SNC		\$ 8163.43	\$ 8788.50	\$ 8179.17	\$ 8836.88
		58"(1473mm)	1	TACP-4658-	SNC		8201.35	8873.46	8219.65	8927.12
		64"(1626mm)	1	TACP-4664-	SNC		8239.27	8955.48	8260.13	9014.25
		70"(1778mm)	1	TACP-4670-	SNC		8272.45	9032.76	8295.55	9096.32
52"(1321mm)	58"(1473mm)	64"(1626mm)	1	TACP-5258-	SNC		\$ 8248.75	\$ 8938.50	\$ 8270.25	\$ 8996.38
		70"(1778mm)	1	TACP-5264-	SNC		8286.67	9020.52	8310.73	9083.51
		70"(1778mm)	1	TACP-5270-	SNC		8329.33	9107.28	8356.27	9175.70
		70"(1778mm)	1	TACP-5270-	SNC		8329.33	9107.28	8356.27	9175.70
58"(1473mm)	64"(1626mm)	70"(1778mm)	1	TACP-5864-	SNC		\$ 8338.81	\$ 9090.30	\$ 8366.39	\$ 9157.83
		70"(1778mm)	1	TACP-5870-	SNC		8386.21	9181.80	8416.99	9255.08
		70"(1778mm)	1	TACP-5870-	SNC		8386.21	9181.80	8416.99	9255.08
		70"(1778mm)	1	TACP-5870-	SNC		8386.21	9181.80	8416.99	9255.08
64"(1626mm)	70"(1778mm)	70"(1778mm)	2	TACP-6470-	SNC		\$ 8438.35	\$ 9251.58	\$ 8472.65	\$ 9329.40
		70"(1778mm)	2	TACP-6470-	SNC		8438.35	9251.58	8472.65	9329.40
		70"(1778mm)	2	TACP-6470-	SNC		8438.35	9251.58	8472.65	9329.40
		70"(1778mm)	2	TACP-6470-	SNC		8438.35	9251.58	8472.65	9329.40

Planes Table — 120° Corner — Wrap-Around

Electric Adjustment

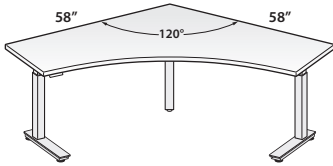

TACZ-5858-NCEB
Class TA

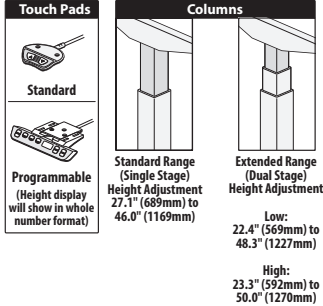

*Height range includes
1.18" (20mm) worksurface



Features

- Includes:
 - 1.18"(30mm) thick work surface
 - C-leg telescoping base assembly with fixed J-Rail frame system
 - One center post leg
 - Standard or programmable touch pad switch
 - Wire management clips
 - Adjustable glides and hardware standard in black with 0.5"(13mm) of adjustment
 - 9'(2743mm) long black power cord with NEMA 5-15P plug and 5'(1524mm) cable extension
- Worksurface:
 - High-Pressure Laminate (HPL) or Veneer with knife edge or 3mm edgeband option
 - 3mm Edgeband on user edge and 1mm on remaining edges
- Electric Height Adjustment:
 - Speed: 1.4"(36mm) per second
 - Standard Range (Single Stage) telescoping columns feature 18.9"(480mm) of continuous height adjustment.
 - Extended Range (Dual Stage) telescoping columns feature a range of 25.9"(658mm) - 26.7"(678mm) of continuous adjustment.
- Base Assembly:
 - Telescoping inner columns default to matching or coordinating paint colors. See Finish pages for details.
 - Ships unassembled.
- Depth and width shown in nominal dimensions.

Specification Tips

- Worksurfaces are dimensioned to allow for 2"(51mm) pinch point clearance and cable accommodation. (e.g. 58"(1473mm) corner may be space planned as a 60"(1524mm) corner for modular planning purposes.
- Total lifting capacity of table is 300 lbs (3-leg) including surface; applied weight should be evenly distributed.
- For use with attached Worktools (e.g. monitor arms, screens, storage, wire management, etc.), see Product Application guidelines.
- Not design for use with casters.
- Application may require approval of local authority having jurisdiction (AHJ); ensure compliance before placing orders and installation.

To Order, Specify:

1) Product number, including:

1 Surface Options:

- L** Laminate
- W** Wood

2 Edge Options:

Laminate:

- J** Edgeband
- F** Knife

Wood:

- K** Edgeband
- U** Knife

3 Height Adjustment Actuator:

Standard Range
(Single Stage):

- E** Standard
- R** Programmable
(add **\$202.15** list)

Extended Range
(Dual Stage, Low):

- P** Standard
- S** Programmable
(add **\$202.15** list)

(Dual Stage, High):

- Q** Standard
- T** Programmable
(add **\$202.15** list)

2) Laminate surface color or wood finish color.

3) Edge trim color (laminate only).

4) Base trim color.

Note: \$63.50 upcharge list for Grade B trim colors.

Planes Table — 120° Corner — Wrap-Around

Electric Adjustment

Left/Right Depth	Width	Length	Top Pieces	Number	①②	③	HPL A		HPL B	
							J	F	J	F
Standard Range (Single Stage)										
23"(584mm)/23"(584mm)	52"(1321mm)	52"(1321mm)	1	TACZ-5252-	SNC	B	\$ 6518.91	\$6600.00	\$ 6518.91	\$6600.00
	58"(1473mm)	58"(1473mm)	1	TACZ-5858-	SNC	B	6647.97	6643.68	6647.97	6643.68
29"(737mm)/29"(737mm)	52"(1321mm)	52"(1321mm)	1	TACZ-5252-	SNC	C	\$6590.43	\$ 6675.68	\$6590.43	\$ 6675.68
	58"(1473mm)	58"(1473mm)	1	TACZ-5858-	SNC	C	6719.49	6721.44	6719.49	6721.44
Extended Range (Dual Stage)										
23"(584mm)/23"(584mm)	52"(1321mm)	52"(1321mm)	1	TACZ-5252-	SNC	B	\$ 8237.30	\$ 8318.39	\$ 8237.30	\$ 8318.39
	58"(1473mm)	58"(1473mm)	1	TACZ-5858-	SNC	B	8366.36	8362.07	8366.36	8362.07
29"(737mm)/29"(737mm)	52"(1321mm)	52"(1321mm)	1	TACZ-5252-	SNC	C	\$8308.82	\$ 8394.07	\$8308.82	\$ 8394.07
	58"(1473mm)	58"(1473mm)	1	TACZ-5858-	SNC	C	8437.88	8439.83	8437.88	8439.83

Left/Right Depth	Width	Length	Top Pieces	Number	①②	③	Wood A		Wood B	
							K	U	K	U
Standard Range (Single Stage)										
23"(584mm)/23"(584mm)	52"(1321mm)	52"(1321mm)	1	TACZ-5252-	SNC	B	\$ 6827.13	\$ 7658.79	\$6868.04	\$ 7674.44
	58"(1473mm)	58"(1473mm)	1	TACZ-5858-	SNC	B	6970.60	7787.52	7019.93	7803.17
29"(737mm)/29"(737mm)	52"(1321mm)	52"(1321mm)	1	TACZ-5252-	SNC	C	\$6898.65	\$ 7742.57	\$6939.56	\$ 7758.22
	58"(1473mm)	58"(1473mm)	1	TACZ-5858-	SNC	C	7042.12	7877.43	7091.45	7893.08
Extended Range (Dual Stage)										
23"(584mm)/23"(584mm)	52"(1321mm)	52"(1321mm)	1	TACZ-5252-	SNC	B	\$8545.52	\$ 9377.18	\$8586.43	\$9392.83
	58"(1473mm)	58"(1473mm)	1	TACZ-5858-	SNC	B	8688.99	9505.91	8738.32	9521.56
29"(737mm)/29"(737mm)	52"(1321mm)	52"(1321mm)	1	TACZ-5252-	SNC	C	\$ 8617.04	\$9460.96	\$ 8657.95	\$ 9476.61
	58"(1473mm)	58"(1473mm)	1	TACZ-5858-	SNC	C	8760.51	9595.82	8809.84	9611.47

Planes Base for Rectangular Table

Incremental or Crank Adjustment

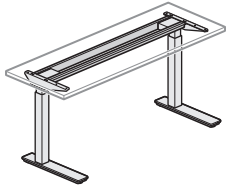

TMRA
Class TA - GSA; Open Market



Incremental Adjustment
Height Adjustment
22" (559mm) to
35" (889mm)

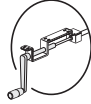

Crank Adjustment
Height Adjustment
27" (686mm) to
45" (1143mm)

**Height range includes 1.18" (20mm) worksurface*

Features

- Includes:
 - Two telescoping columns
 - Pair of steel feet (C-leg)
 - Fixed J-Rail frame system
 - Two End Brackets
 - Incremental or hand crank height adjustment mechanism
 - Wire management clips
 - Adjustable glides and hardware standard in black with 0.5"(13mm) of adjustment
- Incremental Height adjustment:
 - Telescoping columns feature 13"(330mm) of adjustment set in 1"(25mm) increments.
 - Button head screws are standard in bright zinc.
 - Thumbscrew replacement for button head screw is available; separately specified.
- Hand Crank adjustment:
 - Telescoping columns feature 18"(457mm) of adjustment.
 - 1"(25mm) of vertical movement for every 6 turns
 - Hand crank is field installed on left or right side and retracts under worksurface.
- Telescoping inner columns default to matching or coordinating paint colors. See Finish pages for details.
- Ships unassembled.
- Depth and width shown in nominal dimension.

Specification Tips

- **Maximum work top width overhang allowed is 6"(152mm) on each side.**
- **Refer to Planes Height Adjustable Table for each work surface top weight.**
- Not designed to be used with casters.
- Select a worksurface that accommodates 1"(25mm) of pinch point clearance on all sides and meets at least a NFPA class C flammability rating; refer to Specification Guide for application guidelines when surrounded by walls, panels or other worksurfaces.
- Total lifting capacity of table is 150 lbs including surface; applied weight should be evenly distributed.
- For applications using attached worktools (monitor arms, screens, storage, wire management, etc.), see Product Application guidelines.
- Base Only Application may require approval of local authority having jurisdiction (AHJ); ensure compliance before placing orders and installation.

To Order, Specify:

- 1) Product number.
- 2) Base trim color.

Planes Base for Rectangular Table

Incremental or Crank Adjustment

Top Depth	Minimum Top Width	Maximum Top Width	Number	Trim	
				A	B
Incremental Adjustment					
23"(584mm)	34"(864mm)	39"(991mm)	TMRA-2334-NNNNCD	\$ 1564.33	\$ 1627.83
	40"(1016mm)	45"(1143mm)	TMRA-2340-NNNNCD	1628.59	1692.09
	46"(1168mm)	51"(1295mm)	TMRA-2346-NNNNCD	1692.85	1756.35
	52"(1321mm)	57"(1448mm)	TMRA-2352-NNNNCD	1757.11	1820.61
	58"(1473mm)	63"(1600mm)	TMRA-2358-NNNNCD	1821.37	1884.87
	64"(1626mm)	67"(1702mm)	TMRA-2364-NNNNCD	1885.63	1949.13
	70"(1778mm)	77"(1956mm)	TMRA-2370-NNNNCD	1949.89	2013.39
29"(737mm)	34"(864mm)	39"(991mm)	TMRA-2934-NNNNCD	\$ 1594.93	\$ 1658.43
	40"(1016mm)	45"(1143mm)	TMRA-2940-NNNNCD	1659.19	1722.69
	46"(1168mm)	51"(1295mm)	TMRA-2946-NNNNCD	1723.45	1786.95
	52"(1321mm)	57"(1448mm)	TMRA-2952-NNNNCD	1787.71	1851.21
	58"(1473mm)	63"(1600mm)	TMRA-2958-NNNNCD	1851.97	1915.47
	64"(1626mm)	67"(1702mm)	TMRA-2964-NNNNCD	1916.23	1979.73
	70"(1778mm)	77"(1956mm)	TMRA-2970-NNNNCD	1980.49	2043.99
Crank Adjustment					
23"(584mm)	34"(864mm)	39"(991mm)	TMRA-2334-NNNNCB	\$2362.87	\$ 2426.37
	40"(1016mm)	45"(1143mm)	TMRA-2340-NNNNCB	2427.13	2490.63
	46"(1168mm)	51"(1295mm)	TMRA-2346-NNNNCB	2491.39	2554.89
	52"(1321mm)	57"(1448mm)	TMRA-2352-NNNNCB	2555.65	2619.15
	58"(1473mm)	63"(1600mm)	TMRA-2358-NNNNCB	2619.91	2683.41
	64"(1626mm)	67"(1702mm)	TMRA-2364-NNNNCB	2684.17	2747.67
	70"(1778mm)	77"(1956mm)	TMRA-2370-NNNNCB	2748.43	2811.93
29"(737mm)	34"(864mm)	39"(991mm)	TMRA-2934-NNNNCB	\$2393.47	\$ 2456.97
	40"(1016mm)	45"(1143mm)	TMRA-2940-NNNNCB	2457.73	2521.23
	46"(1168mm)	51"(1295mm)	TMRA-2946-NNNNCB	2521.99	2585.49
	52"(1321mm)	57"(1448mm)	TMRA-2952-NNNNCB	2586.25	2649.75
	58"(1473mm)	63"(1600mm)	TMRA-2958-NNNNCB	2650.51	2714.01
	64"(1626mm)	67"(1702mm)	TMRA-2964-NNNNCB	2714.77	2778.27
	70"(1778mm)	77"(1956mm)	TMRA-2970-NNNNCB	2779.03	2842.53

Planes Base for Rectangular Table

Electric Adjustment

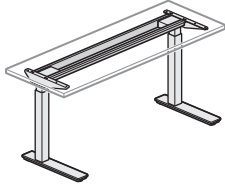

TMRA
Class TA - GSA; Open Market

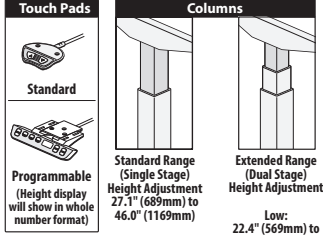

*Height range includes 1.18" (20mm) worksurface



Features

- Includes:
 - Two telescoping columns
 - Pair of steel feet (C-leg)
 - Fixed J-Rail frame system
 - Two End Brackets
 - Control Box
 - Standard or programmable touch pad switch
 - Wire management clips
 - Adjustable glides and hardware standard in black with 0.5"(13mm) of adjustment
 - 9'(2743mm) long black power cord with NEMA 5-15P Plug to the building
- Electric Height Adjustment:
 - Speed: 1.4"(36mm) per second
 - Standard Range (Single Stage) telescoping columns feature 18.9"(480mm) of continuous adjustment.
 - Extended Range (Dual Stage) telescoping columns feature a range of 25.9"(658mm) - 26.7"(678mm) of continuous adjustment.
- Telescoping inner columns default to matching or coordinating paint colors. See Finish pages for details.
- Ships unassembled.
- Depth and width shown in nominal dimension.

Specification Tips

- Maximum work top width overhang allowed is 6"(152mm) on each side.**
- Refer to specification guide for work surface weight.**
- Select a worksurface that accommodates 1"(25mm) of pinch point clearance on all sides and meets at least a NFPA class C flammability rating; refer to Specification Guide for application guidelines when surrounded by walls, panels or other worksurfaces.
- Total lifting capacity of table is 250 lbs including surface; applied weight should be evenly distributed.
- For applications using attached worktools (monitor arms, screens, storage, wire management, etc.), see Product Application guidelines.
- Separately specified caster kit available.
- Base Only Application may require approval of local authority having jurisdiction (AHJ); ensure compliance before placing orders and installation.

To Order, Specify:

1) Product number, including:

1 Height Adjustment Actuator Options:

Standard Range
(Single Stage):

E Standard

R Programmable
(add **\$202.15** list)

Extended Range
(Dual Stage, Low):

S Programmable
(add **\$202.15** list)

(Dual Stage, High):

Q Standard

T Programmable
(add **\$202.15** list)

2) Base trim color.

Planes Base for Rectangular Table

Electric Adjustment

Top Depth	Minimum Top Width	Maximum Top Width	Number	①	Trim A	B
Standard Range (Single Stage)						
23"(584mm)	34"(864mm)	39"(991mm)	TMRA-2334-NNNNC		\$ 3164.36	\$ 3227.86
	40"(1016mm)	45"(1143mm)	TMRA-2340-NNNNC		3228.62	3292.12
	46"(1168mm)	51"(1295mm)	TMRA-2346-NNNNC		3292.88	3356.38
	52"(1321mm)	57"(1448mm)	TMRA-2352-NNNNC		3357.14	3420.64
	58"(1473mm)	63"(1600mm)	TMRA-2358-NNNNC		3421.40	3484.90
	64"(1626mm)	69"(1753mm)	TMRA-2364-NNNNC		3485.66	3549.16
	70"(1778mm)	75"(1905mm)	TMRA-2370-NNNNC		3549.92	3613.42
29"(737mm)	34"(864mm)	39"(991mm)	TMRA-2934-NNNNC		\$ 3194.96	\$ 3258.46
	40"(1016mm)	45"(1143mm)	TMRA-2940-NNNNC		3259.22	3322.72
	46"(1168mm)	51"(1295mm)	TMRA-2946-NNNNC		3323.48	3386.98
	52"(1321mm)	57"(1448mm)	TMRA-2952-NNNNC		3387.74	3451.24
	58"(1473mm)	63"(1600mm)	TMRA-2958-NNNNC		3452.00	3515.50
	64"(1626mm)	69"(1753mm)	TMRA-2964-NNNNC		3516.26	3579.76
	70"(1778mm)	75"(1905mm)	TMRA-2970-NNNNC		3580.52	3644.02
Extended Range (Dual Stage)						
23"(584mm)	34"(864mm)	39"(991mm)	TMRA-2334-NNNNC		\$4395.00	\$4458.50
	40"(1016mm)	45"(1143mm)	TMRA-2340-NNNNC		4459.26	4522.76
	46"(1168mm)	51"(1295mm)	TMRA-2346-NNNNC		4523.52	4587.02
	52"(1321mm)	57"(1448mm)	TMRA-2352-NNNNC		4587.78	4651.28
	58"(1473mm)	63"(1600mm)	TMRA-2358-NNNNC		4652.04	4715.54
	64"(1626mm)	69"(1753mm)	TMRA-2364-NNNNC		4716.30	4779.80
	70"(1778mm)	75"(1905mm)	TMRA-2370-NNNNC		4780.56	4844.06
29"(737mm)	34"(864mm)	39"(991mm)	TMRA-2934-NNNNC		\$4425.60	\$ 4489.10
	40"(1016mm)	45"(1143mm)	TMRA-2940-NNNNC		4489.86	4553.36
	46"(1168mm)	51"(1295mm)	TMRA-2946-NNNNC		4554.12	4617.62
	52"(1321mm)	57"(1448mm)	TMRA-2952-NNNNC		4618.38	4681.88
	58"(1473mm)	63"(1600mm)	TMRA-2958-NNNNC		4682.64	4746.14
	64"(1626mm)	69"(1753mm)	TMRA-2964-NNNNC		4746.90	4810.40
	70"(1778mm)	75"(1905mm)	TMRA-2970-NNNNC		4811.16	4874.66

Planes Base for 90° Equal Corner Table

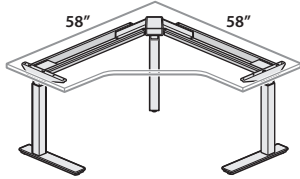
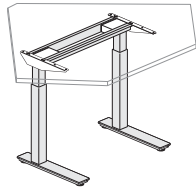

Electric Adjustment

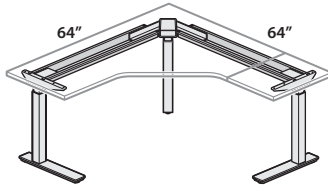

TMCR-5858-NCEBT

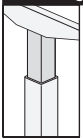
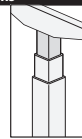

TMCR-6464-NCEE
(Left-hand Orientation)
Class TA - GSA; Open Market

Touch Pads	Columns	
 Standard	 Standard Range (Single Stage) Height Adjustment 27.1" (689mm) to 46.0" (1169mm)	 Extended Range (Dual Stage) Height Adjustment Low: 22.4" (569mm) to 48.3" (1227mm) High: 23.3" (592mm) to 50.0" (1270mm)
 Programmable (Height display will show in whole number format)	*Height range includes 1.18" (20mm) workspace	



Features

- Includes:
 - Two telescoping columns
 - One center post leg (with top widths 52"(1321mm) or greater)
 - Pair of steel feet (C-leg)
 - Fixed J-Rail frame system
 - Two End Brackets
 - Control Box
 - Standard or programmable touch pad switch
 - Wire management clips
 - Adjustable glides and hardware standard in black with 0.5"(13mm) of adjustment
 - 9'(2743mm) long black power cord with NEMA 5-15P Plug and 5'(1524mm) cable extension (with top width 52"(1321mm) or greater)
- Electric Height Adjustment:
 - Speed: 1.4"(36mm) per second
 - Standard Range (Single Stage) telescoping columns feature 18.9"(457mm) of continuous adjustment.
 - Extended Range (Dual Stage) telescoping columns feature a range of 25.9"(658mm) - 26.7"(678mm) of continuous adjustment.
- Telescoping inner columns default to matching or coordinating paint colors. See Finish pages for details.
- Ships unassembled.
- Depth and width shown in nominal dimension.

Specification Tips

- **Maximum work top width overhang allowed is 6"(152mm) on each side.**
- **Refer to specification guide for work surface weight.**
- Select a worksurface that accommodates 1"(25mm) of pinch point clearance on all sides and meets at least a NFPA class C flammability rating; refer to Specification Guide for application guidelines when surrounded by walls, panels or other worksurfaces.
- Total lifting capacity of table is 250 lbs (2-leg) or 300 lbs (3-leg) including surface; applied weight should be evenly distributed.
- For use with attached Worktools (e.g. monitor arms, screens, storage, wire management, etc.), see Product Application guidelines.
- Separately specified caster kit available for 2-leg models ONLY.
- Application may require approval of local authority having jurisdiction (AHJ); ensure compliance before placing orders and installation.

To Order, Specify:

1) Product number, including:

1 Height Adjustment Actuator Options:

Standard Range

(Single Stage):

E Standard

R Programmable

(add **\$202.15** list)

Extended Range

(Dual Stage, Low):

P Standard

S Programmable

(add **\$202.15** list)

(Dual Stage, High):

Q Standard

T Programmable

(add **\$202.15** list)

2) Base trim color.

Planes Base for 90° Equal Corner Table

Electric Adjustment

Top Left/Right Depth	Minimum Top Width	Maximum Top Width	Leg Column	Number	①	Trim A	B
Standard Range (Single Stage)							
23"(584mm)/23"(584mm)	34"(864mm)	39"(991mm)	1	TMCR-3434-NNNNC	B	\$ 3133.48	\$ 3196.98
	40"(1016mm)	45"(1143mm)	1	TMCR-4040-NNNNC	B	3197.74	3261.24
	46"(1168mm)	51"(1295mm)	1	TMCR-4646-NNNNC	B	3262.00	3325.50
	52"(1321mm)	57"(1448mm)	1	TMCR-5252-NNNNC	B	7361.12	7424.62
	58"(1473mm)	63"(1600mm)	1	TMCR-5858-NNNNC	B	7425.38	7488.88
	64"(1626mm)	69"(1753mm)	1	TMCR-6464-NNNNC	B	7489.64	7553.14
	70"(1778mm)	75"(1905mm)	1	TMCR-7070-NNNNC	B	7553.90	7617.40
	29"(737mm)/29"(737mm)	52"(1321mm)	57"(1448mm)	1	TMCR-5252-NNNNC	C	\$ 7391.72
58"(1473mm)		63"(1600mm)	1	TMCR-5858-NNNNC	C	7455.98	7519.48
64"(1626mm)		69"(1753mm)	1	TMCR-6464-NNNNC	C	7520.24	7583.74
70"(1778mm)		75"(1905mm)	1	TMCR-7070-NNNNC	C	7584.50	7648.00
Extended Range (Dual Stage)							
23"(584mm)/23"(584mm)	34"(864mm)	39"(991mm)	1	TMCR-3434-NNNNC	B	\$ 4061.12	\$ 4124.62
	40"(1016mm)	45"(1143mm)	1	TMCR-4040-NNNNC	B	4125.38	4188.88
	46"(1168mm)	51"(1295mm)	1	TMCR-4646-NNNNC	B	4189.64	4253.14
	52"(1321mm)	57"(1448mm)	1	TMCR-5252-NNNNC	B	10439.04	10502.54
	58"(1473mm)	63"(1600mm)	1	TMCR-5858-NNNNC	B	10503.30	10566.80
	64"(1626mm)	69"(1753mm)	1	TMCR-6464-NNNNC	B	10567.56	10631.06
	70"(1778mm)	75"(1905mm)	1	TMCR-7070-NNNNC	B	10631.82	10695.32
	29"(737mm)/29"(737mm)	52"(1321mm)	57"(1448mm)	1	TMCR-5252-NNNNC	C	\$10469.64
58"(1473mm)		63"(1600mm)	1	TMCR-5858-NNNNC	C	10533.90	10597.40
64"(1626mm)		69"(1753mm)	1	TMCR-6464-NNNNC	C	10598.16	10661.66
70"(1778mm)		75"(1905mm)	1	TMCR-7070-NNNNC	C	10662.42	10725.92

Planes Base for 90° Extended Corner Table

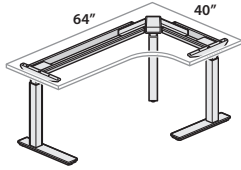

Electric Adjustment

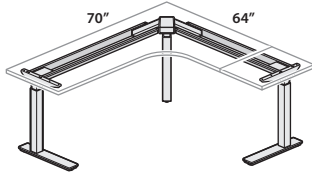

TMCE-4064-NCEB
(Left-hand Orientation)

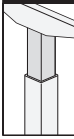

TMCE-6470-NCEE
(Left-hand Orientation)
Class TA - GSA; Open Market

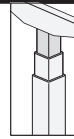
Touch Pads	Columns
 <p>Standard</p>	 <p>Standard Range (Single Stage) Height Adjustment 27.1" (689mm) to 46.0" (1169mm)</p>
 <p>Programmable (Height display will show in whole number format)</p>	 <p>Extended Range (Dual Stage) Height Adjustment</p> <p>Low: 22.4" (569mm) to 48.3" (1227mm)</p> <p>High: 23.3" (592mm) to 50.0" (1270mm)</p>

*Height range includes
1.18" (20mm) worksurface



Features

- Includes:
 - Two telescoping columns
 - One center post leg
 - Pair of steel feet (C-leg)
 - Fixed J-Rail frame system
 - Two End Brackets
 - Control Box
 - Standard or programmable touch pad switch
 - Wire management clips
 - Adjustable glides and hardware standard in black with 0.5"(13mm) of adjustment
 - 9'(2743mm) long black power cord with NEMA 5-15P Plug and 5'(1524mm) cable extension (with top width 52"(1321mm) or greater)
- Electric Height Adjustment:
 - Speed: 1.4"(36mm) per second
 - Standard Range (Single Stage) telescoping columns feature 18.9"(480mm) of continuous adjustment.
 - Extended Range (Dual Stage) telescoping columns feature a range of 25.9"(658mm) - 26.7"(678mm) of continuous adjustment.
- Telescoping inner columns default to matching or coordinating paint colors. See Finish pages for details.
- Ships unassembled.
- Depth and width shown in nominal dimension.

Specification Tips

- **Maximum work top width overhang allowed is 6"(152mm) on each side.**
- **Refer to specification guide for work surface weight.**
- Select a worksurface that accommodates 1"(25mm) of pinch point clearance on all sides and meets at least a NFPA class C flammability rating; refer to Specification Guide for application guidelines when surrounded by walls, panels or other worksurfaces.
- Total lifting capacity of table is 300 lbs including surface; applied weight should be evenly distributed.
- For use with attached Worktools (e.g. monitor arms, screens, storage, wire management, etc.), see Product Application guidelines.
- Not designed to be used with casters
- Application may require approval of local authority having jurisdiction (AHJ); ensure compliance before placing orders and installation.

To Order, Specify:

1) Product number, including:

1 Height Adjustment Actuator Options:

Standard Range
(Single Stage):

E Standard

R Programmable
(add **\$202.15** list)

Extended Range
(Dual Stage, Low):

P Standard

S Programmable
(add **\$202.15** list)

(Dual Stage, High):

Q Standard

T Programmable
(add **\$202.15** list)

2) Base trim color.

Planes Base for 90° Extended Corner Table

Electric Adjustment

Top Left/Right Depth	Minimum Top Width	Maximum Top Width	Length	Number	①	Trim A	B	
Standard Range (Single Stage)								
23"(584mm)/23"(584mm)	40"(1016mm)	51"(1295mm)	46"(1168mm)	TMCE-4046-NNNNC	B	\$ 5780.19	\$ 5843.69	
		57"(1448mm)	52"(1321mm)	TMCE-4052-NNNNC	B	5812.29	5875.79	
		63"(1600mm)	58"(1473mm)	TMCE-4058-NNNNC	B	5844.39	5907.89	
	46"(1168mm)	57"(1448mm)	69"(1753mm)	64"(1626mm)	TMCE-4064-NNNNC	B	5876.49	5939.99
			57"(1448mm)	52"(1321mm)	TMCE-4652-NNNNC	B	\$ 5844.39	\$ 5907.89
			63"(1600mm)	58"(1473mm)	TMCE-4658-NNNNC	B	5876.49	5939.99
		52"(1321mm)	69"(1753mm)	64"(1626mm)	TMCE-4664-NNNNC	B	5908.59	5972.09
			75"(1905mm)	70"(1778mm)	TMCE-4670-NNNNC	B	5940.69	6004.19
			63"(1600mm)	58"(1473mm)	TMCE-5258-NNNNC	B	\$ 5908.59	\$ 5972.09
	58"(1473mm)	69"(1753mm)	69"(1753mm)	64"(1626mm)	TMCE-5264-NNNNC	B	5940.69	6004.19
			75"(1905mm)	70"(1778mm)	TMCE-5270-NNNNC	B	5972.79	6036.29
			64"(1626mm)	70"(1778mm)	TMCE-5870-NNNNC	B	\$ 5972.79	\$ 6036.29
64"(1626mm)		69"(1753mm)	64"(1626mm)	TMCE-5864-NNNNC	B	6004.89	6068.39	
		75"(1905mm)	70"(1778mm)	TMCE-6470-NNNNC	B	\$ 6036.99	\$ 6100.49	
		69"(1753mm)	64"(1626mm)	TMCE-4652-NNNNC	C	\$ 5874.99	\$ 5938.49	
29"(737mm)/29"(737mm)	46"(1168mm)	63"(1600mm)	58"(1473mm)	TMCE-4658-NNNNC	C	5907.09	5970.59	
		69"(1753mm)	64"(1626mm)	TMCE-4664-NNNNC	C	5939.19	6002.69	
		75"(1905mm)	70"(1778mm)	TMCE-4670-NNNNC	C	5971.29	6034.79	
	52"(1321mm)	63"(1600mm)	58"(1473mm)	58"(1473mm)	TMCE-5258-NNNNC	C	\$ 5939.19	\$ 6002.69
			69"(1753mm)	64"(1626mm)	TMCE-5264-NNNNC	C	5971.29	6034.79
			75"(1905mm)	70"(1778mm)	TMCE-5270-NNNNC	C	6003.39	6066.89
		58"(1473mm)	69"(1753mm)	64"(1626mm)	TMCE-5864-NNNNC	C	\$ 6003.39	\$ 6066.89
			75"(1905mm)	70"(1778mm)	TMCE-5870-NNNNC	C	6035.49	6098.99
			64"(1626mm)	70"(1778mm)	TMCE-6470-NNNNC	C	\$ 6067.59	\$ 6131.09
	Extended Range (Dual Stage)							
	23"(584mm)/23"(584mm)	40"(1016mm)	51"(1295mm)	46"(1168mm)	TMCE-4046-NNNNC	B	\$ 7491.84	\$ 7555.34
			57"(1448mm)	52"(1321mm)	TMCE-4052-NNNNC	B	7523.94	7587.44
63"(1600mm)			58"(1473mm)	TMCE-4058-NNNNC	B	7556.04	7619.54	
46"(1168mm)		57"(1448mm)	69"(1753mm)	64"(1626mm)	TMCE-4064-NNNNC	B	7588.14	7651.64
			57"(1448mm)	52"(1321mm)	TMCE-4652-NNNNC	B	\$ 7556.04	\$ 7619.54
			63"(1600mm)	58"(1473mm)	TMCE-4658-NNNNC	B	7588.14	7651.64
		52"(1321mm)	69"(1753mm)	64"(1626mm)	TMCE-4664-NNNNC	B	7620.24	7683.74
			75"(1905mm)	70"(1778mm)	TMCE-4670-NNNNC	B	7652.34	7715.84
			63"(1600mm)	58"(1473mm)	TMCE-5258-NNNNC	B	\$ 7620.24	\$ 7683.74
58"(1473mm)		69"(1753mm)	69"(1753mm)	64"(1626mm)	TMCE-5264-NNNNC	B	7652.34	7715.84
			75"(1905mm)	70"(1778mm)	TMCE-5270-NNNNC	B	7684.44	7747.94
			64"(1626mm)	70"(1778mm)	TMCE-5870-NNNNC	B	\$ 7684.44	\$ 7747.94
	64"(1626mm)	69"(1753mm)	64"(1626mm)	TMCE-5864-NNNNC	B	7716.54	7780.04	
		75"(1905mm)	70"(1778mm)	TMCE-6470-NNNNC	B	\$ 7748.64	\$ 7812.14	
		69"(1753mm)	64"(1626mm)	TMCE-4652-NNNNC	C	\$ 7586.64	\$ 7650.14	
29"(737mm)/29"(737mm)	46"(1168mm)	63"(1600mm)	58"(1473mm)	TMCE-4658-NNNNC	C	7618.74	7682.24	
		69"(1753mm)	64"(1626mm)	TMCE-4664-NNNNC	C	7650.84	7714.34	
		75"(1905mm)	70"(1778mm)	TMCE-4670-NNNNC	C	7682.94	7746.44	
	52"(1321mm)	63"(1600mm)	58"(1473mm)	58"(1473mm)	TMCE-5258-NNNNC	C	\$ 7650.84	\$ 7714.34
			69"(1753mm)	64"(1626mm)	TMCE-5264-NNNNC	C	7682.94	7746.44
			75"(1905mm)	70"(1778mm)	TMCE-5270-NNNNC	C	7715.04	7778.54
		58"(1473mm)	69"(1753mm)	64"(1626mm)	TMCE-5864-NNNNC	C	\$ 7715.04	\$ 7778.54
			75"(1905mm)	70"(1778mm)	TMCE-5870-NNNNC	C	7747.14	7810.64
			64"(1626mm)	70"(1778mm)	TMCE-6470-NNNNC	C	\$ 7779.24	\$ 7842.74

Planes Base for 120° Corner Table

Electric Adjustment

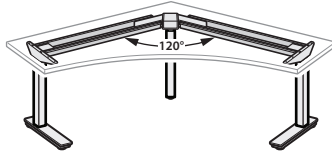

TMCZ-5858-NCEB
Class TA - GAS; Open Market

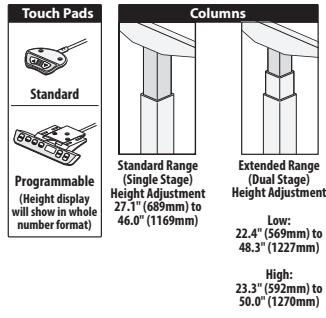

Features

- Includes:
 - Two telescoping columns
 - One center post leg
 - Pair of steel feet (C-leg)
 - Fixed J-Rail frame system
 - Two End Brackets
 - Control Box
 - Standard or programmable touch pad switch
 - Wire management clips
 - Adjustable glides and hardware standard in black with 0.5" (13mm) of adjustment
 - 9'(2743mm) long black power cord with NEMA 5-15P Plug and 5'(1524mm) cable extension (with top width 52"(1321mm) or greater)
- Electric Height Adjustment:
 - Speed: 1.4"(36mm) per second
 - Standard Range (Single Stage) telescoping columns feature 18.9"(480mm) of continuous adjustment.
 - Extended Range (Dual Stage) telescoping columns feature a range of 25.9"(658mm) - 26.7"(678mm) of continuous adjustment.
- Telescoping inner columns default to matching or coordinating paint colors. See Finish pages for details.
- Ships unassembled.
- Depth and width shown in nominal dimension.

Specification Tips

- **Maximum work top width overhang allowed is 6"(152mm) on each side.**
- **Refer to specification guide for work surface weight.**
- Select a work surface that accommodates 1"(25mm) of pinch point clearance on all sides and meets at least a NFPA class C flammability rating; refer to Specification Guide for application guidelines when surrounded by walls, panels or other work surfaces.
- Total lifting capacity of table is 300 lbs including surface; applied weight should be evenly distributed.
- For use with attached Worktools (e.g. monitor arms, screens, storage, wire management, etc.), see Product Application guidelines.
- Not designed to be used with casters
- Application may require approval of local authority having jurisdiction (AHJ); ensure compliance before placing orders and installation.

To Order, Specify:

- Product number, including:
 - 1) **Height Adjustment Actuator Options:**
 - Standard Range (Single Stage):
 - E** Standard
 - R** Programmable (add **\$202.15** list)
 - Extended Range (Dual Stage, Low):
 - P** Standard
 - S** Programmable (add **\$202.15** list)
 - (Dual Stage, High):
 - Q** Standard
 - T** Programmable (add **\$202.15** list)
 - 2) Base trim color.

Top Left/Right Depth	Minimum Top Width	Maximum Top Width	Length	Number	①	Trim	
						A	B
Standard Range (Single Stage)							
23"(584mm)/23"(584mm)	52"(1321mm)	57"(1448mm)	52"(1321mm)	TMCZ-5252-NNNNC	B	\$6068.04	\$ 6130.92
	58"(1473mm)	63"(1600mm)	58"(1473mm)	TMCZ-5858-NNNNC	B	6132.30	6195.18
29"(737mm)/29"(737mm)	52"(1321mm)	57"(1448mm)	52"(1321mm)	TMCZ-5252-NNNNC	C	\$6098.64	\$ 6161.52
	58"(1473mm)	63"(1600mm)	58"(1473mm)	TMCZ-5858-NNNNC	C	6162.90	6225.78
Extended Range (Dual Stage)							
23"(584mm)/23"(584mm)	52"(1321mm)	57"(1448mm)	52"(1321mm)	TMCZ-5252-NNNNC	B	\$ 7703.96	\$7766.84
	58"(1473mm)	63"(1600mm)	58"(1473mm)	TMCZ-5858-NNNNC	B	7768.22	7831.10
29"(737mm)/29"(737mm)	52"(1321mm)	57"(1448mm)	52"(1321mm)	TMCZ-5252-NNNNC	C	\$ 7734.56	\$ 7797.44
	58"(1473mm)	63"(1600mm)	58"(1473mm)	TMCZ-5858-NNNNC	C	7798.82	7861.70

Planes LT Table

Catalog Logic

TL RA - 23 46 - L J S N C E

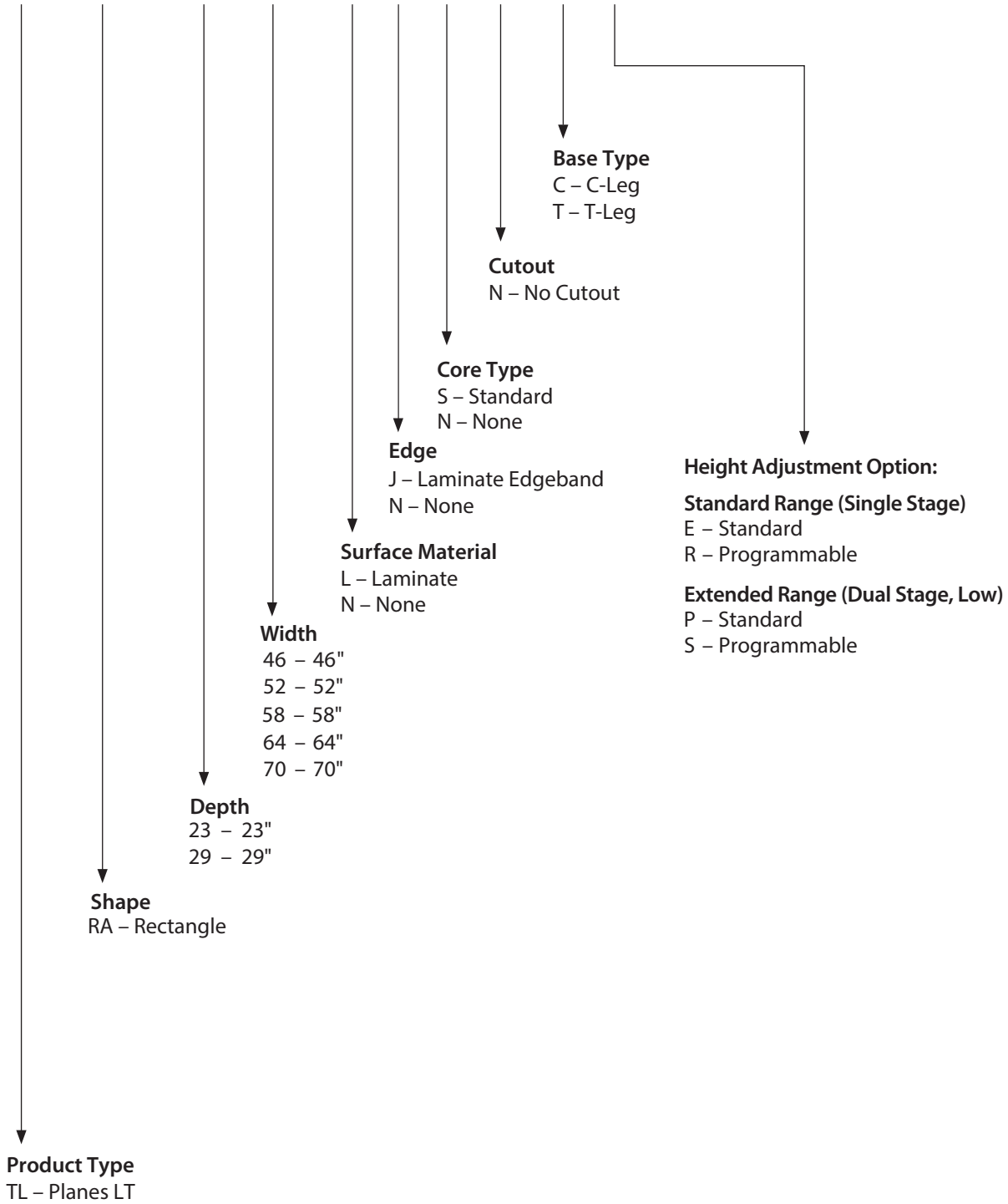

Planes LT Table — Rectangular

Electric Adjustment

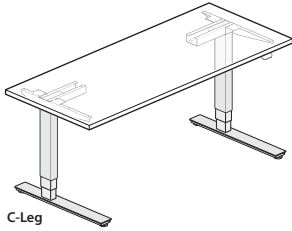

C-Leg

TLRA-2358-LJSNCP
Class TA

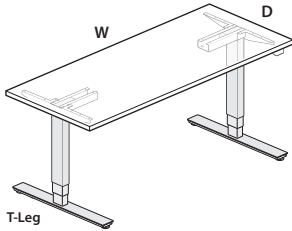

T-Leg

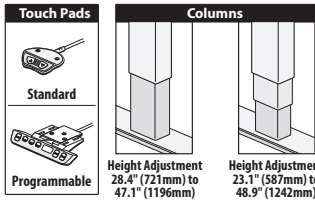

*Height range includes
1.18" (20mm) work surface



Features

- Includes:
 - 1.18"(30mm) thick work surface
 - Frameless C-leg and T-leg telescoping base assembly system
 - Standard or programmable touch pad switch
 - Wire management clips
 - Adjustable glides and hardware standard in black with 0.5"(13mm) of adjustment
 - 9'(2743mm) long black power cord with NEMA 5-15P Plug to the building
- Worksurface:
 - High-Pressure Laminate (HPL) worksurface with 3mm edgeband
- Optional Belong Hatch cutout:
 - High-Pressure Laminate (HPL) tops only with one cutout.
 - Available on worksurfaces 29"(737mm)D and widths 52"(1321mm), 58"(1473mm), 64"(1626mm) and 70"(1778mm).
 - Requires separately specified Belong Hatch.
 - Refer to Specification Guide for cutout details.
- Electric Height Adjustment:
 - Speed: 1.4"(36mm) per second
 - Standard Range (Single Stage) telescoping columns feature 18.7"(475mm) of continuous height adjustment.
 - Extended Range (Dual Stage) telescoping columns feature 25.8"(655mm) of continuous height adjustment.
- Base Assembly:
 - Telescoping inner columns default to matching or coordinating paint colors. See Finish pages for details.
 - Ships unassembled.
- Depth and width shown in nominal dimensions.

Specification Tips

- Worksurfaces are dimensioned to allow for pinch point clearance and cable accommodation; refer to Specification Guide for application guidelines when surrounded by walls, panels or other worksurfaces.
- Total lifting capacity of table is 250 lbs including surface; applied weight should be evenly distributed.
- For use with attached Worktools (e.g. monitor arms, screens, storage, wire management, etc.), see Product Application guidelines.
- Separately specified caster kit available.
- Application may require approval of local authority having jurisdiction (AHJ); ensure compliance before placing orders and installation.

To Order, Specify:

1) Product number, including:

1 Cutout Option:

- N** Without
- H** Belong Hatch

2 Base Option:

- C** C-leg
- T** T-leg

3 Height Adjustment Actuator Options:

Standard Range (Single Stage):

- E** Standard
- R** Programmable (add \$201.74 list)

Extended Range (Dual Stage):

- P** Standard
- S** Programmable (add \$201.74 list)

- 2) Laminate surface color.
- 3) Edge trim color.
- 4) Base trim color.

Note: \$59.95 upcharge list for Grade B trim colors.

Planes LT Table — Rectangular

Electric Adjustment

Depth	Width	Number	①②③	HPL		
				A	B	E
Standard Range (Single Stage)						
23"(584mm)	46"(1168mm)	TLRA-2346-LJSN	■ ■	\$2240.00	\$ 2288.98	\$ 2463.22
	52"(1321mm)	TLRA-2352-LJSN	■ ■	2274.22	2329.41	2525.99
	58"(1473mm)	TLRA-2358-LJSN	■ ■	2308.44	2369.84	2588.77
	64"(1626mm)	TLRA-2364-LJSN	■ ■	2342.66	2410.27	2651.55
	70"(1778mm)	TLRA-2370-LJSN	■ ■	2376.87	2450.69	2714.32
29"(737mm)	46"(1168mm)	TLRA-2946-LJSN	■ ■	\$ 2335.97	\$ 2397.37	\$ 2616.30
	52"(1321mm)	TLRA-2952-LJS	■ ■ ■	2378.78	2448.01	2695.12
	58"(1473mm)	TLRA-2958-LJS	■ ■ ■	2421.58	2498.64	2773.93
	64"(1626mm)	TLRA-2964-LJS	■ ■ ■	2464.39	2549.28	2852.75
	70"(1778mm)	TLRA-2970-LJS	■ ■ ■	2507.20	2599.92	2931.57
Extended Range (Dual Stage)						
23"(584mm)	46"(1168mm)	TLRA-2346-LJSN	■ ■	\$2643.49	\$ 2692.47	\$ 2866.71
	52"(1321mm)	TLRA-2352-LJSN	■ ■	2677.71	2732.90	2929.48
	58"(1473mm)	TLRA-2358-LJSN	■ ■	2711.93	2773.33	2992.26
	64"(1626mm)	TLRA-2364-LJSN	■ ■	2746.15	2813.76	3055.04
	70"(1778mm)	TLRA-2370-LJSN	■ ■	2780.36	2854.18	3117.81
29"(737mm)	46"(1168mm)	TLRA-2946-LJSN	■ ■	\$ 2739.46	\$2800.86	\$ 3019.79
	52"(1321mm)	TLRA-2952-LJS	■ ■ ■	2782.27	2851.50	3098.61
	58"(1473mm)	TLRA-2958-LJS	■ ■ ■	2825.07	2902.13	3177.42
	64"(1626mm)	TLRA-2964-LJS	■ ■ ■	2867.88	2952.77	3256.24
	70"(1778mm)	TLRA-2970-LJS	■ ■ ■	2910.69	3003.41	3335.06

Planes LT Table — Corners

Catalog Logic

TL CE - 46 46 - L J S N C E B

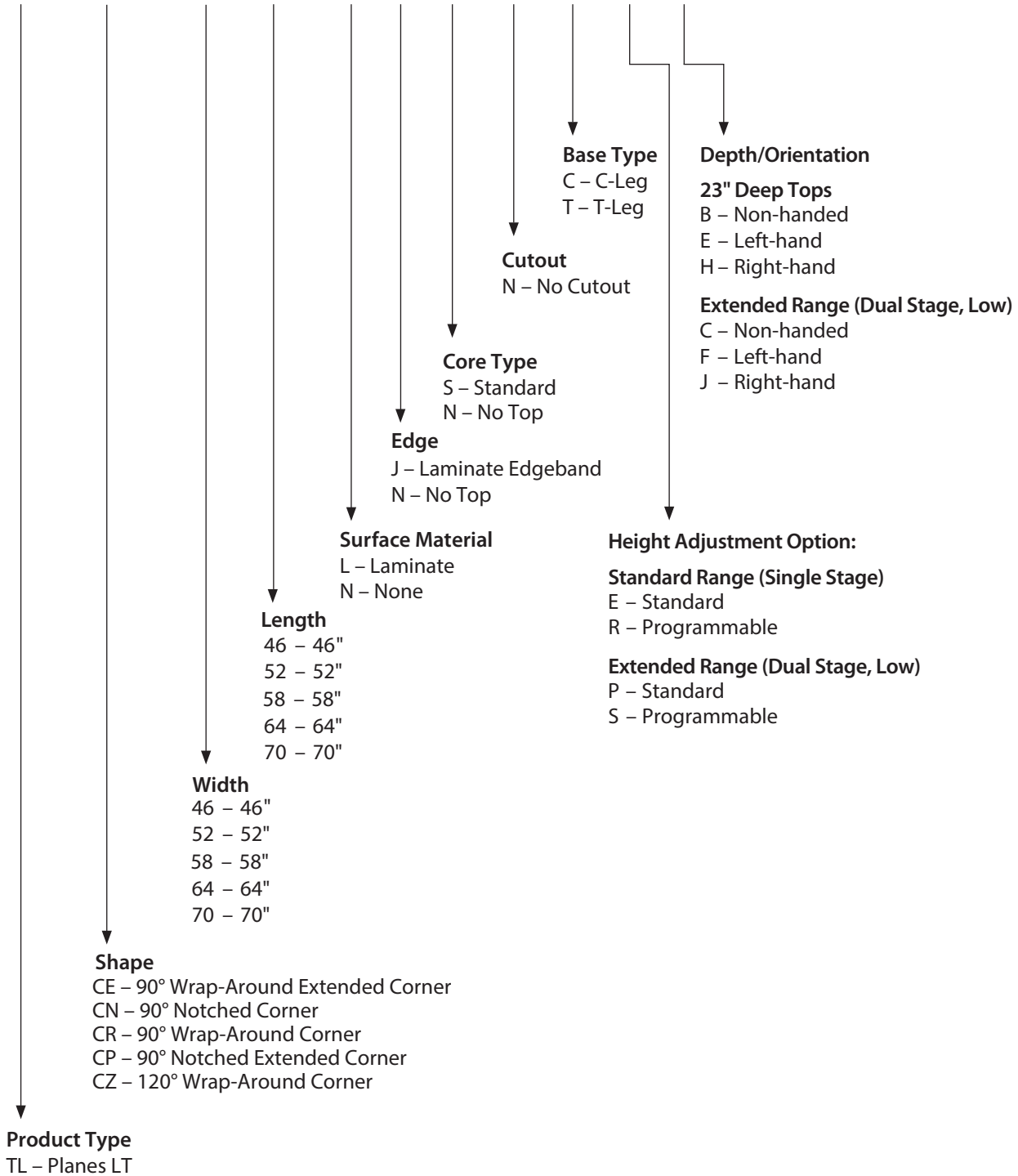

Planes LT Table — 90° Equal Corner — Notched

Electric Adjustment

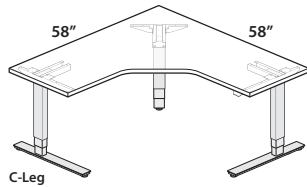

TLON-5858-LJSNCPB

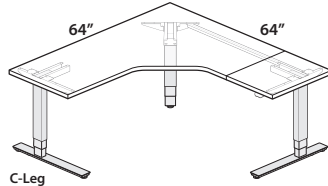

TLON-6464-LJSNCPB
(Left-hand Orientation)

Class TA

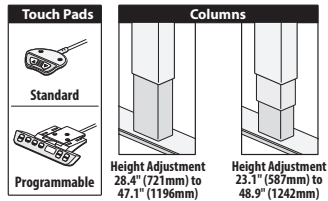

*Height range includes 1.18" (20mm) worksurface



Features

- Includes:
 - 1.18"(30mm) thick work surface
 - Frameless C-leg telescoping base assembly system
 - One center post leg
 - Standard or programmable touch pad switch
 - Wire management clips
 - Adjustable glides and hardware standard in black with 0.5"(13mm) of adjustment
 - 9'(2743mm) long black power cord with NEMA 5-15P plug and 5'(1524mm) cable extension (with top widths 52"(1321mm) or greater)
- Worksurface:
 - High-Pressure Laminate (HPL) worksurface with 3mm edgeband
 - 3mm Edgeband on user edge and 1mm on remaining edges
 - Size of worksurface will determine whether top comes in 1 or 2 pieces.
 - 64"(1626mm) wide and greater will default to 2 pieces.
 - 64"(1626mm) 2-piece top includes a 46"(1168mm) corner and 18"(457mm) rectangular top.
 - 70"(1778mm) includes a 52"(1321mm) corner and 18"(457mm) rectangular top.
 - Two-piece top includes L rail and connection plates.
- Electric Height Adjustment:
 - Speed: 1.4"(36mm) per second
 - Standard Range (Single Stage) telescoping columns feature 18.7"(475mm) of continuous height adjustment.
 - Extended Range (Dual Stage) telescoping columns feature 25.8"(655mm) of continuous height adjustment.
- Base Assembly:
 - Telescoping inner columns default to matching or coordinating paint colors. See Finish pages for details.
 - Ships unassembled.
- Depth and width shown in nominal dimensions.

Specification Tips

- Worksurfaces are dimensioned to allow for 2"(51mm) pinch point clearance and cable accommodation. (e.g. 58"(1473mm) corner may be space planned as a 60"(1524mm) corner for modular planning purposes.
- One-piece tops are non-handed; two-piece tops are handed.
- The "seamless" primary user side of the table (side without rectangle extension) determines the handedness from a seated position.
- Total lifting capacity of table is 300 lbs (3-leg) including surface; applied weight should be evenly distributed.
- For use with attached Worktools (e.g. monitor arms, screens, storage, wire management, etc.), see Product Application guidelines.
- Not designed for use with Casters.
- Application may require approval of local authority having jurisdiction (AHJ); ensure compliance before placing orders and installation.

To Order, Specify:

1) Product number, including:

1 Height Adjustment Actuator Options:

Standard Range (Single Stage):

- E** Standard
- R** Programmable (add \$201.74 list)

Extended Range (Dual Stage):

- P** Standard
- S** Programmable (add \$201.74 list)

2 Depth and Orientation:

23" deep tops:

- B** Non-handed (52" and 58" widths)
- E** LH (64" and 70" widths) two-piece top
- H** RH (64" and 70" widths) two-piece top

29" deep tops:

- C** Non-handed (52" and 58" widths)
- F** LH (64" and 70" widths) two-piece top
- J** RH (64" and 70" widths) two-piece top

2) Laminate surface color.

3) Edge trim color.

4) Base trim color.

Note: \$59.95 upcharge list for Grade B trim colors.

Planes LT Table — 90° Equal Corner — Notched

Electric Adjustment

Left/Right Depth	Width	Length	Top Pieces	Number	①②	HPL	
						A	B
Standard Range (Single Stage)							
23"(584mm)/23"(584mm)	52"(1321mm)	52"(1321mm)	1	TLCN-5252-LJSNC	B	\$ 3701.65	\$ 3836.65
	58"(1473mm)	58"(1473mm)	1	TLCN-5858-LJSNC	B	3782.95	3930.67
	64"(1626mm)	64"(1626mm)	2	TLCN-6464-LJSNC		4116.43	4276.87
	70"(1778mm)	70"(1778mm)	2	TLCN-7070-LJSNC		4197.73	4370.89
29"(737mm)/29"(737mm)	52"(1321mm)	52"(1321mm)	1	TLCN-5252-LJSNC	C	\$ 3751.78	\$ 3886.78
	58"(1473mm)	58"(1473mm)	1	TLCN-5858-LJSNC	C	3833.08	3980.80
	64"(1626mm)	64"(1626mm)	2	TLCN-6464-LJSNC		4166.56	4327.00
	70"(1778mm)	70"(1778mm)	2	TLCN-7070-LJSNC		4247.86	4421.02
Extended Range (Dual Stage)							
23"(584mm)/23"(584mm)	52"(1321mm)	52"(1321mm)	1	TLCN-5252-LJSNC	B	\$ 4161.33	\$ 4296.33
	58"(1473mm)	58"(1473mm)	1	TLCN-5858-LJSNC	B	4242.63	4390.35
	64"(1626mm)	64"(1626mm)	2	TLCN-6464-LJSNC		4576.11	4736.55
	70"(1778mm)	70"(1778mm)	2	TLCN-7070-LJSNC		4657.41	4830.57
29"(737mm)/29"(737mm)	52"(1321mm)	52"(1321mm)	1	TLCN-5252-LJSNC	C	\$ 4211.46	\$ 4346.46
	58"(1473mm)	58"(1473mm)	1	TLCN-5858-LJSNC	C	4292.76	4440.48
	64"(1626mm)	64"(1626mm)	2	TLCN-6464-LJSNC		4626.24	4786.68
	70"(1778mm)	70"(1778mm)	2	TLCN-7070-LJSNC		4707.54	4880.70

Planes LT Table — 90° Equal Corner — Wrap-Around Electric Adjustment

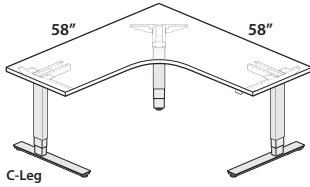

TLOR-6868-LJSNCPB

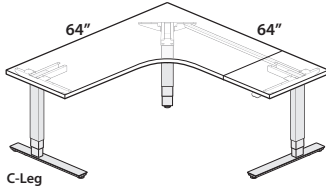

TLOR-6464-LJSNOPE
(Left-hand Orientation)

Class TA

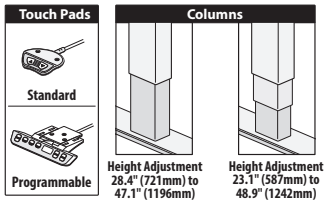

*Height range includes 1.18" (20mm) worksurface



Features

- Includes:
 - 1.18"(30mm) thick work surface
 - Frameless C-leg telescoping base assembly system
 - One center post leg
 - Standard or programmable touch pad switch
 - Wire management clips
 - Adjustable glides and hardware standard in black with 0.5"(13mm) of adjustment
 - 9'(2743mm) long black power cord with NEMA 5-15P plug and 5'(1524mm) cable extension (with top widths 52"(1321mm) or greater)
- Worksurface
 - High-Pressure Laminate (HPL) worksurface with 3mm edgeband
 - 3mm Edgeband on user edge and 1mm on remaining edges
 - Size of worksurface will determine whether top comes in 1 or 2 pieces. 64"(1626mm) wide and greater will default to 2 pieces.
 - 64"(1626mm)64"(1626mm) 2-piece top includes a 46"(1168mm) corner and 18"(457mm) rectangular top.
 - 70"(1778mm) includes a 52"(1321mm) corner and 18"(457mm) rectangular top.
 - Two-piece top includes L rail and connection plates.
- Electric Height Adjustment:
 - Speed: 1.4"(36mm) per second
 - Standard Range (Single Stage) telescoping columns feature 18.7"(475mm) of continuous height adjustment.
 - Extended Range (Dual Stage) telescoping columns feature 25.8"(655mm) of continuous height adjustment.
- Base Assembly:
 - Telescoping inner columns default to matching or coordinating paint colors. See Finish pages for details.
 - Ships unassembled.
- Depth and width shown in nominal dimensions.

Specification Tips

- Worksurfaces are dimensioned to allow for 2"(51mm) pinch point clearance and cable accommodation. (e.g. 58"(1473mm) corner may be space planned as a 60"(1524mm) corner for modular planning purposes.
- One-piece tops are non-handed; two-piece tops are handed.
- The "seamless" primary user side of the table (side without rectangle extension) determines the handedness from a seated position.
- Total lifting capacity of table is 300 lbs including surface; applied weight should be evenly distributed.
- For use with attached Worktools (e.g. monitor arms, screens, storage, wire management, etc.), see Product Application guidelines.
- Not designed for use with Casters.
- Application may require approval of local authority having jurisdiction (AHJ); ensure compliance before placing orders and installation.

To Order, Specify:

1) Product number, including:

1 Height Adjustment Actuator Options:

Standard Range (Single Stage):

- E** Standard
- R** Programmable (add \$201.74 list)

Extended Range (Dual Stage):

- P** Standard
- S** Programmable (add \$201.74 list)

2 Depth and Orientation:

23" deep tops:

- B** Non-handed (52" and 58" widths)
- E** LH (64" and 70" widths) two-piece top
- H** RH (64" and 70" widths) two-piece top

29" deep tops:

- C** Non-handed (52" and 58" widths)
- F** LH (64" and 70" widths) two-piece top
- J** RH (64" and 70" widths) two-piece top

2) Laminate surface color.

3) Edge trim color.

4) Base trim color.

Note: \$59.95 upcharge list for Grade B trim colors.

Planes LT Table — 90° Equal Corner — Wrap-Around

Electric Adjustment

Left/Right Depth	Width	Length	Top Pieces	Number	①②	HPL	
						A	B
Standard Range (Single Stage)							
23"(584mm)/23"(584mm)	52"(1321mm)	52"(1321mm)	1	TLCR-5252-LJSNC	B	\$3644.02	\$3779.02
	58"(1473mm)	58"(1473mm)	1	TLCR-5858-LJSNC	B	3725.32	3873.04
	64"(1626mm)	64"(1626mm)	2	TLCR-6464-LJSNC		4058.80	4219.24
	70"(1778mm)	70"(1778mm)	2	TLCR-7070-LJSNC		4140.10	4313.26
29"(737mm)/29"(737mm)	52"(1321mm)	52"(1321mm)	1	TLCR-5252-LJSNC	C	\$ 3694.15	\$ 3829.15
	58"(1473mm)	58"(1473mm)	1	TLCR-5858-LJSNC	C	3775.45	3923.17
	64"(1626mm)	64"(1626mm)	2	TLCR-6464-LJSNC		4108.93	4269.37
	70"(1778mm)	70"(1778mm)	2	TLCR-7070-LJSNC		4190.23	4363.39
Extended Range (Dual Stage)							
23"(584mm)/23"(584mm)	52"(1321mm)	52"(1321mm)	1	TLCR-5252-LJSNC	B	\$ 4103.70	\$4238.70
	58"(1473mm)	58"(1473mm)	1	TLCR-5858-LJSNC	B	4185.00	4332.72
	64"(1626mm)	64"(1626mm)	2	TLCR-6464-LJSNC		4518.48	4678.92
	70"(1778mm)	70"(1778mm)	2	TLCR-7070-LJSNC		4599.78	4772.94
29"(737mm)/29"(737mm)	52"(1321mm)	52"(1321mm)	1	TLCR-5252-LJSNC	C	\$ 4153.83	\$4288.83
	58"(1473mm)	58"(1473mm)	1	TLCR-5858-LJSNC	C	4235.13	4382.85
	64"(1626mm)	64"(1626mm)	2	TLCR-6464-LJSNC		4568.61	4729.05
	70"(1778mm)	70"(1778mm)	2	TLCR-7070-LJSNC		4649.91	4823.07

Planes LT Table — 90° Extended Corner — Notched Electric Adjustment

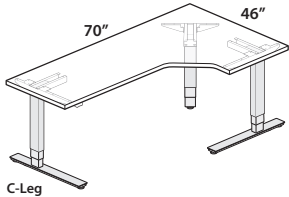

C-Leg

TLCP-4670-LJSNOPE
(Left-hand Orientation)

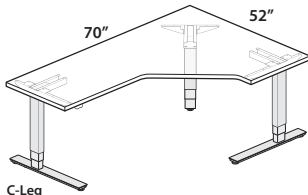

C-Leg

TLCP-5270-LJSNOPE
(Left-hand Orientation)
Class TA

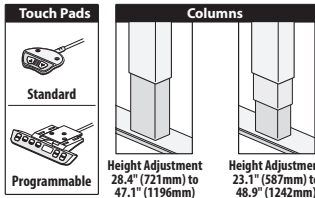

*Height range includes
1.18" (20mm) worksurface



Features

- Includes:
 - 1.18"(30mm) thick work surface
 - Frameless C-leg telescoping base assembly system
 - One center post leg
 - Standard or programmable touch pad switch
 - Wire management clips
 - Adjustable glides and hardware standard in black with 0.5"(13mm) of adjustment
 - 9'(2743mm) long black power cord with NEMA 5-15 plug and 5'(1524mm) cable extension (with top widths 52"(1321mm) or greater)
- Worksurface:
 - High-Pressure Laminate (HPL) worksurface with 3mm edgeband
 - 3mm Edgeband on user edge and 1mm on remaining edges
 - Top sizes 64"(1626mm) x 70"(1778mm) and larger will default to 2-pieces.
 - A 64"(1626mm) x 70"(1778mm) worksurface will include a 46"(1168mm) corner and 18"(457mm) rectangle extension.
 - Two-piece top includes L rail and connection plates.
- Electric Height Adjustment:
 - Speed: 1.4"(36mm) per second
 - Standard Range (Single Stage) telescoping columns feature 18.7"(475mm) of continuous height adjustment.
 - Extended Range (Dual Stage) telescoping columns feature 25.8"(655mm) of continuous height adjustment.
- Base Assembly:
 - Telescoping inner columns default to matching or coordinating paint colors. See Finish pages for details.
 - Ships unassembled.
- Depth and width shown in nominal dimensions.

Specification Tips

- Worksurfaces are dimensioned to allow for 2"(51mm) pinch point clearance and cable accommodation. (e.g. 58"(1473mm) corner may be space planned as a 60"(1524mm) corner for modular planning purposes.
- One-piece tops are non-handed; two-piece tops are handed.
- The "seamless" primary user side of the table (side without rectangle extension) determines the handedness from a seated position.
- Total lifting capacity of table is 300 lbs (3-leg) including surface; applied weight should be evenly distributed.
- For use with attached Worktools (e.g. monitor arms, screens, storage, wire management, etc.), see Product Application guidelines.
- Not designed for use with Casters.
- Application may require approval of local authority having jurisdiction (AHJ); ensure compliance before placing orders and installation.

To Order, Specify:

1) Product number, including:

1 Height Adjustment Actuator Options:

Standard Range (Single Stage):

- E** Standard
- R** Programmable (add \$201.74 list)

Extended Range (Dual Stage):

- P** Standard
- S** Programmable (add \$201.74 list)

2 Depth and Orientation:

23" deep tops:

- E** Left-hand
 - H** Right-hand
- 29" deep tops:
- F** Left-hand
 - J** Right-hand

- 2) Laminate surface color.
- 3) Edge trim color.
- 4) Base trim color.

Note: \$59.95 upcharge list for Grade B trim colors.

Planes LT Table — 90° Extended Corner — Notched

Electric Adjustment

Left/Right Depth	Width	Length	Top Pieces	Number	①②	HPL		
						A	B	
Standard Range (Single Stage)								
23"(584mm)/23"(584mm)	46"(1168mm)	52"(1321mm)	1	TLCP-4652-LJSNC	■ ■	\$ 3661.00	\$ 3789.64	
		58"(1473mm)	1	TLCP-4658-LJSNC	■ ■	3701.65	3836.65	
		64"(1626mm)	1	TLCP-4664-LJSNC	■ ■	3742.30	3883.66	
		70"(1778mm)	1	TLCP-4670-LJSNC	■ ■	3782.95	3930.67	
	52"(1321mm)	58"(1473mm)	1	TLCP-5258-LJSNC	■ ■	\$ 3742.30	\$ 3883.66	
		64"(1626mm)	1	TLCP-5264-LJSNC	■ ■	3782.95	3930.67	
		70"(1778mm)	1	TLCP-5270-LJSNC	■ ■	3823.60	3977.68	
	58"(1473mm)	64"(1626mm)	1	TLCP-5864-LJSNC	■ ■	\$ 3823.60	\$ 3977.68	
		70"(1778mm)	1	TLCP-5870-LJSNC	■ ■	3864.25	4024.69	
		64"(1626mm)	70"(1778mm)	2	TLCP-6470-LJSNC	■ ■	\$ 4157.08	\$ 4323.88
	29"(737mm)/29"(737mm)	46"(1168mm)	52"(1321mm)	1	TLCP-4652-LJSNC	■ ■	\$ 3711.13	\$ 3839.77
			58"(1473mm)	1	TLCP-4658-LJSNC	■ ■	3751.78	3886.78
64"(1626mm)			1	TLCP-4664-LJSNC	■ ■	3792.43	3933.79	
70"(1778mm)			1	TLCP-4670-LJSNC	■ ■	3833.08	3980.80	
52"(1321mm)		58"(1473mm)	1	TLCP-5258-LJSNC	■ ■	\$ 3792.43	\$ 3933.79	
		64"(1626mm)	1	TLCP-5264-LJSNC	■ ■	3833.08	3980.80	
		70"(1778mm)	1	TLCP-5270-LJSNC	■ ■	3873.73	4027.81	
58"(1473mm)		64"(1626mm)	1	TLCP-5864-LJSNC	■ ■	\$ 3873.73	\$ 4027.81	
		70"(1778mm)	1	TLCP-5870-LJSNC	■ ■	3914.38	4074.82	
		64"(1626mm)	70"(1778mm)	2	TLCP-6470-LJSNC	■ ■	\$ 4207.21	\$ 4374.01
Extended Range (Dual Stage)								
23"(584mm)/23"(584mm)		46"(1168mm)	52"(1321mm)	1	TLCP-4652-LJSNC	■ ■	\$ 4120.68	\$ 4249.32
	58"(1473mm)		1	TLCP-4658-LJSNC	■ ■	4161.33	4296.33	
	64"(1626mm)		1	TLCP-4664-LJSNC	■ ■	4201.98	4343.34	
	70"(1778mm)		1	TLCP-4670-LJSNC	■ ■	4242.63	4390.35	
	52"(1321mm)	58"(1473mm)	1	TLCP-5258-LJSNC	■ ■	\$ 4201.98	\$ 4343.34	
		64"(1626mm)	1	TLCP-5264-LJSNC	■ ■	4242.63	4390.35	
		70"(1778mm)	1	TLCP-5270-LJSNC	■ ■	4283.28	4437.36	
	58"(1473mm)	64"(1626mm)	1	TLCP-5864-LJSNC	■ ■	\$ 4283.28	\$ 4437.36	
		70"(1778mm)	1	TLCP-5870-LJSNC	■ ■	4323.93	4484.37	
		64"(1626mm)	70"(1778mm)	2	TLCP-6470-LJSNC	■ ■	\$ 4616.76	\$ 4783.56
	29"(737mm)/29"(737mm)	46"(1168mm)	52"(1321mm)	1	TLCP-4652-LJSNC	■ ■	\$ 4170.81	\$ 4299.45
			58"(1473mm)	1	TLCP-4658-LJSNC	■ ■	4211.46	4346.46
64"(1626mm)			1	TLCP-4664-LJSNC	■ ■	4252.11	4393.47	
70"(1778mm)			1	TLCP-4670-LJSNC	■ ■	4292.76	4440.48	
52"(1321mm)		58"(1473mm)	1	TLCP-5258-LJSNC	■ ■	\$ 4252.11	\$ 4393.47	
		64"(1626mm)	1	TLCP-5264-LJSNC	■ ■	4292.76	4440.48	
		70"(1778mm)	1	TLCP-5270-LJSNC	■ ■	4333.41	4487.49	
58"(1473mm)		64"(1626mm)	1	TLCP-5864-LJSNC	■ ■	\$ 4333.41	\$ 4487.49	
		70"(1778mm)	1	TLCP-5870-LJSNC	■ ■	4374.06	4534.50	
		64"(1626mm)	70"(1778mm)	2	TLCP-6470-LJSNC	■ ■	\$4666.89	\$ 4833.69

Planes LT Table — 90° Extended Corner — Wrap-Around Electric Adjustment

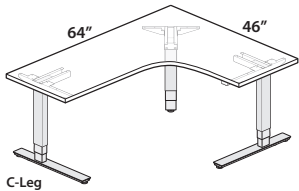

TLCE-4664-LJSNOPE
(Left-hand Orientation)

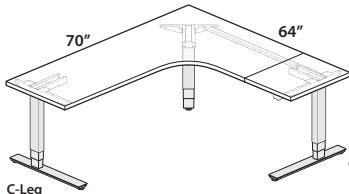

TLCE-6470-LJSNOPE
(Left-hand Orientation)
Class TA

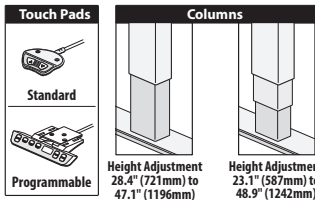

*Height range includes 1.18" (20mm) worksurface



Features

- Includes:
 - 1.18"(30mm) thick work surface
 - Frameless C-leg telescoping base assembly system
 - One center post leg
 - Standard or programmable touch pad switch
 - Wire management clips
 - Adjustable glides and hardware standard in black with 0.5"(13mm) of adjustment
 - 9'(2743mm) long black power cord with NEMA 5-15P plug and 5'(1524mm) cable extension (with top widths 52"(1321mm) or greater)
- Worksurface:
 - High-Pressure Laminate (HPL) worksurface with 3mm edgeband
 - 3mm Edgeband on user edge and 1mm on remaining edges
 - Top sizes 64"(1626mm) x and larger will default to 2-pieces.
 - A 64"(1626mm) x 70"(1778mm) worksurface will include a 46"(1168mm) corner and 18"(457mm) rectangle extension.
 - Two-piece top includes L rail and connection plates.
- Electric Height Adjustment:
 - Speed: 1.4"(36mm) per second.
 - Standard Range (Single Stage) telescoping columns feature 18.7"(475mm) of continuous height adjustment.
 - Extended Range (Dual Stage) telescoping columns feature 25.8"(655mm) of continuous height adjustment.
- Base Assembly:
 - Telescoping inner columns default to matching or coordinating paint colors. See Finish pages for details.
 - Ships unassembled.
- Depth and width shown in nominal dimensions.

Specification Tips

- Worksurfaces are dimensioned to allow for 2"(51mm) pinch point clearance and cable accommodation. (e.g. 58"(1473mm) corner may be space planned as a 60"(1524mm) corner for modular planning purposes.
- One-piece tops are non-handed; two-piece tops are handed.
- The "seamless" primary user side of the table (side without rectangle extension) determines the handedness from a seated position.
- Total lifting capacity of table is 300 lbs (3-leg) including surface; applied weight should be evenly distributed.
- For use with attached Worktools (e.g. monitor arms, screens, storage, wire management, etc.), see Product Application guidelines.
- Not designed for use with Casters.
- Application may require approval of local authority having jurisdiction (AHJ); ensure compliance before placing orders and installation.

To Order, Specify:

1) Product number, including:

1 Height Adjustment Actuator Options:

Standard Range (Single Stage):

- E** Standard
- R** Programmable (add \$201.74 list)

Extended Range (Dual Stage):

- P** Standard
- S** Programmable (add \$201.74 list)

2 Depth and Orientation:

23" deep tops:

- E** Left-hand
 - H** Right-hand
- 29" deep tops:
- F** Left-hand
 - J** Right-hand

- 2) Laminate surface color.
- 3) Edge trim color.
- 4) Base trim color.

Note: \$59.95 upcharge list for Grade B trim colors.

Planes LT Table — 90° Extended Corner — Wrap-Around Electric Adjustment

Left/Right Depth	Width	Length	Top Pieces	Number	①②	HPL		
						A	B	
Standard Range (Single Stage)								
23"(584mm)/23"(584mm)	46"(1168mm)	52"(1321mm)	1	TLCE-4652-LJSNC	■ ■	\$ 3603.37	\$ 3732.01	
		58"(1473mm)	1	TLCE-4658-LJSNC	■ ■	3644.02	3779.02	
		64"(1626mm)	1	TLCE-4664-LJSNC	■ ■	3684.67	3826.03	
		70"(1778mm)	1	TLCE-4670-LJSNC	■ ■	3725.32	3873.04	
	52"(1321mm)	58"(1473mm)	1	TLCE-5258-LJSNC	■ ■	\$ 3684.67	\$ 3826.03	
		64"(1626mm)	1	TLCE-5264-LJSNC	■ ■	3725.32	3873.04	
		70"(1778mm)	1	TLCE-5270-LJSNC	■ ■	3765.97	3920.05	
	58"(1473mm)	64"(1626mm)	1	TLCE-5864-LJSNC	■ ■	\$ 3765.97	\$ 3920.05	
		70"(1778mm)	1	TLCE-5870-LJSNC	■ ■	3806.62	3967.06	
		64"(1626mm)	70"(1778mm)	2	TLCE-6470-LJSNC	■ ■	\$ 4099.45	\$ 4266.25
	29"(737mm)/29"(737mm)	46"(1168mm)	52"(1321mm)	1	TLCE-4652-LJSNC	■ ■	\$ 3653.50	\$ 3782.14
			58"(1473mm)	1	TLCE-4658-LJSNC	■ ■	3694.15	3829.15
64"(1626mm)			1	TLCE-4664-LJSNC	■ ■	3734.80	3876.16	
70"(1778mm)			1	TLCE-4670-LJSNC	■ ■	3775.45	3923.17	
52"(1321mm)		58"(1473mm)	1	TLCE-5258-LJSNC	■ ■	\$ 3734.80	\$ 3876.16	
		64"(1626mm)	1	TLCE-5264-LJSNC	■ ■	3775.45	3923.17	
		70"(1778mm)	1	TLCE-5270-LJSNC	■ ■	3816.10	3970.18	
58"(1473mm)		64"(1626mm)	1	TLCE-5864-LJSNC	■ ■	\$ 3816.10	\$ 3970.18	
		70"(1778mm)	1	TLCE-5870-LJSNC	■ ■	3856.75	4017.19	
		64"(1626mm)	70"(1778mm)	2	TLCE-6470-LJSNC	■ ■	\$ 4149.58	\$ 4316.38
Extended Range (Dual Stage)								
23"(584mm)/23"(584mm)		46"(1168mm)	52"(1321mm)	1	TLCE-4652-LJSNC	■ ■	\$ 4063.05	\$ 4191.69
	58"(1473mm)		1	TLCE-4658-LJSNC	■ ■	4103.70	4238.70	
	64"(1626mm)		1	TLCE-4664-LJSNC	■ ■	4144.35	4285.71	
	70"(1778mm)		1	TLCE-4670-LJSNC	■ ■	4185.00	4332.72	
	52"(1321mm)	58"(1473mm)	1	TLCE-5258-LJSNC	■ ■	\$ 4144.35	\$ 4285.71	
		64"(1626mm)	1	TLCE-5264-LJSNC	■ ■	4185.00	4332.72	
		70"(1778mm)	1	TLCE-5270-LJSNC	■ ■	4225.65	4379.73	
	58"(1473mm)	64"(1626mm)	1	TLCE-5864-LJSNC	■ ■	\$ 4225.65	\$ 4379.73	
		70"(1778mm)	1	TLCE-5870-LJSNC	■ ■	4266.30	4426.74	
		64"(1626mm)	70"(1778mm)	2	TLCE-6470-LJSNC	■ ■	\$ 4559.13	\$ 4725.93
	29"(737mm)/29"(737mm)	46"(1168mm)	52"(1321mm)	1	TLCE-4652-LJSNC	■ ■	\$ 4113.18	\$ 4241.82
			58"(1473mm)	1	TLCE-4658-LJSNC	■ ■	4153.83	4288.83
64"(1626mm)			1	TLCE-4664-LJSNC	■ ■	4194.48	4335.84	
70"(1778mm)			1	TLCE-4670-LJSNC	■ ■	4235.13	4382.85	
52"(1321mm)		58"(1473mm)	1	TLCE-5258-LJSNC	■ ■	\$ 4194.48	\$ 4335.84	
		64"(1626mm)	1	TLCE-5264-LJSNC	■ ■	4235.13	4382.85	
		70"(1778mm)	1	TLCE-5270-LJSNC	■ ■	4275.78	4429.86	
58"(1473mm)		64"(1626mm)	1	TLCE-5864-LJSNC	■ ■	\$ 4275.78	\$ 4429.86	
		70"(1778mm)	1	TLCE-5870-LJSNC	■ ■	4316.43	4476.87	
		64"(1626mm)	70"(1778mm)	2	TLCE-6470-LJSNC	■ ■	\$ 4609.26	\$ 4776.06

Planes LT Table — 120° Corner — Wrap-Around

Electric Adjustment

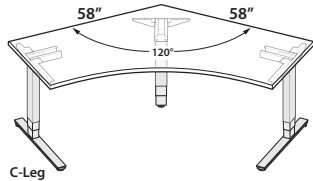

C-Leg
TLCZ-5858-LJSNCPB
Class TA

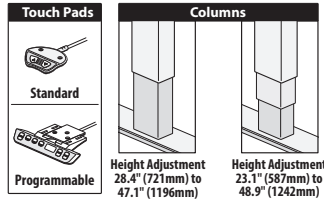

*Height range includes 1.18" (20mm) work surface



Features

- Includes:
 - 1.18"(30mm) thick work surface
 - Frameless C-leg telescoping base assembly system
 - One center post leg
 - Standard or programmable touch pad switch
 - Wire management clips
 - Adjustable glides and hardware standard in black with 0.5"(13mm) of adjustment
 - 9'(2743mm) long black power cord with NEMA 5-15P plug and 5'(1524mm) cable extension (with top widths 52"(1321mm) or greater)
- Worksurface
 - High-Pressure Laminate (HPL) worksurface with 3mm edgeband
 - 3mm Edgeband on user edge and 1mm on remaining edges
- Electric Height Adjustment:
 - Speed: 1.4"(36mm) per second
 - Standard Range (Single Stage) telescoping columns feature 18.7"(475mm) of continuous height adjustment.
 - Extended Range (Dual Stage) telescoping columns feature 25.8"(655mm) of continuous height adjustment.
- Base Assembly:
 - Telescoping inner columns default to matching or coordinating paint colors. See Finish pages for details.
 - Ships unassembled.
- Depth and width shown in nominal dimensions.

Specification Tips

- Worksurfaces are dimensioned to allow for 2"(51mm) pinch point clearance and cable accommodation. (e.g. 58"(1473mm) corner may be space planned as a 60"(1524mm) corner for modular planning purposes.
- Total lifting capacity of table is 300 lbs including surface; applied weight should be evenly distributed.
- For use with attached Worktools (e.g. monitor arms, screens, storage, wire management, etc.), see Product Application guidelines.
- Not design for use with casters.
- Application may require approval of local authority having jurisdiction (AHJ); ensure compliance before placing orders and installation.

To Order, Specify:

1) Product number, including:

① Height Adjustment Actuator Options:

Standard Range (Single Stage):

- E** Standard
- R** Programmable (add **\$201.74** list)

Extended Range (Dual Stage):

- P** Standard
- S** Programmable (add **\$201.74** list)

- 2) Laminate surface color.
- 3) Edge trim color.
- 4) Base trim color.

Note: **\$59.95** upcharge list for Grade B trim colors.

Left/Right Depth	Width	Length	Top Pieces	Number	①	HPL	
						A	B
Standard Range (Single Stage)							
23"(584mm)/23"(584mm)	46"(1168mm)	46"(1168mm)	1	TLCZ-4646-LJSNC	B	\$3995.00	\$ 4117.28
	52"(1321mm)	52"(1321mm)	1	TLCZ-5252-LJSNC	B	4076.30	4211.30
	58"(1473mm)	58"(1473mm)	1	TLCZ-5858-LJSNC	B	4157.60	4305.32
29"(737mm)/29"(737mm)	46"(1168mm)	46"(1168mm)		TLCZ-4646-LJSNC	C	\$ 4045.13	\$ 4167.41
	52"(1321mm)	52"(1321mm)	1	TLCZ-5252-LJSNC	C	4126.43	4261.43
	58"(1473mm)	58"(1473mm)	1	TLCZ-5858-LJSNC	C	4207.73	4355.45
Extended Range (Dual Stage)							
23"(584mm)/23"(584mm)	46"(1168mm)	46"(1168mm)		TLCZ-4646-LJSNC	B	\$4454.68	\$4576.96
	52"(1321mm)	52"(1321mm)	1	TLCZ-5252-LJSNC	B	4535.98	4670.98
	58"(1473mm)	58"(1473mm)	1	TLCZ-5858-LJSNC	B	4617.28	4765.00
29"(737mm)/29"(737mm)	46"(1168mm)	46"(1168mm)		TLCZ-4646-LJSNC	C	\$ 4504.81	\$4627.09
	52"(1321mm)	52"(1321mm)	1	TLCZ-5252-LJSNC	C	4586.11	4721.11
	58"(1473mm)	58"(1473mm)	1	TLCZ-5858-LJSNC	C	4667.41	4815.13

Planes LT Base for Rectangular Table

Electric Adjustment

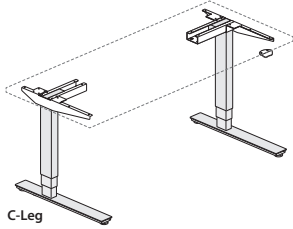

C-Leg

TLRA-2946-NNNNCP

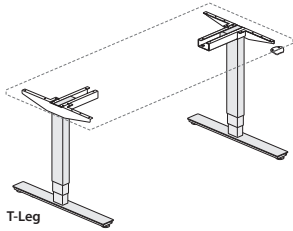

T-Leg

TLRA-2946-NNNNT

Class TA

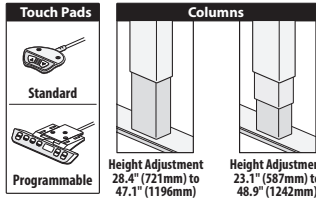

*Height range includes
1.18" (20mm) work surface



Features

- Includes:
 - Two telescoping columns with steel motor housing enclosure
 - Pair of steel feet (C-leg or T-leg)
 - Two End Brackets
 - Control Box
 - Standard or programmable touch pad switch
 - Wire management clips
 - Adjustable glides and hardware standard in black with 0.5" (13mm) of adjustment
 - 9' (2743mm) long black power cord with NEMA 5-15P Plug to the building
- Electric Height Adjustment:
 - Speed: 1.4" (36mm) per second
 - Standard Range (Single Stage) telescoping columns feature 18.7" (475mm) of continuous height adjustment.
 - Extended Range (Dual Stage) telescoping columns feature 25.8" (655mm) of continuous height adjustment.
- Base Assembly:
 - Telescoping inner columns default to matching or coordinating paint colors. See Finish pages for details.
 - Ships unassembled.

Specification Tips

- **Maximum work top width overhang allowed is 6" (152mm) on each side.**
- **Refer to specification guide for work surface weight.**
- Select a worksurface that accommodates 1" (25mm) of pinch point clearance on all sides and meets at least a NFPA class C flammability rating; refer to Specification Guide for application guidelines when surrounded by walls, panels or other worksurfaces.
- Total lifting capacity of table is 250 lbs including surface; applied weight should be evenly distributed.
- For applications using attached worktools (monitor arms, screens, storage, wire management, etc.), see Product Application guidelines.
- Separately specified caster kit available.
- Base Only Application may require approval of local authority having jurisdiction (AHJ); ensure compliance before placing orders and installation.

To Order, Specify:

1) Product number, including:

1 Base Options:

C C-leg

T T-leg

2 Height Adjustment Options:

Standard Range (Single Stage):

E Standard

R Programmable
(add **\$201.74** list)

Extended Range (Dual Stage):

P Standard

S Programmable
(add **\$201.74** list)

2) Base trim color.

Planes LT Base for Rectangular Table

Electric Adjustment

Depth	Minimum Top Width	Maximum Top Width	Number	①②	Trim A	B
Standard Range (Single Stage)						
23"(584mm)	46"(1168mm)	51"(1295mm)	TLRA-2346-NNNN	■ ■	\$ 1972.71	\$2032.66
	52"(1321mm)	57"(1448mm)	TLRA-2352-NNNN	■ ■	1972.71	2032.66
	58"(1473mm)	63"(1600mm)	TLRA-2358-NNNN	■ ■	1972.71	2032.66
	64"(1626mm)	69"(1753mm)	TLRA-2364-NNNN	■ ■	1972.71	2032.66
	70"(1778mm)	75"(1905mm)	TLRA-2370-NNNN	■ ■	1972.71	2032.66
29"(737mm)	46"(1168mm)	51"(1295mm)	TLRA-2946-NNNN	■ ■	\$ 2001.53	\$ 2061.48
	52"(1321mm)	57"(1448mm)	TLRA-2952-NNNN	■ ■	2001.53	2061.48
	58"(1473mm)	63"(1600mm)	TLRA-2958-NNNN	■ ■	2001.53	2061.48
	64"(1626mm)	69"(1753mm)	TLRA-2964-NNNN	■ ■	2001.53	2061.48
	70"(1778mm)	75"(1905mm)	TLRA-2970-NNNN	■ ■	2001.53	2061.48
Extended Range (Dual Stage)						
23"(584mm)	46"(1168mm)	51"(1295mm)	TLRA-2346-NNNN	■ ■	\$2376.20	\$ 2436.15
	52"(1321mm)	57"(1448mm)	TLRA-2352-NNNN	■ ■	2376.20	2436.15
	58"(1473mm)	63"(1600mm)	TLRA-2358-NNNN	■ ■	2376.20	2436.15
	64"(1626mm)	69"(1753mm)	TLRA-2364-NNNN	■ ■	2376.20	2436.15
	70"(1778mm)	75"(1905mm)	TLRA-2370-NNNN	■ ■	2376.20	2436.15
29"(737mm)	46"(1168mm)	51"(1295mm)	TLRA-2946-NNNN	■ ■	\$2405.02	\$2464.97
	52"(1321mm)	57"(1448mm)	TLRA-2952-NNNN	■ ■	2405.02	2464.97
	58"(1473mm)	63"(1600mm)	TLRA-2958-NNNN	■ ■	2405.02	2464.97
	64"(1626mm)	69"(1753mm)	TLRA-2964-NNNN	■ ■	2405.02	2464.97
	70"(1778mm)	75"(1905mm)	TLRA-2970-NNNN	■ ■	2405.02	2464.97

Planes LT Base for 90° Equal Corner Table

Electric Adjustment

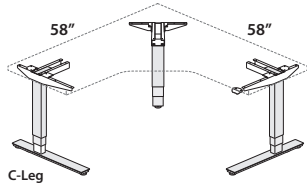

TLOR-6868-NNNNCPB

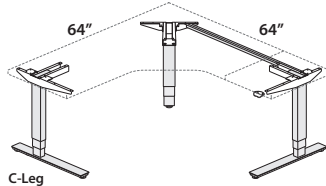

TLOR-6464-NNNNCPB
(Left-hand Orientation)

Class TA

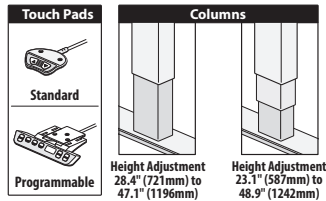

*Height range includes 1.18" (20mm) worksurface



Features

- Includes:
 - Two telescoping columns with steel motor housing enclosure
 - One center post leg with steel motor housing enclosure
 - Pair of steel feet (C-leg)
 - Three End Brackets
 - Control Box
 - Standard or programmable touch pad switch
 - Wire management clips
 - Adjustable glides and hardware standard in black with 0.5"(0mm) of adjustment
 - 9'(2743mm) long black power cord with NEMA 5-15P Plug to the building and 5'(1524mm) cable extension (with top widths 52"(1321mm) or greater)
- Electric Height Adjustment:
 - Speed: 1.4"(36mm) per second
 - Standard Range (Single Stage) telescoping columns feature 18.7"(475mm) of continuous height adjustment.
 - Extended Range (Dual Stage) telescoping columns feature 25.8"(655mm) of continuous height adjustment.
- Base Assembly:
 - Telescoping inner columns default to matching or coordinating paint colors. See Finish pages for details.
 - Ships unassembled.

Specification Tips

- **Maximum work top width overhang allowed is 6"(152mm) on each side.**
- **Refer to specification guide for work surface weight.**
- Select a worksurface that accommodates 1"(25mm) of pinch point clearance on all sides and meets at least a NFPA class C flammability rating; refer to Specification Guide for application guidelines when surrounded by walls, panels or other worksurfaces.
- Total lifting capacity of table is 300 lbs including surface; applied weight should be evenly distributed.
- For use with attached Worktools (e.g. monitor arms, screens, storage, wire management, etc.), see Product Application guidelines.
- Not designed to be used with casters.
- Application may require approval of local authority having jurisdiction (AHJ); ensure compliance before placing orders and installation.

To Order, Specify:

1) Product number, including:

1 Height Adjustment Options:
Standard Range (Single Stage):

E Standard

R Programmable
(add **\$201.74** list)

Extended Range (Dual Stage):

P Standard

S Programmable
(add **\$201.74** list)

2) Base trim color.

Planes LT Base for 90° Equal Corner Table

Electric Adjustment

Top Left/Right Depth	Minimum Top Width	Maximum Top Width	Number	①	Trim A	B
Standard Range (Single Stage)						
23"(584mm)/23"(584mm)	52"(1321mm)	57"(1448mm)	TLCR-5252-NNNNC	B	\$ 2929.53	\$2989.48
	58"(1473mm)	63"(1600mm)	TLCR-5858-NNNNC	B	2929.53	2989.48
	64"(1626mm)	69"(1753mm)	TLCR-6464-NNNNC	B	3181.71	3241.66
	70"(1778mm)	75"(1905mm)	TLCR-7070-NNNNC	B	3181.71	3241.66
29"(737mm)/29"(737mm)	52"(1321mm)	57"(1448mm)	TLCR-5252-NNNNC	C	\$ 2977.08	\$3037.03
	58"(1473mm)	63"(1600mm)	TLCR-5858-NNNNC	C	2977.08	3037.03
	64"(1626mm)	69"(1753mm)	TLCR-6464-NNNNC	C	3229.26	3289.21
	70"(1778mm)	75"(1905mm)	TLCR-7070-NNNNC	C	3229.26	3289.21
Extended Range (Dual Stage)						
23"(584mm)/23"(584mm)	52"(1321mm)	57"(1448mm)	TLCR-5252-NNNNC	B	\$ 3389.21	\$ 3449.16
	58"(1473mm)	63"(1600mm)	TLCR-5858-NNNNC	B	3389.21	3449.16
	64"(1626mm)	69"(1753mm)	TLCR-6464-NNNNC	B	3641.39	3701.34
	70"(1778mm)	75"(1905mm)	TLCR-7070-NNNNC	B	3641.39	3701.34
29"(737mm)/29"(737mm)	52"(1321mm)	57"(1448mm)	TLCR-5252-NNNNC	C	\$ 3436.76	\$ 3496.71
	58"(1473mm)	63"(1600mm)	TLCR-5858-NNNNC	C	3436.76	3496.71
	64"(1626mm)	69"(1753mm)	TLCR-6464-NNNNC	C	3688.94	3748.89
	70"(1778mm)	75"(1905mm)	TLCR-7070-NNNNC	C	3688.94	3748.89

Planes LT Base for 90° Extended Corner Table

Electric Adjustment

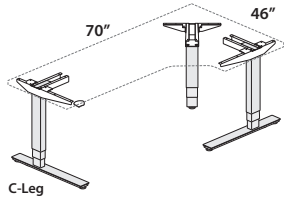

TLCE-4670-NNNNCPB
(Left-hand Orientation)

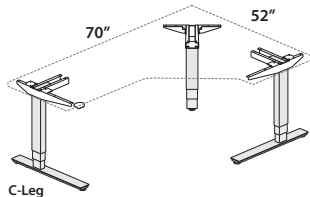

TLCE-5270-NNNNCPB
(Left-hand Orientation)
Class TA

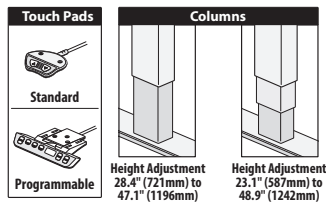

Height Adjustment
28.4" (721mm) to
47.1" (1196mm)

Height Adjustment
23.1" (587mm) to
48.9" (1242mm)

*Height range includes
1.18" (20mm) work surface



Features

- Includes:
 - Two telescoping columns with steel motor housing enclosure
 - One center post leg with steel motor housing enclosure
 - Pair of steel feet
 - Three End Brackets
 - Control Box
 - Standard or programmable touch pad switch
 - Wire management clips
 - Adjustable glides and hardware standard in black with 0.5"(13mm) of adjustment
 - 9'(2743mm) long black power cord with NEMA 5-15P Plug to the building and 5'(1524mm) cable extension (with top widths 52"(1321mm) or greater)
- Electric Height Adjustment:
 - Speed: 1.4"(36mm) per second
 - Standard Range (Single Stage) telescoping columns feature 18.7"(475mm) of continuous height adjustment.
 - Extended Range (Dual Stage) telescoping columns feature 25.8"(655mm) of continuous height adjustment.
- Base Assembly:
 - Telescoping inner columns default to matching or coordinating paint colors. See Finish pages for details.
 - Ships unassembled.

Specification Tips

- **Maximum work top width overhang allowed is 6"(152mm) on each side.**
- **Refer to specification guide for work surface weight.**
- Select a worksurface that accommodates 1"(25mm) of pinch point clearance on all sides and meets at least a NFPA class C flammability rating; refer to Specification Guide for application guidelines when surrounded by walls, panels or other worksurfaces.
- Total lifting capacity of table is 300 lbs including surface; applied weight should be evenly distributed.
- For use with attached Worktools (e.g. monitor arms, screens, storage, wire management, etc.), see Product Application guidelines.
- Not designed to be used with casters.
- Application may require approval of local authority having jurisdiction (AHJ); ensure compliance before placing orders and installation.

To Order, Specify:

1) Product number, including:

1 Height Adjustment Options:
Standard Range (Single Stage):

- E** Standard
- R** Programmable
(add **\$201.74** list)

Extended Range (Dual Stage):

- P** Standard
- S** Programmable
(add **\$201.74** list)

2) Base trim color.

Planes LT Base for 90° Extended Corner Table

Electric Adjustment

Left/Right Depth	Minimum Top Width	Maximum Top Width	Length	Number	①	Trim A	B		
Standard Range (Single Stage)									
23"(584mm)/23"(584mm)	46"(1168mm)	57"(1448mm)	52"(1321mm)	TLCE-4652-NNNNC	B	\$ 2929.53	\$2989.48		
		63"(1600mm)	58"(1473mm)	TLCE-4658-NNNNC	B	2929.53	2989.48		
		69"(1753mm)	64"(1626mm)	TLCE-4664-NNNNC	B	2929.53	2989.48		
		75"(1905mm)	70"(1778mm)	TLCE-4670-NNNNC	B	2929.53	2989.48		
	52"(1321mm)	63"(1600mm)	58"(1473mm)	TLCE-5258-NNNNC	B	\$ 2929.53	\$2989.48		
		69"(1753mm)	64"(1626mm)	TLCE-5264-NNNNC	B	2929.53	2989.48		
		75"(1905mm)	70"(1778mm)	TLCE-5270-NNNNC	B	2929.53	2989.48		
		58"(1473mm)	69"(1753mm)	64"(1626mm)	TLCE-5864-NNNNC	B	\$ 2929.53	\$2989.48	
	64"(1626mm)	75"(1905mm)	70"(1778mm)	TLCE-5870-NNNNC	B	2929.53	2989.48		
		75"(1905mm)	70"(1778mm)	TLCE-6470-NNNNC	B	\$ 3181.71	\$ 3241.66		
		29"(737mm)/29"(737mm)	46"(1168mm)	57"(1448mm)	52"(1321mm)	TLCE-4652-NNNNC	C	\$ 2977.08	\$3037.03
				63"(1600mm)	58"(1473mm)	TLCE-4658-NNNNC	C	2977.08	3037.03
69"(1753mm)	64"(1626mm)			TLCE-4664-NNNNC	C	2977.08	3037.03		
75"(1905mm)	70"(1778mm)			TLCE-4670-NNNNC	C	2977.08	3037.03		
52"(1321mm)	63"(1600mm)		58"(1473mm)	TLCE-5258-NNNNC	C	\$ 2977.08	\$3037.03		
	69"(1753mm)		64"(1626mm)	TLCE-5264-NNNNC	C	2977.08	3037.03		
	75"(1905mm)		70"(1778mm)	TLCE-5270-NNNNC	C	2977.08	3037.03		
	58"(1473mm)		69"(1753mm)	64"(1626mm)	TLCE-5864-NNNNC	C	\$ 2977.08	\$3037.03	
64"(1626mm)	75"(1905mm)		70"(1778mm)	TLCE-5870-NNNNC	C	2977.08	3037.03		
	75"(1905mm)		70"(1778mm)	TLCE-6470-NNNNC	C	\$ 3229.26	\$ 3289.21		
	Extended Range (Dual Stage)								
	23"(584mm)/23"(584mm)		46"(1168mm)	57"(1448mm)	52"(1321mm)	TLCE-4652-NNNNC	B	\$ 3389.21	\$ 3449.16
63"(1600mm)		58"(1473mm)		TLCE-4658-NNNNC	B	3389.21	3449.16		
69"(1753mm)		64"(1626mm)		TLCE-4664-NNNNC	B	3389.21	3449.16		
75"(1905mm)		70"(1778mm)		TLCE-4670-NNNNC	B	3389.21	3449.16		
52"(1321mm)		63"(1600mm)	58"(1473mm)	TLCE-5258-NNNNC	B	\$ 3389.21	\$ 3449.16		
		69"(1753mm)	64"(1626mm)	TLCE-5264-NNNNC	B	3389.21	3449.16		
		75"(1905mm)	64"(1626mm)	TLCE-5270-NNNNC	B	3389.21	3449.16		
		58"(1473mm)	69"(1753mm)	64"(1626mm)	TLCE-5864-NNNNC	B	\$ 3389.21	\$ 3449.16	
64"(1626mm)		75"(1905mm)	70"(1778mm)	TLCE-5870-NNNNC	B	3389.21	3449.16		
		75"(1905mm)	70"(1778mm)	TLCE-6470-NNNNC	B	\$ 3641.39	\$ 3701.34		
		29"(737mm)/29"(737mm)	46"(1168mm)	57"(1448mm)	52"(1321mm)	TLCE-4652-NNNNC	C	\$ 3436.76	\$ 3496.71
				63"(1600mm)	58"(1473mm)	TLCE-4658-NNNNC	C	3436.76	3496.71
69"(1753mm)	64"(1626mm)			TLCE-4664-NNNNC	C	3436.76	3496.71		
75"(1905mm)	70"(1778mm)			TLCE-4670-NNNNC	C	3436.76	3496.71		
52"(1321mm)	63"(1600mm)		58"(1473mm)	TLCE-5258-NNNNC	C	\$ 3436.76	\$ 3496.71		
	69"(1753mm)		64"(1626mm)	TLCE-5264-NNNNC	C	3436.76	3496.71		
	75"(1905mm)		70"(1778mm)	TLCE-5270-NNNNC	C	3436.76	3496.71		
	58"(1473mm)		69"(1753mm)	70"(1778mm)	TLCE-5864-NNNNC	C	\$ 3436.76	\$ 3496.71	
64"(1626mm)	75"(1905mm)		70"(1778mm)	TLCE-5870-NNNNC	C	3436.76	3496.71		
	75"(1905mm)		70"(1778mm)	TLCE-6470-NNNNC	C	\$ 3688.94	\$ 3748.89		

Planes LT Base for 120° Corner Table

Electric Adjustment

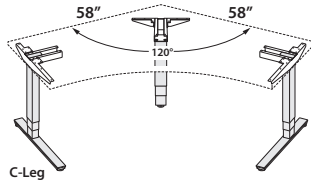

TLCZ-5858-NNNNCPB
Class TA

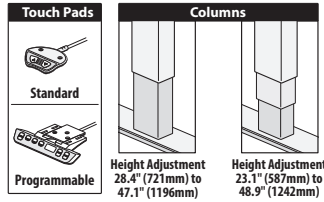

*Height range includes 1.18" (20mm) worksurface



Features

- Includes:
 - Two telescoping columns with steel motor housing enclosure
 - One center post leg with steel motor housing enclosure
 - Pair of steel feet (C-leg)
 - Three End Brackets
 - Standard or programmable touch pad switch
 - Wire management clips
 - Adjustable glides and hardware standard in black with 0.5" (13mm) of adjustment
 - 9' (2743mm) long black power cord with NEMA 5-15P Plug to the building and 5' (1524mm) cable extension (with top widths 52" (1321mm) or greater)
- Electric Height Adjustment:
 - Standard Range (Single Stage) telescoping columns feature 18.7" (475mm) of continuous height adjustment.
 - Extended Range (Dual Stage) telescoping columns feature 25.8" (655mm) of continuous height adjustment.
- Base Assembly:
 - Telescoping inner columns default to matching or coordinating paint colors. See Finish pages for details.
 - Ships unassembled.

Specification Tips

- **Maximum work top width overhang allowed is 6" (152mm) on each side.**
- **Refer to specification guide for work surface weight.**
- Select a worksurface that accommodates 1" (25mm) of pinch point clearance on all sides and meets at least a NFPA class C flammability rating; refer to Specification Guide for application guidelines when surrounded by walls, panels or other worksurfaces.
- Total lifting capacity of table is 300 lbs including surface; applied weight should be evenly distributed.
- For use with attached Worktools (e.g. monitor arms, screens, storage, wire management, etc.), see Product Application guidelines.
- Not designed to be used with casters.
- Application may require approval of local authority having jurisdiction (AHJ); ensure compliance before placing orders and installation.

To Order, Specify:

1) Product number, including:

1 Height Adjustment Options:

Standard Range (Single Stage):

E Standard

R Programmable
(add **\$201.74** list)

Extended Range (Dual Stage):

P Standard

S Programmable
(add **\$201.74** list)

2) Base trim color.

Note: \$56.03 upcharge list for Grade B trim colors.

Left/Right Depth	Minimum Top Width	Maximum Top Width	Length	Number	①	Price
Standard Range (Single Stage)						
23"(584mm)/23"(584mm)	46"(1168mm)	46"(1168mm)	46"(1168mm)	TLCZ-4646-NNNNC	B	\$2929.53
	52"(1321mm)	57"(1448mm)	52"(1321mm)	TLCZ-5252-NNNNC	B	2929.53
	58"(1473mm)	63"(1600mm)	58"(1473mm)	TLCZ-5858-NNNNC	B	2929.53
29"(737mm)/29"(737mm)	46"(1168mm)	46"(1168mm)	46"(1168mm)	TLCZ-4646-NNNNC	C	\$2977.08
	52"(1321mm)	57"(1448mm)	52"(1321mm)	TLCZ-5252-NNNNC	C	2977.08
	58"(1473mm)	63"(1600mm)	58"(1473mm)	TLCZ-5858-NNNNC	C	2977.08
Extended Range (Dual Stage)						
23"(584mm)/23"(584mm)	46"(1168mm)	46"(1168mm)	46"(1168mm)	TLCZ-4646-NNNNC	B	\$ 3389.21
	52"(1321mm)	57"(1448mm)	52"(1321mm)	TLCZ-5252-NNNNC	B	3389.21
	58"(1473mm)	63"(1600mm)	58"(1473mm)	TLCZ-5858-NNNNC	B	3389.21
29"(737mm)/29"(737mm)	46"(1168mm)	46"(1168mm)	46"(1168mm)	TLCZ-4646-NNNNC	C	\$3436.76
	52"(1321mm)	57"(1448mm)	52"(1321mm)	TLCZ-5252-NNNNC	C	3436.76
	58"(1473mm)	63"(1600mm)	58"(1473mm)	TLCZ-5858-NNNNC	C	3436.76

Upside Table

Catalog Logic

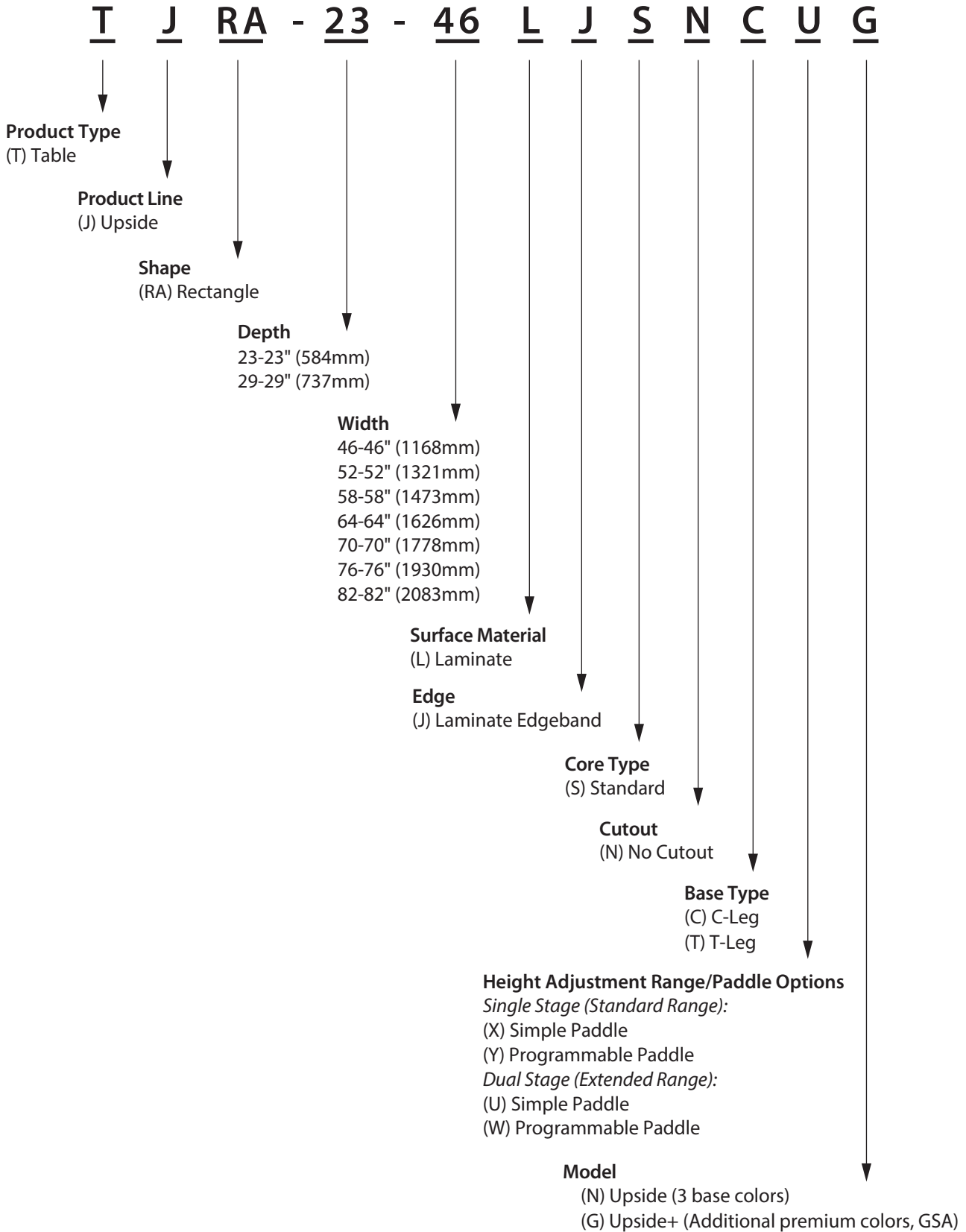

Upside Table — Rectangular

Electric Adjustment

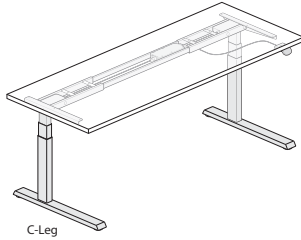

C-Leg

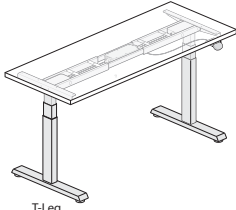

T-Leg

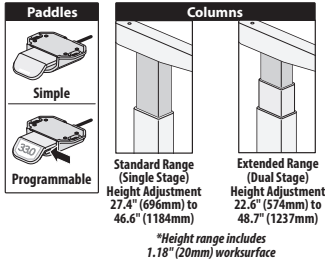

TJRA
Upside Class US – GSA: Open Market
Upside+ Class US



Features

- Includes:
 - 1.18"(30mm) thick high-pressure laminate (HPL) top.
 - C-leg or T-leg telescoping base assembly.
 - Simple or programmable paddle.
 - Wire management clips.
 - Adjustable glides and hardware.
- High-Pressure Laminate (HPL) top with 3mm edgeband edge on user side and 1mm on remaining edges.
- Optional Belong Hatch cutout:
 - High-Pressure Laminate (HPL) tops only with one cutout.
 - Available on worksurfaces 29"(737mm)D and widths 58"(1473mm), 64"(1626mm), 70"(1778mm), 76"(1930mm) and 82"(2083mm).
 - Requires separately specified Belong Hatch.
 - Refer to Specification Guide for cutout details.
- Electric Height adjustment:
 - Speed is 1.4"(25mm) per second.
 - Standard Range (Single Stage) telescoping columns feature 19.2"(488mm) continuous adjustment range.
 - Extended Range (Dual Stage) telescoping columns feature a 26.1"(663mm) continuous adjustment range.
- Base Assembly:
 - Telescoping inner columns are standard with matching or coordinating paint colors. See Finish pages for details.
 - Available in three standard colors.
 - Additional premium colors available with Upside+ specification.
 - Ships unassembled.
- Depth and width shown in nominal dimensions.

Specification Tips

- Maximum work top overhang allowed is 12"(305mm) overhang on one or both sides of the frame legs. *(Do not mount suspended storage to the overhang).*
- See Product Application pages for guidelines on pinch points when Height Adjustable Table is surrounded by walls, panels and/or other worksurfaces.
- Total lifting capacity of table is 250 lbs. including surface; applied weight should be evenly distributed.
- Refer to Specification Guide/Product Application for guidelines to attach monitor arms, screens and other worktools.
- Separately specified caster kit available. See Specification Guide for application.
- Application may require approval of local authority having jurisdiction (AHJ); ensure compliance before placing orders and installation.

To Order, Specify:

1) Product number, including:

1 Cutout Option:

- N Without
- H Belong Hatch

2 Height Adjustment Range/ Paddle Options:

Standard Range (Single Stage):

- X Simple
- Y Programmable (add **\$99.17** list)

Extended Range (Dual Stage):

- U Simple
- W Programmable (add **\$99.17** list)

3 Model (colors):

- N Upside (3 base colors) ^(M)
- G Upside+ (additional premium colors, GSA), add **\$297.51** list)

2) Laminate surface color.

3) Edge trim color.

4) Base trim color.

Note: \$55.00 upcharge list for Grade B trim colors.

^(M) Items marked with this symbol available as GSA open market.

Upside Table — Rectangular

Electric Adjustment

Depth	Width	Number	①②③④	HPL		
				A	B	E
Standard Range (Single Stage)						
23"(584mm)	46"(1168mm)	TJRA-2346-LJSN	■ ■ ■	\$1362.22	\$ 1381.71	\$1439.07
	52"(1321mm)	TJRA-2352-LJSN	■ ■ ■	1395.40	1416.87	1480.11
	58"(1473mm)	TJRA-2358-LJSN	■ ■ ■	1428.58	1452.03	1521.15
	64"(1626mm)	TJRA-2364-LJSN	■ ■ ■	1461.76	1487.19	1562.19
	70"(1778mm)	TJRA-2370-LJSN	■ ■ ■	1494.94	1522.35	1603.23
	76"(1930mm)	TJRA-2376-LJSN	■ ■ ■	1528.12	1557.51	1644.27
	82"(2083mm)	TJRA-2382-LJSN	■ ■ ■	1561.30	1592.67	1685.31
29"(737mm)	46"(1168mm)	TJRA-2946-LJSN	■ ■ ■	\$ 1415.11	\$1434.60	\$ 1491.96
	52"(1321mm)	TJRA-2952-LJSN	■ ■ ■	1448.29	1469.76	1533.00
	58"(1473mm)	TJRA-2958-LJS	■ ■ ■	1481.47	1504.92	1574.04
	64"(1626mm)	TJRA-2964-LJS	■ ■ ■	1514.65	1540.08	1615.08
	70"(1778mm)	TJRA-2970-LJS	■ ■ ■	1547.83	1575.24	1656.12
	76"(1930mm)	TJRA-2976-LJS	■ ■ ■	1581.01	1610.40	1697.16
	82"(2083mm)	TJRA-2982-LJS	■ ■ ■	1614.19	1645.56	1738.20
Extended Range (Dual Stage)						
23"(584mm)	46"(1168mm)	TJRA-2346-LJSN	■ ■ ■	\$ 1531.42	\$ 1550.91	\$1608.27
	52"(1321mm)	TJRA-2352-LJSN	■ ■ ■	1564.60	1586.07	1649.31
	58"(1473mm)	TJRA-2358-LJSN	■ ■ ■	1597.78	1621.23	1690.35
	64"(1626mm)	TJRA-2364-LJSN	■ ■ ■	1630.96	1656.39	1731.39
	70"(1778mm)	TJRA-2370-LJSN	■ ■ ■	1664.14	1691.55	1772.43
	76"(1930mm)	TJRA-2376-LJSN	■ ■ ■	1697.32	1726.71	1813.47
	82"(2083mm)	TJRA-2382-LJSN	■ ■ ■	1730.50	1761.87	1854.51
29"(737mm)	46"(1168mm)	TJRA-2946-LJSN	■ ■ ■	\$ 1584.31	\$1603.80	\$ 1661.16
	52"(1321mm)	TJRA-2952-LJSN	■ ■ ■	1617.49	1638.96	1702.20
	58"(1473mm)	TJRA-2958-LJS	■ ■ ■	1650.67	1674.12	1743.24
	64"(1626mm)	TJRA-2964-LJS	■ ■ ■	1683.85	1709.28	1784.28
	70"(1778mm)	TJRA-2970-LJS	■ ■ ■	1717.03	1744.44	1825.32
	76"(1930mm)	TJRA-2976-LJS	■ ■ ■	1750.21	1779.60	1866.36
	82"(2083mm)	TJRA-2982-LJS	■ ■ ■	1783.39	1814.76	1907.40

Upside Base for Rectangular Table

Electric

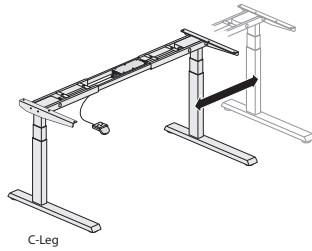

C-Leg

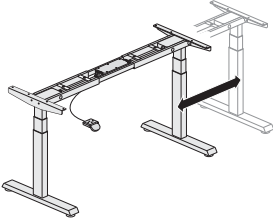

T-Leg

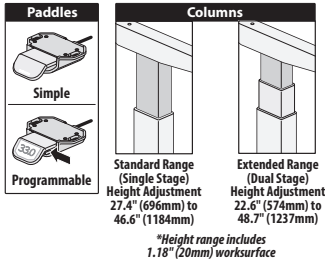

Features

- Includes:
 - Control box containing built-in collision detection system.
 - Two telescoping columns.
 - Simple or Programmable adjustment paddle.
 - Expandable frame (40.18"(1021mm) to 71.7"(1821mm)).
 - End brackets.
 - Flat steel feet (T or C) with mitered edge.
 - Adjustable glides and hardware standard in black with 0.5"(13mm) of adjustment.
 - 9'(2743mm) long black power cord with NEMA 5-15P plug.
- Electric Height adjustment:
 - Speed is 1.4"(36mm) per second.
 - Standard Range (Single Stage) telescoping columns feature 19.2"(488mm) continuous adjustment range.
 - Extended Range (Dual Stage) telescoping columns feature 26.1"(663mm) continuous adjustment range.
- Available in three standard colors.
- Additional premium colors available with Upside+ specification.
- Telescoping inner columns will default to matching or coordinating paint finish based on specified trim color. See Finish pages for details.
- Depth and width shown in nominal dimensions.
- Ships unassembled.

Specification Tips

- Base can support worksurface sizes from 22"(559mm) to 30"(762mm) in depth and 46"(1168mm) to 94"(2388mm) in width.
- Maximum work top overhang allowed is 12"(305mm) on one or both sides of the frame legs.
- When attaching suspended storage to work surface, do not mount to overhang.
- Total lifting capacity of table is 250 lbs. including surface; applied weight should be evenly distributed.
- Select a work surface that accommodates 1"(25mm) pinch point clearance on all sides and meets at least a NFPA class C flammability rating.
- See Product Application pages for guidelines on pinch points when Height Adjustable Table is surrounded by walls, panels and/or other worksurfaces.
- Application may require approval of local authority having jurisdiction (AHJ); ensure compliance before placing orders and installation.
- Refer to Specification Guide/Product Application for guidelines to attach monitor arms, screens and other worktools.

To Order, Specify:

1) Product number, including:

1 Model (colors):

N Upside (3 base colors) **(M)**

G Upside+ (additional premium colors, GSA) (add **\$297.51** list)

2) Base trim color.

Note: \$55.00 upcharge list for Grade B trim colors.

(M) Items marked with this symbol available as GSA open market.

TJBA
Upside Class US – GSA: Open Market
Upside+ Class US



Upside Base for Rectangular Table

Electric

Description	Depth	Number ①	Trim A
2-Leg Base			
Standard Range (Single Stage) – Simple Paddle			
T Base	23"(584mm)	TJBA-2TXB-■	\$ 1143.74
	29"(737mm)	TJBA-2TXC-■	1143.74
C Base	23"(584mm)	TJBA-2CXB-■	\$ 1143.74
	29"(737mm)	TJBA-2CXC-■	1143.74
Standard Range (Single Stage) – Programmable Paddle			
T Base	23"(584mm)	TJBA-2TYB-■	\$ 1242.91
	29"(737mm)	TJBA-2TYC-■	1242.91
C Base	23"(584mm)	TJBA-2CYB-■	\$ 1242.91
	29"(737mm)	TJBA-2CYC-■	1242.91
Extended Range (Dual Stage) – Simple Paddle			
T Base	23"(584mm)	TJBA-2TUB-■	\$1295.80
	29"(737mm)	TJBA-2TUC-■	1295.80
C Base	23"(584mm)	TJBA-2CUB-■	\$1295.80
	29"(737mm)	TJBA-2CUC-■	1295.80
Extended Range (Dual Stage) – Programmable Paddle			
T Base	23"(584mm)	TJBA-2TWB-■	\$1394.96
	29"(737mm)	TJBA-2TWC-■	1394.96
C Base	23"(584mm)	TJBA-2CWB-■	\$1394.96
	29"(737mm)	TJBA-2CWC-■	1394.96

Upside Base for 90° or 120° Table

Electric Adjustment

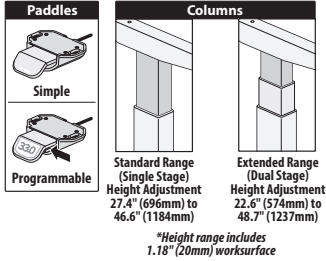
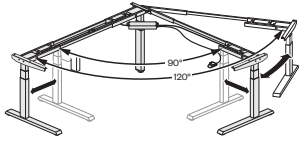

TJBA-3CXB-G
Upside Class US - GSA: Open Market
Upside- Class US



Features

- Includes:
 - Two C-leg telescoping columns with 23"(584mm)D feet.
 - One center post leg.
 - Expandable frame system.
 - Two End brackets.
 - Control box with built-in collision detection system.
 - Simple or Programmable paddle adjustment.
 - Wire management clips.
 - Adjustable glides standard in black (0.5"(13mm) adjustment range).
 - 9'(2743mm) long black power cord with NEMA 5-15P plug and 5'(1524mm) cable extension.
- Electric Height adjustment:
 - Speed is 1.5"(38mm) per second.
 - Standard Range (Single Stage) telescoping columns feature 19.2"(488mm) continuous adjustment range.
 - Extended Range (Dual Stage) telescoping columns feature a 26.1"(663mm) continuous adjustment range.
- Available in a variety of paint trim colors.
- Telescoping inner columns will default to matching or coordinating paint finish based on specified trim color. See Finish pages for details.
- Depth shown in nominal dimensions.
- Ships unassembled.

Specification Tips

- Base can support corner worksurface sizes from 23"(584mm) to 29"(737mm) in depth and 46"(1168mm) to 88"(2235mm) in width per side.

Note: Total area of surface must not exceed 3741 inches.

- Maximum work top overhang allowed is 6"(152mm).
- Not designed to be used with casters.
- Total lifting capacity of table is 330 lbs. including surface; applied weight should be evenly distributed.
- Select any corner worksurface from the standard Upside offering to pair with 3-leg base assembly.
- Verify any user provided worksurface accommodates 1"(25mm) pinch point clearance on all sides, meets at least a NFPA class C Flammability rating, and is compatible with all attached components.
- For a proper and safe work application, worksurfaces should be sized to prevent pinch points, collisions, and cable shearing.
- Base Only application (with user-provided worksurface) may require approval of local authority having jurisdiction (AHJ); ensure compliance before placing orders and installation.

To Order, Specify:

1) Product number, including:

1 Height Adjustment Range/ Paddle Options:

Standard Range (Single Stage):

- X Simple
- Y Programmable (add \$105.00 list)

Extended Range (Dual Stage):

- U Simple
- W Programmable (add \$105.00 list)

2) Base trim color.

Description/ Base Depth	Minimum Top Depth	Maximum Top Depth	Minimum Top Width	Maximum Top Width	Number 1	Trim A	B
3-leg Base for use with 90° and 120° tops:							
Single Stage (Standard Range)							
C-Leg/23"(584mm)	23"(584mm)	29"(737mm)	46"(1168mm)	82"(2083mm)	TJBA-3C	B-G	\$2060.00 \$ 2120.00
Dual Stage (Extended Range)							
C-Leg/23"(584mm)	23"(584mm)	29"(737mm)	46"(1168mm)	82"(2083mm)	TJBA-3C	B-G	\$2260.00 \$2320.00

Upside Worksurface for Table — Rectangular

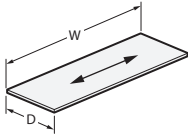

TRRA

Features

- Includes one 1.18”(30mm) thick high-pressure laminate (HPL) worksurface with pre-drilled for attachment to a separately specified C- or T-leg Upside table base.
- 3mm edgeband on user edgeband on user edge and 1mm on sides and back.
- Optional Belong Hatch cutout:
 - Available on worksurfaces 29”(737mm)D and widths 58”(1473mm) or greater
 - Requires separately specified Belong Hatch
 - Refer to Specification Guide for cutout details
- Depth and width shown in nominal dimensions.

Specification Tips

- See Specification Guide for worksurface weights.
- See Product Application pages for guidelines on pinch points when Height Adjustable Table is surrounded by walls, panels and/or other worksurfaces.
- Refer to Specification Guide/Product Application for guidelines to attach monitor arms, screens and other worktools.
- For an integrated power solution, separately specify Belong Hatch, Belong Power Suite, or Belong Wire Management Tray (see Accessories Price List for numbers).
- Not intended for use on other height adjustable product lines.
- Height adjustable table worksurfaces are designed to fit on the Upside C- or T-leg height adjustable table bases. Match desking worksurface depths to height adjustable table worksurfaces depths.
- Height adjustable table bases are width adjustable and may be used with all rectangular height adjustable worksurface widths. Maximum worksurface overhang allowed is 12”(305mm) on one or both sides of the frame.

To Order, Specify:

1) Product number, including:

1 Cutout:

- N None
- H Belong Hatch

2 Base Application:

- C C-leg
- T T-leg

2) Laminate surface color.

3) Edge trim color.

Depth	Width	Number 12	HPL		
			A	B	E
23”(584mm)	46”(1168mm)	TRRA-2346-LJSN <input type="checkbox"/> N	\$263.00	\$269.70	\$295.60
	52”(1321mm)	TRRA-2352-LJSN <input type="checkbox"/> N	297.80	308.52	349.96
	58”(1473mm)	TRRA-2358-LJSN <input type="checkbox"/> N	332.60	347.34	404.32
	64”(1626mm)	TRRA-2364-LJSN <input type="checkbox"/> N	367.40	386.16	458.68
	70”(1778mm)	TRRA-2370-LJSN <input type="checkbox"/> N	402.20	424.98	513.04
	76”(1930mm)	TRRA-2376-LJSN <input type="checkbox"/> N	437.00	463.80	567.40
	82”(2083mm)	TRRA-2382-LJSN <input type="checkbox"/> N	471.80	502.62	621.76
29”(737mm)	46”(1168mm)	TRRA-2946-LJSN <input type="checkbox"/> N	\$297.80	\$308.52	\$349.96
	52”(1321mm)	TRRA-2952-LJSN <input type="checkbox"/> N	332.60	347.34	404.32
	58”(1473mm)	TRRA-2958-LJS <input type="checkbox"/> <input type="checkbox"/> N	367.40	386.16	458.68
	64”(1626mm)	TRRA-2964-LJS <input type="checkbox"/> <input type="checkbox"/> N	402.20	424.98	513.04
	70”(1778mm)	TRRA-2970-LJS <input type="checkbox"/> <input type="checkbox"/> N	437.00	463.80	567.40
	76”(1930mm)	TRRA-2976-LJS <input type="checkbox"/> <input type="checkbox"/> N	471.80	502.62	621.76
	82”(2083mm)	TRRA-2982-LJS <input type="checkbox"/> <input type="checkbox"/> N	506.60	541.44	676.12

Upside Worksurface for Table — 90° Equal Corner - Wrap-Around

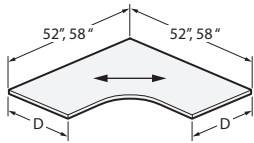

TRCR-5252

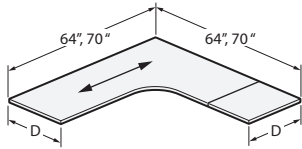

TRCR-7070

(Left-hand Orientation)

Upside Class US – GSA: Open Market
Upside- Class US

Features

- Includes 1.18" (30mm) thick high-pressure laminate (HPL) top with pre-drilled holes for attachment to Upside+ 3-leg base assembly (separately specified).
- High-Pressure Laminate (HPL) top with 3mm edgeband on user edge and 1mm on remaining edges.
- Worksurface will default to a 1-pc or 2-pc top based on size.
- Optional Belong Hatch cutout:
 - High-Pressure Laminate (HPL) tops only with one cutout.
 - Available on worksurfaces 29"(737mm)D and widths 64"(1626mm) and 70"(1778mm).
 - Hatch cutout can only be on the 29"(737mm) deep side.
 - Requires separately specified Belong Hatch.
 - Refer to Specification Guide for cutout details.
- Equal Corner worksurfaces 64"(1626mm) and greater will default to 2-pcs.
 - A 64"(1626mm) 2-piece top includes a 46"(1168mm) corner and 18"(457mm) rectangular extender.
 - A 70"(1778mm) includes a 52"(1321mm) corner and 18"(457mm) rectangular extender.
- Depth and width shown in nominal dimensions.

Specification Tips

- One-piece tops are non-handed; two-piece tops are handed.
- The seamless primary user side of the table (side without rectangular top) determines the handedness from a seated position.
- Size of the corner top is reflected in the catalog logic which allows for a 2"(51mm) pinch point in space planning; 58"(1473mm) corner may be space planned as a 60"(1524mm) corner for modular planning purposes.
- Separately specified screens must be smaller than the table width.
- Refer to Specification Guide/Product Application for guidelines to attach monitor arms, screens and other worktools.
- For an integrated power solution, separately specify Belong Hatch, Belong Power Suite, or Belong Wire Management Tray (see Accessories Price List for numbers).

To Order, Specify:

1) Product number, including:

1 **Cutout Option:**

- N** Without
- H** Belong Hatch

2 **Depth and Orientation:**

23" deep tops:

- E** LH (64" and 70" widths) two-piece top
- H** RH (64" and 70" widths) two-piece top

29" deep tops:

- F** LH (64" and 70" widths) two-piece top
- J** RH (64" and 70" widths) two-piece top

2) Laminate surface color.

3) Edge trim color.

Left/Right Depth	Width	No. of Pieces	Number	HPL	
				A	B
23"(584mm)/23"(584mm)	52"(1321mm)	1	TRCR-5252-LJSNCBN	\$ 748.50	\$ 825.30
	58"(1473mm)	1	TRCR-5858-LJSNCBN	803.00	887.60
	64"(1626mm)	2	TRCR-6464-LJSNC N	917.00	1009.40
	70"(1778mm)	2	TRCR-7070-LJSNC N	970.50	1070.70
29"(737mm)/29"(737mm)	52"(1321mm)	1	TRCR-5252-LJSNCCN	\$ 770.00	\$ 849.20
	58"(1473mm)	1	TRCR-5858-LJSNCCN	824.00	911.00
	64"(1626mm)	2	TRCR-6464-LJS C N	937.50	1032.30
	70"(1778mm)	2	TRCR-7070-LJS C N	991.50	1094.10

Upside Worksurface for Table — 90° Extended Corner – Wrap-Around

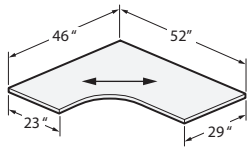

TRCE-4652
(Right-hand Orientation)

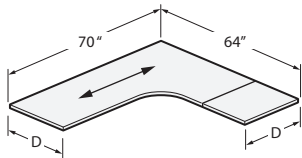

TRCE-6470
(Left-hand Orientation)
Upside Class US – GSA: Open Market
Upside- Class US

Features

- Includes 1.18" (30mm) thick high-pressure laminate (HPL) top with pre-drilled holes for attachment to Upside 3-leg base assembly (separately specified).
- High-Pressure Laminate (HPL) top with 3mm edgeband on user side and 1mm on remaining edges.
- Worksurface will default to a 1-pc or 2-pc top based on size (see chart below).
- Optional Belong Hatch cutout:
 - High-Pressure Laminate (HPL) tops only with one cutout.
 - Available on worksurfaces 29" (737mm)D and widths 46" (1168mm), 52" (1321mm), 58" (1473mm), 64" (1626mm), 70" (1778mm) and 76" (1930mm) with lengths 64" (1626mm), 70" (1778mm), 76" (1930mm) or 82" (2083mm).
 - Hatch cutout can only be on the 29" (737mm) deep side.
 - Requires separately specified Belong Hatch.
 - Refer to Specification Guide for cutout details.
- Depth and width shown in nominal dimensions.

Specification Tips

- Handedness determined by length side of table from seated position.
- Size of the corner top is reflected in the catalog logic which allows for a 2" (51mm) pinch point in space planning; 58" (1473mm) corner may be space planned as a 60" (1524mm) corner for modular planning purposes.
- Separately specified screens must be smaller than the table width.
- For application guidelines with attached worktools (monitor arms, screens, storage, wire management, etc.), see product application pages.
- For an integrated power solution, separately specify Belong Hatch, Belong Power Suite, or Belong Wire Management Tray (see Accessories Price List for numbers).

To Order, Specify:

1) Product number, including:

1 **Cutout Option:**

- N** Without
- H** Belong Hatch

2 **Depth and Orientation:**

23" deep tops:

- E** LH (64" and 82" widths) two-piece top
- H** RH (64" and 82" widths) two-piece top

29" deep tops:

- F** LH (64" and 82" widths) two-piece top
- J** RH (64" and 82" widths) two-piece top

2) Laminate surface color.

3) Edge trim color.

Two Piece Top	Corner	Rectangle
64" x 70" (1626mm x 1778mm)	46" x 70" (1168mm x 1778mm)	18" (457mm)
64" x 76" (1626mm x 1930mm)	46" x 76" (1168mm x 1930mm)	18" (457mm)
64" x 82" (1626mm x 2083mm)	46" x 82" (1168mm x 2083mm)	18" (457mm)
70" x 76" (1778mm x 1930mm)	52" x 76" (1321mm x 1930mm)	18" (457mm)
70" x 82" (1778mm x 2083mm)	52" x 82" (1321mm x 2083mm)	18" (457mm)
76" x 82" (1930mm x 2083mm)	58" x 82" (1473mm x 2083mm)	18" (457mm)

Upside Worksurface for Table — 90° Extended Corner - Wrap-Around

Left/Right Depth	Width	Length	No. of Pieces	Number	① ②	HPL			
						A	B		
23"(584mm)/23"(584mm)	46"(1168mm)	52"(1321mm)	1	TRCE-4652-LJSNC	N	\$ 621.50	\$ 694.40		
		58"(1473mm)	1	TRCE-4658-LJSNC	N	649.00	725.80		
		64"(1626mm)	1	TRCE-4664-LJSNC	N	675.50	756.20		
		70"(1778mm)	1	TRCE-4670-LJSNC	N	703.00	787.60		
		76"(1930mm)	1	TRCE-4676-LJSNC	N	730.00	818.50		
		82"(2083mm)	1	TRCE-4682-LJSNC	N	757.00	849.40		
	52"(1321mm)	58"(1473mm)	58"(1473mm)	1	TRCE-5258-LJSNC	N	\$ 775.50	\$ 856.20	
			64"(1626mm)	1	TRCE-5264-LJSNC	N	802.50	887.10	
			70"(1778mm)	1	TRCE-5270-LJSNC	N	830.00	918.50	
			76"(1930mm)	1	TRCE-5276-LJSNC	N	857.00	949.40	
			82"(2083mm)	1	TRCE-5282-LJSNC	N	883.50	979.80	
	58"(1473mm)	64"(1626mm)	64"(1626mm)	1	TRCE-5864-LJSNC	N	\$ 830.00	\$ 918.50	
			70"(1778mm)	1	TRCE-5870-LJSNC	N	857.00	949.40	
			76"(1930mm)	1	TRCE-5876-LJSNC	N	883.50	979.80	
			82"(2083mm)	1	TRCE-5882-LJSNC	N	910.50	1010.70	
	64"(1626mm)	70"(1778mm)	70"(1778mm)	2	TRCE-6470-LJSNC	N	\$ 943.50	\$1039.80	
76"(1930mm)			2	TRCE-6476-LJSNC	N	970.50	1070.70		
82"(2083mm)			2	TRCE-6482-LJSNC	N	998.00	1102.10		
70"(1778mm)		76"(1930mm)	76"(1930mm)	2	TRCE-7076-LJSNC	N	\$ 998.00	\$ 1102.10	
			82"(2083mm)	2	TRCE-7082-LJSNC	N	1025.00	1133.00	
			76"(1930mm)	2	TRCE-7682-LJSNC	N	\$1052.00	\$ 1163.90	
29"(737mm)/29"(737mm)	46"(1168mm)	52"(1321mm)	1	TRCE-4652-LJSNC	N	\$ 642.50	\$ 717.80		
		58"(1473mm)	1	TRCE-4658-LJSNC	N	670.00	749.20		
		64"(1626mm)	1	TRCE-4664-LJS	C N	696.50	779.60		
		70"(1778mm)	1	TRCE-4670-LJS	C N	724.00	811.00		
		76"(1930mm)	1	TRCE-4676-LJS	C N	750.50	841.40		
		82"(2083mm)	1	TRCE-4682-LJS	C N	778.00	872.80		
		52"(1321mm)	58"(1473mm)	58"(1473mm)	1	TRCE-5258-LJSNC	N	\$ 796.50	\$ 879.60
				64"(1626mm)	1	TRCE-5264-LJS	C N	823.50	910.50
				70"(1778mm)	1	TRCE-5270-LJS	C N	850.50	941.40
				76"(1930mm)	1	TRCE-5276-LJS	C N	877.50	972.30
				82"(2083mm)	1	TRCE-5282-LJS	C N	905.00	1003.70
		58"(1473mm)	64"(1626mm)	64"(1626mm)	1	TRCE-5864-LJS	C N	\$ 850.50	\$ 941.40
	70"(1778mm)			1	TRCE-5870-LJS	C N	877.50	972.30	
	76"(1930mm)			1	TRCE-5876-LJS	C N	905.00	1003.70	
	82"(2083mm)			1	TRCE-5882-LJS	C N	931.50	1034.10	
	64"(1626mm)	70"(1778mm)	70"(1778mm)	2	TRCE-6470-LJS	C N	\$ 965.00	\$1063.70	
			76"(1930mm)	2	TRCE-6476-LJS	C N	991.50	1094.10	
			82"(2083mm)	2	TRCE-6482-LJS	C N	1019.00	1125.50	
		70"(1778mm)	76"(1930mm)	76"(1930mm)	2	TRCE-7076-LJS	C N	\$ 1019.00	\$ 1125.50
				82"(2083mm)	2	TRCE-7082-LJS	C N	1045.50	1155.90
				76"(1930mm)	2	TRCE-7682-LJS	C N	\$1073.00	\$ 1187.30

Upside Worksurface for Table — 90° Transitional Extended Corner - Wrap-Around

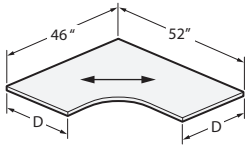

TRCE-4652
(Right-hand Orientation)

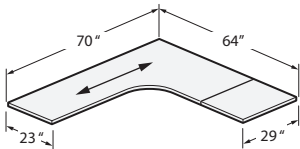

TRCE-4652
(Left-hand Orientation)
Upside Class US – GSA: Open Market
Upside- Class US

Features

- Includes 1.18" (30mm) thick high-pressure laminate (HPL) top with pre-drilled holes for attachment to Upside 3-leg base assembly (separately specified).
- High-Pressure Laminate (HPL) top with 3mm edgeband on user side and 1mm on remaining edges.
- Worksurface will default to a 1-pc or 2-pc top based on size (see chart below).
- Depth and width shown in nominal dimensions.

Specification Tips

- Depth orientation is listed from left to right (e.g. "R" = 23" depth on left side from seated position and 29" depth on right side from seated position).
- One-piece tops are non-handed; two-piece tops are handed.
- Handedness determined by length side of table from seated position.
- Size of the corner top is reflected in the catalog logic which allows for a 2" (51mm) pinch point in space planning; 58" (1473mm) corner may be space planned as a 60" (1524mm) corner for modular planning purposes.
- Separately specified screens must be smaller than the table width.
- Refer to Specification Guide/Product Application for guidelines to attach monitor arms, screens and other worktools.

To Order, Specify:

- 1) Product number, including:
 - 1** **Orientation (as seated):**
 - R** 23"(584mm)/29"(737mm) Right-Hand
 - K** 29"(737mm)/23"(584mm) Right-Hand
 - M** 23"(584mm)/29"(737mm) Left-Hand
 - A** 29"(737mm)/23"(584mm) Left-Hand
- 2) Laminate surface color.
- 3) Edge trim color.

Two Piece Top	Corner	Rectangle
64" x 70"(1626mm x 1778mm)	46" x 70"(1168mm x 1778mm)	18"(457mm)
64" x 76"(1626mm x 1930mm)	46" x 76"(1168mm x 1930mm)	18"(457mm)
64" x 82"(1626mm x 2083mm)	46" x 82"(1168mm x 2083mm)	18"(457mm)
70" x 76"(1778mm x 1930mm)	52" x 76"(1321mm x 1930mm)	18"(457mm)
70" x 82"(1778mm x 2083mm)	52" x 82"(1321mm x 2083mm)	18"(457mm)
76" x 82"(1930mm x 2083mm)	58" x 82"(1473mm x 2083mm)	18"(457mm)

Upside Worksurface for Table — 90° Transitional Extended Corner - Wrap-Around

Left/Right Depth	Width	Length	No. of Pieces	Number	①	HPL		
						A	B	
23"(584mm)/29"(737mm)	46"(1168mm)	52"(1321mm)	1	TRCE-4652-LJSNC	N	\$ 632.00	\$ 706.10	
		58"(1473mm)	1	TRCE-4658-LJSNC	N	659.50	737.50	
		64"(1626mm)	1	TRCE-4664-LJSNC	N	686.50	768.40	
		70"(1778mm)	1	TRCE-4670-LJSNC	N	713.50	799.30	
		76"(1930mm)	1	TRCE-4676-LJSNC	N	740.50	830.20	
		82"(2083mm)	1	TRCE-4682-LJSNC	N	767.00	860.60	
	52"(1321mm)	58"(1473mm)	1	TRCE-5258-LJSNC	N	\$ 786.50	\$ 868.40	
		64"(1626mm)	1	TRCE-5264-LJSNC	N	813.00	898.80	
		70"(1778mm)	1	TRCE-5270-LJSNC	N	840.50	930.20	
		76"(1930mm)	1	TRCE-5276-LJSNC	N	867.00	960.60	
		82"(2083mm)	1	TRCE-5282-LJSNC	N	894.50	992.00	
		58"(1473mm)	64"(1626mm)	1	TRCE-5864-LJSNC	N	\$ 840.50	\$ 930.20
	58"(1473mm)	70"(1778mm)	1	TRCE-5870-LJSNC	N	867.00	960.60	
		76"(1930mm)	1	TRCE-5876-LJSNC	N	894.50	992.00	
		82"(2083mm)	1	TRCE-5882-LJSNC	N	921.50	1022.90	
		64"(1626mm)	70"(1778mm)	2	TRCE-6470-LJSNC	N	\$ 954.00	\$ 1051.50
64"(1626mm)	76"(1930mm)	2	TRCE-6476-LJSNC	N	981.50	1082.90		
	82"(2083mm)	2	TRCE-6482-LJSNC	N	1008.50	1113.80		
	70"(1778mm)	76"(1930mm)	2	TRCE-7076-LJSNC	N	\$1008.50	\$ 1113.80	
	82"(2083mm)	2	TRCE-7082-LJSNC	N	1035.50	1144.70		
76"(1930mm)	82"(2083mm)	2	TRCE-7682-LJSNC	N	\$1062.00	\$ 1163.90		
	29"(737mm)/23"(584mm)	46"(1168mm)	52"(1321mm)	1	TRCE-4652-LJSNC	N	\$ 632.00	\$ 706.10
			58"(1473mm)	1	TRCE-4658-LJSNC	N	659.50	737.50
			64"(1626mm)	1	TRCE-4664-LJSNC	N	686.50	768.40
70"(1778mm)			1	TRCE-4670-LJSNC	N	713.50	799.30	
76"(1930mm)			1	TRCE-4676-LJSNC	N	740.50	830.20	
82"(2083mm)			1	TRCE-4682-LJSNC	N	767.00	860.60	
52"(1321mm)		58"(1473mm)	1	TRCE-5258-LJSNC	N	\$ 786.50	\$ 868.40	
		64"(1626mm)	1	TRCE-5264-LJSNC	N	813.00	898.80	
		70"(1778mm)	1	TRCE-5270-LJSNC	N	840.50	930.20	
		76"(1930mm)	1	TRCE-5276-LJSNC	N	867.00	960.60	
		82"(2083mm)	1	TRCE-5282-LJSNC	N	894.50	992.00	
		58"(1473mm)	64"(1626mm)	1	TRCE-5864-LJSNC	N	\$ 840.50	\$ 930.20
58"(1473mm)		70"(1778mm)	1	TRCE-5870-LJSNC	N	867.00	960.60	
		76"(1930mm)	1	TRCE-5876-LJSNC	N	894.50	992.00	
		82"(2083mm)	1	TRCE-5882-LJSNC	N	921.50	1022.90	
		64"(1626mm)	70"(1778mm)	2	TRCE-6470-LJSNC	N	\$ 954.00	\$ 1051.50
64"(1626mm)	76"(1930mm)	2	TRCE-6476-LJSNC	N	981.50	1082.90		
	82"(2083mm)	2	TRCE-6482-LJSNC	N	1008.50	1113.80		
	70"(1778mm)	76"(1930mm)	2	TRCE-7076-LJSNC	N	\$1008.50	\$ 1113.80	
	82"(2083mm)	2	TRCE-7082-LJSNC	N	1035.50	1144.70		
76"(1930mm)	82"(2083mm)	2	TRCE-7682-LJSNC	N	\$1062.00	\$ 1163.90		

Upside Worksurface for Table — 120° Corner – Wrap-Around

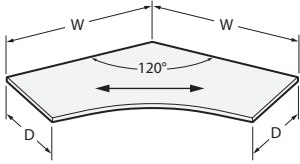

TRCZ-4646
Upside Class US – GSA: Open Market
Upside+ Class US

Features

- Includes 1.18" (30mm) thick high-pressure laminate (HPL) top with pre-drilled holes for attachment to Upside 3-leg base assembly (separately specified).
- High-Pressure Laminate (HPL) top with 3mm edgeband on user side and 1mm on remaining edges.
- Depth and width shown in nominal dimensions.

Specification Tips

- Size of the corner top is reflected in the catalog logic which allows for a 2" (51mm) pinch point in space planning; 58" (1473mm) corner may be space planned as a 60" (1524mm) corner for modular planning purposes.
- Separately specified screens must be smaller than the table width.
- Refer to Specification Guide/Product Application for guidelines to attach monitor arms, screens and other worktools.

To Order, Specify:

- 1) Product number.
- 2) Laminate surface color.
- 3) Edge trim color.

Left/Right Depth	Width	Length	No. of Pieces	Number	HPL	
					A	B
23"(584mm)/23"(584mm)	46"(1168mm)	46"(1168mm)	1	TRCZ-4646-LJSNCBN	\$ 866.00	\$ 971.34
	52"(1321mm)	52"(1321mm)	1	TRCZ-5252-LJSNCBN	950.00	1067.10
	58"(1473mm)	58"(1473mm)	1	TRCZ-5858-LJSNCBN	1034.00	1162.86
29"(737mm)/29"(737mm)	46"(1168mm)	46"(1168mm)	1	TRCZ-4646-LJSNCCN	\$ 890.00	\$ 999.30
	52"(1321mm)	52"(1321mm)	1	TRCZ-5252-LJSNCCN	974.00	1095.06
	58"(1473mm)	58"(1473mm)	1	TRCZ-5858-LJSNCCN	1058.00	1190.82

Planes Benching

Catalog Logic

TA RA - 30 58 - L J S N H R

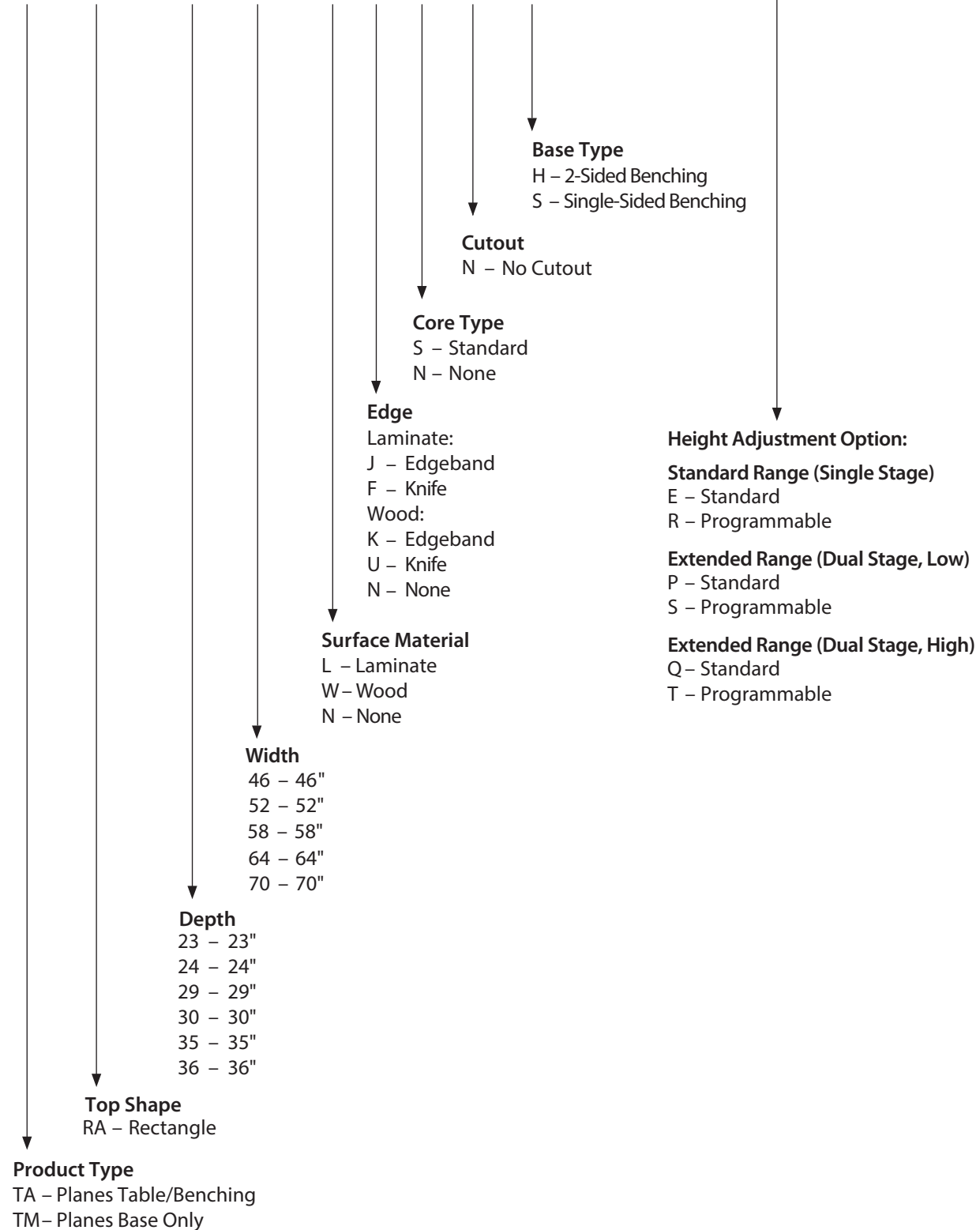

Planes Two-Sided Benching — Rectangular

Electric Adjustment

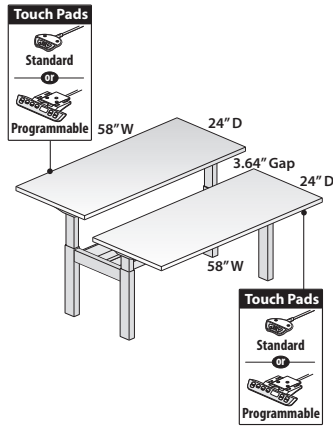

TARA-2458-NH
Class TA

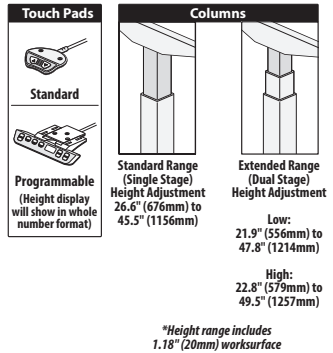

Features

- Includes:
 - Two 1.18"(30mm) thick rectangle worksurfaces
 - Two telescoping base assemblies with fixed J-Rail frame system
 - Two crossbeams for back-to-back base connection
 - Power and data channel with troughs
 - Two Standard or programmable touch pad switches
 - Wire management clips
 - Two 9'(2743mm) long black power cord with NEMA 5-15P plug
 - Adjustable glides and hardware standard in black with 1"(25mm) of adjustment
 - Electric Height Adjustment:
 - Speed: 1.4"(36mm) per second
 - Standard Range (Single Stage) telescoping columns feature 18.9"(480mm) of continuous adjustment.
 - Extended Range (Dual Stage) telescoping columns feature a range of 25.9"(658mm) - 26.7"(678mm) of continuous adjustment.
 - Worksurface:
 - High-Pressure Laminate (HPL) or Veneer with knife edge or 3mm edgeband option
 - 3mm Edgeband on user edge and 1mm on remaining edges
 - Base Assembly:
 - Telescoping inner columns default to matching or coordinating paint colors. See Finish pages for details.
 - Ships unassembled.
 - Depth and width shown in nominal dimension
- ### Specification Tips
- Not designed for use with casters.
 - See Specification Guide Product Applications for instructions on how to specify a powered benching run.
 - Select a worksurface that accommodates 1"(25mm) of pinch point clearance on all sides and meets at least a NFPA class C flammability rating; refer to Specification Guide for application guidelines
 - 3- or 4-Circuit power In, Thru, and Out distribution options available. See **Electrical Components and Covers**.
 - Total lifting capacity of each table is 250 lbs. including surface; applied weight should be evenly distributed.
 - See Product Application guidelines for use with attached worktools.
 - Monitor Arms
 - Screens
 - Suspended Storage
 - Horizontal and Vertical Wire management
 - Application may require approval of local authority having jurisdiction (AHJ); ensure compliance before placing orders and installation.

To Order, Specify:

1) Product number, including:

1 Surface Options:

- L** Laminate
- W** Wood

2 Edge Options:

- Laminate:
- J** Edgeband
 - F** Knife

- Wood:
- K** Edgeband
 - U** Knife

3 Height Adjustment Options:

- Standard Range (Single Stage):
- E** Standard
 - R** Programmable (add **\$404.31** list)

- Extended Range (Dual Stage, Low):
- P** Standard
 - S** Programmable (add **\$404.31** list)

- (Dual Stage, High):
- Q** Standard
 - T** Programmable (add **\$404.31** list)

- 2) Laminate surface color or wood finish color.
- 3) Edge trim color (laminite only).
- 4) Base trim color.

Note: \$126.99 upcharge list for Grade B trim colors.

Planes Two-Sided Benching — Rectangular

Electric Adjustment

Depth	Width	Number ①②	③	HPL A		HPL B		HPL E		Wood A		Wood B	
				J	F	J	F	J	F	K	U	K	U
Standard Range (Single Stage)													
23"(584mm)	46"(1168mm)	TARA-2346-	SNH	\$ 8596.70	\$ 9133.39	\$ 8643.84	\$ 9180.53	\$ 8935.63	\$ 9472.32	\$ 9599.96	\$ 10201.51	\$ 9635.20	\$ 10236.75
	52"(1321mm)	TARA-2352-	SNH	8788.66	9366.75	8841.95	9420.04	9171.79	9749.88	9879.16	10527.75	9919.00	10567.59
	58"(1473mm)	TARA-2358-	SNH	8980.63	9600.12	9040.07	9659.56	9407.97	10027.46	10158.37	10854.00	10202.81	10898.44
	64"(1626mm)	TARA-2364-	SNH	9172.59	9833.48	9238.18	9899.07	9644.14	10305.03	10437.57	11180.24	10486.61	11229.28
	70"(1778mm)	TARA-2370-	SNH	9364.56	10066.85	9436.29	10138.58	9880.32	10582.61	10716.78	11506.49	10770.41	11560.12
24"(610mm)	46"(1168mm)	TARA-2446-	SNH	\$ 8623.50	\$ 9167.09	\$ 8672.68	\$ 9216.27	\$ 8977.16	\$ 9520.75	\$ 9641.30	\$ 10250.69	\$ 9678.07	\$ 10287.46
	52"(1321mm)	TARA-2452-	SNH	8818.80	9403.79	8874.41	9459.40	9218.59	9803.58	9923.84	10580.27	9965.42	10621.85
	58"(1473mm)	TARA-2458-	SNH	9014.12	9640.51	9076.14	9702.53	9460.04	10086.43	10206.40	10909.87	10252.77	10956.24
	64"(1626mm)	TARA-2464-	SNH	9209.43	9877.22	9277.86	9945.65	9701.48	10369.27	10488.95	11239.46	10540.11	11290.62
	70"(1778mm)	TARA-2470-	SNH	9404.75	10113.94	9479.60	10188.79	9942.93	10652.12	10771.51	11569.06	10827.47	11625.02
29"(737mm)	46"(1168mm)	TARA-2946-	SNH	\$ 8811.56	\$ 9389.65	\$ 8871.00	\$ 9449.09	\$ 9238.90	\$ 9816.99	\$ 9902.06	\$ 10550.65	\$ 9946.50	\$ 10595.09
	52"(1321mm)	TARA-2952-	SNH	9023.60	9643.09	9090.79	9710.28	9506.68	10126.17	10201.34	10896.97	10251.57	10947.20
	58"(1473mm)	TARA-2958-	SNH	9235.65	9896.54	9310.59	9971.48	9774.47	10435.36	10500.63	11243.30	10556.66	11299.33
	64"(1626mm)	TARA-2964-	SNH	9447.69	10149.98	9530.38	10232.67	10042.25	10744.54	10799.91	11589.62	10861.74	11651.45
	70"(1778mm)	TARA-2970-	SNH	9659.74	10403.43	9750.19	10493.88	10310.04	11053.73	11099.20	11935.95	11166.82	12003.57
30"(762mm)	46"(1168mm)	TARA-3046-	SNH	\$ 8838.36	\$ 9423.35	\$ 8899.84	\$ 9484.83	\$ 9280.43	\$ 9865.42	\$ 9943.40	\$ 10599.83	\$ 9989.37	\$ 10645.80
	52"(1321mm)	TARA-3052-	SNH	9053.74	9680.13	9123.25	9749.64	9553.48	10179.87	10246.02	10949.49	10297.99	11001.46
	58"(1473mm)	TARA-3058-	SNH	9269.14	9936.93	9346.67	10014.46	9826.54	10494.33	10548.66	11299.17	10606.62	11357.13
	64"(1626mm)	TARA-3064-	SNH	9484.53	10193.72	9570.07	10279.26	10099.59	10808.78	10851.29	11648.84	10915.25	11712.80
	70"(1778mm)	TARA-3070-	SNH	9699.92	10450.51	9793.49	10544.08	10372.65	11123.24	11153.92	11998.51	11223.88	12068.47
35"(889mm)	46"(1168mm)	TARA-3546-	SNH	\$ 9026.41	\$ 9645.90	\$ 9098.14	\$ 9717.63	\$ 9542.17	\$ 10161.66	\$ 10204.15	\$ 10899.78	\$ 10257.78	\$ 10953.41
	52"(1321mm)	TARA-3552-	SNH	9258.54	9919.43	9339.63	10000.52	9841.57	10502.46	10523.52	11266.19	10584.15	11326.82
	58"(1473mm)	TARA-3558-	SNH	9490.66	10192.95	9581.11	10283.40	10140.96	10843.25	10842.88	11632.59	10910.50	11700.21
	64"(1626mm)	TARA-3564-	SNH	9722.79	10466.48	9822.59	10566.28	10440.36	11184.05	11162.25	11999.00	11236.87	12073.62
	70"(1778mm)	TARA-3570-	SNH	9954.91	10740.00	10064.07	10849.16	10739.76	11524.85	11481.61	12365.40	11563.22	11563.22
36"(914mm)	46"(1168mm)	TARA-3646-	SNH	\$ 9053.21	\$ 9679.60	\$ 9126.99	\$ 9753.38	\$ 9583.70	\$ 10210.09	\$ 10245.49	\$ 10948.96	\$ 10300.65	\$ 11004.12
	52"(1321mm)	TARA-3652-	SNH	9288.69	9956.48	9372.09	10039.88	9888.37	10556.16	10568.21	11318.72	10630.56	11381.07
	58"(1473mm)	TARA-3658-	SNH	9524.15	10233.34	9617.18	10326.37	10193.03	10902.22	10890.91	11688.46	10960.47	11758.02
	64"(1626mm)	TARA-3664-	SNH	9759.63	10510.22	9862.28	10612.87	10497.70	11248.29	11213.63	12058.22	11290.38	12134.97
	70"(1778mm)	TARA-3670-	SNH	9995.09	10787.08	10107.37	10899.36	10802.36	11594.35	11536.33	12427.96	11620.28	12511.91

Note:

- Screens:
 - Specify 24"(610mm), 30"(762mm), and 36"(914mm) depth benches with Center Mounted Screens.
 - Specify 23"(584mm), 29"(737mm), and 35"(889mm) depth benches with Worksurface Mounted Screens.

Planes Two-Sided Benching — Rectangular

Electric Adjustment

Depth	Width	Number ①②	③	HPL A		HPL B		HPL E		Wood A		Wood B	
				J	F	J	F	J	F	K	U	K	U
Extended Range (Dual Stage)													
23"(584mm)	46"(1168mm)	TARA-2346-	SNH	\$10800.23	\$11336.92	\$10847.37	\$11384.06	\$1139.16	\$11675.85	\$11803.49	\$12405.04	\$11838.73	\$12440.28
	52"(1321mm)	TARA-2352-	SNH	11034.57	11612.66	11087.86	11665.95	11417.70	11995.79	12125.07	12773.66	12164.91	12813.50
	58"(1473mm)	TARA-2358-	SNH	11268.91	11888.40	11328.35	11947.84	11696.25	12315.74	12446.65	13142.28	12491.09	13186.72
	64"(1626mm)	TARA-2364-	SNH	11503.25	12164.14	11568.84	12229.73	11974.80	12635.69	12768.23	13510.90	12817.27	13559.94
	70"(1778mm)	TARA-2370-	SNH	11737.59	12439.88	11809.32	12511.61	12253.35	12955.64	13089.81	13879.52	13143.44	13933.15
24"(610mm)	46"(1168mm)	TARA-2446-	SNH	\$10827.03	\$11370.62	\$10876.21	\$11419.80	\$1180.69	\$11724.28	\$11844.83	\$12454.22	\$11881.60	\$12490.99
	52"(1321mm)	TARA-2452-	SNH	11064.71	11649.70	11120.32	11705.31	11464.50	12049.49	12169.75	12826.18	12211.33	12867.76
	58"(1473mm)	TARA-2458-	SNH	11302.40	11928.79	11364.42	11990.81	11748.32	12374.71	12494.68	13198.15	12541.05	13244.52
	64"(1626mm)	TARA-2464-	SNH	11540.09	12207.88	11608.52	12276.31	12032.14	12699.93	12819.61	13570.12	12870.77	13621.28
	70"(1778mm)	TARA-2470-	SNH	11777.78	12486.97	11852.63	12561.82	12315.96	13025.15	13144.54	13942.09	13200.50	13998.05
29"(737mm)	46"(1168mm)	TARA-2946-	SNH	\$11036.28	\$11614.37	\$11095.72	\$11673.81	\$11463.62	\$12041.71	\$12126.78	\$12775.37	\$12171.22	\$12819.81
	52"(1321mm)	TARA-2952-	SNH	11290.70	11910.19	11357.89	11977.38	11773.78	12393.27	12468.44	13164.07	12518.67	13214.30
	58"(1473mm)	TARA-2958-	SNH	11545.12	12206.01	11620.06	12280.95	12083.94	12744.83	12810.10	13552.77	12866.13	13608.80
	64"(1626mm)	TARA-2964-	SNH	11799.54	12501.83	11882.23	12584.52	12394.10	13096.39	13151.76	13941.47	13213.59	14003.30
	70"(1778mm)	TARA-2970-	SNH	12053.96	12797.65	12144.41	12888.10	12704.26	13447.95	13493.42	14330.17	13561.04	14397.79
30"(762mm)	46"(1168mm)	TARA-3046-	SNH	\$11063.08	\$11648.07	\$1124.56	\$11709.55	\$11505.15	\$12090.14	\$12168.12	\$12824.55	\$12214.09	\$12870.52
	52"(1321mm)	TARA-3052-	SNH	11320.84	11947.23	11390.35	12016.74	11820.58	12446.97	12513.12	13216.59	12565.09	13268.56
	58"(1473mm)	TARA-3058-	SNH	11578.61	12246.40	11656.14	12323.93	12136.01	12803.80	12858.13	13608.64	12916.09	13666.60
	64"(1626mm)	TARA-3064-	SNH	11836.38	12545.57	11921.92	12631.11	12451.44	13160.63	13203.14	14000.69	13267.10	14064.65
	70"(1778mm)	TARA-3070-	SNH	12094.14	12844.73	12187.71	12938.30	12766.87	13517.46	13548.14	14392.73	13618.10	14462.69
35"(889mm)	46"(1168mm)	TARA-3546-	SNH	\$11272.32	\$11891.81	\$11344.05	\$11963.54	\$11788.08	\$12407.57	\$12450.06	\$13145.69	\$12503.69	\$13199.32
	52"(1321mm)	TARA-3552-	SNH	11546.82	12207.71	11627.91	12288.80	12129.85	12790.74	12811.80	13554.47	12872.43	13615.10
	58"(1473mm)	TARA-3558-	SNH	11821.32	12523.61	11911.77	12614.06	12471.62	13173.91	13173.54	13963.25	13241.16	14030.87
	64"(1626mm)	TARA-3564-	SNH	12095.82	12839.51	12195.62	12939.31	12813.39	13557.08	13535.28	14372.03	13609.90	14446.65
	70"(1778mm)	TARA-3570-	SNH	12370.32	13155.41	12479.48	13264.57	13155.17	13940.26	13897.02	14780.81	13978.63	14862.42
36"(914mm)	46"(1168mm)	TARA-3646-	SNH	\$11299.12	\$11925.51	\$11372.90	\$11999.29	\$11829.61	\$12456.00	\$12491.40	\$13194.87	\$12546.56	\$13250.03
	52"(1321mm)	TARA-3652-	SNH	11576.97	12244.76	11660.37	12328.16	12176.65	12844.44	12856.49	13607.00	12918.84	13669.35
	58"(1473mm)	TARA-3658-	SNH	11854.81	12564.00	11947.84	12657.03	12523.69	13232.88	13221.57	14019.12	13291.13	14088.68
	64"(1626mm)	TARA-3664-	SNH	12132.66	12883.25	12235.31	12985.90	12870.73	13621.32	13586.66	14431.25	13663.41	14508.00
	70"(1778mm)	TARA-3670-	SNH	12410.50	13202.49	12522.78	13314.77	13217.77	14009.76	13951.74	14843.37	14035.69	14927.32

Planes Single-Sided Benching — Rectangular

Electric Adjustment

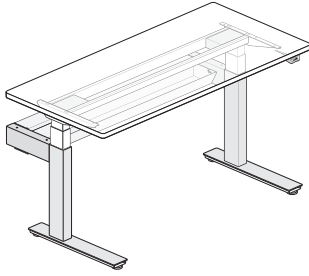

TARA-2468-NH
Class TA

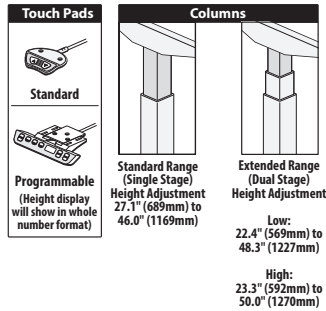

*Height range includes
1.18" (20mm) worksurface



Features

- Includes:
 - 1.18"(30mm) thick rectangle worksurface
 - Telescoping base assembly with crossbeams
 - Fixed J-Rail frame system
 - Power and data channel with trough
 - Standard or programmable touch pad switch
 - Wire management clips
 - 9'(2743mm) long black power cord with NEMA 5-15P plug
 - Adjustable glides and hardware standard in black with 1"(25mm) of adjustment
- Electric Height Adjustment:
 - Speed: 1.4"(36mm) per second
 - Standard Range (Single Stage) telescoping columns feature 18.9"(480mm) of continuous adjustment.
 - Extended Range (Dual Stage) telescoping columns feature a range of 25.9"(658mm) - 26.7"(678mm) of continuous adjustment.
- Worksurface:
 - High-Pressure Laminate (HPL) or Veneer with knife edge or 3mm edgeband option
 - 3mm Edgeband on user edge and 1mm on remaining edges
- Base Assembly:
 - Telescoping inner columns default to matching or coordinating paint colors. See Finish pages for details.
 - Ships unassembled.
- Depth and width shown in nominal dimension.

Specification Tips

- Not designed for use with casters.
- See Spec Guide Product Applications for instructions on how to specify a powered run of benching.
- Single-sided bench unit cannot be used as a freestanding table. It MUST be attached to another bench of equal or greater size.
- Select a worksurface that accommodates 1"(25mm) of pinch point clearance on all sides and meets at least a NFPA class C flammability rating; refer to Specification Guide for application guidelines.
- 3- or 4-Circuit power In, Thru, and Out distribution options available. See **Electrical Components and Covers**.
- Total lifting capacity of each table is 250 lbs. including surface; applied weight should be evenly distributed.
- See Product Application guidelines for use with attached worktools.
 - Monitor Arms
 - Screens
 - Suspended Storage
 - Horizontal and Vertical Wire management.
- Application may require approval of local authority having jurisdiction (AHJ); ensure compliance before placing orders and installation.

To Order, Specify:

1) Product number, including:

1 Surface Options:

- L** Laminate
- W** Wood

2 Edge Options:

- Laminate:
- J** Edgeband
 - F** Knife

- Wood:
- K** Edgeband
 - U** Knife

3 Height Adjustment Options:

- Standard Range (Single Stage):
- E** Standard
 - R** Programmable (add **\$202.15** list)

- Extended Range (Dual Stage, Low):
- P** Standard
 - S** Programmable (add **\$202.15** list)

- (Dual Stage, High):
- Q** Standard
 - T** Programmable (add **\$202.15** list)

- 2) Laminate surface color or wood finish color.
- 3) Edge trim color (laminite only).
- 4) Base trim color.

Note: \$63.50 upcharge list for Grade B trim colors.

Planes Single-Sided Benching — Rectangular

Electric Adjustment

Depth	Width	Number ①②	③	HPL A		HPL B		HPL E		Wood A		Wood B	
				J	F	J	F	J	F	K	U	K	U
Standard Range (Single Stage)													
23"(584mm)	46"(1168mm)	TARA-2346-	SNS	\$ 4330.13	\$ 4806.23	\$ 4377.30	\$ 4853.40	\$ 4669.28	\$ 5145.38	\$ 5333.39	\$ 5874.35	\$ 5368.65	\$ 5909.61
	52"(1321mm)	TARA-2352-	SNS	4474.43	4991.93	4527.75	5045.25	4857.81	5375.31	5564.93	6152.93	5604.79	6192.79
	58"(1473mm)	TARA-2358-	SNS	4618.73	5177.63	4678.20	5237.10	5046.35	5605.25	5796.47	6431.51	5840.94	6475.98
	64"(1626mm)	TARA-2364-	SNS	4763.03	5363.33	4828.66	5428.96	5234.89	5835.19	6028.01	6710.09	6077.08	6759.16
	70"(1778mm)	TARA-2370-	SNS	4907.33	5549.03	4979.11	5620.81	5423.43	6065.13	6259.55	6988.67	6313.22	7042.34
24"(610mm)	46"(1168mm)	TARA-2446-	SNS	\$ 4356.94	\$ 4839.94	\$ 4406.16	\$ 4889.16	\$ 4710.83	\$ 5193.83	\$ 5374.74	\$ 5923.54	\$ 5411.54	\$ 5960.34
	52"(1321mm)	TARA-2452-	SNS	4504.59	5028.99	4560.23	5084.63	4904.64	5429.04	5609.63	6205.47	5651.23	6247.07
	58"(1473mm)	TARA-2458-	SNS	4652.24	5218.04	4714.30	5280.10	5098.45	5664.25	5844.52	6487.40	5890.92	6533.80
	64"(1626mm)	TARA-2464-	SNS	4799.89	5407.09	4868.37	5475.57	5292.26	5899.46	6079.41	6769.33	6130.61	6820.53
	70"(1778mm)	TARA-2470-	SNS	4947.54	5596.14	5022.44	5671.04	5486.07	6134.67	6314.30	7051.26	6370.30	7107.26
29"(737mm)	46"(1168mm)	TARA-2946-	SNS	\$ 4521.23	\$ 5038.73	\$ 4580.70	\$ 5098.20	\$ 4948.85	\$ 5466.35	\$ 5611.73	\$ 6199.73	\$ 5656.20	\$ 6244.20
	52"(1321mm)	TARA-2952-	SNS	4685.62	5244.52	4752.85	5311.75	5169.02	5727.92	5863.36	6498.40	5913.63	6548.67
	58"(1473mm)	TARA-2958-	SNS	4850.02	5450.32	4925.01	5525.31	5389.19	5989.49	6115.00	6797.08	6171.06	6853.14
	64"(1626mm)	TARA-2964-	SNS	5014.41	5656.11	5097.16	5738.86	5609.36	6251.06	6366.63	7095.75	6428.50	7157.62
	70"(1778mm)	TARA-2970-	SNS	5178.80	5861.90	5269.31	5952.41	5829.53	6512.63	6618.26	7394.42	6685.93	7462.09
30"(762mm)	46"(1168mm)	TARA-3046-	SNS	\$ 4548.04	\$ 5072.44	\$ 4609.57	\$ 5133.97	\$ 4990.41	\$ 5514.81	\$ 5653.08	\$ 6248.92	\$ 5699.08	\$ 6294.92
	52"(1321mm)	TARA-3052-	SNS	4715.79	5281.59	4785.34	5351.14	5215.85	5781.65	5908.07	6550.95	5960.07	6602.95
	58"(1473mm)	TARA-3058-	SNS	4883.53	5490.73	4961.10	5568.30	5441.29	6048.49	6163.05	6852.97	6221.05	6910.97
	64"(1626mm)	TARA-3064-	SNS	5051.27	5699.87	5136.87	5785.47	5666.74	6315.34	6418.03	7154.99	6482.03	7218.99
	70"(1778mm)	TARA-3070-	SNS	5219.01	5909.01	5312.64	6002.64	5892.18	6582.18	6673.01	7457.01	6743.01	7527.01
Extended Range (Dual Stage)													
23"(584mm)	46"(1168mm)	TARA-2346-	SNS	\$ 5248.13	\$ 5724.23	\$ 5295.30	\$ 5771.40	\$ 5587.28	\$ 6063.38	\$ 6251.39	\$ 6792.35	\$ 6286.65	\$ 6827.61
	52"(1321mm)	TARA-2352-	SNS	5410.08	5927.58	5463.40	5980.90	5793.46	6310.96	6500.58	7088.58	6540.44	7128.44
	58"(1473mm)	TARA-2358-	SNS	5572.04	6130.94	5631.51	6190.41	5999.66	6558.56	6749.78	7384.82	6794.25	7429.29
	64"(1626mm)	TARA-2364-	SNS	5733.99	6334.29	5799.62	6399.92	6205.85	6806.15	6998.97	7681.05	7048.04	7730.12
	70"(1778mm)	TARA-2370-	SNS	5895.95	6537.65	5967.73	6609.43	6412.05	7053.75	7248.17	7977.29	7301.84	8030.96
24"(610mm)	46"(1168mm)	TARA-2446-	SNS	\$ 5274.94	\$ 5757.94	\$ 5324.16	\$ 5807.16	\$ 5628.83	\$ 6111.83	\$ 6292.74	\$ 6841.54	\$ 6329.54	\$ 6878.34
	52"(1321mm)	TARA-2452-	SNS	5440.24	5964.64	5495.88	6020.28	5840.29	6364.69	6545.28	7141.12	6586.88	7182.72
	58"(1473mm)	TARA-2458-	SNS	5605.55	6171.35	5667.61	6233.41	6051.76	6617.56	6797.83	7440.71	6844.23	7487.11
	64"(1626mm)	TARA-2464-	SNS	5770.85	6378.05	5839.33	6446.53	6263.22	6870.42	7050.37	7740.29	7101.57	7791.49
	70"(1778mm)	TARA-2470-	SNS	5936.16	6584.76	6011.06	6659.66	6474.69	7123.29	7302.92	8039.88	7358.92	8095.88
29"(737mm)	46"(1168mm)	TARA-2946-	SNS	\$ 5448.06	\$ 5965.56	\$ 5507.53	\$ 6025.03	\$ 5875.68	\$ 6393.18	\$ 6538.56	\$ 7126.56	\$ 6583.03	\$ 7171.03
	52"(1321mm)	TARA-2952-	SNS	5630.10	6189.00	5697.33	6256.23	6113.50	6672.40	6807.84	7442.88	6858.11	7493.15
	58"(1473mm)	TARA-2958-	SNS	5812.15	6412.45	5887.14	6487.44	6351.32	6951.62	7077.13	7759.21	7133.19	7815.27
	64"(1626mm)	TARA-2964-	SNS	5994.20	6635.90	6076.95	6718.65	6589.15	7230.85	7346.42	8075.54	7408.29	8137.41
	70"(1778mm)	TARA-2970-	SNS	6176.24	6859.34	6266.75	6949.85	6826.97	7510.07	7615.70	8391.86	7683.37	8459.53
30"(762mm)	46"(1168mm)	TARA-3046-	SNS	\$ 5474.87	\$ 5999.27	\$ 5536.40	\$ 6060.80	\$ 5917.24	\$ 6441.64	\$ 6579.91	\$ 7175.75	\$ 6625.91	\$ 7221.75
	52"(1321mm)	TARA-3052-	SNS	5660.27	6226.07	5729.82	6295.62	6160.33	6726.13	6852.55	7495.43	6904.55	7547.43
	58"(1473mm)	TARA-3058-	SNS	5845.66	6452.86	5923.23	6530.43	6403.42	7010.62	7125.18	7815.10	7183.18	7873.10
	64"(1626mm)	TARA-3064-	SNS	6031.06	6679.66	6116.66	6765.26	6646.53	7295.13	7397.82	8134.78	7461.82	8198.78
	70"(1778mm)	TARA-3070-	SNS	6216.45	6906.45	6310.08	7000.08	6889.62	7579.62	7670.45	8454.45	7740.45	8524.45

Planes 120° Benching

Catalog Logic

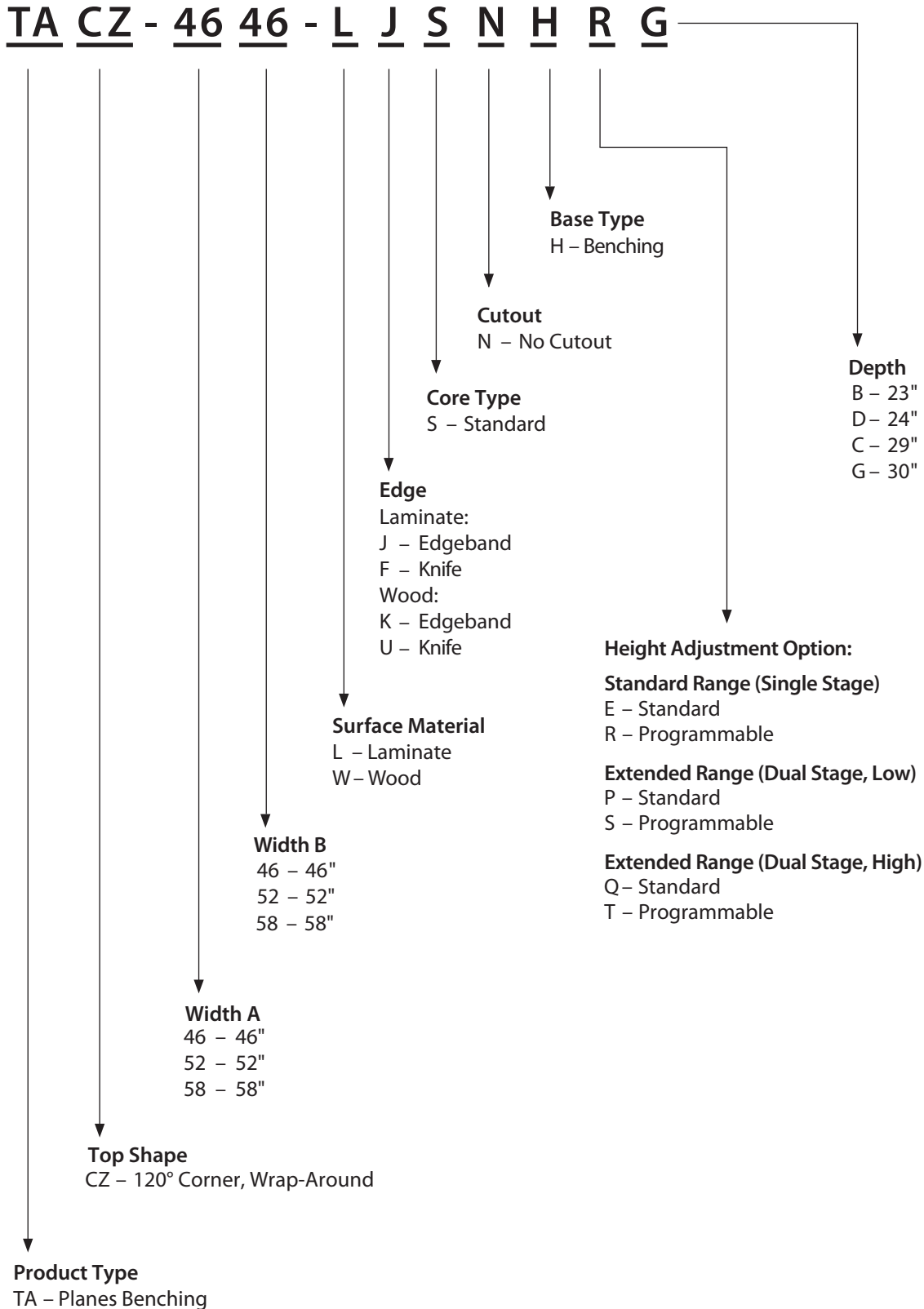

Planes Three-Sided Benching — 120°

Electric Adjustment

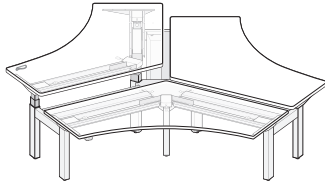

TACZ
Class TA

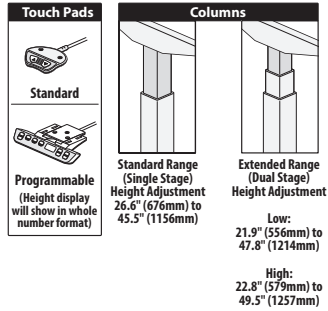

*Height range includes
1.18" (20mm) worksurface



Features

- Includes:
 - Three 1.18" (30mm) thick 120 degree worksurfaces
 - 3 sets of Telescoping base assemblies with crossbeams
 - Fixed J-Rail frame system
 - Three Power and data channels with troughs
 - Center connection tray and triangle cover
 - Three Standard or programmable touch pad switches
 - Wire management clips
 - Three 9'(2743mm) long black power cords with NEMA 5-15P plugs
 - Three cable extensions (for top width 52"(1321mm) or greater)
 - Adjustable glides and hardware standard in black with 1"(25mm) of adjustment
- Electric Height Adjustment:
 - Speed: 1.4"(36mm) per second
 - Standard Range (Single Stage) telescoping columns feature 18.9"(480mm) of continuous adjustment.
 - Extended Range (Dual Stage) telescoping columns feature a range of 25.9"(658mm) - 26.7"(678mm) of continuous adjustment.
- Worksurface:
 - High-Pressure Laminate (HPL) or Veneer with knife edge or 3mm edgeband option
 - 3mm Edgeband on user edge and 1mm on remaining edges
- Base Assembly:
 - Telescoping inner columns default to matching or coordinating paint colors. See Finish pages for details.
 - Ships unassembled.
- Depth and width shown in nominal dimension.

Specification Tips

- Not designed for use with casters.
- See Specification Guide Product Applications for instructions on how to specify a powered run of benching.
- Select a worksurface that accommodates 1"(25mm) of pinch point clearance on all sides and meets at least a NFPA class C flammability rating; refer to Specification Guide for application guidelines.
- 3- or 4-Circuit power In, Thru, and Out distribution options available. See **Electrical Components and Covers**.
- Total lifting capacity of each table is 300 lbs. including surface; applied weight should be evenly distributed.
- See Product Application guidelines for use with attached worktools.
 - Monitor Arms
 - Screens
 - Suspended Storage
 - Horizontal and Vertical Wire management
- Application may require approval of local authority having jurisdiction (AHJ); ensure compliance before placing orders and installation.

To Order, Specify:

1) Product number, including:

1 Surface Options:

- L** Laminate
- W** Wood

2 Edge Options:

- Laminate:
- J** Edgeband
 - F** Knife
- Wood:
- K** Edgeband
 - U** Knife

3 Height Adjustment Options:

- Standard Range (Single Stage):
- E** Standard
 - R** Programmable (add **\$606.44** list)

- Extended Range (Dual Stage, Low):
- P** Standard
 - S** Programmable (add **\$606.44** list)

- (Dual Stage, High):
- Q** Standard
 - T** Programmable (add **\$606.44** list)

- 2) Laminate surface color or wood finish color.
- 3) Edge trim color (laminite only).
- 4) Base trim color.

Note: \$126.99 upcharge list for Grade B trim colors.

Planes Three-Sided Benching — 120°

Electric Adjustment

Depth	Width	Top Weights (lbs.)	Number ①②	③	HPL A		HPL B		Wood A		Wood B		
					F	J	F	J	K	U	K	U	
Standard Range (Single Stage)													
23"(584mm)	46"(1168mm)	68	TACZ-4646-	SNH	B	\$ 25207.72	\$ 25828.90	\$ 25916.51	\$ 26537.69	\$ 30120.15	\$ 32166.39	\$30293.30	\$ 32339.54
	52"(1321mm)	79	TACZ-5252-	SNH	B	25475.70	26175.42	26202.97	26902.69	30868.39	33173.35	31055.34	33360.30
	58"(1473mm)	91	TACZ-5858-	SNH	B	25741.99	26516.68	26487.76	27262.45	31593.11	34145.03	31793.88	34345.80
24"(610mm)	46"(1168mm)	72	TACZ-4646-	SNH	D	\$ 25286.41	\$ 25911.16	\$ 26001.36	\$ 26626.11	\$30220.67	\$ 32278.67	\$ 30398.41	\$ 32456.41
	52"(1321mm)	83	TACZ-5252-	SNH	D	25562.75	26262.47	26296.99	26996.71	30955.44	33260.40	31147.59	33452.55
	58"(1473mm)	96	TACZ-5858-	SNH	D	25839.09	26613.78	26592.62	27367.31	31690.21	34242.13	31896.77	34448.69
29"(737mm)	46"(1168mm)	79	TACZ-4646-	SNH	C	\$ 25674.79	\$ 26306.68	\$ 26420.56	\$ 27052.45	\$ 30652.71	\$ 32734.23	\$30853.48	\$32935.00
	52"(1321mm)	93	TACZ-5252-	SNH	C	26001.36	26708.22	26770.43	27477.29	31437.71	33766.19	31655.88	33984.36
	58"(1473mm)	108	TACZ-5858-	SNH	C	26329.60	27115.00	27121.98	27907.38	32246.21	34833.41	32481.79	35068.99
30"(762mm)	46"(1168mm)	83	TACZ-4646-	SNH	G	\$ 25751.80	\$ 26383.69	\$ 26503.72	\$ 27135.61	\$ 30729.72	\$ 32811.24	\$30935.08	\$ 33016.60
	52"(1321mm)	97	TACZ-5252-	SNH	G	26090.08	26800.51	26866.12	27576.55	31548.26	33888.50	31771.64	34111.88
	58"(1473mm)	113	TACZ-5858-	SNH	G	26426.69	27212.09	27226.84	28012.24	32343.30	34930.50	32584.69	35171.89
Extended Range (Dual Stage)													
23"(584mm)	46"(1168mm)	68	TACZ-4646-	SNH	B	\$ 28093.29	\$ 28714.47	\$ 28802.08	\$ 29423.26	\$ 33005.72	\$ 35051.96	\$ 33178.87	\$ 35225.11
	52"(1321mm)	79	TACZ-5252-	SNH	B	28361.27	29060.99	29088.54	29788.26	33753.96	36058.92	33940.91	36245.87
	58"(1473mm)	91	TACZ-5858-	SNH	B	28627.56	29402.25	29373.33	30148.02	34478.68	37030.60	34679.45	37231.37
24"(610mm)	46"(1168mm)	72	TACZ-4646-	SNH	D	\$ 28171.98	\$ 28796.73	\$ 28886.93	\$ 29511.68	\$ 33106.24	\$ 35164.24	\$ 33283.98	\$ 35341.98
	52"(1321mm)	83	TACZ-5252-	SNH	D	28448.32	29148.04	29182.56	29882.28	33841.01	36145.97	34033.16	36338.12
	58"(1473mm)	96	TACZ-5858-	SNH	D	28724.66	29499.35	29478.19	30252.88	34575.78	37127.70	34782.34	37334.26
29"(737mm)	46"(1168mm)	79	TACZ-4646-	SNH	C	\$ 28560.36	\$ 29192.25	\$ 29306.13	\$ 29938.02	\$ 33538.28	\$ 35619.80	\$ 33739.05	\$ 35820.57
	52"(1321mm)	93	TACZ-5252-	SNH	C	28886.93	29593.79	29656.00	30362.86	34323.28	36651.76	34541.45	36869.93
	58"(1473mm)	108	TACZ-5858-	SNH	C	29215.17	30000.57	30007.55	30792.95	35131.78	37718.98	35367.36	37954.56
30"(762mm)	46"(1168mm)	83	TACZ-4646-	SNH	G	\$ 28637.37	\$ 29269.26	\$ 29389.29	\$ 30021.18	\$ 33615.29	\$ 35696.81	\$ 33820.65	\$ 35902.17
	52"(1321mm)	97	TACZ-5252-	SNH	G	28975.65	29686.08	29751.69	30462.12	34433.83	36774.07	34657.21	36997.45
	58"(1473mm)	113	TACZ-5858-	SNH	G	29312.26	30097.66	30112.41	30897.81	35228.87	37816.07	35470.26	38057.46

Planes Base for Two-Sided Benching

Electric Adjustment

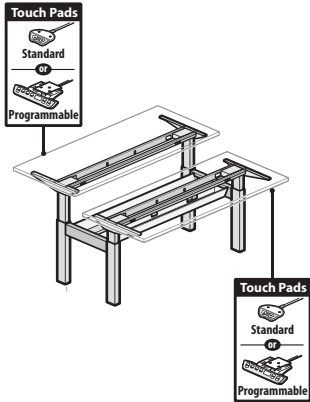

TMRA-2458-NH
Class TA

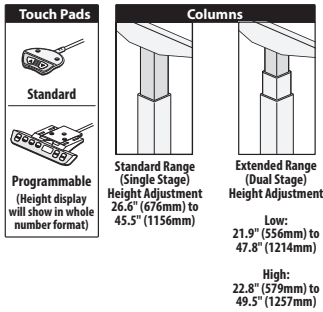

*Height range includes 1.18" (20mm) work surface



Features

- Includes:
 - Two sets of telescoping columns
 - Two crossbeams for back-to-back base connection
 - Fixed J-Rail frame system with End Brackets
 - Power and data channel with trough
 - Two control boxes
 - Two standard or programmable touch pad switches
 - Wire management clips
 - Two 9'(2743mm) long black power cord with NEMA 5-15P plug
 - Adjustable glides and hardware standard in black with 1"(25mm) of adjustment
- Electric Height Adjustment:
 - Speed: 1.4"(36mm) per second
 - Standard Range (Single Stage) telescoping columns feature 18.9"(480mm) of continuous adjustment.
 - Extended Range (Dual Stage) telescoping columns feature a range of 25.9"(658mm) - 26.7"(678mm) of continuous adjustment.
- Telescoping inner columns default to matching or coordinating paint colors. See Finish pages for details.
- Ships unassembled.
- Depth and width shown in nominal dimension.

Specification Tips

- Not designed for use with casters.
- See Specification Guide Product Applications for instructions on how to specify a powered benching run.
- 3- or 4-Circuit power In, Thru, and Out distribution options available. See **Electrical Components and Covers**.
- Select a work surface that accommodates 1"(25mm) of pinch point clearance on all sides and meets at least a NFPA class C flammability rating; refer to Specification Guide for application guidelines.
- Total lifting capacity of each table is 250 lbs. including surface; applied weight should be evenly distributed.
- Base Only Application may require approval of local authority having jurisdiction (AHJ); ensure compliance before placing orders and installation.
- See Product Application guidelines for use with attached worktools.
 - Monitor Arms
 - Screens
 - Suspended Storage
 - Horizontal and Vertical Wire management

To Order, Specify:

1) Product number, including:

1 Height Adjustment Actuator Options:

Standard Range
(Single Stage):

E Standard

R Programmable
(add **\$404.31** list)

Extended Range
(Dual Stage, Low):

P Standard

S Programmable
(add **\$404.31** list)

(Dual Stage, High):

Q Standard

T Programmable
(add **\$404.31** list)

2) Base trim color.

Planes Base for Two-Sided Benching

Electric Adjustment

Top Depth	Minimum Top Width	Maximum Top Width	Number	①	Trim A	B
Standard Range (Single Stage)						
24"(610mm)	46"(1168mm)	51"(1295mm)	TMRA-2446-NNNNH		\$ 8024.51	\$ 8151.50
	52"(1321mm)	57"(1448mm)	TMRA-2452-NNNNH		8183.81	8310.80
	58"(1473mm)	58"(1473mm)	TMRA-2458-NNNNH		8343.11	8470.10
	64"(1626mm)	69"(1753mm)	TMRA-2464-NNNNH		8502.41	8629.40
	70"(1778mm)	75"(1905mm)	TMRA-2470-NNNNH		8661.71	8788.70
30"(762mm)	46"(1168mm)	51"(1295mm)	TMRA-3046-NNNNH		\$ 8202.16	\$ 8329.15
	52"(1321mm)	57"(1448mm)	TMRA-3052-NNNNH		8361.46	8488.45
	58"(1473mm)	58"(1473mm)	TMRA-3058-NNNNH		8520.76	8647.75
	64"(1626mm)	69"(1753mm)	TMRA-3064-NNNNH		8680.06	8807.05
	70"(1778mm)	75"(1905mm)	TMRA-3070-NNNNH		8839.36	8966.35
Extended Range (Dual Stage)						
24"(610mm)	46"(1168mm)	51"(1295mm)	TMRA-2446-NNNNH		\$10330.55	\$10457.54
	52"(1321mm)	57"(1448mm)	TMRA-2452-NNNNH		10489.85	10616.84
	58"(1473mm)	58"(1473mm)	TMRA-2458-NNNNH		10649.15	10776.14
	64"(1626mm)	69"(1753mm)	TMRA-2464-NNNNH		10808.45	10935.44
	70"(1778mm)	75"(1905mm)	TMRA-2470-NNNNH		10967.75	11094.74
30"(762mm)	46"(1168mm)	51"(1295mm)	TMRA-3046-NNNNH		\$10508.20	\$ 10635.19
	52"(1321mm)	57"(1448mm)	TMRA-3052-NNNNH		10667.50	10794.49
	58"(1473mm)	58"(1473mm)	TMRA-3058-NNNNH		10826.80	10953.79
	64"(1626mm)	69"(1753mm)	TMRA-3064-NNNNH		10986.10	11113.09
	70"(1778mm)	75"(1905mm)	TMRA-3070-NNNNH		11145.40	11272.39

Planes LT Benching

Catalog Logic

TL RA - 30 58 - L J S N H R

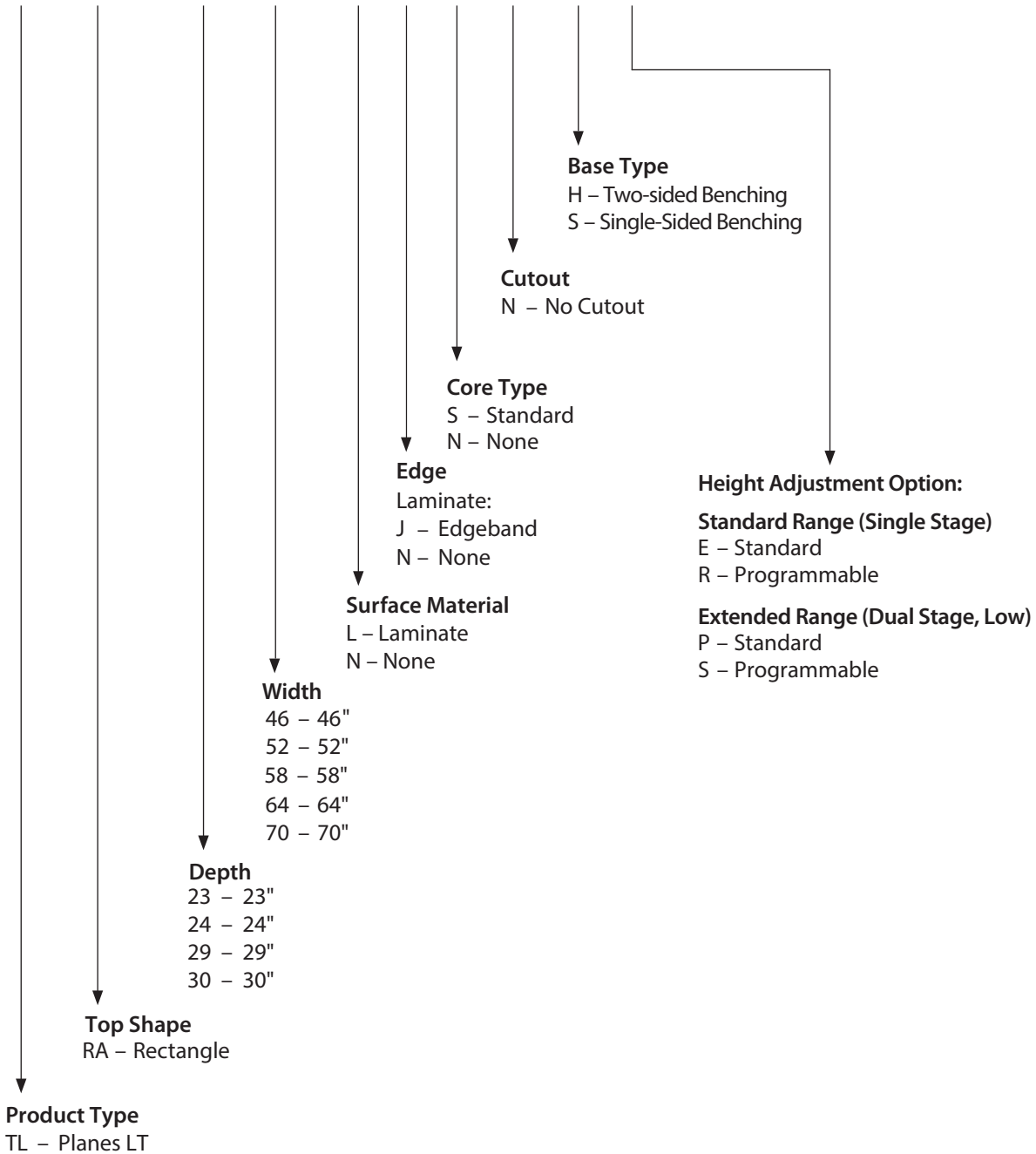

Planes LT Two-Sided Benching — Rectangular

Electric Adjustment

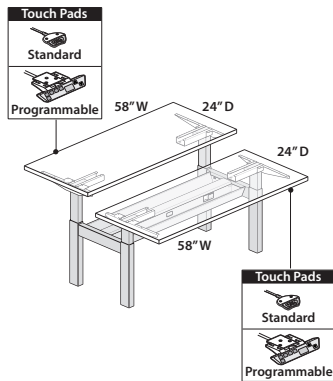

TLRA-2458-LJSNHE
Class TA

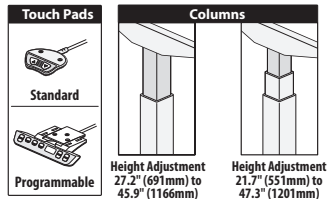

*Height range includes 1.18\"/>



Features

- Includes:
 - Two 1.18\"/>
- Electric Height Adjustment:
 - Speed: 1.4\"/>
- Worksurface:
 - High-Pressure Laminate (HPL) worksurface with 3mm edgeband
 - 3mm Edgeband on user edge and 1mm on remaining edges
- Base Assembly:
 - Telescoping inner columns default to matching or coordinating paint colors. See Finish pages for details.
 - Ships unassembled.
- Depth and width shown in nominal dimensions.

Specification Tips

- Not designed for use with casters.
- See Specification Guide Product Applications for instructions on how to specify a powered benching run.
- Select a worksurface that accommodates 1\"/>

To Order, Specify:

1) Product number, including:

1 Height Adjustment Options:

Standard Range (Single Stage):

E Standard

R Programmable
(add **\$403.48** list)

Extended Range (Dual Stage):

P Standard

S Programmable
(add **\$403.48** list)

2) Laminate surface color.

3) Edge trim color.

4) Base trim color.

Note: \$119.88 upcharge list for Grade B trim colors.

Planes LT Two-Sided Benching — Rectangular

Electric Adjustment

Depth	Width	Number	①	HPL		
				A	B	E
Standard Range (Single Stage)						
23"(584mm)	46"(1168mm)	TLRA-2346-LJSNH		\$ 5201.10	\$ 5315.20	\$ 5665.18
	52"(1321mm)	TLRA-2352-LJSNH		5267.31	5395.94	5790.81
	58"(1473mm)	TLRA-2358-LJSNH		5333.52	5476.68	5916.44
	64"(1626mm)	TLRA-2364-LJSNH		5399.74	5557.42	6042.07
	70"(1778mm)	TLRA-2370-LJSNH		5465.95	5638.17	6167.70
24"(610mm)	46"(1168mm)	TLRA-2446-LJSNH		\$ 5228.52	\$ 5347.46	\$ 5712.41
	52"(1321mm)	TLRA-2452-LJSNH		5297.50	5431.60	5843.39
	58"(1473mm)	TLRA-2458-LJSNH		5366.48	5515.74	5974.37
	64"(1626mm)	TLRA-2464-LJSNH		5435.46	5599.88	6105.35
	70"(1778mm)	TLRA-2470-LJSNH		5504.44	5684.02	6236.33
29"(737mm)	46"(1168mm)	TLRA-2946-LJSNH		\$ 5365.62	\$ 5508.78	\$ 5948.54
	52"(1321mm)	TLRA-2952-LJSNH		5448.44	5609.91	6106.27
	58"(1473mm)	TLRA-2958-LJSNH		5531.25	5711.05	6264.00
	64"(1626mm)	TLRA-2964-LJSNH		5614.06	5812.18	6421.73
	70"(1778mm)	TLRA-2970-LJSNH		5696.88	5913.31	6579.46
30"(762mm)	46"(1168mm)	TLRA-3046-LJSNH		\$ 5393.04	\$ 5541.05	\$ 5995.77
	52"(1321mm)	TLRA-3052-LJSNH		5478.62	5645.58	6158.85
	58"(1473mm)	TLRA-3058-LJSNH		5564.20	5750.11	6321.93
	64"(1626mm)	TLRA-3064-LJSNH		5649.78	5854.64	6485.01
	70"(1778mm)	TLRA-3070-LJSNH		5735.36	5959.17	6648.09
Extended Range (Dual Stage)						
23"(584mm)	46"(1168mm)	TLRA-2346-LJSNH		\$ 5448.96	\$ 5563.06	\$ 5913.04
	52"(1321mm)	TLRA-2352-LJSNH		5515.17	5643.80	6038.67
	58"(1473mm)	TLRA-2358-LJSNH		5581.38	5724.54	6164.30
	64"(1626mm)	TLRA-2364-LJSNH		5647.60	5805.28	6289.93
	70"(1778mm)	TLRA-2370-LJSNH		5713.81	5886.03	6415.56
24"(610mm)	46"(1168mm)	TLRA-2446-LJSNH		\$ 5476.38	\$ 5595.32	\$ 5960.27
	52"(1321mm)	TLRA-2452-LJSNH		5545.36	5679.46	6091.25
	58"(1473mm)	TLRA-2458-LJSNH		5614.34	5763.60	6222.23
	64"(1626mm)	TLRA-2464-LJSNH		5683.32	5847.74	6353.21
	70"(1778mm)	TLRA-2470-LJSNH		5752.30	5931.88	6484.19
29"(737mm)	46"(1168mm)	TLRA-2946-LJSNH		\$ 5613.48	\$ 5756.64	\$ 6196.40
	52"(1321mm)	TLRA-2952-LJSNH		5696.30	5857.77	6354.13
	58"(1473mm)	TLRA-2958-LJSNH		5779.11	5958.91	6511.86
	64"(1626mm)	TLRA-2964-LJSNH		5861.92	6060.04	6669.59
	70"(1778mm)	TLRA-2970-LJSNH		5944.74	6161.17	6827.32
30"(762mm)	46"(1168mm)	TLRA-3046-LJSNH		\$ 5640.90	\$ 5788.91	\$ 6243.63
	52"(1321mm)	TLRA-3052-LJSNH		5726.48	5893.44	6406.71
	58"(1473mm)	TLRA-3058-LJSNH		5812.06	5997.97	6569.79
	64"(1626mm)	TLRA-3064-LJSNH		5897.64	6102.50	6732.87
	70"(1778mm)	TLRA-3070-LJSNH		5983.22	6207.03	6895.95

Planes Single-Sided Benching — Rectangular

Electric Adjustment

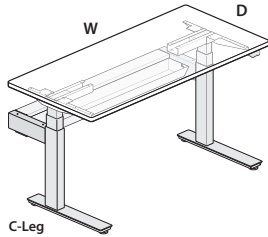

TLRA-2358-LJSNSP
Class TA

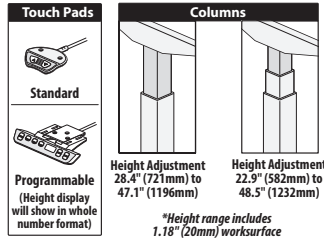

Features

- Includes:
 - 1.18”(30mm) thick rectangle worksurfaces
 - Telescoping base assemblies
 - Standard or programmable touch pad switches
 - Wire management clips
 - 9’(2743mm) long black power cord with NEMA 5-15P plug
 - Adjustable glides and hardware standard in black with 1”(25mm) of adjustment
- Electric Height Adjustment:
 - Speed: 1.4”(36mm) per second
 - Standard Range (Single Stage) telescoping columns feature 18.7”(475mm) of continuous adjustment.
 - Extended Range (Dual Stage) telescoping columns feature a range of 25.9”(658mm) - 26.7”(678mm) of continuous adjustment.
- Worksurface:
 - High-Pressure Laminate (HPL) worksurface with 3mm edgeband
 - 3mm Edgeband on user edge and 1mm on remaining edges
- Base Assembly:
 - Telescoping inner columns default to matching or coordinating paint colors. See Finish pages for details.
 - Ships unassembled.
- Depth and width shown in nominal dimensions.

Specification Tips

- Not designed for use with casters.
- See Specification Guide Product Applications for instructions on how to specify a powered run of benching.
- Single-sided bench unit cannot be used as a freestanding table. It must be attached to another bench of equal or greater size.
- Select a worksurface that accommodates 1”(25mm) of pinch point clearance on all sides and meets at least a NFPA class C flammability rating; refer to Specification Guide for application guidelines.
- 3- or 4-Circuit power In, Thru, and Out distribution options available. See **Electrical Components and Covers**.
- Total lifting capacity of each table is 250 lbs. including surface; applied weight should be evenly distributed.
- See Product Application guidelines for use with attached worktools.
 - Monitor Arms
 - Screens
 - Suspended Storage
 - Horizontal and Vertical Wire management
- Spacer Kit TS00-5E4D (eParts) is required when linking Single-Sided benching unit to a Two-Sided or Three-Sided Benching unit.
- Application may require approval of local authority having jurisdiction (AHJ); ensure compliance before placing orders and installation.

To Order, Specify:

1) Product number, including:

1 Height Adjustment Options:

Standard Range (Single Stage):

- E** Standard
- R** Programmable (add **\$201.74** list)

Extended Range (Dual Stage):

- P** Standard
- S** Programmable (add **\$201.74** list)

- 2) Laminate surface color.
- 3) Edge trim color.
- 4) Base trim color.

Note: **\$59.95** upcharge list for Grade B trim colors.

Planes Single-Sided Benching — Rectangular

Electric Adjustment

Depth	Width	Number	①	HPL		
				A	B	E
Standard Range (Single Stage)						
23"(584mm)	46"(1168mm)	TLRA-2346-LJSNS		\$ 3376.74	\$ 3433.95	\$ 3608.78
	52"(1321mm)	TLRA-2352-LJSNS		3409.84	3474.34	3671.60
	58"(1473mm)	TLRA-2358-LJSNS		3442.95	3514.73	3734.41
	64"(1626mm)	TLRA-2364-LJSNS		3476.06	3555.12	3797.23
	70"(1778mm)	TLRA-2370-LJSNS		3509.16	3595.51	3860.04
24"(610mm)	46"(1168mm)	TLRA-2446-LJSNS		\$ 3398.07	\$ 3457.71	\$ 3640.02
	52"(1321mm)	TLRA-2452-LJSNS		3432.56	3499.80	3705.51
	58"(1473mm)	TLRA-2458-LJSNS		3467.05	3541.89	3771.00
	64"(1626mm)	TLRA-2464-LJSNS		3501.54	3583.98	3836.49
	70"(1778mm)	TLRA-2470-LJSNS		3536.03	3626.07	3901.98
29"(737mm)	46"(1168mm)	TLRA-2946-LJSNS		\$ 3504.78	\$ 3576.56	\$ 3796.24
	52"(1321mm)	TLRA-2952-LJSNS		3546.19	3627.15	3875.11
	58"(1473mm)	TLRA-2958-LJSNS		3587.59	3677.74	3953.97
	64"(1626mm)	TLRA-2964-LJSNS		3629.00	3728.33	4032.84
	70"(1778mm)	TLRA-2970-LJSNS		3670.41	3778.92	4111.70
30"(762mm)	46"(1168mm)	TLRA-3046-LJSNS		\$ 3526.12	\$ 3600.32	\$ 3827.48
	52"(1321mm)	TLRA-3052-LJSNS		3568.91	3652.61	3909.02
	58"(1473mm)	TLRA-3058-LJSNS		3611.70	3704.90	3990.56
	64"(1626mm)	TLRA-3064-LJSNS		3654.49	3757.19	4072.10
	70"(1778mm)	TLRA-3070-LJSNS		3697.28	3809.48	4153.64
Extended Range (Dual Stage)						
23"(584mm)	46"(1168mm)	TLRA-2346-LJSNS		\$ 3544.72	\$ 3601.93	\$ 3776.76
	52"(1321mm)	TLRA-2352-LJSNS		3577.82	3642.32	3839.58
	58"(1473mm)	TLRA-2358-LJSNS		3610.93	3682.71	3902.39
	64"(1626mm)	TLRA-2364-LJSNS		3644.04	3723.10	3965.21
	70"(1778mm)	TLRA-2370-LJSNS		3677.14	3763.49	4028.02
24"(610mm)	46"(1168mm)	TLRA-2446-LJSNS		\$ 3566.05	\$ 3625.69	\$ 3808.00
	52"(1321mm)	TLRA-2452-LJSNS		3600.54	3667.78	3873.49
	58"(1473mm)	TLRA-2458-LJSNS		3635.03	3709.87	3938.98
	64"(1626mm)	TLRA-2464-LJSNS		3669.52	3751.96	4004.47
	70"(1778mm)	TLRA-2470-LJSNS		3704.01	3794.05	4069.96
29"(737mm)	46"(1168mm)	TLRA-2946-LJSNS		\$ 3672.76	\$ 3744.54	\$ 3964.22
	52"(1321mm)	TLRA-2952-LJSNS		3714.17	3795.13	4043.09
	58"(1473mm)	TLRA-2958-LJSNS		3755.57	3845.72	4121.95
	64"(1626mm)	TLRA-2964-LJSNS		3796.98	3896.31	4200.82
	70"(1778mm)	TLRA-2970-LJSNS		3838.39	3946.90	4279.68
30"(762mm)	46"(1168mm)	TLRA-3046-LJSNS		\$ 3694.10	\$ 3768.30	\$ 3995.46
	52"(1321mm)	TLRA-3052-LJSNS		3736.89	3820.59	4077.00
	58"(1473mm)	TLRA-3058-LJSNS		3779.68	3872.88	4158.54
	64"(1626mm)	TLRA-3064-LJSNS		3822.47	3925.17	4240.08
	70"(1778mm)	TLRA-3070-LJSNS		3865.26	3977.46	4321.62

Planes LT Three-Sided Benching

Catalog Logic

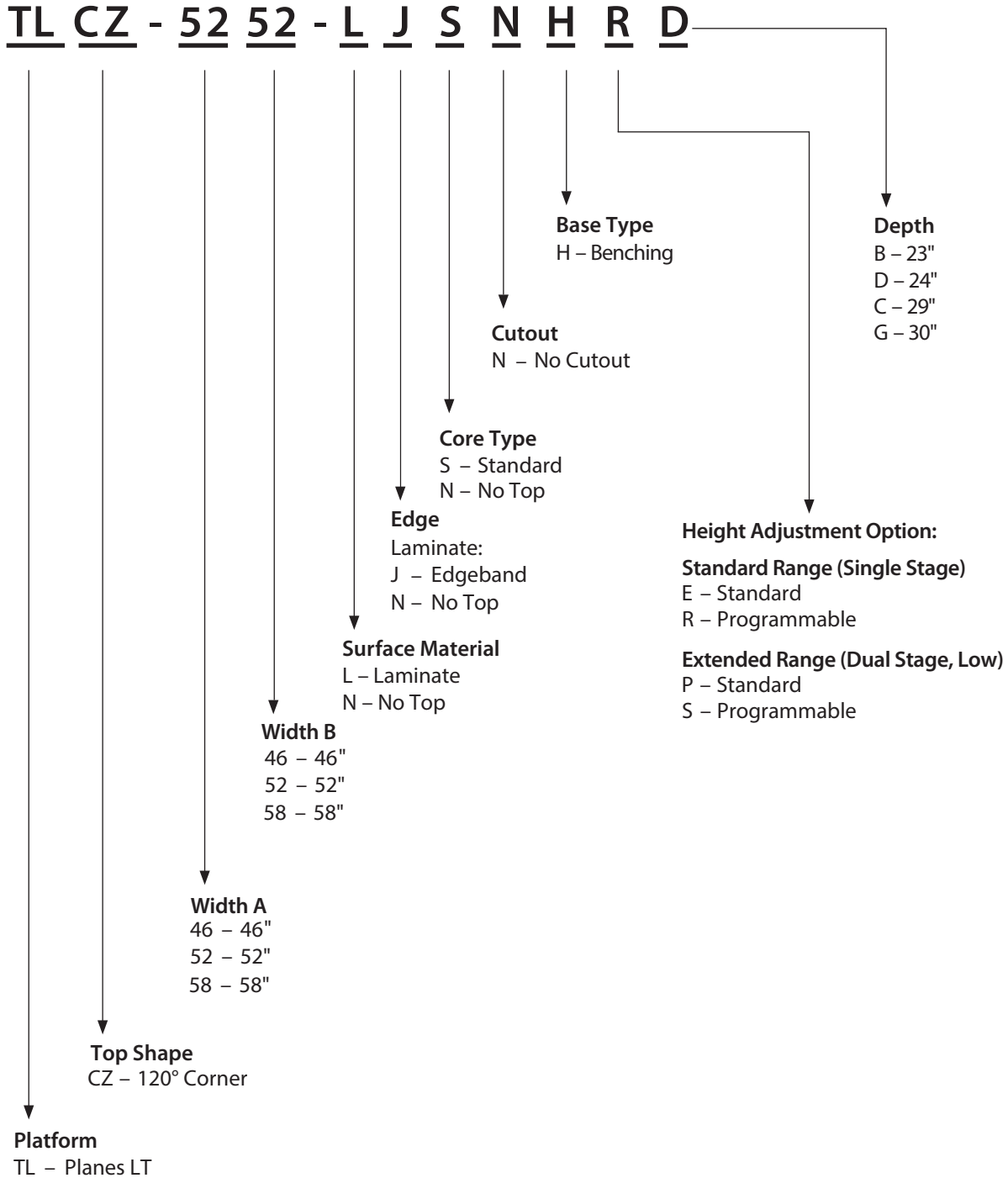

Planes LT Three-Sided Benching — 120°

Electric Adjustment

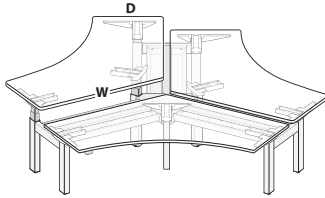

TLCZ-4646-LJSNHPB
Class TA

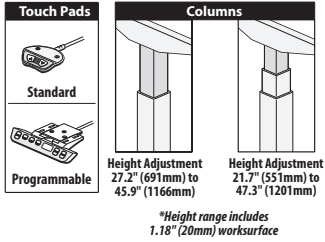

Features

- Includes:
 - Three 1.18" (30mm) thick 120 degree worksurfaces
 - 3 sets of Telescoping base assemblies
 - Three Power and data channels with troughs
 - Center connection tray and triangle cover
 - Three Standard or programmable touch pad switches
 - Wire management clips
 - Three 9'(2743mm) long black power cords with NEMA 5-15P plugs
 - Three 5'(1524mm) cable extensions (for top widths 52"(1321mm) or greater)
 - Adjustable glides and hardware standard in black with 1"(25mm) of adjustment
- Electric Height Adjustment:
 - Speed: 1.4"(36mm) per second
 - Standard Range (Single Stage) telescoping columns feature 18.7"(475mm) of continuous height adjustment.
 - Extended Range (Dual Stage) telescoping columns feature 25.6"(650mm) of continuous adjustment.
- Worksurface:
 - High-Pressure Laminate (HPL) worksurface with 3mm edgeband
 - 3mm Edgeband on user edge and 1mm on remaining edges
- Base Assembly:
 - Telescoping inner columns default to matching or coordinating paint colors. See Finish pages for details.
 - Ships unassembled.
- Depth and width shown in nominal dimensions.

Specification Tips

- Not designed for use with casters.
- See Specification Guide Product Applications for instructions on how to specify a powered run of benching.
- Select a worksurface that accommodates 1"(25mm) of pinch point clearance on all sides and meets at least a NFPA class C flammability rating; refer to Specification Guide for application guidelines.
- 3- or 4-Circuit power In, Thru, and Out distribution options available. See **Electrical Components and Covers**.
- Total lifting capacity of each table is 300 lbs. including surface; applied weight should be evenly distributed.
- See Product Application guidelines for use with attached worktools.
 - Monitor Arms
 - Screens
 - Suspended Storage
 - Horizontal and Vertical Wire management
- Spacer Kit TS00-5E4D (eParts) is required when linking Single-Sided benching unit to a Two-Sided or Three-Sided Benching unit.
- Application may require approval of local authority having jurisdiction (AHJ); ensure compliance before placing orders and installation.

To Order, Specify:

1) Product number, including:

1 Height Adjustment Options:

Standard Range (Single Stage):

- E** Standard
- R** Programmable (add **\$605.22** list)

Extended Range (Dual Stage):

- P** Standard
- S** Programmable (add **\$605.22** list)

2) Laminate surface color.

3) Edge trim color.

4) Base trim color.

Note: \$119.88 upcharge list for Grade B trim colors.

Planes LT Three-Sided Benching — 120°

Electric Adjustment

Depth	Width	Number	①	HPL	
				A	B
Standard Range (Single Stage)					
23"(584mm)	46"(1168mm)	TLCZ-4646-LJSNH	B	\$ 14519.63	\$15027.68
	52"(1321mm)	TLCZ-5252-LJSNH	B	14923.13	15487.76
	58"(1473mm)	TLCZ-5858-LJSNH	B	15326.63	15947.84
24"(610mm)	46"(1168mm)	TLCZ-4646-LJSNH	D	\$14529.24	\$15037.29
	52"(1321mm)	TLCZ-5252-LJSNH	D	14932.74	15497.37
	58"(1473mm)	TLCZ-5858-LJSNH	D	15336.24	15957.45
29"(737mm)	46"(1168mm)	TLCZ-4646-LJSNH	C	\$ 14836.67	\$15344.72
	52"(1321mm)	TLCZ-5252-LJSNH	C	15240.17	15804.80
	58"(1473mm)	TLCZ-5858-LJSNH	C	15643.67	16264.88
30"(762mm)	46"(1168mm)	TLCZ-4646-LJSNH	G	\$14846.28	\$15354.33
	52"(1321mm)	TLCZ-5252-LJSNH	G	15249.78	15814.41
	58"(1473mm)	TLCZ-5858-LJSNH	G	15653.28	16274.49
Extended Range (Dual Stage)					
23"(584mm)	46"(1168mm)	TLCZ-4646-LJSNH	B	\$15686.84	\$16194.89
	52"(1321mm)	TLCZ-5252-LJSNH	B	16090.34	16654.97
	58"(1473mm)	TLCZ-5858-LJSNH	B	16493.84	17115.05
24"(610mm)	46"(1168mm)	TLCZ-4646-LJSNH	D	\$15696.45	\$16204.50
	52"(1321mm)	TLCZ-5252-LJSNH	D	16099.95	16664.58
	58"(1473mm)	TLCZ-5858-LJSNH	D	16503.45	17124.66
29"(737mm)	46"(1168mm)	TLCZ-4646-LJSNH	C	\$16003.88	\$16511.93
	52"(1321mm)	TLCZ-5252-LJSNH	C	16407.38	16972.01
	58"(1473mm)	TLCZ-5858-LJSNH	C	16810.88	17432.09
30"(762mm)	46"(1168mm)	TLCZ-4646-LJSNH	G	\$ 16013.49	\$16521.54
	52"(1321mm)	TLCZ-5252-LJSNH	G	16416.99	16981.62
	58"(1473mm)	TLCZ-5858-LJSNH	G	16820.49	17441.70

Planes LT Base for Two-Sided Benching

Electric Adjustment

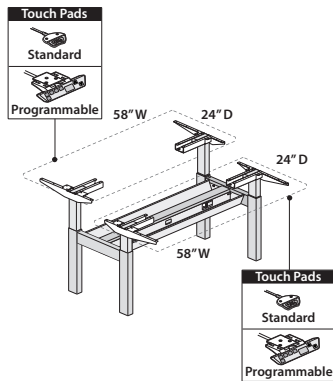

TLRA-2458-NNNNHE
Class TA

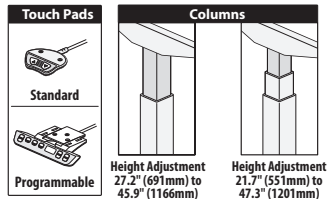

*Height range includes
1.18\"/>



Features

- Includes:
 - Two sets of telescoping columns with steel motor housing enclosure
 - Two crossbeams for back-to-back base connection
 - Two sets of End Brackets
 - Power and data channel with trough
 - Two control boxes
 - Two Standard or programmable touch pad switches
 - Wire management clips
 - Two 9'(2743mm) long black power cord with NEMA 5-15P plug
 - Adjustable glides and hardware standard in black with 1"(25mm) of adjustment
- Electric Height Adjustment:
 - Speed: 1.4"(36mm) per second
 - Standard Range (Single Stage) telescoping columns feature 18.7"(475mm) of continuous adjustment.
 - Extended Range (Dual Stage) telescoping columns feature 25.6"(650mm) of continuous adjustment.
- Telescoping inner columns default to matching or coordinating paint colors. See Finish pages for details.
- Ships unassembled.
- Depth and width shown in nominal dimensions.

Specification Tips

- Not designed for use with casters.
- See Specification Guide Product Applications for instructions on how to specify a powered benching run.
- 3- or 4-Circuit power In, Thru, and Out distribution options available. See **Electrical Components and Covers**.
- Select a worksurface that accommodates 1"(25mm) of pinch point clearance on all sides and meets at least a NFPA class C flammability rating; refer to Specification Guide for application guidelines.
- Total lifting capacity of each table is 250 lbs. including surface; applied weight should be evenly distributed.
- Base Only Application may require approval of local authority having jurisdiction (AHJ); ensure compliance before placing orders and installation.
- See Product Application guidelines for use with attached worktools.
 - Monitor Arms
 - Screens
 - Suspended Storage
 - Horizontal and Vertical Wire management
- Spacer Kit TSOO-5E4D (eParts) is required when linking Single-Sided benching unit to a Two-Sided or Three-Sided Benching unit.

To Order, Specify:

1) Product number, including:

1 Height Adjustment Options:
Standard Range (Single Stage):

E Standard

R Programmable
(add **\$403.48** list)

Extended Range (Dual Stage):

P Standard

S Programmable
(add **\$403.48** list)

2) Base trim color.

Planes LT Base for Two-Sided Benching

Electric Adjustment

Depth	Width	Number	①	Trim	
				A	B
Standard Range (Single Stage)					
23"(584mm)	46"(1168mm)	TLRA-2346-NNNNH		\$4683.57	\$4803.45
	52"(1321mm)	TLRA-2352-NNNNH		4683.57	4803.45
	58"(1473mm)	TLRA-2358-NNNNH		4683.57	4803.45
	64"(1626mm)	TLRA-2364-NNNNH		4683.57	4803.45
	70"(1778mm)	TLRA-2370-NNNNH		4683.57	4803.45
24"(610mm)	46"(1168mm)	TLRA-2446-NNNNH		\$4689.35	\$4809.23
	52"(1321mm)	TLRA-2452-NNNNH		4689.35	4809.23
	58"(1473mm)	TLRA-2458-NNNNH		4689.35	4809.23
	64"(1626mm)	TLRA-2464-NNNNH		4689.35	4809.23
	70"(1778mm)	TLRA-2470-NNNNH		4689.35	4809.23
29"(737mm)	46"(1168mm)	TLRA-2946-NNNNH		\$ 4718.25	\$4838.13
	52"(1321mm)	TLRA-2952-NNNNH		4718.25	4838.13
	58"(1473mm)	TLRA-2958-NNNNH		4718.25	4838.13
	64"(1626mm)	TLRA-2964-NNNNH		4718.25	4838.13
	70"(1778mm)	TLRA-2970-NNNNH		4718.25	4838.13
30"(762mm)	46"(1168mm)	TLRA-3046-NNNNH		\$4724.03	\$4843.91
	52"(1321mm)	TLRA-3052-NNNNH		4724.03	4843.91
	58"(1473mm)	TLRA-3058-NNNNH		4724.03	4843.91
	64"(1626mm)	TLRA-3064-NNNNH		4724.03	4843.91
	70"(1778mm)	TLRA-3070-NNNNH		4724.03	4843.91
Extended Range (Dual Stage)					
23"(584mm)	46"(1168mm)	TLRA-2346-NNNNH		\$ 4931.43	\$5051.31
	52"(1321mm)	TLRA-2352-NNNNH		4931.43	5051.31
	58"(1473mm)	TLRA-2358-NNNNH		4931.43	5051.31
	64"(1626mm)	TLRA-2364-NNNNH		4931.43	5051.31
	70"(1778mm)	TLRA-2370-NNNNH		4931.43	5051.31
24"(610mm)	46"(1168mm)	TLRA-2446-NNNNH		\$ 4937.21	\$5057.09
	52"(1321mm)	TLRA-2452-NNNNH		4937.21	5057.09
	58"(1473mm)	TLRA-2458-NNNNH		4937.21	5057.09
	64"(1626mm)	TLRA-2464-NNNNH		4937.21	5057.09
	70"(1778mm)	TLRA-2470-NNNNH		4937.21	5057.09
29"(737mm)	46"(1168mm)	TLRA-2946-NNNNH		\$ 4966.11	\$5085.99
	52"(1321mm)	TLRA-2952-NNNNH		4966.11	5085.99
	58"(1473mm)	TLRA-2958-NNNNH		4966.11	5085.99
	64"(1626mm)	TLRA-2964-NNNNH		4966.11	5085.99
	70"(1778mm)	TLRA-2970-NNNNH		4966.11	5085.99
30"(762mm)	46"(1168mm)	TLRA-3046-NNNNH		\$ 4971.89	\$5091.77
	52"(1321mm)	TLRA-3052-NNNNH		4971.89	5091.77
	58"(1473mm)	TLRA-3058-NNNNH		4971.89	5091.77
	64"(1626mm)	TLRA-3064-NNNNH		4971.89	5091.77
	70"(1778mm)	TLRA-3070-NNNNH		4971.89	5091.77

Planes LT Base for Single-Sided Benching

Electric Adjustment

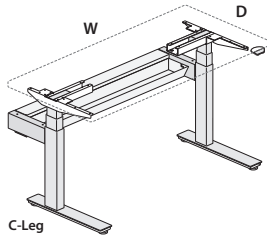

TLRA-2958-NNNNSP
Class TA

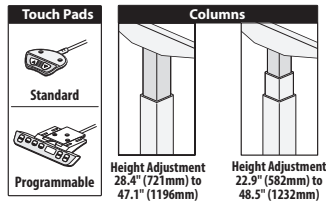

*Height range includes
1.18" (20mm) workspace



Features

- Includes:
 - Set of telescoping columns with steel motor housing enclosure
 - Set of End Brackets
 - Power and data channel with trough
 - Control boxes
 - Standard or programmable touch pad switches
 - Wire management clips
 - 9'(2743mm) long black power cord with NEMA 5-15P plug
 - Adjustable glides and hardware standard in black with 1"(25mm) of adjustment
- Electric Height Adjustment:
 - Speed: 1.4"(36mm) per second
 - Standard Range (Single Stage) telescoping columns feature 18.7"(475mm) of continuous adjustment.
 - Extended Range (Dual Stage) telescoping columns feature 25.6"(650mm) of continuous adjustment.
- Telescoping inner columns default to matching or coordinating paint colors. See Finish pages for details.
- Ships unassembled.
- Depth and width shown in nominal dimensions.

Specification Tips

- Not designed for use with casters.
- See Specification Guide Product Applications for instructions on how to specify a powered run of benching.
- Select a worksurface that accommodates 1"(25mm) of pinch point clearance on all sides and meets at least a NFPA class C flammability rating; refer to Specification Guide for application guidelines.
- 3- or 4-Circuit power In, Thru, and Out distribution options available. See **Electrical Components and Covers**.
- Total lifting capacity of each table is 300 lbs. including surface; applied weight should be evenly distributed.
- See Product Application guidelines for use with attached worktools.
 - Monitor Arms
 - Screens
 - Suspended Storage
 - Horizontal and Vertical Wire management
- Spacer Kit TS00-5E4D (eParts) is required when linking Single-Sided benching unit to a Two-Sided or Three-Sided Benching unit.
- Application may require approval of local authority having jurisdiction (AHJ); ensure compliance before placing orders and installation.

To Order, Specify:

1) Product number, including:

1 Height Adjustment Options:
Standard Range (Single Stage):

E Standard

R Programmable
(add **\$201.74** list)

Extended Range (Dual Stage):

P Standard

S Programmable
(add **\$201.74** list)

2) Base trim color.

Planes LT Base for Single-Sided Benching

Electric Adjustment

Depth	Width	Number	①	Trim	
				A	B
Standard Range (Single Stage)					
23"(584mm)	46"(1168mm)	TLRA-2346-NNNNS		\$ 3117.97	\$3177.92
	52"(1321mm)	TLRA-2352-NNNNS		3117.97	3177.92
	58"(1473mm)	TLRA-2358-NNNNS		3117.97	3177.92
	64"(1626mm)	TLRA-2364-NNNNS		3117.97	3177.92
	70"(1778mm)	TLRA-2370-NNNNS		3117.97	3177.92
24"(610mm)	46"(1168mm)	TLRA-2446-NNNNS		\$ 3128.49	\$3188.44
	52"(1321mm)	TLRA-2452-NNNNS		3128.49	3188.44
	58"(1473mm)	TLRA-2458-NNNNS		3128.49	3188.44
	64"(1626mm)	TLRA-2464-NNNNS		3128.49	3188.44
	70"(1778mm)	TLRA-2470-NNNNS		3128.49	3188.44
29"(737mm)	46"(1168mm)	TLRA-2946-NNNNS		\$ 3181.09	\$3241.04
	52"(1321mm)	TLRA-2952-NNNNS		3181.09	3241.04
	58"(1473mm)	TLRA-2958-NNNNS		3181.09	3241.04
	64"(1626mm)	TLRA-2964-NNNNS		3181.09	3241.04
	70"(1778mm)	TLRA-2970-NNNNS		3181.09	3241.04
30"(762mm)	46"(1168mm)	TLRA-3046-NNNNS		\$ 3191.61	\$3251.56
	52"(1321mm)	TLRA-3052-NNNNS		3191.61	3251.56
	58"(1473mm)	TLRA-3058-NNNNS		3191.61	3251.56
	64"(1626mm)	TLRA-3064-NNNNS		3191.61	3251.56
	70"(1778mm)	TLRA-3070-NNNNS		3191.61	3251.56
Extended Range (Dual Stage)					
23"(584mm)	46"(1168mm)	TLRA-2346-NNNNS		\$3285.95	\$3345.90
	52"(1321mm)	TLRA-2352-NNNNS		3285.95	3345.90
	58"(1473mm)	TLRA-2358-NNNNS		3285.95	3345.90
	64"(1626mm)	TLRA-2364-NNNNS		3285.95	3345.90
	70"(1778mm)	TLRA-2370-NNNNS		3285.95	3345.90
24"(610mm)	46"(1168mm)	TLRA-2446-NNNNS		\$3296.47	\$3356.42
	52"(1321mm)	TLRA-2452-NNNNS		3296.47	3356.42
	58"(1473mm)	TLRA-2458-NNNNS		3296.47	3356.42
	64"(1626mm)	TLRA-2464-NNNNS		3296.47	3356.42
	70"(1778mm)	TLRA-2470-NNNNS		3296.47	3356.42
29"(737mm)	46"(1168mm)	TLRA-2946-NNNNS		\$3349.07	\$3409.02
	52"(1321mm)	TLRA-2952-NNNNS		3349.07	3409.02
	58"(1473mm)	TLRA-2958-NNNNS		3349.07	3409.02
	64"(1626mm)	TLRA-2964-NNNNS		3349.07	3409.02
	70"(1778mm)	TLRA-2970-NNNNS		3349.07	3409.02
30"(762mm)	46"(1168mm)	TLRA-3046-NNNNS		\$3359.59	\$3419.54
	52"(1321mm)	TLRA-3052-NNNNS		3359.59	3419.54
	58"(1473mm)	TLRA-3058-NNNNS		3359.59	3419.54
	64"(1626mm)	TLRA-3064-NNNNS		3359.59	3419.54
	70"(1778mm)	TLRA-3070-NNNNS		3359.59	3419.54

Planes LT Base for Three-Sided 120° Benching

Electric Adjustment

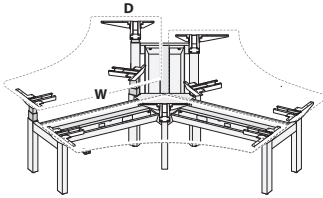

TLCZ-4646-NNNNHPB
Class TA

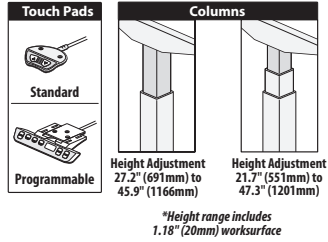

Features

- Includes:
 - Three sets of telescoping columns with steel motor housing enclosure
 - Three crossbeams for 3-sided connection
 - Three sets of end brackets
 - Three power and data channels with trough
 - Three control boxes
 - Three Standard or programmable touch pad switches
 - Center connection tray and triangle cover
 - Wire management clips
 - Three 9'(2743mm) long black power cords with NEMA 5-15P plug
 - Three 5'(1524mm) cable extensions (with top widths 52"(1321mm) or greater).
 - Adjustable glides and hardware standard in black with 1"(25mm) of adjustment.
- Electric Height Adjustment:
 - Speed: 1.4"(36mm) per second
 - Standard Range (Single Stage) telescoping columns feature 18.7"(475mm) of continuous adjustment.
 - Extended Range (Dual Stage) telescoping columns feature 25.6"(650mm) of continuous adjustment.
- Telescoping inner columns default to matching or coordinating paint colors. See Finish pages for details.
- Ships unassembled.
- Depth and width shown in nominal dimensions.

Specification Tips

- Not designed for use with casters.
- See Specification Guide Product Applications for instructions on how to specify a powered run of benching.
- Select a worksurface that accommodates 1"(25mm) of pinch point clearance on all sides and meets at least a NFPA class C flammability rating; refer to Specification Guide for application guidelines.
- 3- or 4-Circuit power In, Thru, and Out distribution options available. See **Electrical Components and Covers**.
- Total lifting capacity of each table is 300 lbs. including surface; applied weight should be evenly distributed.
- See Product Application guidelines for use with attached worktools.
 - Monitor Arms
 - Screens
 - Suspended Storage
 - Horizontal and Vertical Wire management
- Application may require approval of local authority having jurisdiction (AHJ); ensure compliance before placing orders and installation.

To Order, Specify:

1) Product number, including:

1 Height Adjustment Options:
Standard Range (Single Stage):

E Standard

R Programmable
(add **\$605.22** list)

Extended Range (Dual Stage):

P Standard

S Programmable
(add **\$605.22** list)

2) Base trim color.

Planes LT Base for Three-Sided 120° Benching

Electric Adjustment

Depth	Width	Number	①	Trim	
				A	B
Standard Range (Single Stage)					
23"(584mm)	46"(1168mm)	TLCZ-4646-NNNNH	B	\$ 1189.26	\$11309.14
	52"(1321mm)	TLCZ-5252-NNNNH	B	1189.26	11309.14
	58"(1473mm)	TLCZ-5858-NNNNH	B	1189.26	11309.14
24"(610mm)	46"(1168mm)	TLCZ-4646-NNNNH	D	\$ 1189.26	\$11309.14
	52"(1321mm)	TLCZ-5252-NNNNH	D	1189.26	11309.14
	58"(1473mm)	TLCZ-5858-NNNNH	D	1189.26	11309.14
29"(737mm)	46"(1168mm)	TLCZ-4646-NNNNH	C	\$ 11448.64	\$11568.52
	52"(1321mm)	TLCZ-5252-NNNNH	C	11448.64	11568.52
	58"(1473mm)	TLCZ-5858-NNNNH	C	11448.64	11568.52
30"(762mm)	46"(1168mm)	TLCZ-4646-NNNNH	G	\$ 11448.64	\$11568.52
	52"(1321mm)	TLCZ-5252-NNNNH	G	11448.64	11568.52
	58"(1473mm)	TLCZ-5858-NNNNH	G	11448.64	11568.52
Extended Range (Dual Stage)					
23"(584mm)	46"(1168mm)	TLCZ-4646-NNNNH	B	\$12442.93	\$12562.81
	52"(1321mm)	TLCZ-5252-NNNNH	B	12442.93	12562.81
	58"(1473mm)	TLCZ-5858-NNNNH	B	12442.93	12562.81
24"(610mm)	46"(1168mm)	TLCZ-4646-NNNNH	D	\$12442.93	\$12562.81
	52"(1321mm)	TLCZ-5252-NNNNH	D	12442.93	12562.81
	58"(1473mm)	TLCZ-5858-NNNNH	D	12442.93	12562.81
29"(737mm)	46"(1168mm)	TLCZ-4646-NNNNH	C	\$ 12702.31	\$12822.19
	52"(1321mm)	TLCZ-5252-NNNNH	C	12702.31	12822.19
	58"(1473mm)	TLCZ-5858-NNNNH	C	12702.31	12822.19
30"(762mm)	46"(1168mm)	TLCZ-4646-NNNNH	G	\$ 12702.31	\$12822.19
	52"(1321mm)	TLCZ-5252-NNNNH	G	12702.31	12822.19
	58"(1473mm)	TLCZ-5858-NNNNH	G	12702.31	12822.19

Upside Base for Two-Sided, Three-Sided 120° Benching Catalog Logic

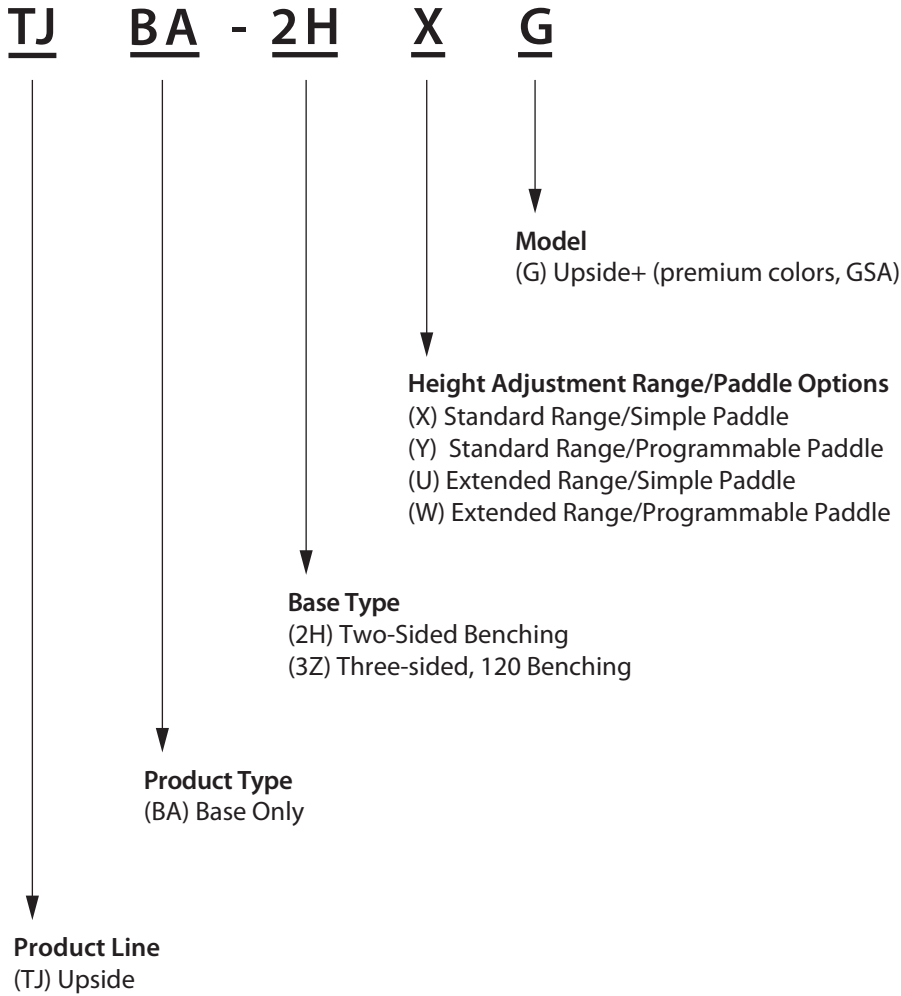

Upside Base for Single-Sided Benching

Catalog Logic

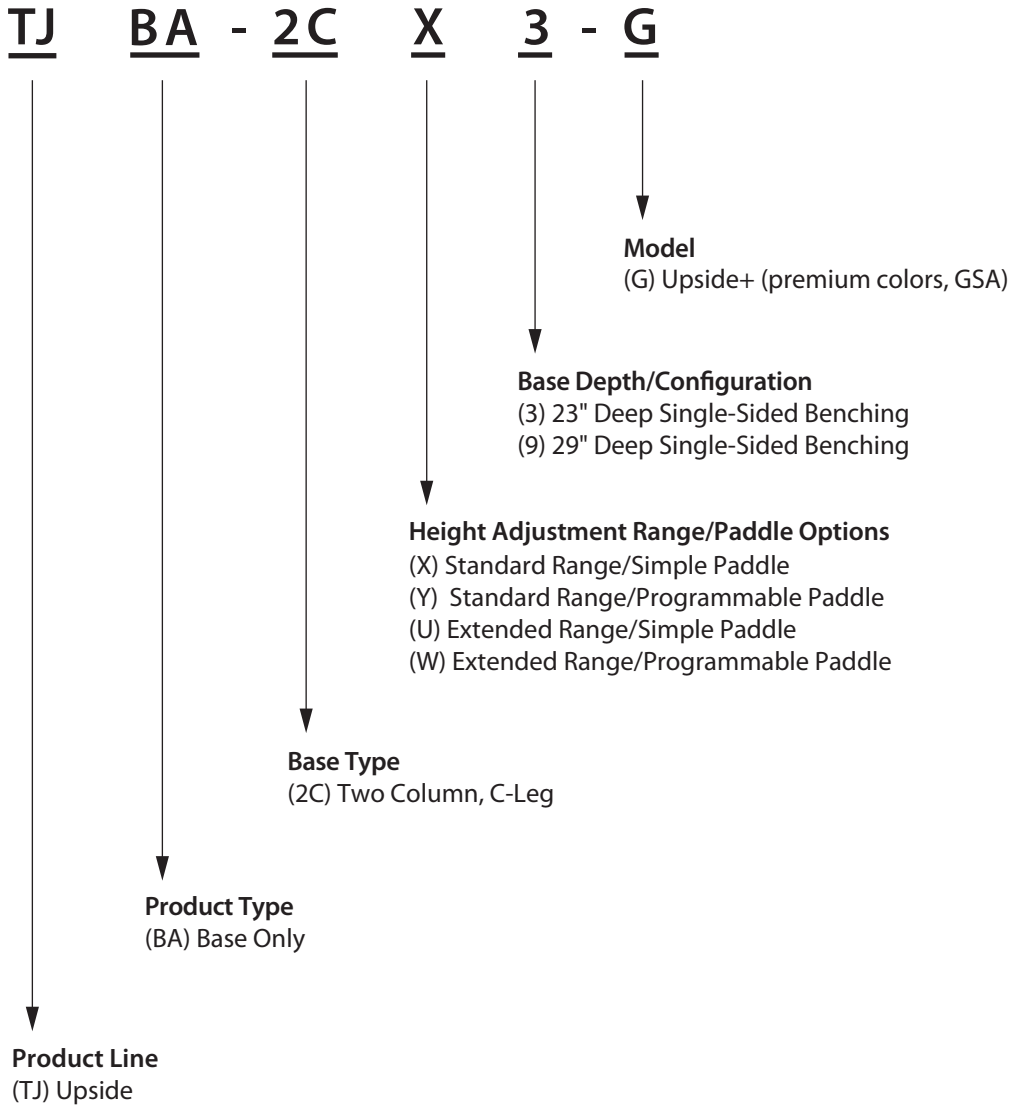

Upside Base for Two-Sided Benching

Electric

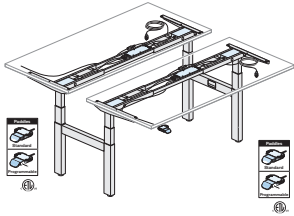

TJBA-2H
Class US



Features

- Includes:
 - Two sets of telescoping columns
 - Two crossbeams for benching connection
 - Two expandable width frames (40.18”(1021mm) to 71.7”(1821mm))
 - Two sets of arm brackets
 - Two control boxes containing built-in collision detection system
 - Two Simple or Programmable adjustment paddles
 - Wire management clips
 - Two 9’(2743mm) long black power cords with NEMA 5-15P plug
 - Adjustable glides and hardware standard in black with 0.5”(13mm) of adjustment
 - Screw fasteners for attaching electrical components and covers
- Electric Height adjustment:
 - Speed is 1.4”(36mm) per second
 - Standard Range (Single Stage) telescoping columns feature 19.2”(488mm) continuous adjustment range
 - Extended Range (Dual Stage) telescoping columns feature 26.1”(663mm) continuous adjustment range
- Telescoping inner columns will default to matching or coordinating paint finish based on specified trim color. See Finish pages for details.
- Ships unassembled.

Specification Tips

- Requires separately specified power and data channel.
- Not designed for use with casters.
- See Specification Guide/Product Applications for instructions on how to specify a powered benching run.
- Privacy Infill Panel Kits are available for use (see Electrical Components and Covers section of this price book).
- 3- or 4-Circuit power In, Thru, and Out distribution options available. See Electrical Components and Covers.
- Select a worksurface that accommodates 1”(25mm) pinch point of clearance on all sides and meets at least a NFPA class C flammability rating; refer to Specification Guide for application guidelines.
- Total lifting capacity of each table is 250 lbs. including surface; applied weight should be evenly distributed.
- Two-sided benching bases are width adjustable and may be used with all rectangular benching worksurface widths and depths.
- Application may require approval of local authority having jurisdiction (AHJ); ensure compliance before placing orders and installation.
- See Product Application guidelines for use with attached worktools and accessories.

To Order, Specify:

1) Product number, including:

1 Height Adjustment Range/
Paddle Options:

Standard Range:

Simple Paddle

Programmable (add \$210.00 list)

Extended Range:

Simple Paddle

Programmable (add \$210.00 list)

2) Base trim color.

	Number 1	Trim A B	
Standard Range			
	TJBA-2H <input type="checkbox"/> G	\$3005.00	\$ 3115.00
Extended Range			
	TJBA-2H <input type="checkbox"/> G	\$3309.00	\$3419.00

Upside Base for Single-Sided Benching

Electric

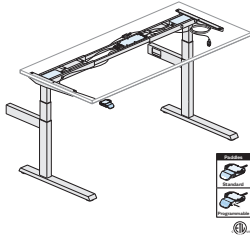

TJBA-3C
Class US



Features

- Includes:
 - Set of telescoping columns and control box with built-in collision detection
 - Expandable width frame (40.18"(1021mm) to 71.7"(1821mm))
 - Set of arm brackets and C-Leg configuration
 - Two crossbeams for power and data channel attachment for benching
 - Simple or Programmable adjustment paddle
 - Wire management clips
 - 9'(2743mm) long black power cords with NEMA 5-15P plug
 - Adjustable glides and hardware standard in black with 0.5"(13mm) of adjustment
 - Screw fasteners for attaching electrical components and covers
- Electric Height adjustment:
 - Speed is 1.4"(36mm) per second
 - Standard Range (Single Stage) telescoping columns feature 19.2"(488mm) continuous adjustment range
 - Extended Range (Dual Stage) telescoping columns feature 26.1"(663mm) continuous adjustment range
- Available in a variety of paint trim colors.
- Telescoping inner columns will default to matching or coordinating paint finish based on specified trim color. See Finish pages for details.
- Depth and width shown in nominal dimensions.
- Ships unassembled.

Specification Tips

- Requires separately specified power and data channel.**
- Single-sided benching unit cannot be used as a freestanding table. Attachment to another benching unit is required.
- Privacy Infill Panel Kits are not designed to be used with single-sided benching.
- Not for use with casters.
- See Specification Guide/Product Applications for instructions on how to specify a powered benching run.
- 3- or 4-Circuit power In, Thru, and Out distribution options available. See Electrical Components and Covers.
- Select a worksurface that accommodates 1"(25mm) of pinch point clearance on all sides and meets at least a NFPA class C flammability rating; refer to Specification Guide for application guidelines.
- 23"(584mm)D Single-sided Benching Base for use with 23"(584mm) or 24"(610mm) worksurface for benching depths.
- 29"(737mm)D Single-sided Benching Base for use with 29"(737mm) or 30"(762mm) worksurface for benching depths.
- Total lifting capacity is 250 lbs. including surface; applied weight should be evenly distributed.
- Application may require approval of local authority having jurisdiction (AHJ); ensure compliance before placing orders and installation.
- See Product Application guidelines for use with attached worktools and accessories.
- Power and data channel width must align with specified worksurface width.

To Order, Specify:

1) Product number, including:

1 Height Adjustment Range/ Paddle Options:

Standard Range:

X Simple Paddle

Y Programmable (add
\$105.00 list)

Extended Range:

U Simple Paddle

W Programmable (add
\$105.00 list)

2) Base trim color.

Depth	Number ①	Trim	
		A	B
23"(584mm)			
Standard Range	TJBA-2C 3-G	\$1628.00	\$1683.00
Extended Range	TJBA-2C 3-G	1780.00	1835.00
29"(737mm)			
Standard Range	TJBA-2C 9-G	\$1628.00	\$1683.00
Extended Range	TJBA-2C 9-G	1780.00	1835.00

Upside Base for Three-Sided 120° Benching

Electric

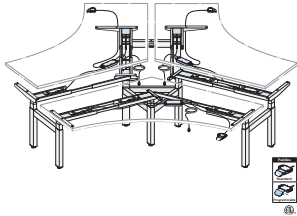

TJBA-3Z
Class US

Features

- Includes:
 - Three sets of telescoping columns
 - Three crossbeams for benching connection
 - Three expandable width frames (40.18”(1021mm) to 71.7”(1821mm))
 - Three sets of arm brackets
 - Three control boxes containing built-in collision detection system
 - Three Simple or Programmable adjustment paddles
 - Wire management clips
 - Three 9’(2743mm) long black power cords with NEMA 5-15P plug
 - Three 5’(1524mm) cable extensions
 - Adjustable glides and hardware standard in black with 0.5”(13mm) of adjustment
 - Screw fasteners for attaching electrical components and covers
- Electric Height adjustment:
 - Speed is 1.4”(36mm) per second
 - Standard Range (Single Stage) telescoping columns feature 19.2”(488mm) continuous adjustment range
 - Extended Range (Dual Stage) telescoping columns feature 26.1”(663mm) continuous adjustment range
- Telescoping inner columns will default to matching or coordinating paint finish based on specified trim color. See Finish pages for details.
- Ships unassembled.

Specification Tips

- **Requires separately specified power and data channel.**
- Not designed for use with casters.
- See Specification Guide/Product Applications for instructions on how to specify a powered benching run.
- Privacy Infill Panel Kits are available for use (see Electrical Components and Covers section of this price book).
- 3- or 4-Circuit power In, Thru, and Out distribution options available. See Electrical Components and Covers.
- Select a worksurface that accommodates 1”(25mm) pinch point of clearance on all sides and meets at least a NFPA class C flammability rating; refer to Specification Guide for application guidelines.
- Three-sided 120° benching bases are width adjustable and may be used with all 120° benching worksurface widths.
- Total lifting capacity of each table is 330 lbs. including surface; applied weight should be evenly distributed.
- Application may require approval of local authority having jurisdiction (AHJ); ensure compliance before placing orders and installation.
- See Product Application guidelines for use with attached worktools and accessories.

To Order, Specify:

1) Product number, including:

1 Height Adjustment Range/ Paddle Options:

Standard Range:

Simple Paddle

Programmable (add **\$315.00** list)

Extended Range:

Simple Paddle

Programmable (add **\$315.00** list)

2) Base trim color.

	Number 1	Trim A B	
Standard Range	TJBA-3Z <input type="checkbox"/> G	\$7648.00	\$7813.00
Extended Range	TJBA-3Z <input type="checkbox"/> G	\$8248.00	\$8413.00

Upside Worksurface for Benching — Rectangular

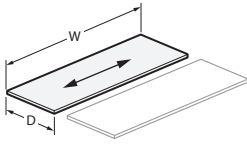

TRRA
Class US

Features

- Includes one 1.18" (30mm) thick high-pressure laminate (HPL) worksurface with pre-drilled for attachment to a separately specified single-sided or two-sided Upside Benching base.
- 3mm edgeband on user edge and 1mm on sides and back.
- Optional Belong Hatch cutout:
 - Available on worksurfaces 29" (737mm)D/30" (762mm)D and widths 58" (1473mm) or greater
 - Requires separately specified Belong Hatch
 - Refer to Specification Guide for cutout details
- Depth and width shown in nominal dimensions.

Specification Tips

- Back Screens can be mounted to 23" (584mm), 24" (610mm), and 29" (737mm) depth worksurfaces.
- Center Screens can be used on all worksurface depths.
- Refer to Specification Guide/Product Application for guidelines to attach monitor arms, screens and other worktools.
- For an integrated power solution, separately specify Belong Hatch, Belong Power Suite, or Belong Wire Management Tray (see Accessories Price List for numbers).
- Not intended for use on other height adjustable product lines.
- 24" (610mm) and 30" (762mm)D worksurfaces not intended for use on freestanding height adjustable tables due to pinch point clearance restrictions.
- Spacing between surfaces on two-sided applications will vary depending on surface depths.
- 23" (584mm)D Single-sided Benching Base for use with 23" (584mm) or 24" (610mm) worksurface for benching depths.
- 29" (737mm)D Single-sided Benching Base for use with 29" (737mm) or 30" (762mm) worksurface for benching depths.

To Order, Specify:

- 1) Product number, including:
 - ① **Cutout:**
 - N** None
 - H** Belong Hatch
- 2) Laminate surface color.
- 3) Edge trim color.

Depth	Width	Number ①	HPL		
			A	B	E
For use with Benching					
23" (584mm)	46" (1168mm)	TRRA-2346-LJSN CN	\$ 263.00	\$ 269.70	\$ 295.60
	52" (1321mm)	TRRA-2352-LJSN CN	297.80	308.52	349.96
	58" (1473mm)	TRRA-2358-LJSN CN	332.60	347.34	404.32
	64" (1626mm)	TRRA-2364-LJSN CN	367.40	386.16	458.68
	70" (1778mm)	TRRA-2370-LJSN CN	402.20	424.98	513.04
24" (610mm)	46" (1168mm)	TRRA-2446-LJSN CN	\$ 268.80	\$ 276.17	\$ 304.66
	52" (1321mm)	TRRA-2452-LJSN CN	303.60	314.99	359.02
	58" (1473mm)	TRRA-2458-LJSN CN	338.40	353.81	413.38
	64" (1626mm)	TRRA-2464-LJSN CN	373.20	392.63	467.74
	70" (1778mm)	TRRA-2470-LJSN CN	408.00	431.45	522.10
29" (737mm)	46" (1168mm)	TRRA-2946-LJSN CN	\$ 297.80	\$ 308.52	\$ 349.96
	52" (1321mm)	TRRA-2952-LJSN CN	332.60	347.34	404.32
	58" (1473mm)	TRRA-2958-LJS CN	367.40	386.16	458.68
	64" (1626mm)	TRRA-2964-LJS CN	402.20	424.98	513.04
	70" (1778mm)	TRRA-2970-LJS CN	437.00	463.80	567.40
30" (762mm)	46" (1168mm)	TRRA-3046-LJSN CN	\$ 303.60	\$ 314.99	\$ 359.02
	52" (1321mm)	TRRA-3052-LJSN CN	338.40	353.81	413.38
	58" (1473mm)	TRRA-3058-LJS CN	373.20	392.63	467.74
	64" (1626mm)	TRRA-3064-LJS CN	408.00	431.45	522.10
	70" (1778mm)	TRRA-3070-LJS CN	442.80	470.27	576.46

Upside Worksurface for Benching — 120° Corner — Wrap-Around

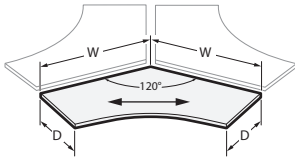

TRCZ
Class US

Features

- Includes one 1.18”(30mm) thick high-pressure laminate (HPL) worksurface with pre-drilled for attachment to a separately specified 3-leg 120° Benching base.
- 3mm edgeband on user edge and 1mm on sides and back.
- Depth and width shown in nominal dimensions.

Specification Tips

- Back Screens can be mounted to 23”(584mm), 24”(610mm), and 29”(737mm) depth worksurfaces.
- Center Screens can be used on all worksurface depths.
- Refer to Specification Guide/Product Application for guidelines to attach monitor arms, screens and other worktools.
- For an integrated power solution, separately specify Belong Hatch, Belong Power Suite, or Belong Wire Management Tray (see Accessories Price List for numbers).
- Not intended for use on other height adjustable product lines.
- 24”(610mm) and 30”(762mm)D worksurfaces not intended for use on freestanding height adjustable tables due to pinch point clearance restrictions.
- Three-sided benching base columns must be installed in the factory drilled locations on the benching worksurfaces.

To Order, Specify:

- 1) Product number.
- 2) Laminate surface color.
- 3) Edge trim color.

Depth	Width 1	Width 2	Number	HPL	
				A	B
For use with Benching					
23”(584mm)	46”(1168mm)	46”(1168mm)	TRCZ-4646-LJSNCBN	\$ 866.00	\$ 971.34
	52”(1321mm)	52”(1321mm)	TRCZ-5252-LJSNCBN	950.00	1067.10
	58”(1473mm)	58”(1473mm)	TRCZ-5858-LJSNCBN	1034.00	1162.86
24”(610mm)	46”(1168mm)	46”(1168mm)	TRCZ-4646-LJSNCDN	\$ 870.00	\$ 976.00
	52”(1321mm)	52”(1321mm)	TRCZ-5252-LJSNCDN	954.00	1071.76
	58”(1473mm)	58”(1473mm)	TRCZ-5858-LJSNCDN	1038.00	1167.52
29”(737mm)	46”(1168mm)	46”(1168mm)	TRCZ-4646-LJSNCCN	\$ 890.00	\$ 999.30
	52”(1321mm)	52”(1321mm)	TRCZ-5252-LJSNCCN	974.00	1095.06
	58”(1473mm)	58”(1473mm)	TRCZ-5858-LJSNCCN	1058.00	1190.82
30”(762mm)	46”(1168mm)	46”(1168mm)	TRCZ-4646-LJSNCGN	\$ 894.00	\$1003.96
	52”(1321mm)	52”(1321mm)	TRCZ-5252-LJSNCGN	978.00	1099.72
	58”(1473mm)	58”(1473mm)	TRCZ-5858-LJSNCGN	1062.00	1195.48

Upside Power and Data Channel for Benching

For use with Single-Sided or Two-Sided Applications

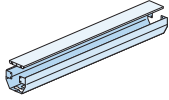

TJE A-R
Class US

Features

- Includes:
 - One power channel with cover
 - One data bracket
 - Requires Upside Single-Sided or Two-sided base for benching (separately specified)
 - Knockout on the bottom of the channel to accommodate base feed application
- Screw fasteners included in base assembly

Specification Tips

- Channel End Covers or Privacy Infill Panels Kits are available to cover the channel openings at the end of each run (separately specified). See Electrical Components and Covers.
- Additional data port brackets available to order.
- Power and data channel width must align with specified worksurface width.
- Requires separately specified power distribution components.

To Order, Specify:

- 1) Product number.
- 2) Trim color.

Worksurface Width	Channel Width	Number	Trim	
			A	B
For use with Single-Sided or Two-Sided Benching				
46" (1168mm)	35" (889mm)	TJE A-PC46-R	\$ 281.00	\$ 316.00
52" (1321mm)	41" (1041mm)	TJE A-PC52-R	317.00	352.00
58" (1473mm)	47" (1194mm)	TJE A-PC58-R	353.00	388.00
64" (1626mm)	53" (1346mm)	TJE A-PC64-R	389.00	424.00
70" (1778mm)	59" (1499mm)	TJE A-PC70-R	425.00	460.00

For use with Three-sided 120° Applications

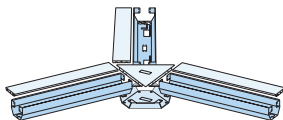

TJE A-Z
Class US

Features

- Includes:
 - Three power channels with covers
 - Three data brackets
 - Center Triangle Tray and cover features a knockout for top feed or base feed application
 - Center Triangle Tray and power connection cover
 - Requires Upside 3-sided 120° base for benching (separately specified)
 - Knockout on the bottom of the channel to accommodate base feed application
- Screw fasteners included in base assembly

Specification Tip

- Channel End Covers or Privacy Infill Panel Kits are available to cover the channel openings at the end of each run (separately specified). See Electrical Components and Covers.
- Power and data channel width must align with specified worksurface width.
- Requires separately specified power distribution components.

To Order, Specify:

- 1) Product number.
- 2) Trim color.

Worksurface Width	Channel Width	Number	Trim	
			A	B
For use with 3-Sided 120° Benching				
46" (1168mm)	34" (864mm)	TJE A-PC46-Z	\$ 833.00	\$903.00
52" (1321mm)	40" (1016mm)	TJE A-PC52-Z	941.00	1011.00
58" (1473mm)	46" (1168mm)	TJE A-PC58-Z	1049.00	1119.00

Data Port Bracket Kit

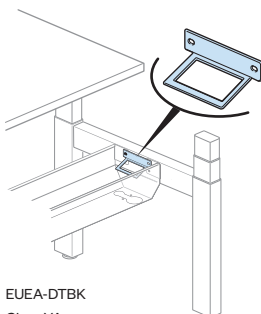

EUE A-DTBK
Class YA

Features

- Includes data port mounting bracket.
- Standard in black.

Specification Tips

- For use in Upside Benching power and data channels.
- Screw fastener included in base assembly.
- Accommodates most field supplied data faceplates that fit 1.38" (35mm) x 2.71" (69mm) opening.
- Application may require approval of local authority having jurisdiction (AHJ); ensure compliance before placing orders and installation.

To Order, Specify:

- 1) Product number.

Number	Price
EUE A-DTBK	\$19.00

Accessories

Upside, Planes and Planes LT

Caster Kit

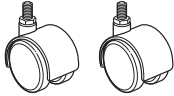

(2) Non-Locking

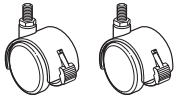

(2) Locking

TJ01-CSTR
Class US

Feature

- Includes four black casters (2-locking and 2 non-locking).

Specification Tips

- **For Upside Only.**
- Can replace glides on 23"(584mm) and 29"(737mm) tables.

To Order, Specify:

- 1) Product number.
(No finish specification required.)

Number	Price
TJ01-CSTR	\$81.71

Caster Kit

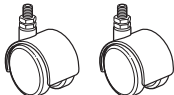

(2) Non-Locking

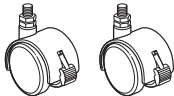

(2) Locking

TA01-CSTR
Class TA

Feature

- Includes four black casters (2-locking and 2 non-locking).

Specification Tips

- **For Planes and Planes LT only.**
- Can replace glides on 23"(584mm) and 29"(737mm) tables.

To Order, Specify:

- 1) Product number.
(No finish specification required.)

Number	Price
TA01-CSTR	\$90.88

Collision Sensor

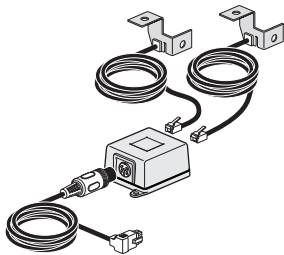

TA01-CLSN
Class TA

Features

- Includes external sensor, sensor unit cord, and either one or two connecting cables and attachment hardware.
- Provides increased pinch point and collision detection.
- Installs on bottom of table to surface and to J-rail.
- Use of sensor does not completely eliminate potential pinch point risks or collisions – user should be properly trained and use caution when operating.

Specification Tips

- Can only be installed on Planes or Planes Value Model Height Adjustable Tables and Benches with controller that is newer than 10-2016.
- Surfaces < 60"(1524mm) use one connecting cable.
- Surfaces > 60"(1524mm) use two connecting cables.
- Connection hardware is critical for optimal performance. See installation instructions.
- Very important for connecting cable to be securely fastened for optimal performance.

To Order, Specify:

- 1) Product number.
(No finish specification required.)

Description	Number	Price
One Sensor	TA01-CLSN-1	\$290.82
Two Sensors	TA01-CLSN-2	\$333.23

Benching Electrical Components and Covers

Planes and Planes LT

Base Feed Module — Concealed Hardwire Connection for New York City

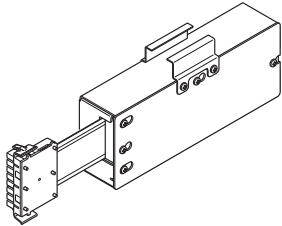

VZEB-0000-Y
Class YA



Features

- Includes one junction box with modular connector.
- For floor, column, or wall hardwire connections.
- Conduit for 3-circuit provides eight 12-gauge wires for up to three 20-amp circuits of power.
- Conduit for 4-circuit provides six 12-gauge and two 10-gauge wires for up to four 20-amp circuits of power.
- Conforms to New York City electrical code.
- Junction box has three 0.5"(13mm) knockouts.

Specification Tips

- For use with Planes LT and Planes Height-Adjustable Benching of 52"(1321mm) width or greater equipped with 3-circuit or 4-circuit (2+2 or 3+1) power components.
- Connector plugs into receptacle site on left side of a Power Distribution Assembly (PDA).
- Conduit and fittings for connection between building and junction box are supplied by local electricians.
- Do not mix 3-circuit with 4-circuit components. Do not mix 2+2 and 3+1 components. Components have unique polarity key and color coding (3-circuit=black, 2+2=blue and 3+1=green).

To Order, Specify:

- 1) Product number.
(No finish specification required.)

Description	Number	Price
3-Circuit	VZEB-0000-Y	\$708.75
4-Circuit, 2+2	VZEB-0000-YH2	\$708.75
4-Circuit, 3+1	VZEB-0000-YH4	\$708.75

Single Circuit Base Feed – Receptacle Connection — 20 amp

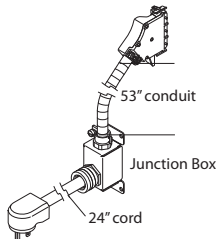

4TEB-20
Class TA



Features

- Includes one base feed, 24"(610mm) cord, junction box, 53"(1346mm) flexible conduit and 20 amp plug (NEMA 5-20P).
- For use with product equipped with 3-circuit or 4-circuit power components.
- Requires a 20 amp, 125 volt building receptacle (NEMA 5-20R) for plug-in (not included).
- Provides power to circuit #1 only.
- Attaches on the left hand side of the flex/jumper locations on a Power Distribution Assembly (PDA).
- Standard in charcoal trim color only.

Specification Tips

- **Not for use with isolated ground receptacles.**
- Not for use with power sources other than 120 volt 60 hertz.
- Junction box must be secured to furniture or architectural support.
- Do not mix 3-circuit with 4-circuit components. Do not mix 2+2 and 3+1 components. Components have unique polarity key and color coding (3-circuit=black, 2+2=blue and 3+1=green).
- Application may require approval of local authority having jurisdiction (AHJ); ensure compliance before placing orders and installation.

To Order, Specify:

- 1) Product number.
(No finish specification required.)

Description	Feed Length	Number	Price
3-Circuit (USA only)	24"(610mm)	4TEB-20	\$440.92
4-Circuit, 2+2 (USA only)		4TEB-20-2	440.92
4-Circuit, 3+1 (USA only)		4TEB-20-4	440.92

Benching Electrical Components and Covers

Planes and Planes LT

Single Circuit Base Feed – Receptacle Connection — 15 amp

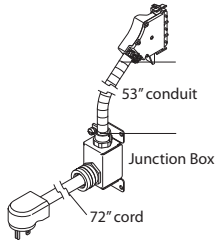

4TEB-154TEB-15
Class TA



Features

- Includes one base feed, 72”(1829mm) cord, junction box, 53”(1346mm) flexible conduit and 15 amp plug (NEMA 5-15P).
- For use with product equipped with 3-circuit or 4-circuit power components.
- Requires a 15 amp, 125 volt building receptacle (NEMA 5-15R) for plug-in (not included).
- Attaches on the left hand side of the flex/jumper locations on a Power Distribution Assembly (PDA).
- Provides power to circuit #1 only.
- Standard in charcoal trim color only.

Specification Tips

- **Not for use in USA due to electrical code restrictions.**
- **Not for use with isolated ground receptacles.**
- Not for use with power sources other than 120 volt 60 hertz.
- Junction box must be secured to furniture or architectural support.
- Do not mix 3-circuit with 4-circuit components. Do not mix 2+2 and 3+1 components. Components have unique polarity key and color coding (3-circuit=black, 2+2=blue and 3+1=green).
- Application may require approval of local authority having jurisdiction (AHJ); ensure compliance before placing orders and installation.

To Order, Specify:

- 1) Product number.
(No finish specification required.)

Description	Feed Length	Number	Price
3-Circuit (Canada only)	72”(1829mm)	4TEB-15	\$440.92
4-Circuit, 2+2 (Canada only)		4TEB-15-2	440.92
4-Circuit, 3+1 (Canada only)		4TEB-15-4	440.92

Wall Feed Field Wired 1 Port

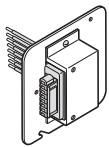

FBEW
Class YA



Features

- Includes 4.7”(119mm) junction box cover with one female modular power connector.
- For use with field supplied 4.7”(119mm) square junction box.
- Connector has integral latching system.
- UL listed Manufactured wiring system rated for 20 Amp 120V/208Y or 120/240V 60 Hz and for use in “other air handling spaces” per NEC Article 604.

Specification Tips

- For use with Internal Power Base AI Base Feed.
- Provides transition from building power to modular power distribution system. May be used with junction box in wall or column.
- Do not mix 3-circuit with 4-circuit components. Do not mix 2+2 and 3+1 components. Components have unique polarity key and color coding (3-circuit=rust and 4-circuit=black).

To Order, Specify:

- 1) Product number.
(No finish specification required.)

Description	Depth	Length/Width	Number	Price
3-Circuit	1.5”(38.1mm)	4.7”(119mm)	FBEW-0004-31	\$113.32
4-Circuit	1.5”(38.1mm)	4.7”(119mm)	FBEW-0004-41	\$113.32

Benching Electrical Components and Covers

Planes and Planes LT

Internal Power Base™ AI Base Feed

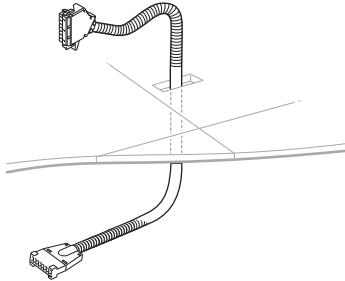

EUEJ-0064-3WF
EUEJ-0064-2WF
EUEJ-0064-4WF
Class YA



Features

- Includes connector assembly which consists of one Power Base connector head, galvanized 0.5”(13mm) flexible metal conduit, one Power Base AI connector head and a two port splitter.
- Conduit for 3-Circuit includes eight 12-gauge wires for up to three 20 amp circuits of power.
- Conduit for 4-Circuit includes six 12-gauge and two 10-gauge wires for up to four 20 amp circuits of power.
- For use with components equipped with power.
- Attaches at any receptacle site or right-hand jumper location and to a Wall Feed Field Wired 1 port.

Specification Tips

- **Not for use with power sources other than 120 volt 60 hertz.**
- A vertical base feed cover is a separately specified option.
- Exposed split tubing may be field supplied separately to cover exposed galvanized metal conduit.
- Do not mix 3-circuit with 4-circuit components. Do not mix 2+2 and 3+1 components. Components have unique polarity key and color coding (3-circuit = black; 2+2 = blue; 3+1 = green).

To Order, Specify:

- 1) Product number.
(No finish specification required.)

Description	Bench Feed Length	Number	Price
3-Circuit			
	64”(1626mm)	EUEJ-0064-3WF	\$ 276.75
	144”(3658mm)	EUEJ-0144-3WF	384.57
	300”(7620mm)	EUEJ-0300-3WF	918.29
4-Circuit, 2+2			
	64”(1626mm)	EUEJ-0064-2WF	\$303.70
	144”(3658mm)	EUEJ-0144-2WF	411.52
	300”(7620mm)	EUEJ-0300-2WF	945.24
4-Circuit, 3+1			
	64”(1626mm)	EUEJ-0064-4WF	\$303.70
	144”(3658mm)	EUEJ-0144-4WF	411.52
	300”(7620mm)	EUEJ-0300-4WF	945.24

Benching Electrical Components and Covers

Planes and Planes LT

Infeed Harness

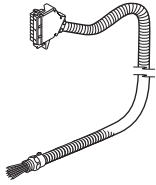

EUEH-0087-3
EUEH-0087-2
EUEH-0087-4
Class YA



Features

- Includes electrical harness in galvanized metal conduit.
- Conduit for 3-Circuit includes eight 12-gauge wires for up to three 20 amp circuits of power.
- Conduit for 4-Circuit includes six 12-gauge and two 10-gauge wires for up to four 20 amp circuits of power.
- For use with components equipped with power.
- Attaches at any receptacle site or right-hand jumper location.

Specification Tips

- **Not for use with power sources other than 120 volt 60 hertz.**
- Must be used with separately specified Top Feed Pole or Base Feed Cover to route power to the Power Distribution Assembly (PDA).
- A bench base feed cover is a separately specified option.
- Exposed split tubing may be field supplied separately to cover exposed galvanized metal conduit.
- Do not mix 3-circuit with 4-circuit components. Do not mix 2+2 and 3+1 components. Components have unique polarity key and color coding (3-circuit = black; 2+2 = blue; 3+1 = green).

To Order, Specify:

- 1) Product number.
(No finish specification required.)

Description	Feed Length	Number	Price
3-Circuit			
	87"(2210mm)	EUEH-0087-3	\$ 276.75
	180"(4572mm)	EUEH-00FO-3	427.66
	300"(7620mm)	EUEH-00WO-3	720.59
4-Circuit, 2+2			
	87"(2210mm)	EUEH-0087-2	\$303.70
	180"(4572mm)	EUEH-00FO-2	454.61
	300"(7620mm)	EUEH-00WO-2	747.54
4-Circuit, 3+1			
	87"(2210mm)	EUEH-0087-4	\$303.70
	180"(4572mm)	EUEH-00FO-4	454.61
	300"(7620mm)	EUEH-00WO-4	747.54

Base Feed Cover

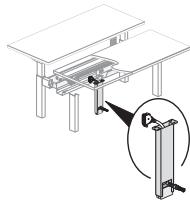

BSFD-S
Class TA

Features

- Includes two-piece base feed cover and attachment hardware.
- Optional base feed is used to conceal metal conduit and data cables.
- Base feed dimensions: 1.5"(38mm) x 4"(102mm).

Specification Tips

- **For use with Planes and Planes LT Height Adjustable Benching only.**
- Used to route power and data from floor or column to bottom of horizontal surface.
- Mounts under horizontal surface and attaches to floor.
- Floor attachment hardware is field supplied.
- Application may require approval of local authority having jurisdiction (AHJ); ensure compliance before placing orders and installation.

To Order, Specify:

- 1) Product number.
- 2) Trim color.

Description	Bottom of Surface To Floor	Number	Trim	
			A	B
For Planes Standard Range (Single Stage)				
	17.5"-18.5"(445mm-470mm)	TA01-BSFD-S	\$213.75	\$248.29
For Planes Extended Range (Dual Stage) and Planes LT Standard Range (Single Stage) and Extended Range (Dual Stage)				
	11.69"-13.25"(297mm-337mm)	TA01-BSFD-D	213.75	248.29

Benching Electrical Components and Covers

Planes and Planes LT

Top Feed Pole, End-of-Run

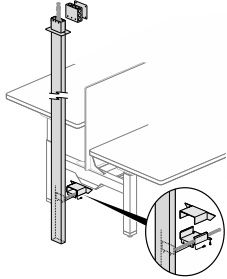

EAET-C000-SC
Class TA

Features

- Includes one electrical box, ceiling bezel plate, pole, transition tray for end-of-run and hardware.
- For connection to the electrical source located in space above a drop ceiling.
- Removable cover on poles provides access to pathway.
- End-of-Run Top Feed mounts to the floor and attaches to benching crossbeam and ceiling.
- Top feed pole dimensions: 1.5"(38mm) x 4"(102mm).

Specification Tips

- For use with Planes and Planes LT Height Adjustable Benching only.
- **Not for use with power sources other than 120 volt 60 hertz.**
- **Hardwire Applications:** Conduit and wiring are field installed.
- Power Infeed Harness is separately specified for Haworth modular power.
- Floor attachment hardware is field supplied.
- Application may require approval of local authority having jurisdiction (AHJ); ensure compliance before placing orders and installation.

To Order, Specify:

- 1) Product number.
- 2) Trim color.

Description	Ceiling Height	Pole Length	Pole Pieces	Number	Trim A	B
For Planes (Single Stage)						
	10'(3048mm)	126"(3200mm)	2	EAET-C000-SC	\$433.66	\$468.20
	12'(3658mm)	150"(3810mm)	2	EAET-E400-SC	445.16	479.70
For Planes (Dual Stage) and Planes LT (Single and Dual Stage)						
	10'(3048mm)	126"(3200mm)	2	EAET-C000-DC	\$433.66	\$468.20
	12'(3658mm)	150"(3810mm)	2	EAET-E400-DC	445.16	479.70

Top Feed Pole, Middle-of-Run

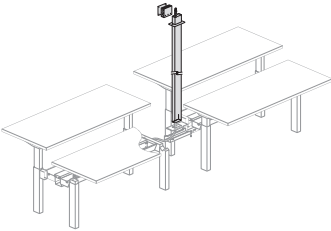

EAET-C00C-DC
Class TA

Features

- Includes one electrical box, ceiling bezel plate, pole and hardware.
- For connection to the electrical source located in space above a drop ceiling.
- For use with middle-of-run transition trays.
- Removable cover on poles provides access to pathway.
- Middle-of-Run Top Feed mounts to transition tray between connecting benching units and ceiling.
- Top feed pole dimensions: 1.5"(38mm) x 4"(102mm).

Specification Tips

- For use with Planes or Planes LT Height Adjustable Benching in the following applications:
 - Two-Sided Benching
 - 3-Sided 120° Benching
- Do not use with Single-Sided Height Adjustable Benching.
- **Not for use with power sources other than 120 volt 60 hertz.**
- See Product Details in Specification Guide for transition tray specification tips.
- **Hardwire Applications:** Conduit and wiring are field installed.
- Power Infeed Harness is separately specified for Haworth modular power applications.
- Application may require approval of local authority having jurisdiction (AHJ); ensure compliance before placing orders and installation.

To Order, Specify:

- 1) Product number.
- 2) Trim color.

Description	Ceiling Height	Pole Length	Pole Pieces	Number	Trim A	B
For Planes and Planes LT Height Adjustable Benching						
	10'(3048mm)	114"(2896mm)	1	EAET-C00C-DC	\$433.66	\$468.20
	12'(3658mm)	138"(3505mm)	2	EAET-E40C-DC	445.16	479.70

Benching Electrical Components and Covers

Planes and Planes LT

Utility Tray Power Retrofit Kit

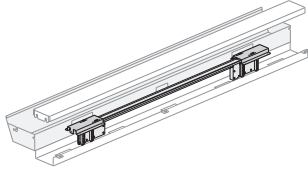

EUEK-3S
EUEK-2S
EUEK-4S
Class YA



Features

- Includes Power Distribution Assembly (PDA).
- Field installed.

Specification Tips

- Used for power distribution. Installs in the power and data channel.
- For use with Planes and Planes LT Benching only
- **Separately Specify:**
 - Receptacles
 - Jumpers
 - Power Infeeds
- Do not mix 3-circuit with 4-circuit components. Do not mix 2+2 and 3+1 components. Components have unique polarity key and color coding (3-circuit = black; 2+2 = blue; 3+1 = green).

To Order, Specify:

- 1) Product number.
- (No finish specification required.)

Description	Bench Width	Number	Price
3-Circuit			
	46"(1168mm)	EUEK-0042-3S	\$ 78.70
	52"(1321mm)	EUEK-0048-3S	88.12
	58"(1473mm)	EUEK-0054-3S	97.54
	64"(1626mm)	EUEK-0060-3S	106.96
	70"(1778mm)	EUEK-0066-3S	116.38
4-Circuit, 2+2			
	46"(1168mm)	EUEK-0042-2S	\$ 78.70
	52"(1321mm)	EUEK-0048-2S	88.12
	58"(1473mm)	EUEK-0054-2S	97.54
	64"(1626mm)	EUEK-0060-2S	106.96
	70"(1778mm)	EUEK-0066-2S	116.38
4-Circuit, 3+1			
	46"(1168mm)	EUEK-0042-4S	\$ 78.70
	52"(1321mm)	EUEK-0048-4S	88.12
	58"(1473mm)	EUEK-0054-4S	97.54
	64"(1626mm)	EUEK-0060-4S	106.96
	70"(1778mm)	EUEK-0066-4S	116.38

Power/Data Cover

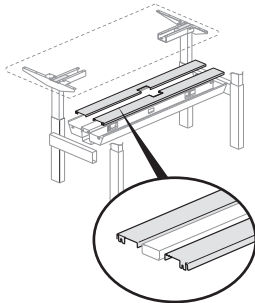

TVBC
Class ED

Feature

- Includes two covers and mounting hardware.

Specification Tips

- For use with Planes or Planes LT Height Adjustable Benching.
- Optional removable Benching Stretcher Cover provides access to power and data cable trough.

To Order, Specify:

- 1) Product number.
- 2) Trim color.

Application	Number	Price
For use with Rectangle Bench		
	TABC-0046-R	\$ 221.56
	TABC-0052-R	249.58
	TABC-0058-R	277.60
	TABC-0064-R	305.62
	TABC-0070-R	333.64
For use with 120° Bench		
	TABC-0046-Z	\$ 221.56
	TABC-0052-Z	249.58
	TABC-0058-Z	277.60

Benching Electrical Components and Covers

Planes and Planes LT

Jumper

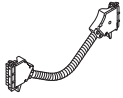

EUEJ-0018-3
EUEJ-0024-2
EUEJ-0024-4
Class YA



Features

- For use with power components.
- Jumpers cannot be coupled together.
- Field installed.

Specification Tips

- **Jumpers are used to connect power distribution assemblies between linked benching units.**
- Do not mix 3-circuit with 4-circuit components. Do not mix 2+2 and 3+1 components. Components have unique polarity key and color coding (3-circuit = black; 2+2 = blue; 3+1 = green).
- Use one 28"(711mm) jumper to connect between two in-line benching units.
- Use two 36"(914mm) jumpers to connect the Power Distribution assemblies within a 120° benching unit.

To Order, Specify:

- 1) Product number.
(No finish specification required.)

Description	Actual Length	Number	Price
3-Circuit	28"(711.2mm)	EUEJ-0028-3	\$173.55
4-Circuit, 2+2	28"(711.2mm)	EUEJ-0028-2	\$184.39
4-Circuit, 3+1	28"(711.2mm)	EUEJ-0028-4	\$184.39
3-Circuit	36"(914.4mm)	EUEJ-0036-3	\$187.95
4-Circuit, 2+2	36"(914.4mm)	EUEJ-0036-2	\$198.79
4-Circuit, 3+1	36"(914.4mm)	EUEJ-0036-4	\$198.79

Transition Tray

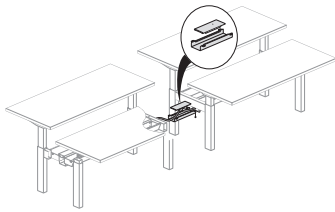

TA01-HBTT-M
Class TA

Features

- Includes tray, cover and mounting hardware.
- Conceals and routes power and data cables between connecting benching units.
- Mounts to crossbeams between two in-line benching units.
- Creates a 2"(51mm) pinch point clearance between in-line worksurfaces.
- Removable cover provides access to power and data cable pathway.

Specification Tips

- Required to link two or more, two-sided or three-sided 120 benching units together when routing power and data through channel/troughs.
- Separately specified Jumper is required to link power distribution assemblies between benching units.
- For use with Planes or Planes LT Height Adjustable Benching Only.
- Not for use in single-sided benching applications.
- Cannot be used to link Planes to Planes LT benching.
- Cannot be used to link single-sided benching units together.
- **Not for use with Top Feed, Middle-of-Run POWER IN applications.**
- Can be used with Center Screens.
- Application may require approval of local authority having jurisdiction (AHJ); ensure compliance before placing orders and installation.

To Order, Specify:

- 1) Product number.
- 2) Trim color.

Length	Width	Depth	Number	Trim	
				A	B
14"(356mm)	4"(102mm)	1.5"(38mm)	TA01-HBTT-M	\$194.72	\$210.93

Benching Electrical Components and Covers

Planes and Planes LT

Transition Tray – Asymmetrical

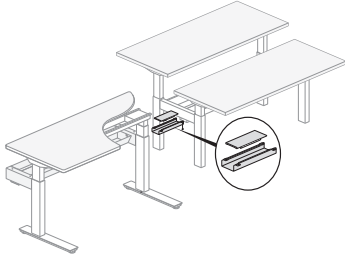

TA01-HBTT-MA
Class TA

Features

- Includes tray, cover and mounting hardware.
- Conceals and routes power and data cables between connecting benching units.
- Mounts to crossbeams between two in-line benching units.
- Creates a 2”(51mm) pinch point clearance between in-line worksurfaces.
- Removable cover provides access to power and data cable pathway.

Specification Tips

- Required to link a single-sided benching unit to another single-sided, two-sided (Planes Only), or 3-sided 120 (Planes Only) benching unit, when routing power and data through channel/troughs.
- Separately specified Jumper is required to link power distribution assemblies between benching units.
- For use with Planes or Planes LT Height Adjustable Benching Only.
- Can be used with Center Screens.
- Cannot be used to link Planes to Planes LT benching.
- Spacer Kit TS00-5E4D (eParts) is required when linking Single-Sided benching unit to a Two-Sided or Three-Sided Benching unit.
- Application may require approval of local authority having jurisdiction (AHJ); ensure compliance before placing orders and installation.

To Order, Specify:

- 1) Product number.
- 2) Trim color.

Length	Width	Depth	Number	Trim	
				A	B
14”(356mm)	4”(102mm)	1.5”(25mm)	TA01-HBTT-MA	\$194.72	\$210.93

Transition Tray — For use with Middle-of-Run, Top Feed

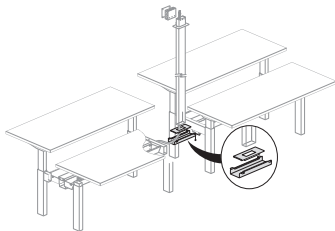

TA01-HBTT-MT

Features

- Includes tray, cover and mounting hardware.
- Conceals and routes power and data cables between connecting benching units.
- Mounts to crossbeams between two in-line benching units and to bottom of top feed pole in a middle-of-run application.
- Creates a 2”(51mm) pinch point clearance between in-line worksurfaces.
- Top feed fits through hole in tray cover; snap in cover provides access to power and data cable pathway.

Specification Tips

- Required to link two or more, two-sided or three-sided 120 benching units together when routing power and data through channel/troughs.
- Separately specified Jumper is required to link power distribution assemblies between benching units.
- For use with Planes or Planes LT Height Adjustable Benching Only.
- Spacer Kit TS00-5E4D (eParts) is required when linking Single-Sided benching unit to a Two-Sided or Three-Sided Benching unit.
- **NOT FOR USE WITH CENTER SCREENS.**
- Cannot be used to link Planes to Planes LT benching.
- Cannot be used to link single-sided benching units together.
- Application may require approval of local authority having jurisdiction (AHJ); ensure compliance before placing orders and installation.

To Order, Specify:

- 1) Product number.
- 2) Trim color.

Length	Width	Depth	Number	Trim	
				A	B
14”(356mm)	4”(102mm)	1.5”(38mm)	TA01-HBTT-MT	\$194.72	\$210.93

Benching Electrical Components and Covers

Planes and Planes LT

Transition Tray — For use with Center Screens and Middle-of-Run, Top Feed

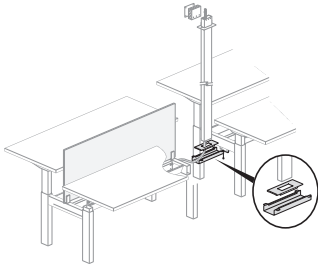

TA01-HBTT-MTS
Class TA

Features

- Includes tray, cover and mounting hardware.
- Conceals and routes power and data cables between connecting benching units.
- Mounts to crossbeams between two in-line benching units and to bottom of top feed pole in a middle-of-run application.
- Creates a 2" (51mm) pinch point clearance between in-line worksurfaces.
- For use with Height Adjustable Bench - Middle-of-Run Top Feed.
- Top Feed fits through hole in tray cover, snap in cover products access to power and cable pathway.

Specification Tips

- Required to link two or more, two-sided or three-sided 120 benching units together when routing power and data through channel/troughs.
- Separately specified Jumper is required to link power distribution assemblies between benching units.
- For use with Planes or Planes LT Height Adjustable Benching Only.
- **FOR USE WITH CENTER SCREENS.**
- Cannot be used to link Planes to Planes LT benching.
- Cannot be used to link single-sided benching units together.
- Application may require approval of local authority having jurisdiction (AHJ); ensure compliance before placing orders and installation.

To Order, Specify:

- 1) Product number.
- 2) Trim color.

Length	Width	Depth	Number	Trim	
				A	B
14"(356mm)	4"(102mm)	1.5"(38mm)	TA01-HBTT-MTS	\$198.89	\$215.10

Benching Electrical Components and Covers

Planes and Planes LT

Triplex Receptacle – 15 Amp

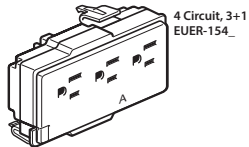
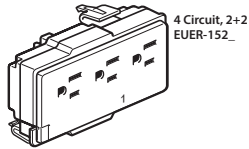
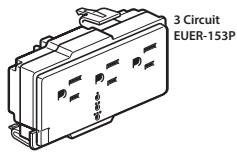
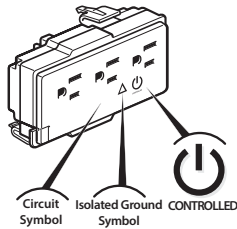

EUER-15
Class YA

Features

- Includes box of six receptacles, each receptacle has three 15 Amp outlets (NEMA 5-15R configuration).
- For use with benching equipped with power components.
- Receptacles are ground type specific.

Specification Tips

- Not for use with power sources other than 120 volt 60 hertz.
- Isolated ground receptacle not for use with single circuit base feed module.
- Triplexes for 3-Circuit are field programmable.
- Triplexes for 4-Circuit have fixed circuit access and are not field programmable. Specify appropriate number of receptacles for each circuit.
- Do not mix 3-circuit with 4-circuit components. Do not mix 2+2 and 3+1 components. Components have unique polarity key and color coding (3-circuit=black, 2+2=blue and 3+1=green).
- **Controlled receptacles are marked with a permanent symbol and the word CONTROLLED to comply with various energy code requirements including ASHRAE 90.1 and California Building Code Title 24 part 6.**
- **Circuit assignment and receptacle placement should be coordinated with a local electrician. Local electrician is responsible for circuit loading and code compliance.**
- **Consult with local authority having jurisdiction (AHJ) for requirements regarding controlled receptacles before placing orders and installation.**

Circuit Symbol	Circuit 1	Circuit 2	Circuit 3	Circuit 4
3 Circuit	0	00	000	NA
4 Circuit 2+2	1	2	3	4
4 Circuit 3+1	A	B	C	D

To Order, Specify:

- 1) Product number.

Description	Circuit Access	Receptacle Indicator	Ground Type	Receptacle without Controlled Symbol	Price	Receptacle with Controlled Symbol	Price
3-Circuit							
	Circuit 1-3	N/A	Common	EUER-153P-GSOS	\$ 177.24	EUER-153P-GCOS	\$ 181.68
	Circuit 1-3	N/A	Isolated	EUER-153P-ISOS	188.08	EUER-153P-ICOS	192.79
4-Circuit, 2+2							
	Circuit 1	1	Common	EUER-1521-GSOS	\$ 253.21	EUER-1521-GCOS	\$259.54
	Circuit 2	2		EUER-1522-GSOS	253.21	EUER-1522-GCOS	259.54
	Circuit 3	3		EUER-1523-GSOS	253.21	EUER-1523-GCOS	259.54
	Circuit 4	4		EUER-1524-GSOS	253.21	EUER-1524-GCOS	259.54
	Circuit 1	1	Isolated	EUER-1521-ISOS	\$264.05	EUER-1521-ICOS	\$270.66
	Circuit 2	2		EUER-1522-ISOS	264.05	EUER-1522-ICOS	270.66
	Circuit 3	3		EUER-1523-ISOS	264.05	EUER-1523-ICOS	270.66
	Circuit 4	4		EUER-1524-ISOS	264.05	EUER-1524-ICOS	270.66
4-Circuit, 3+1							
	Circuit 1	A	Common	EUER-1541-GSOS	\$ 253.21	EUER-1541-GCOS	\$259.54
	Circuit 2	B		EUER-1542-GSOS	253.21	EUER-1542-GCOS	259.54
	Circuit 3	C		EUER-1543-GSOS	253.21	EUER-1543-GCOS	259.54
	Circuit 4	D		EUER-1544-GSOS	253.21	EUER-1544-GCOS	259.54
	Circuit 1	A	Isolated	EUER-1541-ISOS	\$264.05	EUER-1541-ICOS	\$270.66
	Circuit 2	B		EUER-1542-ISOS	264.05	EUER-1542-ICOS	270.66
	Circuit 3	C		EUER-1543-ISOS	264.05	EUER-1543-ICOS	270.66
	Circuit 4	D		EUER-1544-ISOS	264.05	EUER-1544-ICOS	270.66

Benching Electrical Components and Covers

Planes and Planes LT

Triplex Receptacle – 20 Amp

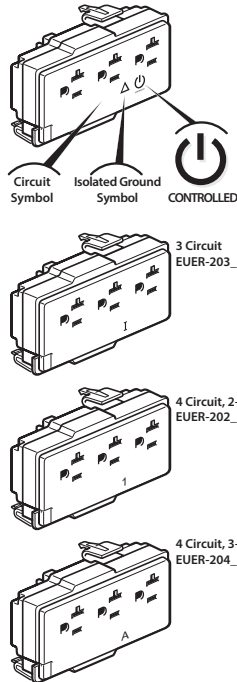

EUE-20
Class YA

Features

- Includes box of six receptacles, each receptacle has three 20 Amp outlets (NEMA 5-20R configuration).
- For use with benching equipped with power components.
- **Receptacles are circuit and ground type specific.**

Specification Tips

- Not for use with power sources other than 120 volt 60 hertz.
- Receptacles have fixed circuit access and are not field programmable. Specify appropriate number of receptacles for each circuit.
- Isolated ground receptacle not for use with single circuit base feed module.
- Do not mix 3-circuit with 4-circuit components. Do not mix 2+2 and 3+1 components. Components have unique polarity key and color coding (3-circuit=black, 2+2=blue and 3+1=green).
- **Controlled receptacles are marked with a permanent symbol and the word CONTROLLED to comply with various energy code requirements including ASHRAE 90.1 and California Building Code Title 24 part 6.**
- **Circuit assignment and receptacle placement should be coordinated with a local electrician. Local electrician is responsible for circuit loading and code compliance.**
- **Consult with local authority having jurisdiction (AHJ) for requirements regarding controlled receptacles before placing orders and installation.**

Circuit Symbol	Circuit 1	Circuit 2	Circuit 3	Circuit 4
3 Circuit	I	II	III	NA
4 Circuit 2+2	1	2	3	4
4 Circuit 3+1	A	B	C	D

To Order, Specify:

- 1) Product number.

Description	Circuit Access	Receptacle Indicator	Ground Type	Receptacle without Controlled Symbol	Price	Receptacle with Controlled Symbol	Price
3-Circuit							
	Circuit 1	1	Common	EUE-2031-GSOS	\$524.52	EUE-2031-GCOS	\$ 537.61
	Circuit 2	2		EUE-2032-GSOS	524.52	EUE-2032-GCOS	537.61
	Circuit 3	3		EUE-2033-GSOS	524.52	EUE-2033-GCOS	537.61
	Circuit 1	1	Isolated	EUE-2031-ISOS	\$535.35	EUE-2031-ICOS	\$548.72
	Circuit 2	2		EUE-2032-ISOS	535.35	EUE-2032-ICOS	548.72
	Circuit 3	3		EUE-2033-ISOS	535.35	EUE-2033-ICOS	548.72
4-Circuit, 2+2							
	Circuit 1	1	Common	EUE-2021-GSOS	\$524.52	EUE-2021-GCOS	\$ 537.61
	Circuit 2	2		EUE-2022-GSOS	524.52	EUE-2022-GCOS	537.61
	Circuit 3	3		EUE-2023-GSOS	524.52	EUE-2023-GCOS	537.61
	Circuit 4	4		EUE-2024-GSOS	524.52	EUE-2024-GCOS	537.61
	Circuit 1	1	Isolated	EUE-2021-ISOS	\$535.35	EUE-2021-ICOS	\$548.72
	Circuit 2	2		EUE-2022-ISOS	535.35	EUE-2022-ICOS	548.72
	Circuit 3	3		EUE-2023-ISOS	535.35	EUE-2023-ICOS	548.72
	Circuit 4	4		EUE-2024-ISOS	535.35	EUE-2024-ICOS	548.72
4-Circuit, 3+1							
	Circuit 1	A	Common	EUE-2041-GSOS	\$524.52	EUE-2041-GCOS	\$ 537.61
	Circuit 2	B		EUE-2042-GSOS	524.52	EUE-2042-GCOS	537.61
	Circuit 3	C		EUE-2043-GSOS	524.52	EUE-2043-GCOS	537.61
	Circuit 4	D		EUE-2044-GSOS	524.52	EUE-2044-GCOS	537.61
	Circuit 1	A	Isolated	EUE-2041-ISOS	\$535.35	EUE-2041-ICOS	\$548.72
	Circuit 2	B		EUE-2042-ISOS	535.35	EUE-2042-ICOS	548.72
	Circuit 3	C		EUE-2043-ISOS	535.35	EUE-2043-ICOS	548.72
	Circuit 4	D		EUE-2044-ISOS	535.35	EUE-2044-ICOS	548.72

Benching Electrical Components and Covers

Planes and Planes LT

Hardwire Kit

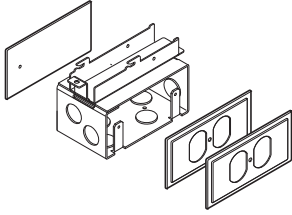

EUEE-UHDK
Class TA

Features

- Includes one electrical box with 0.5"(13mm) knockouts, two receptacle cover plates, one blank cover plate and mounting hardware.
- Attaches to Center Screen bracket.
- Attaches to PDA bracket.
- Field installed.

Specification Tip

- **Conduit, fittings, wiring and receptacles are field supplied.**

To Order, Specify:

- 1) Product number.
- 2) Trim color.

	Number	Trim A	B
	EUEE-UHDK	\$205.90	\$205.90

Benching Electrical Components and Covers

Upside

Base Feed Module — Hardwire Connection for New York City

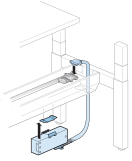

EUEB-0000-3HY
EUEB-0000-2HY
EUEB-0000-4HY



Class BC

Features

- Includes one junction box with modular flexible steel conduit connector and three 0.5”(13mm) knockouts.
- Conduit for 3-Circuit includes eight 12-gauge wires for up to three 20 amp circuits of power.
- Conduit for 4-Circuit includes six 12-gauge and two 10-gauge wires for up to four 20 amp circuits of power.
- For floor, column, or wall hardwire connections.
- Conforms to New York City electrical code.

Specification Tips

- **For use with 120 volt 60 hertz power sources only.**
- For use with Upside Benching 46”(1168mm) in width or greater.
- Module mounts to the underside of power and data channel.
- Conduit and fittings for connection between building and junction box are supplied by local electricians.
- Do not mix components from different wiring configurations. Unique polarity keys and colors are used for each wiring configuration. (3 circuit=black, 2+2=blue, 3+1=green).
- Application may require approval of local authority having jurisdiction (AHJ); ensure compliance before placing orders and installation.

To Order, Specify:

- 1) Product number.
(No finish specification required.)

Description	Conduit Length	Number	Price
3-Circuit	20”(508mm)	EUEB-0000-3HY	\$452.14
4-Circuit, 2+2	20”(508mm)	EUEB-0000-2HY	\$452.14
4-Circuit, 3+1	20”(508mm)	EUEB-0000-4HY	\$452.14

Single Circuit Base Feed – Receptacle Connection — 20 amp

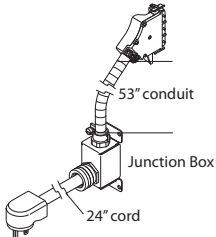

4TEB-20
Class TA



Features

- Includes one base feed, 24”(610mm) cord, junction box, 53”(1346mm) flexible conduit and 20 amp plug (NEMA 5-20P).
- For use with product equipped with 3-circuit or 4-circuit power components.
- Requires a 20 amp, 125 volt building receptacle (NEMA 5-20R) for plug-in (not included).
- Provides power to circuit #1 only.
- Attaches at either end of the Power Distribution Assembly (PDA).
- Standard in charcoal trim color only.

Specification Tips

- Not for use in Canada due to electrical code restrictions.
- **Not for use with isolated ground receptacles.**
- Not for use with power sources other than 120 volt 60 hertz.
- Junction box must be secured to furniture or architectural support.
- Do not mix 3-circuit with 4-circuit components. Do not mix 2+2 and 3+1 components. Components have unique polarity key and color coding (3-circuit=black, 2+2=blue and 3+1=green).
- Application may require approval of local authority having jurisdiction (AHJ); ensure compliance before placing orders and installation.

To Order, Specify:

- 1) Product number.
(No finish specification required.)

Description	Feed Length	Number	Price
3-Circuit (USA only)	24”(610mm)	4TEB-20	\$440.92
4-Circuit, 2+2 (USA only)		4TEB-20-2	440.92
4-Circuit, 3+1 (USA only)		4TEB-20-4	440.92

Benching Electrical Components and Covers

Upside

Single Circuit Base Feed – Receptacle Connection — 15 amp

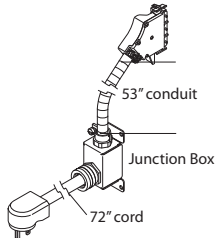

4TEB-154TEB-15
Class TA



Features

- Includes one base feed, 72”(1829mm) cord, junction box, 53”(1346mm) flexible conduit and 15 amp plug (NEMA 5-15P).
- For use with product equipped with 3-circuit or 4-circuit power components.
- Requires a 15 amp, 125 volt building receptacle (NEMA 5-15R) for plug-in (not included).
- Attaches at either end of the Power Distribution Assembly (PDA).
- Provides power to circuit #1 only.
- Standard in charcoal trim color only.

Specification Tips

- **Not for use in USA due to electrical code restrictions.**
- **Not for use with isolated ground receptacles.**
- Not for use with power sources other than 120 volt 60 hertz.
- Junction box must be secured to furniture or architectural support.
- Do not mix 3-circuit with 4-circuit components. Do not mix 2+2 and 3+1 components. Components have unique polarity key and color coding (3-circuit=black, 2+2=blue and 3+1=green).
- Application may require approval of local authority having jurisdiction (AHJ); ensure compliance before placing orders and installation.

To Order, Specify:

- 1) Product number.
(No finish specification required.)

Description	Feed Length	Number	Price
3-Circuit (Canada only)	72”(1829mm)	4TEB-15	\$440.92
4-Circuit, 2+2 (Canada only)		4TEB-15-2	440.92
4-Circuit, 3+1 (Canada only)		4TEB-15-4	440.92

Wall Feed Field Wired 1 Port

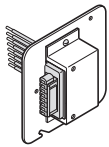

FBEW
Class YA



Features

- Includes 4.7”(119mm) junction box cover with one female modular power connector.
- For use with field supplied 4.7”(119mm) square junction box.
- Connector has integral latching system.
- UL listed Manufactured wiring system rated for 20 Amp 120V/208Y or 120/240V 60 Hz and for use in “other air handling spaces” per NEC Article 604.

Specification Tips

- For use with Internal Power Base AI Base Feed.
- Provides transition from building power to modular power distribution system. May be used with junction box in wall or column.
- Do not mix 3-circuit with 4-circuit components. Do not mix 2+2 and 3+1 components. Components have unique polarity key and color coding (3-circuit=rust and 4-circuit=black).

To Order, Specify:

- 1) Product number.
(No finish specification required.)

Description	Depth	Length/Width	Number	Price
3-Circuit	1.5”(38.1mm)	4.7”(119mm)	FBEW-0004-31	\$113.32
4-Circuit	1.5”(38.1mm)	4.7”(119mm)	FBEW-0004-41	\$113.32

Benching Electrical Components and Covers

Upside

Internal Power Base™ AI Base Feed

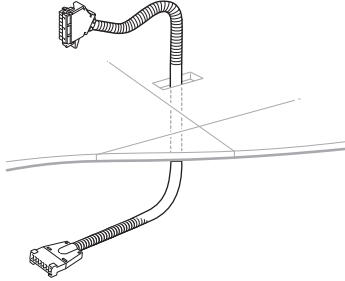

EUEJ-0064-3WF
EUEJ-0064-2WF
EUEJ-0064-4WF
Class YA



Features

- Includes connector assembly which consists of one Power Base connector head, galvanized 0.5”(13mm) flexible metal conduit, one Power Base AI connector head and a two port splitter.
- Conduit for 3-Circuit includes eight 12-gauge wires for up to three 20 amp circuits of power.
- Conduit for 4-Circuit includes six 12-gauge and two 10-gauge wires for up to four 20 amp circuits of power.
- For use with components equipped with power.
- Attaches at any receptacle site or right-hand jumper location and to a Wall Feed Field Wired 1 port.

Specification Tips

- **Not for use with power sources other than 120 volt 60 hertz.**
- A vertical base feed cover is a separately specified option.
- Exposed split tubing may be field supplied separately to cover exposed galvanized metal conduit.
- Do not mix 3-circuit with 4-circuit components. Do not mix 2+2 and 3+1 components. Components have unique polarity key and color coding (3-circuit = black; 2+2 = blue; 3+1 = green).

To Order, Specify:

- 1) Product number.
(No finish specification required.)

Description	Bench Feed Length	Number	Price
3-Circuit			
	64”(1626mm)	EUEJ-0064-3WF	\$ 276.75
	144”(3658mm)	EUEJ-0144-3WF	384.57
	300”(7620mm)	EUEJ-0300-3WF	918.29
4-Circuit, 2+2			
	64”(1626mm)	EUEJ-0064-2WF	\$303.70
	144”(3658mm)	EUEJ-0144-2WF	411.52
	300”(7620mm)	EUEJ-0300-2WF	945.24
4-Circuit, 3+1			
	64”(1626mm)	EUEJ-0064-4WF	\$303.70
	144”(3658mm)	EUEJ-0144-4WF	411.52
	300”(7620mm)	EUEJ-0300-4WF	945.24

Benching Electrical Components and Covers

Upside

Infeed Harness

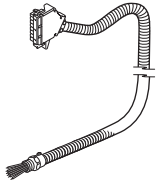

EUEH-0087-3
EUEH-0087-2
EUEH-0087-4
Class YA



Features

- Includes electrical harness in galvanized metal conduit.
- Conduit for 3-Circuit includes eight 12-gauge wires for up to three 20 amp circuits of power.
- Conduit for 4-Circuit includes six 12-gauge and two 10-gauge wires for up to four 20 amp circuits of power.
- For use with components equipped with power.
- Attaches at any receptacle site or right-hand jumper location.

Specification Tips

- **Not for use with power sources other than 120 volt 60 hertz.**
- Must be used with separately specified Top Feed Pole, Base Feed Cover, or Infill Panel Kit to route power to the Power Distribution Assembly (PDA).
- A bench base feed cover is a separately specified option.
- Exposed split tubing may be field supplied separately to cover exposed galvanized metal conduit.
- Do not mix 3-circuit with 4-circuit components. Do not mix 2+2 and 3+1 components. Components have unique polarity key and color coding (3-circuit = black; 2+2 = blue; 3+1 = green).

To Order, Specify:

- 1) Product number.
(No finish specification required.)

Description	Feed Length	Number	Price
3-Circuit			
	87"(2210mm)	EUEH-0087-3	\$ 276.75
	180"(4572mm)	EUEH-00F0-3	427.66
	300"(7620mm)	EUEH-00W0-3	720.59
4-Circuit, 2+2			
	87"(2210mm)	EUEH-0087-2	\$303.70
	180"(4572mm)	EUEH-00F0-2	454.61
	300"(7620mm)	EUEH-00W0-2	747.54
4-Circuit, 3+1			
	87"(2210mm)	EUEH-0087-4	\$303.70
	180"(4572mm)	EUEH-00F0-4	454.61
	300"(7620mm)	EUEH-00W0-4	747.54

Basefeed Cover

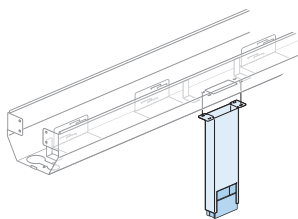
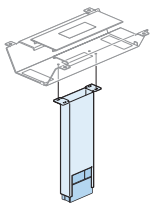

TJEA-BSFD
Class US

Feature

- Includes two-piece base feed cover and attachment hardware.

Specification Tips

- For use with Upside Benching only.
- Used to conceal power and data from floor or column to bottom of horizontal surface.
- Mounts under power and data channel or transition tray or center triangle tray and attaches to floor.
- Floor attachment hardware is field supplied.
- Application may require approval of local authority having jurisdiction (AHJ); ensure compliance before placing orders and installation.

To Order, Specify:

- 1) Product number.
- 2) Trim color.

Height	Number	Trim	
		A	B
12.5"(318mm)	TJEA-BSFD	\$155.00	\$175.00

Benching Electrical Components and Covers

Upside

Channel End Cover

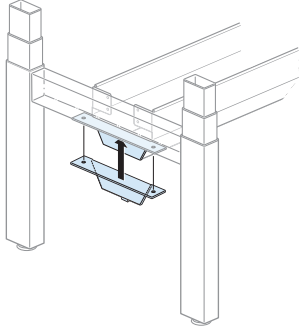

TJEA-ECVR
Class US

Feature

- Includes two covers.

Specification Tips

- Designed to cover opening at the end of a run.
- Two sets are needed for a three-sided 120° benching configuration.
- For use with Upside Benching Only.
- End Covers not needed when Privacy infill panels are used.
- Screw fasteners included in base assembly.

To Order, Specify:

- 1) Product number.
- 2) Trim color.

	Number	Trim A	B
	TJEA-ECVR	\$55.00	\$65.00

Privacy Infill Panel Kits

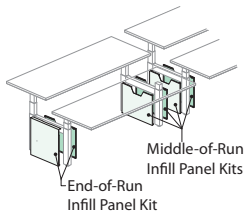

End-of-Run Privacy Infill Panel Kit
TJAC-PPEN

Middle-of-Run Privacy Infill Panel Kit
TJAC-PPMD

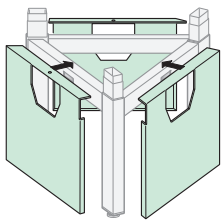

120° Center Triangle Privacy Infill Panel
TJAC-PPCT
Class US

Features

- End-of-Run Infill Kit includes:
 - One outer panel and one inner panel
 - Two infill panel brackets and clips
- Middle-of-Run Infill Kit includes:
 - Pair of inner panels
 - Two infill panel brackets and clips
- Center Triangle Infill Kit includes:
 - Three outer wrap panels
 - Three Foot Brackets

Specification Tips

- Infill Panels NOT FOR USE with single-sided benching units.
- Middle-of-Run Infill Panels should be used to accommodate transition trays when linking two-sided or three-sided 120° benching units together.
- Two-sided applications:
 - Specify End-of-Run Infill Panel at each unlinked benching end
 - Specify Middle-of-Run Infill Panels between in-line bases
- Three-sided applications:
 - Specify End-of-Run Infill Panel at each unlinked benching end
 - Specify Middle-of-Run Infill Panels between in-line bases
 - Specify 120° Center Triangle Infill Panel to close off center between connected bases
- End-of-Run Infill Panel will NOT accommodate an End-of-Run Top Feed Pole.
- Screw fasteners included in base assembly.

To Order, Specify:

- 1) Product number.
- 2) Trim color.

Description	Outer Height	Outer Width	Number	Trim A	B
End-of-Run Privacy Infill Panel Kit					
	18.4"(467mm)	19.7"(500mm)	TJAC-PPEN	\$279.00	\$294.00
Middle-of-Run Privacy Infill Panel Kit					
	15.3"(389mm)	19.7"(500mm)	TJAC-PPMD	\$279.00	\$294.00
120° Center Triangle Privacy Infill Panel Kit					
	18.4"(467mm)	21.6"(549mm)	TJAC-PPCT	\$ 419.00	\$434.00

Benching Electrical Components and Covers

Upside

Top Feed Pole, End-of-Run

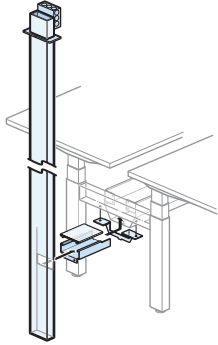

TJEA-TPFD-E
Class US

Features

- Includes one electrical box, ceiling bezel plate, pole, transition tray for end-of-run and hardware.
- For connection to the electrical source located in space above a drop ceiling.
- Removable cover on poles provides access to pathway.
- End-of-Run Top Feed mounts to the floor and attaches to benching crossbeam and ceiling.
- Top feed pole dimensions: 1.5"(38mm) x 4"(102mm).

Specification Tips

- **For use with Upside Benching only.**
- Not for use with Privacy Infill Kits or Belong Gallery End Panels.
- Power Infeed Harness is separately specified for Haworth modular power.
- Hardwire Applications: Conduit and wiring are field supplied.
- Floor attachment hardware is field supplied.
- Application may require approval of local authority having jurisdiction (AHJ); ensure compliance before placing orders and installation.

To Order, Specify:

- 1) Product number.
- 2) Trim color.

Description	Ceiling Height	Pole Length	Pole Pieces	Number	Trim	
					A	B
End-of-Run Top Feed Pole						
	10'(3048mm)	126"(3200mm)	2	TJEA-TPFD-ET	\$433.66	\$458.66
	12'(3658mm)	150"(3810mm)	2	TJEA-TPFD-EW	445.16	470.16

Top Feed Pole, Middle-of-Run

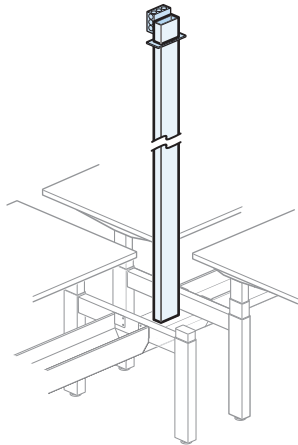

TJEA-TPFD-M
Class US

Features

- Includes one electrical box, ceiling bezel plate, pole and hardware.
- For connection to the electrical source located in space above a drop ceiling.
- For use with middle-of-run transition trays.
- Removable cover on poles provides access to pathway.
- Middle-of-run top feed mounts to ceiling and:
 - Transition tray between connecting benching units
 - Center triangle cover in 3-sided 120° applications
- Top feed pole dimensions: 1.5"(38mm) x 4"(102mm).

Specification Tips

- **For use with Upside Benching only.**
- Not for use with Privacy Infill Kits or Belong Gallery End Panels.
- Power Infeed Harness is separately specified for Haworth modular power.
- Hardwire Applications: Conduit and wiring are field supplied.
- See Product Details in Specification Guide for transition tray specification tips.
- Application may require approval of local authority having jurisdiction (AHJ); ensure compliance before placing orders and installation.

To Order, Specify:

- 1) Product number.
- 2) Trim color.

Description	Ceiling Height	Pole Length	Pole Pieces	Number	Trim	
					A	B
Middle-of-Run Top Feed Pole						
	10'(3048mm)	114"(2896mm)	1	TJEA-TPFD-MT	\$433.66	\$458.66
	12'(3658mm)	138"(3505mm)	2	TJEA-TPFD-MW	445.16	470.16

Benching Electrical Components and Covers

Upside

Single Power Distribution Assembly (PDA)

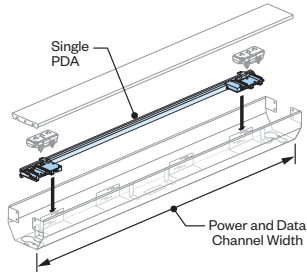

EUEP
Class YA

Features

- Includes one Power Distribution Assembly (PDA).
- Mounts inside the Power and Data Channel to route power within Upside benching.
- **Accommodates two triplex receptacles (ordered separately).**
- Worksurface width and PDA length shown in nominal dimensions.
- Field installed.

Specification Tips

- Used for power distribution in Upside single-sided, two-sided, and three-sided benching.
- PDA length must align with benching configuration and worksurface width.
- Separately specify:
 - Power Infeeds and covers
 - Power and Data Channel
 - Conduit Jumpers and Transition Trays
 - Triplex Receptacles
- Do not mix 3-circuit and 6-circuit with 4-circuit components. Do not mix 2+2 and 3+1 components. Components have unique polarity key and color coding (3-circuit = black, 6-circuit = ivory, 2+2 = blue and 3+1 = green).

To Order, Specify:

- 1) Product number.
(No finish specification required.)

Benching Configuration	Worksurface Width	PDA Length	Number	Price
3-Circuit				
Three-Sided 120°	46"(1168mm)	19"(483mm)	EUEP-0019-3S	\$ 70.00
	52"(1321mm)	25"(635mm)	EUEP-0025-3S	79.00
	58"(1473mm)	31"(787mm)	EUEP-0031-3S	88.00
Two-Sided/Single-Sided	46"(1168mm)	25"(635mm)	EUEP-0025-3S	\$ 79.00
	52"(1321mm)	31"(787mm)	EUEP-0031-3S	88.00
	58"(1473mm)	37"(940mm)	EUEP-0037-3S	97.00
	64"(1626mm)	43"(1092mm)	EUEP-0043-3S	106.00
	70"(1778mm)	49"(1245mm)	EUEP-0049-3S	115.00
4-Circuit, 2+2				
Three-Sided 120°	46"(1168mm)	19"(483mm)	EUEP-0019-2S	\$ 70.00
	52"(1321mm)	25"(635mm)	EUEP-0025-2S	79.00
	58"(1473mm)	31"(787mm)	EUEP-0031-2S	88.00
Two-Sided/Single-Sided	46"(1168mm)	25"(635mm)	EUEP-0025-2S	\$ 79.00
	52"(1321mm)	31"(787mm)	EUEP-0031-2S	88.00
	58"(1473mm)	37"(940mm)	EUEP-0037-2S	97.00
	64"(1626mm)	43"(1092mm)	EUEP-0043-2S	106.00
	70"(1778mm)	49"(1245mm)	EUEP-0049-2S	115.00
4-Circuit, 3+1				
Three-Sided 120°	46"(1168mm)	19"(483mm)	EUEP-0019-4S	\$ 70.00
	52"(1321mm)	25"(635mm)	EUEP-0025-4S	79.00
	58"(1473mm)	31"(787mm)	EUEP-0031-4S	88.00
Two-Sided/Single-Sided	46"(1168mm)	25"(635mm)	EUEP-0025-4S	\$ 79.00
	52"(1321mm)	31"(787mm)	EUEP-0031-4S	88.00
	58"(1473mm)	37"(940mm)	EUEP-0037-4S	97.00
	64"(1626mm)	43"(1092mm)	EUEP-0043-4S	106.00
	70"(1778mm)	49"(1245mm)	EUEP-0049-4S	115.00

Benching Electrical Components and Covers

Upside

Double Power Distribution Assembly (PDA) Kit

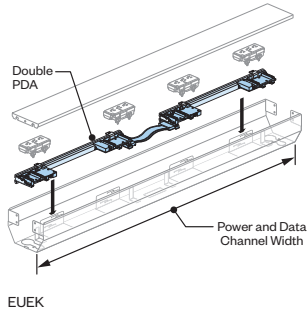

Features

- Includes two Power Distribution Assemblies (PDA) and one flexible power connector.
- Mounts inside the Power and Data Channel to route power within single-sided or two-sided Upside benching.
- Routes power through power & data channel for single-sided and two-sided applications ONLY.
- **Accommodates 4 Triplex Receptacles (ordered separately).**
- Worksurface width and PDA length shown in nominal dimensions.
- Field installed.

Specification Tips

- Not for use on three-sided 120° Benching units.
- PDA length must align with benching configuration and worksurface width.
- For use with rectangular worksurface widths 58" (1473mm) and wider.
- Separately specify:
 - Power Infeeds and covers
 - Power and Data Channel
 - Conduit Jumpers and Transition Trays
 - Triplex Receptacles
- Do not mix 3-circuit and 6-circuit with 4-circuit components. Do not mix 2+2 and 3+1 components. Components have unique polarity key and color coding (3-circuit = black, 6-circuit = ivory, 2+2 = blue and 3+1 = green).

To Order, Specify:

- 1) Product number.
(No finish specification required.)

Benching Configuration	Worksurface Width	PDA Length	Number	Price
3-Circuit				
Two-Sided/Single-Sided	58"(1473mm)	37"(940mm)	EUEK-0039-3D	\$157.99
	64"(1626mm)	43"(1092mm)	EUEK-0046-3D	168.98
	70"(1778mm)	49"(1245mm)	EUEK-0051-3D	176.83
4-Circuit, 2+2				
Two-Sided/Single-Sided	58"(1473mm)	37"(940mm)	EUEK-0039-2D	\$157.99
	64"(1626mm)	43"(1092mm)	EUEK-0046-2D	168.98
	70"(1778mm)	49"(1245mm)	EUEK-0051-2D	176.83
4-Circuit, 3+1				
Two-Sided/Single-Sided	58"(1473mm)	37"(940mm)	EUEK-0039-4D	\$157.99
	64"(1626mm)	43"(1092mm)	EUEK-0046-4D	168.98
	70"(1778mm)	49"(1245mm)	EUEK-0051-4D	176.83

Benching Electrical Components and Covers

Upside

Jumpers

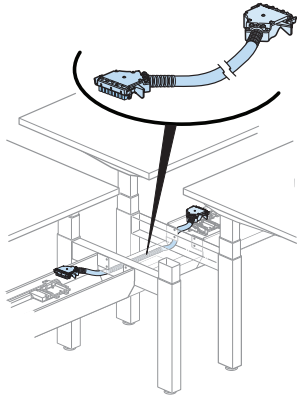

EUEJ
Class YA

Features

- For use with power components.
- Jumpers cannot be coupled together.
- Field installed.

Specification Tips

- Jumpers are used to connect power distribution assemblies between linked benching units.
- For single and two-sided applications:
 - Use 24"(610mm) Jumper with standard length transition tray in a single or two-sided benching application
 - Use 26"(660mm) Jumper with extended length transition tray in a single or two-sided benching application
- For three-sided 120° applications:
 - Use two 26"(660mm) jumpers to connect the Power Distribution assemblies in the middle of a 120° benching unit
 - Use 30"(762mm) Jumper to connect power between:
 - Single-sided to three-sided 120° benching unit
 - Two three-sided 120° benching units or
 - Two-sided to three-sided 120° benching unit
- Do not mix 3-circuit with 4-circuit components. Do not mix 2+2 and 3+1 components. Components have unique polarity key and color coding (3-circuit = black; 2+2 = blue; 3+1 = green).

To Order, Specify:

- 1) Product number.
(No finish specification required.)

Benching Configuration	Conduit Length	Number	Price
3-Circuit			
Two-Sided/Single-Sided	24"(610mm)	EUEJ-0024-3	\$ 166.35
	26"(660mm)	EUEJ-0026-3	169.95
Three-Sided 120°	26"(660mm)	EUEJ-0026-3	\$ 169.95
	30"(762mm)	EUEJ-0030-3	177.15
4-Circuit, 2+2			
Two-Sided/Single-Sided	24"(610mm)	EUEJ-0024-2	\$ 177.19
	26"(660mm)	EUEJ-0026-2	180.79
Three-Sided 120°	26"(660mm)	EUEJ-0026-2	\$ 180.79
	30"(762mm)	EUEJ-0030-2	187.99
4-Circuit, 3+1			
Two-Sided/Single-Sided	24"(610mm)	EUEJ-0024-4	\$ 177.19
	26"(660mm)	EUEJ-0026-4	180.79
Three-Sided 120°	26"(660mm)	EUEJ-0026-4	\$ 180.79
	30"(762mm)	EUEJ-0030-4	187.99

Benching Electrical Components and Covers

Upside

Transition Tray

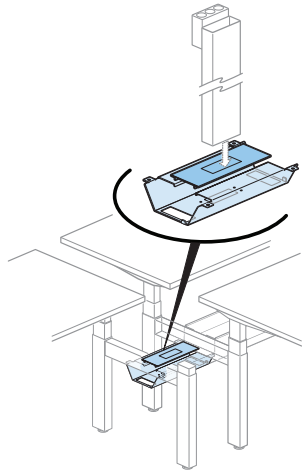

Class US

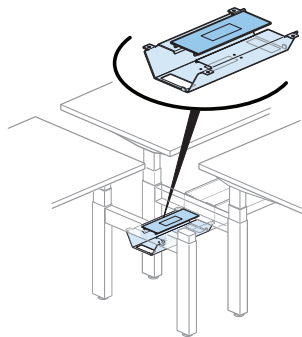

TJEA-HBTT-MN

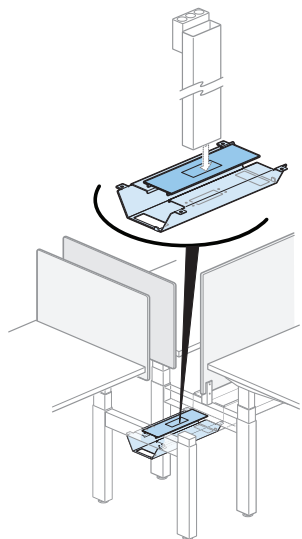

TJEA-HBTT-MS
Class US

Features

- Includes tray and cover.
- Perforated punchout for top and base feed access.
- Conceals and routes power and data cables between connecting benching units.
- Mounts to frame crossbeams between two in-line benching units.
- Standard length creates a 2"(51mm) clearance between in-line worksurfaces.
- Extended length creates a 4"(102mm) clearance between in-line worksurfaces.
- Removable cover provides access to power and data cable pathway.

Specification Tips

- Fits all Upside benching configurations (Single-sided, two-sided, and 3-sided).
- Standard length transition tray fits all Upside benching applications except when:
 - A center screen is combined with middle-of-run top feed pole
 - End screens are used between linked benching units to maintain 1"(25mm) pinch point clearance requirement
- Use Extended Length transition tray for exceptions above.
- Extended length transition tray must be used when applications include:
 - A center screen combined with middle-of-run top feed pole
 - Echo Full Wrap Screens and End screens between linked benching units to maintain 1"(25mm) pinch point clearance requirement
- Screw fasteners included in base assembly.
- Application may require approval of local authority having jurisdiction AHJ; ensure compliance before placing orders and installation.

To Order, Specify:

- 1) Product number.
- 2) Trim color.

Description	Length	Number	Trim	
			A	B
Standard Length	13.21"(336mm)	TJEA-HBTT-MN	\$161.00	\$176.77
Extended Length	15.21"(386mm)	TJEA-HBTT-MS	\$175.00	\$190.77

Benching Electrical Components and Covers

Upside

Triplex Receptacle – 15 Amp

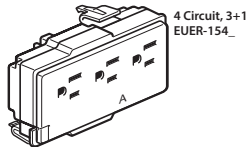
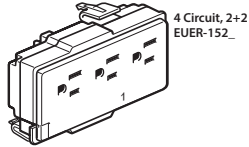
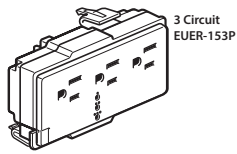
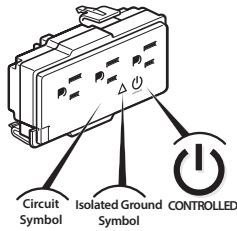

EUER-15
Class YA

Features

- Includes box of six receptacles, each receptacle has three 15 Amp outlets (NEMA 5-15R configuration).
- For use with benching equipped with power components.
- Receptacles are ground type specific.

Specification Tips

- Not for use with power sources other than 120 volt 60 hertz.
- Isolated ground receptacle not for use with single circuit base feed module.
- Triplexes for 3-Circuit are field programmable.
- Triplexes for 4-Circuit have fixed circuit access and are not field programmable. Specify appropriate number of receptacles for each circuit.
- Do not mix 3-circuit with 4-circuit components. Do not mix 2+2 and 3+1 components. Components have unique polarity key and color coding (3-circuit=black, 2+2=blue and 3+1=green).
- **Controlled receptacles are marked with a permanent symbol and the word CONTROLLED to comply with various energy code requirements including ASHRAE 90.1 and California Building Code Title 24 part 6.**
- **Circuit assignment and receptacle placement should be coordinated with a local electrician. Local electrician is responsible for circuit loading and code compliance.**
- **Consult with local authority having jurisdiction (AHJ) for requirements regarding controlled receptacles before placing orders and installation.**

Circuit Symbol	Circuit 1	Circuit 2	Circuit 3	Circuit 4
3 Circuit	0	00	000	NA
4 Circuit 2+2	1	2	3	4
4 Circuit 3+1	A	B	C	D

To Order, Specify:

- 1) Product number.

Description	Circuit Access	Receptacle Indicator	Ground Type	Receptacle without Controlled Symbol	Price	Receptacle with Controlled Symbol	Price
3-Circuit							
	Circuit 1-3	N/A	Common	EUER-153P-GSOS	\$ 177.24	EUER-153P-GCOS	\$ 181.68
	Circuit 1-3	N/A	Isolated	EUER-153P-ISOS	188.08	EUER-153P-ICOS	192.79
4-Circuit, 2+2							
	Circuit 1	1	Common	EUER-1521-GSOS	\$ 253.21	EUER-1521-GCOS	\$259.54
	Circuit 2	2		EUER-1522-GSOS	253.21	EUER-1522-GCOS	259.54
	Circuit 3	3		EUER-1523-GSOS	253.21	EUER-1523-GCOS	259.54
	Circuit 4	4		EUER-1524-GSOS	253.21	EUER-1524-GCOS	259.54
	Circuit 1	1	Isolated	EUER-1521-ISOS	\$264.05	EUER-1521-ICOS	\$270.66
	Circuit 2	2		EUER-1522-ISOS	264.05	EUER-1522-ICOS	270.66
	Circuit 3	3		EUER-1523-ISOS	264.05	EUER-1523-ICOS	270.66
	Circuit 4	4		EUER-1524-ISOS	264.05	EUER-1524-ICOS	270.66
4-Circuit, 3+1							
	Circuit 1	A	Common	EUER-1541-GSOS	\$ 253.21	EUER-1541-GCOS	\$259.54
	Circuit 2	B		EUER-1542-GSOS	253.21	EUER-1542-GCOS	259.54
	Circuit 3	C		EUER-1543-GSOS	253.21	EUER-1543-GCOS	259.54
	Circuit 4	D		EUER-1544-GSOS	253.21	EUER-1544-GCOS	259.54
	Circuit 1	A	Isolated	EUER-1541-ISOS	\$264.05	EUER-1541-ICOS	\$270.66
	Circuit 2	B		EUER-1542-ISOS	264.05	EUER-1542-ICOS	270.66
	Circuit 3	C		EUER-1543-ISOS	264.05	EUER-1543-ICOS	270.66
	Circuit 4	D		EUER-1544-ISOS	264.05	EUER-1544-ICOS	270.66

Benching Electrical Components and Covers

Upside

Triplex Receptacle – 20 Amp

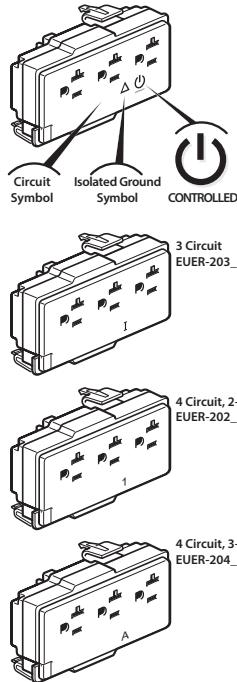

EUE-20
Class YA

Features

- Includes box of six receptacles, each receptacle has three 20 Amp outlets (NEMA 5-20R configuration).
- For use with benching equipped with power components.
- **Receptacles are circuit and ground type specific.**

Specification Tips

- Not for use with power sources other than 120 volt 60 hertz.
- Receptacles have fixed circuit access and are not field programmable. Specify appropriate number of receptacles for each circuit.
- Isolated ground receptacle not for use with single circuit base feed module.
- Do not mix 3-circuit with 4-circuit components. Do not mix 2+2 and 3+1 components. Components have unique polarity key and color coding (3-circuit=black, 2+2=blue and 3+1=green).
- **Controlled receptacles are marked with a permanent symbol and the word CONTROLLED to comply with various energy code requirements including ASHRAE 90.1 and California Building Code Title 24 part 6.**
- **Circuit assignment and receptacle placement should be coordinated with a local electrician. Local electrician is responsible for circuit loading and code compliance.**
- **Consult with local authority having jurisdiction (AHJ) for requirements regarding controlled receptacles before placing orders and installation.**

Circuit Symbol	Circuit 1	Circuit 2	Circuit 3	Circuit 4
3 Circuit	I	II	III	NA
4 Circuit 2+2	1	2	3	4
4 Circuit 3+1	A	B	C	D

To Order, Specify:

- 1) Product number.

Description	Circuit Access	Receptacle Indicator	Ground Type	Receptacle without Controlled Symbol	Price	Receptacle with Controlled Symbol	Price
3-Circuit							
	Circuit 1	1	Common	EUE-2031-GSOS	\$524.52	EUE-2031-GCOS	\$ 537.61
	Circuit 2	2		EUE-2032-GSOS	524.52	EUE-2032-GCOS	537.61
	Circuit 3	3		EUE-2033-GSOS	524.52	EUE-2033-GCOS	537.61
	Circuit 1	1	Isolated	EUE-2031-ISOS	\$535.35	EUE-2031-ICOS	\$548.72
	Circuit 2	2		EUE-2032-ISOS	535.35	EUE-2032-ICOS	548.72
	Circuit 3	3		EUE-2033-ISOS	535.35	EUE-2033-ICOS	548.72
4-Circuit, 2+2							
	Circuit 1	1	Common	EUE-2021-GSOS	\$524.52	EUE-2021-GCOS	\$ 537.61
	Circuit 2	2		EUE-2022-GSOS	524.52	EUE-2022-GCOS	537.61
	Circuit 3	3		EUE-2023-GSOS	524.52	EUE-2023-GCOS	537.61
	Circuit 4	4		EUE-2024-GSOS	524.52	EUE-2024-GCOS	537.61
	Circuit 1	1	Isolated	EUE-2021-ISOS	\$535.35	EUE-2021-ICOS	\$548.72
	Circuit 2	2		EUE-2022-ISOS	535.35	EUE-2022-ICOS	548.72
	Circuit 3	3		EUE-2023-ISOS	535.35	EUE-2023-ICOS	548.72
	Circuit 4	4		EUE-2024-ISOS	535.35	EUE-2024-ICOS	548.72
4-Circuit, 3+1							
	Circuit 1	A	Common	EUE-2041-GSOS	\$524.52	EUE-2041-GCOS	\$ 537.61
	Circuit 2	B		EUE-2042-GSOS	524.52	EUE-2042-GCOS	537.61
	Circuit 3	C		EUE-2043-GSOS	524.52	EUE-2043-GCOS	537.61
	Circuit 4	D		EUE-2044-GSOS	524.52	EUE-2044-GCOS	537.61
	Circuit 1	A	Isolated	EUE-2041-ISOS	\$535.35	EUE-2041-ICOS	\$548.72
	Circuit 2	B		EUE-2042-ISOS	535.35	EUE-2042-ICOS	548.72
	Circuit 3	C		EUE-2043-ISOS	535.35	EUE-2043-ICOS	548.72
	Circuit 4	D		EUE-2044-ISOS	535.35	EUE-2044-ICOS	548.72

Benching Electrical Components and Covers

Upside

Hardwire Kit

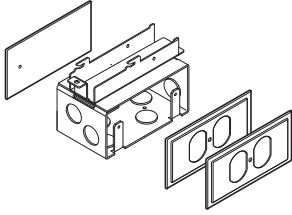

EUEE-UHDK
Class TA

Features

- Includes one electrical box with 0.5"(13mm) knockouts, two receptacle cover plates, one blank cover plate and mounting hardware.
- Attaches to PDA bracket.
- Field installed.

Specification Tip

- **Conduit, fittings, wiring and receptacles are field supplied.**

To Order, Specify:

- 1) Product number.
- 2) Trim color.

Number	Trim	
	A	B
EUEE-UHDK	\$205.90	\$205.90

HAWORTH

Height Adjustable Tables Resources

Surfaces Materials

Index

Warranty

Surface Materials — Upside Table

Finish/Color Legend

HPL

Grade A

Solid Color

H-34	Beige
H-AK	Chalk
H-8J	Charcoal
H-3J	Graphite
H-62	Gray Tone
H-WL	Linen
H-3P	Platinum
H-AA	Putty
H-3E	Smoke

Patterned

H-P1	Linen Casual
H-P2	Linen Classic
H-P3	Linen Crisp
H-P4	Linen Flax

Wood

H-B06	Brazilwood
H-E79	Colombian Walnut
H-AE	Maple
H-DYP	New Age Oak
H-E15	River Cherry
H-C09	Williamsburg Cherry

Grade B

Premium Wood Grain

H-C8	Blonde Modern Cherry
H-D1	Daintree
H-KP	Field Elm
H-KN	Grey Elm
H-KM	Landmark Wood
H-D2	Mocha Modern Cherry
H-KL	Neo Walnut
H-KR	Phantom Ecru
H-KS	Phantom Pearl
H-C9	Spiced Modern Cherry

Grade E

Premium

H-C1	Hay
H-C2	Drift
H-C3	Pecan
H-C4	Molasses
H-C5	Mineral
H-C6	Hatch
H-C7	Tanned

*Grade E laminates available on Rectangle Tops ONLY

Edgeband

Solid Color

HP-34	Beige
HP-AK	Chalk
HP-8J	Charcoal
HP-3J	Graphite
HP-62	Gray Tone
HP-WL	Linen
HP-3P	Platinum
HP-AA	Putty
HP-3E	Smoke

Patterned

H-P1	Linen Casual
H-P2	Linen Classic
H-P3	Linen Crisp
H-P4	Linen Flax

Wood Grain

HP-C8	Blonde Modern Cherry
HP-B06	Brazilwood
HP-E79	Colombian Walnut
HP-D1	Daintree
HP-KP	Field Elm
HP-KN	Grey Elm
HP-KM	Landmark Wood
HP-AE	Maple
HP-D2	Mocha Modern Cherry
HP-KL	Neo Walnut
HP-DYP	New Age Oak
HP-KR	Phantom Ecru
HP-KS	Phantom Pearl
HP-E15	River Cherry
HP-C9	Spiced Modern Cherry
HP-C09	Williamsburg Cherry

Ply-Edge

HP-PW	Ply-Edge
-------	----------

Premium

HP-C1	Hay
HP-C2	Drift
HP-C3	Pecan
HP-C4	Molasses
HP-C5	Mineral
HP-C6	Hatch
HP-C7	Tanned

Trim

Grade A

Smooth

*TR-R	Beige
*TR-AK	Chalk
TR-K	Charcoal
*TR-J	Graphite
*TR-G	Gray Tone
*TR-AA	Putty
*TR-E	Smoke
TR-PLS	Smooth Plaster

Textured

*TR-TG	Grout
*TR-TW	Plaster

Grade B

Solid Color

*TR-IR	Brownstone
*TR-IQ	Park
*TR-RR	Rusty Red
*TR-IM	Sable
TR-1J	Sky Blue

Smooth Metallic

*TR-MC	Metallic Champagne
TR-DM	Metallic Dark Bronze
TR-LE	Metallic Silver

NOTE: *Represents additional Upside+ paint finishes.

ALERT: These materials are current, however they are being considered for future obsolescence due to low volume.

HPL	
H-AM	Amber Cherry
H-AD	Medium Cherry

Edgeband	
HP-AM	Cherry
HP-AD	Medium Cherry

* Select textured and metallic colors will feature coordinating finishes on telescoping table base tube segment. See chart below:

Matrix for Telescoping Column Tube Finishes

Paint Type	Base Trim Color for Column/Foot		Telescoping Base Column Tubes Coordinating Finish	
	Smooth Metallic Paint	TR-DM	Dark Bronze Metallic	TR-1R
TR-MC		Metallic Champagne	TR-E	Smoke
Textured Paint	TR-TG	Grout	TR-AA	Putty
	TR-TW	Plaster	TR-PLS	Smooth Plaster
Smooth Paint (Non-Metallic)	Telescoping Base Column Tube Finish will match Base Trim Color specified for the Foot/Leg			
Metallic Silver (TR-LE)	Telescoping Base Column Tube Finish will match Base Trim Color specified for the Foot/Leg			

Forest Stewardship Council® (FSC®) Statement:

In our continuing support of sustainable forestry and responsible purchasing, Haworth North America is offering FSC certified wood products at no up-charge. By providing FSC certified material, Haworth is supporting our client's green building goals and demonstrating our collective commitment to source materials more sustainably. Haworth will provide to you the necessary FSC certified paperwork with your shipment. For more information, FAQs, and a complete FSC product list (including product exceptions), go to the Library and search FSC. Haworth FSC Trademark License #FSC-C002821

Surface Materials — Planes LT Table

Finish/Color Legend

HPL

Grade A

Solid Color

H-34	Beige
H-AK	Chalk
H-8J	Charcoal
H-3J	Graphite
H-62	Gray Tone
H-WL	Linen
H-3P	Platinum
H-AA	Putty
H-3E	Smoke

Wood

H-B06	Brazilwood
H-E79	Colombian Walnut
H-AE	Maple
H-DYP	New Age Oak
H-E15	River Cherry
H-C09	Williamsburg Cherry

Grade B

Premium Wood Grain

H-C8	Blonde Modern Cherry
H-D1	Daintree
H-KP	Field Elm
H-KN	Grey Elm
H-KM	Landmark Wood
H-D2	Mocha Modern Cherry
H-KL	Neo Walnut
H-KR	Phantom Ecu
H-KS	Phantom Pearl
H-C9	Spiced Modern Cherry

Grade E

Premium

H-C1	Hay
H-C2	Drift
H-C3	Pecan
H-C4	Molasses
H-C5	Mineral
H-C6	Hatch
H-C7	Tanned

*Grade E laminates available on Rectangle Tops ONLY

Edgeband

Solid Color

HP-34	Beige
HP-AK	Chalk
HP-8J	Charcoal
HP-3J	Graphite
HP-62	Gray Tone
HP-WL	Linen
HP-3P	Platinum
HP-AA	Putty
HP-3E	Smoke

Wood Grain

HP-C8	Blonde Modern Cherry
HP-B06	Brazilwood
HP-E79	Colombian Walnut
HP-D1	Daintree
HP-KP	Field Elm
HP-KN	Grey Elm
HP-KM	Landmark Wood
HP-AE	Maple
HP-D2	Mocha Modern Cherry
HP-KL	Neo Walnut
HP-DYP	New Age Oak
HP-KR	Phantom Ecu
HP-KS	Phantom Pearl
HP-E15	River Cherry
HP-C9	Spiced Modern Cherry
HP-C09	Williamsburg Cherry

Ply-Edge

HP-PW	Ply-Edge
-------	----------

Premium

HP-C1	Hay
HP-C2	Drift
HP-C3	Pecan
HP-C4	Molasses
HP-C5	Mineral
HP-C6	Hatch
HP-C7	Tanned

Trim

Grade A

Smooth

TR-R	Beige
TR-AK	Chalk
TR-K	Charcoal
TR-C1	Cocoa
TR-J	Graphite
TR-G	Gray Tone
TR-AA	Putty
TR-E	Smoke
TR-PLS	Smooth Plaster
TR-FM	Snow

Textured

TR-TG	Grout
TR-TF	Pitch
TR-TW	Plaster

Grade B

Smooth

TR-1C	Accent Blue
TR-1G	Blue Jay
TR-1R	Brownstone
TR-1N	Night
TR-1Q	Park
TR-RR	Rusty Red
TR-1M	Sable
TR-1J	Sky Blue

Smooth Metallic

TR-MC	Metallic Champagne
TR-DM	Metallic Dark Bronze
TR-LE	Metallic Silver
TR-MG	Metallic Gunmetal

Textured Metallic

TR-AR	Argent
TR-HE	Hellenic

Casters

TR-F	Black
TR-7	Fog
TR-LPL	Light Platinum

ALERT: These materials are current, however they are being considered for future obsolescence due to low volume.

HPL	
H-AM	Amber Cherry
H-AD	Medium Cherry

Edgeband	
HP-AM	Cherry
HP-AD	Medium Cherry

Trim	
TR-1E	Accent Orange
TR-1F	Accent Red
TR-CTS	Chartreuse
TR-1H	Terra
TR-1K	Wren

* Select textured and metallic colors will feature coordinating finishes on telescoping table base tube segment. See chart below:

Paint Type	Base Trim Color for Leg/Foot		Telescoping Base Tube Coordinating Finish	
	Textured Metallic Paint	Hellenic	TR-HE	Brownstone
Argent		TR-AR	Smoke	TR-E
Texture Paint	Grout	TR-TG	Platinum	TR-P
	Pitch	TR-TF	Black	TR-F
	Plaster	TR-TW	Smooth Plaster	TR-PLS
Smooth Paint (Non-Metallic)	Telescoping Base Tube Finish will match Base Trim Color specified for the Foot/Leg			
Smooth Metallic Paint	Telescoping Base Tube Finish will match Base Trim Color specified for the Foot/Leg			
	Metallic Champagne (TR-MC)			
	Metallic Silver (TR-LE)			
	Metallic Dark Bronze (TR-DM)			
	Metallic Gunmetal (TR-MG)			

Forest Stewardship Council® (FSC®) Statement:

In our continuing support of sustainable forestry and responsible purchasing, Haworth North America is offering FSC certified wood products at no up-charge. By providing FSC certified material, Haworth is supporting our client's green building goals and demonstrating our collective commitment to source materials more sustainably. Haworth will provide to you the necessary FSC certified paperwork with your shipment. For more information, FAQs, and a complete FSC product list (including product exceptions), go to the Library and search FSC. Haworth FSC Trademark License #FSC-C002821

Surface Materials — Planes Table

Finish/Color Legend

Wood

Grade A

Double Cut

2P-RL	Applegate
CQ-HKL	Auburn
CQ-HBF	Clove
WE-RD	Dune
WJ-RE	Ebony
2N-RL	Echo
W3-HR	Harbor
WE-RT	Melba
W4-PB	Pebble
CQ-WG	Walnut Grove

Grade B

Cherry

VC-CA1	Amber
VC-W23	American
VC-HKF	Burgundy
VC-W33	Caramel
VC-W30	Heritage
VC-W32	Pacific
VC-HKA	Toffee

Maple

VP-LM	Light
VP-N	Natural

Maple Quarter Cut

NM-N	Natural
------	---------

Oak

VJ-HKC	Urban
--------	-------

Rift Cut White Oak

NR-W35	Clear
NR-W15	Espresso
NR-W40	Mocha

Walnut

VR-CPK	Bourbon
VR-HKG	Colombian
VR-W15	Espresso
VR-W31	Retro

Walnut Quarter Cut

NW-W35	Clear
NW-W31	Retro

HPL

Grade A

Solid Color

H-34	Beige
H-AK	Chalk
H-8J	Charcoal
H-3J	Graphite
H-62	Gray Tone
H-WL	Linen
H-3P	Platinum
H-AA	Putty
H-3E	Smoke

Wood

H-B06	Brazilwood
H-E79	Colombian Walnut
H-AE	Maple
H-DYP	New Age Oak
H-E15	River Cherry
H-C09	Williamsburg Cherry

Grade B

Premium Wood Grain

H-C8	Blonde Modern Cherry
H-DI	Daintree
H-KP	Field Elm
H-KN	Grey Elm
H-KM	Landmark Wood
H-D2	Mocha Modern Cherry
H-KL	Neo Walnut
H-KR	Phantom Ecru
H-KS	Phantom Pearl
H-C9	Spiced Modern Cherry

Grade E

Premium

H-C1	Hay
H-C2	Drift
H-C3	Pecan
H-C4	Molasses
H-C5	Mineral
H-C6	Hatch
H-C7	Tanned

*Grade E laminates available on Rectangle Tops ONLY

Edgeband

Solid Color

HP-34	Beige
HP-AK	Chalk
HP-8J	Charcoal
HP-3J	Graphite
HP-62	Gray Tone
HP-WL	Linen
HP-3P	Platinum
HP-AA	Putty
HP-3E	Smoke

Wood Grain

HP-C8	Blonde Modern Cherry
HP-B06	Brazilwood
HP-E79	Colombian Walnut
HP-D1	Daintree
HP-KP	Field Elm
HP-KN	Grey Elm
HP-KM	Landmark Wood
HP-AE	Maple
HP-D2	Mocha Modern Cherry
HP-KL	Neo Walnut
HP-DYP	New Age Oak
HP-KR	Phantom Ecru
HP-KS	Phantom Pearl
HP-E15	River Cherry
HP-C9	Spiced Modern Cherry
HP-C09	Williamsburg Cherry

Ply-Edge

HP-PW	Ply-Edge
-------	----------

Premium

HP-C1	Hay
HP-C2	Drift
HP-C3	Pecan
HP-C4	Molasses
HP-C5	Mineral
HP-C6	Hatch
HP-C7	Tanned

Trim

Grade A

Smooth

TR-R	Beige
TR-AK	Chalk
TR-K	Charcoal
TR-C1	Cocoa
TR-J	Graphite
TR-G	Gray Tone
TR-AA	Putty
TR-E	Smoke
TR-PLS	Smooth Plaster
TR-FM	Snow

Textured

TR-TG	Grout
TR-TF	Pitch
TR-TW	Plaster

Grade B

Smooth

TR-IC	Accent Blue
TR-IG	Blue Jay
TR-IR	Brownstone
TR-IN	Night
TR-IQ	Park
TR-RR	Rusty Red
TR-IM	Sable
TR-IJ	Sky Blue

Smooth Metallic

TR-MC	Metallic Champagne
TR-DM	Dark Bronze Metallic
TR-LE	Metallic Silver
TR-MG	Metallic Gunmetal

Textured Metallic

TR-AR	Argent
TR-HE	Hellenic

Casters

TR-F	Black
TR-7	Fog
TR-LPL	Light Platinum

ALERT: These materials are current, however they are being considered for future obsolescence due to low volume.

Wood	
2R-RL	Butternut
NW-W15	Espresso
NP-W08	Golden
NP-W07	Light
NX-U	Medium
VR-W12	Naturally Walnut
WC-RW	Wenge

HPL	
H-AM	Amber Cherry
H-AD	Medium Cherry

Edgeband	
HP-AM	Cherry
HP-AD	Medium Cherry

Trim	
TR-1E	Accent Orange
TR-1F	Accent Red
TR-CTS	Chartreuse
TR-1H	Terra
TR-1K	Wren

* Select textured and metallic colors will feature coordinating finishes on telescoping table base tube segment. See chart below:

Matrix for Telescoping Base Tube Finishes

Paint Type	Base Trim Color for Leg/Foot		Telescoping Base Tube Coordinating Finish	
Smooth Metallic Paint	Metallic Champagne	TR-MC	Smoke	TR-E
	Metallic Silver	TR-LE	Smoke	TR-E
	Metallic Dark Bronze	TR-DM	Brownstone	TR-IR
Textured Metallic Paint	Metallic Gunmetal	TR-MG	Graphite	TR-J
	Hellenic	TR-HE	Brownstone	TR-IR
Textured	Argent	TR-AR	Smoke	TR-E
	Pitch	TR-TF	Black	TR-F
	Grout	TR-TG	Platinum	TR-P
	Plaster	TR-TW	Smooth Plaster	TR-PLS
Smooth Paint (Non-Metallic)	Telescoping Base Tube Finish will match Base Trim Color specified for the Foot/Leg			

Forest Stewardship Council® (FSC®) Statement:

In our continuing support of sustainable forestry and responsible purchasing, Haworth North America is offering FSC certified wood products at no up-charge. By providing FSC certified material, Haworth is supporting our client's green building goals and demonstrating our collective commitment to source materials more sustainably. Haworth will provide to you the necessary FSC certified paperwork with your shipment. For more information, FAQs, and a complete FSC product list (including product exceptions), go to the Library and search FSC. Haworth FSC Trademark License #FSC-C002821

Surface Materials — Planes Table

Fabrics/Color Legend

Vertical Fabrics

Grade A

- (6X) Chevron
- (35) Etch
- (L6) Highlands
- (C1) Striae
- (PY) Tailored
- (3A) Tellure

Grade B

- (33) Camp
- (L5) Classic
- (34) Fields
- (6) Hue
- (32) Peca
- (PV) Ritz
- (WS) Shimmer

Grade C

- (SW) Sisal

ALERT: These materials are current, however they are being considered for future obsolescence due to low volume.

Vertical Fabrics

- (PH) Birds Nest

* For most current finish and fabric availability please reference surfaces.haworth.com.

Haworth+

For information on the Haworth+ alliance program, including images and product availability, please refer to: [Haworth.com](https://www.haworth.com) > Surface Collection > Haworth+ Library

Customer's Own Material (COM)

For general Customer's Own Material (COM) information including processes and forms, please refer to: [Haworth.com](https://www.haworth.com) > Surface Collection > Resources > COM

For information on approved COM's, please refer to: [Haworth.com](https://www.haworth.com) > Surface Collection > COM Library

Index

Products are listed alphabetically in this index by alpha-numeric prefix/suffix codes.

Product Code	Product Description	
4TEB-15	Benching Electrical Components and Covers – Planes and Planes LT — Single Circuit Base Feed – Receptacle Connection — 15 amp	.116
4TEB-15	Benching Electrical Components and Covers – Upside — Single Circuit Base Feed – Receptacle Connection — 15 amp	.128
4TEB-20	Benching Electrical Components and Covers – Planes and Planes LT — Single Circuit Base Feed – Receptacle Connection — 20 amp	.115
4TEB-20	Benching Electrical Components and Covers – Upside — Single Circuit Base Feed – Receptacle Connection — 20 amp	.127
BSFD-S	Benching Electrical Components and Covers – Planes and Planes LT — Base Feed Cover	.118
EAET-C000-SC	Benching Electrical Components and Covers – Planes and Planes LT — Top Feed Pole, End-of-Run	.119
EAET-C00C-DC	Benching Electrical Components and Covers – Planes and Planes LT — Top Feed Pole, Middle-of-Run	.119
EUEA-DTBK	Upside Power & Data Channel for Benching – Data Port Bracket Kit	.113
EUEB-0000-2HY	Benching Electrical Components and Covers – Upside — Base Feed Module — Hardwire Connection for New York City	.127
EUEB-0000-3HY	Benching Electrical Components and Covers – Upside — Base Feed Module — Hardwire Connection for New York City	.127
EUEB-0000-4HY	Benching Electrical Components and Covers – Upside — Base Feed Module — Hardwire Connection for New York City	.127
EUEE-UHDK	Benching Electrical Components and Covers – Planes and Planes LT — Hardwire Kit	.126
EUEE-UHDK	Benching Electrical Components and Covers – Upside — Hardwire Kit	.139
EUEH-0087-2	Benching Electrical Components and Covers – Planes and Planes LT — Infeed Harness	.118
EUEH-0087-2	Benching Electrical Components and Covers – Upside — Infeed Harness	.130
EUEH-0087-3	Benching Electrical Components and Covers – Planes and Planes LT — Infeed Harness	.118
EUEH-0087-3	Benching Electrical Components and Covers – Upside — Infeed Harness	.130
EUEH-0087-4	Benching Electrical Components and Covers – Planes and Planes LT — Infeed Harness	.118
EUEH-0087-4	Benching Electrical Components and Covers – Upside — Infeed Harness	.130
EUEJ	Benching Electrical Components and Covers – Upside — Jumpers	.135
EUEJ-0018-3	Benching Electrical Components and Covers – Planes and Planes LT — Jumper	.121
EUEJ-0024-2	Benching Electrical Components and Covers – Planes and Planes LT — Jumper	.121
EUEJ-0024-4	Benching Electrical Components and Covers – Planes and Planes LT — Jumper	.121
EUEJ-0064-2WF	Benching Electrical Components and Covers – Planes and Planes LT — Internal Power Base™ AI Base Feed	.117
EUEJ-0064-2WF	Benching Electrical Components and Covers – Upside — Internal Power Base™ AI Base Feed	.129
EUEJ-0064-3WF	Benching Electrical Components and Covers – Planes and Planes LT — Internal Power Base™ AI Base Feed	.117
EUEJ-0064-3WF	Benching Electrical Components and Covers – Upside — Internal Power Base™ AI Base Feed	.129
EUEJ-0064-4WF	Benching Electrical Components and Covers – Planes and Planes LT — Internal Power Base™ AI Base Feed	.117
EUEJ-0064-4WF	Benching Electrical Components and Covers – Upside — Internal Power Base™ AI Base Feed	.129
EUEK	Benching Electrical Components and Covers – Upside — Double Power Distribution Assembly (PDA) Kit	.134
EUEK-2S	Benching Electrical Components and Covers – Planes and Planes LT — Utility Tray Power Retrofit Kit	.120
EUEK-3S	Benching Electrical Components and Covers – Planes and Planes LT — Utility Tray Power Retrofit Kit	.120
EUEK-4S	Benching Electrical Components and Covers – Planes and Planes LT — Utility Tray Power Retrofit Kit	.120
EUEP	Benching Electrical Components and Covers – Upside — Single Power Distribution Assembly (PDA)	.133
EUER-15	Benching Electrical Components and Covers – Planes and Planes LT — Triplex Receptacle – 15 Amp	.124
EUER-15	Benching Electrical Components and Covers – Upside — Triplex Receptacle – 15 Amp	.137
EUER-20	Benching Electrical Components and Covers – Planes and Planes LT — Triplex Receptacle – 20 Amp	.125
EUER-20	Benching Electrical Components and Covers – Upside — Triplex Receptacle – 20 Amp	.138
FBEW	Benching Electrical Components and Covers – Planes and Planes LT — Wall Feed Field Wired 1 Port	.116
FBEW	Benching Electrical Components and Covers – Upside — Wall Feed Field Wired 1 Port	.128
TA01-CLSN	Accessories – Planes and Planes LT Only — Collision Sensor	.114
TA01-CSTR	Accessories – Planes and Planes LT Only — Caster Kit	.114
TA01-HBTT-M	Benching Electrical Components and Covers – Planes and Planes LT — Transition Tray	.121
TA01-HBTT-MA	Benching Electrical Components and Covers – Planes and Planes LT — Transition Tray – Asymmetrical	.122
TA01-HBTT-MT	Benching Electrical Components and Covers – Planes and Planes LT — Transition Tray — For use with Middle-of-Run, Top Feed	.122

Index

Product Code	Product Description	
TAO1-HBTT-MTS	Benching Electrical Components and Covers – Planes and Planes LT — Transition Tray — For use with Center Screens and Middle-of-Run, Top Feed	.123
TACA	Planes Table — 90° Equal Corner — Straight – Electric Adjustment	.21
TACE-4064-NCDB	Planes Table — 90° Extended Corner — Wrap-Around – Incremental or Crank Adjustment	.28
TACE-4064-NCEB	Planes Table — 90° Extended Corner — Wrap-Around – Electric Adjustment	.31
TACE-6470-NCDE	Planes Table — 90° Extended Corner — Wrap-Around – Incremental or Crank Adjustment	.28
TACE-6470-NCEE	Planes Table — 90° Extended Corner — Wrap-Around – Electric Adjustment	.31
TACN	Planes Table — 90° Equal Corner — Notched – Electric Adjustment	.26
TACN-5858-NCEB	Planes Table — 90° Equal Corner — Notched – Electric Adjustment	.26
TACN-6464-NCEE	Planes Table — 90° Equal Corner — Notched – Electric Adjustment	.26
TACP-4070-NCEB	Planes Table — 90° Extended Corner — Notched – Electric Adjustment	.34
TACP-5270-NCEB	Planes Table — 90° Extended Corner — Notched – Electric Adjustment	.34
TACR	Planes Table — 90° Equal Corner — Wrap Around – Electric Adjustment	.23
TACR-5858-NCEB	Planes Table — 90° Equal Corner — Wrap Around – Electric Adjustment	.23
TACR-7070-NCEE	Planes Table — 90° Equal Corner — Wrap Around – Electric Adjustment	.23
TACZ	Planes Three-Sided Benching — 120° – Electric Adjustment	.88
TACZ-5858-NCEB	Planes Table — 120° Corner — Wrap-Around – Electric Adjustment	.37
TARA	Planes Table — Rectangular – Electric Adjustment	.17
TARA	Planes Table — Rectangular – Incremental or Crank Adjustment	.14
TARA-2458-NH	Planes Single-Sided Benching — Rectangular – Electric Adjustment	.85
TARA-2458-NH	Planes Two-Sided Benching — Rectangular – Electric Adjustment	.82
TJ01-CSTR	Accessories – Upside, Planes and Planes LT	.114
TJAC-PPCT	Benching Electrical Components and Covers – Upside — Privacy Infill Panel Kits — Upside	.131
TJAC-PPEN	Benching Electrical Components and Covers – Upside — Privacy Infill Panel Kits — Upside	.131
TJBA	Upside Base for Rectangular Table – Electric	.71
TJBA-2H	Upside Base for Two-Sided Benching – Electric	.108
TJBA-3C	Upside Base for Single-Sided Benching – Electric	.109
TJBA-3CXB-G	Upside Base for 90° or 120° Table – Electric Adjustment	.73
TJBA-3Z	Upside Base for Three-Sided 120° Benching – Electric	.110
TJEA-BSFD	Benching Electrical Components and Covers – Upside — Basefeed Cover	.130
TJEA-ECVR	Benching Electrical Components and Covers – Upside — Channel End Cover	.131
TJEA-HBTT-MN	Benching Electrical Components and Covers – Upside — Transition Tray	.136
TJEA-HBTT-MS	Benching Electrical Components and Covers – Upside — Transition Tray	.136
TJEA-PPMD	Benching Electrical Components and Covers – Upside — Privacy Infill Panel Kits — Upside	.131
TJEA-R	Upside Power and Data Channel for Benching – For use with Single-Sided or Two-Sided Applications	.113
TJEA-TPFD-E	Benching Electrical Components and Covers – Upside — Top Feed Pole, End-of-Run	.132
TJEA-TPFD-M	Benching Electrical Components and Covers – Upside — Top Feed Pole, Middle-of-Run	.132
TJEA-Z	Upside Power & Data Channel for Benching – For use with Three-sided 120° Applications	.113
TJRA	Upside Table — Rectangular – Electric Adjustment	.69
TLOE-4664-LJSNCP	Planes LT Table — 90° Extended Corner — Wrap-Around – Electric Adjustment	.58
TLOE-4670-NNNNCPB	Planes LT Base for 90° Extended Corner Table – Electric Adjustment	.65
TLOE-5270-NNNNCPB	Planes LT Base for 90° Extended Corner Table – Electric Adjustment	.65
TLOE-6470-LJSNCP	Planes LT Table — 90° Extended Corner — Wrap-Around – Electric Adjustment	.58
TLCN-5858-LJSNCP	Planes LT Table — 90° Equal Corner — Notched – Electric Adjustment	.52
TLCN-6464-LJSNCP	Planes LT Table — 90° Equal Corner — Notched – Electric Adjustment	.52
TLOP-4670-LJSNCP	Planes LT Table — 90° Extended Corner — Notched – Electric Adjustment	.56
TLOP-5270-LJSNCP	Planes LT Table — 90° Extended Corner — Notched – Electric Adjustment	.56
TLCR-5858-LJSNCP	Planes LT Table — 90° Equal Corner — Wrap-Around – Electric Adjustment	.54
TLCR-5858-NNNNCPB	Planes LT Base for 90° Equal Corner Table – Electric Adjustment	.63
TLCR-6464-LJSNCP	Planes LT Table — 90° Equal Corner — Wrap-Around – Electric Adjustment	.54
TLCR-6464-NNNNCPB	Planes LT Base for 90° Equal Corner Table – Electric Adjustment	.63
TLCZ-4646-LJSNHP	Planes LT Three-Sided Benching — 120° – Electric Adjustment	.98

Index

Product Code	Product Description	
TL CZ-4646-NNNNHPB	Planes LT Base for Three-Sided 120° Benching – Electric Adjustment	.104
TL CZ-5858-LJSNCPB	Planes LT Table — 120° Corner — Wrap-Around – Electric Adjustment	.60
TL CZ-5858-NNNNCPB	Planes LT Base for 120° Corner Table – Electric Adjustment	.67
TL RA-2358-LJSNCP	Planes LT Table — Rectangular – Electric Adjustment	.49
TL RA-2358-LJSNSP	Planes Single-Sided Benching — Rectangular – Electric Adjustment	.95
TL RA-2458-LJSNHE	Planes LT Two-Sided Benching — Rectangular – Electric Adjustment	.93
TL RA-2458-NNNNHE	Planes LT Base for Two-Sided Benching – Electric Adjustment	.100
TL RA-2946-NNNNCP	Planes LT Base for Rectangular Table – Electric Adjustment	.61
TL RA-2946-NNNNTP	Planes LT Base for Rectangular Table – Electric Adjustment	.61
TL RA-2958-NNNNSP	Planes LT Base for Single-Sided Benching – Electric Adjustment	.102
TM CE-4064-NCEB	Planes Base for 90° Extended Corner Table – Electric Adjustment	.45
TM CE-6470-NCEE	Planes Base for 90° Extended Corner Table – Electric Adjustment	.45
TM CR-5858-NCEB	Planes Base for 90° Equal Corner Table – Electric Adjustment	.43
TM CR-6464-NCEE	Planes Base for 90° Equal Corner Table – Electric Adjustment	.43
TM CZ-5858-NCEB	Planes Base for 120° Corner Table – Electric Adjustment	.47
TM RA	Planes Base for Rectangular Table – Electric Adjustment	.41
TM RA	Planes Base for Rectangular Table – Incremental or Crank Adjustment	.39
TM RA-2458-NH	Planes Base for Two-Sided Benching – Electric Adjustment	.90
TR CE-4652	Upside Worksurface for Table — 90° Extended Corner – Wrap-Around	.76
TR CE-4652	Upside Worksurface for Table — 90° Transitional Extended Corner – Wrap-Around	.78
TR CE-4652	Upside Worksurface for Table — 90° Transitional Extended Corner – Wrap-Around	.78
TR CE-6470	Upside Worksurface for Table — 90° Extended Corner – Wrap-Around	.76
TR CR-5252	Upside Worksurface for Table — 90° Equal Corner – Wrap-Around	.75
TR CR-7070	Upside Worksurface for Table — 90° Equal Corner – Wrap-Around	.75
TR CZ	Upside Worksurface for Benching — 120° Corner — Wrap-Around	.112
TR CZ-4646	Upside Worksurface 120° Corner – Wrap-Around	.80
TR RA	Upside Worksurface for Benching — Rectangular	.111
TR RA	Upside Worksurface for Table — Rectangular	.74
TV BC	Benching Electrical Components and Covers – Planes and Planes LT — Power/Data Cover	.120
VZ EB-0000-Y	Benching Electrical Components and Covers – Planes and Planes LT — Base Feed Module — Concealed Hardwire Connection for New York City	.115

Product Compatibility and Limited Warranty Policy

Great Expectations

You have them as a Haworth customer and so do we. And because we value our customers, we cover our products with the Haworth North America Product Compatibility and Limited Warranty Policy.

Our Commitment To Product Compatibility – Integrated Product Platforms

As a market leader in the design and manufacture of workspaces that adapt to change, we strive to maintain product compatibility within our various generations of integrated product platforms. This benefits the customer who desires to update or modify their work environment. It also benefits the customer needing to replace a product due to damage or other reasons but which is no longer manufactured or is otherwise unavailable, such as a fabric or finish that is discontinued because of changing market preferences. In both circumstances, we often can provide products with comparable function and performance.

Our Commitment To Product Quality – The Haworth North America Limited Warranty

To ensure customer satisfaction and peace of mind, we stand behind our products with the Haworth North America Limited Warranty. To review the current version of the limited warranty including its terms and conditions, please go to:

www.haworth.com/warranty or contact OneTouch@Haworth.com or 1 877 429 6784.

Warranty Requests or Questions

For questions or service requests pertaining to the Haworth Limited Warranty, please contact your Haworth dealer.

If you are unsure who your dealer is, please contact **OneTouch@Haworth.com or 1 877 429 6784.**

Terms of Sale

The Terms of Sale apply to all products in the North America Price Lists. To review the current version of the North American Terms of Sale, please go to:

www.haworth.com/terms-of-sale or contact OneTouch@Haworth.com or 1 877 429 6784.

HAWORTH

HAWORTH® is a registered trademark of Haworth, Inc.

© Haworth, Inc. All rights reserved. 2025 2.25

haworth.com | 800 344 2600