

Haworth Pricing Surcharge

A non-discountable 1.75% of list price surcharge will be applied to all orders placed after April 07, 2025

Compose

North America Price List – February 2025

Includes Compose, Compose Connections, Compose Beam and Compose Gallery Panels



Electronic Update Page – Compose

- The table below lists all of the updates and addendums added to this price list since the original version was created.
- All **Update** pages will replace the existing pages within the document.
- All **New** pages will be placed at the back of the document.

Link	Date	Pages	Description
Click Here	April 2025	All Price List Pages	Update – Pricing Surcharge – effective April 7, 2025 all future orders will have a non-discountable 1.75% of list price surcharge added.
Click Here	April 2025	1A-5A	New – New pages added for Tile-to-Floor Base Raceway Technology Access and End of Run Top Feed Module.
Click Here	May 2025	96	Update – Tile to Floor option for End-of-Run Trim was discontinued and removed.



This Haworth North American price book contains US list prices.
Canadian customers can convert the US list price into their Canadian equivalent by going to www.Haworth.com/Canada to find the current Canadian multipliers. These multiplier factors allow you to convert the US list price into a Canadian list price.

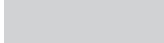

This page intentionally left blank.

Compose Price List

Includes pricing, catalog numbers, finish codes/availability, specification requirements, line art, dimensions, and specification tips for Compose.

Structures

High Acoustical Inserts

Tiles

Panel Accessories

Electrical Components

Gallery Panels

Gallery Panel Accessories

Adaptable Worksurfaces

Worksurface Supports

Worksurface Accessories

Upper Storage

Adaptable Upper Storage

Wall Mount Components

Lighting

Table of Contents

Price List

Statement of Line	9	Full Panel — End-of-Run Trim — Work Rail	91
Structures		Full Panel — End-of-Run Steel Trim Bottom Bracket Clip	91
Power Location Overview - Full Panel Frame	27	Full Panel — Trim and Corner Connectors — Steel, Aluminum, Wood	92
Full Panel Frames	28	Full Panel — Trim and Corner Connectors — Work Rail	94
Glass Panels — Glass Panel	31	Full Panel — Trim and Corner Connectors — 3- & 4-Way Intersection — Top Cap	95
Full Panel Frame Foot	33	Connections — End-of-Run Trim	96
Connections Frame	34	Connections — Raceway End-of-Run Cover	96
Connections Frame Leg — In-Line and End-of-Run Condition	35	Connections — Trim and Corner Connectors	97
Connections Frame Leg — 2-, 3-, 4-Way Intersection	36	Beam — End-of-Run Trim	98
Beam Frame	37	Beam — Trim and Corner Connectors	99
Beam Frame Leg — Straight Leg with Foot — In-Line and End-of-Run Condition	38	Beam — Trim and Corner Connectors — No Top Cap	100
Beam Frame Leg — Straight Leg — 2-, 3-, 4-Way Intersection	38	Beam — Steel Trim Top Cap Aligner Clip	100
Beam Frame Leg — A Leg — In-Line and End-of-Run Condition	39	Variable Height Trim — Proud	101
High Acoustical Inserts	40	Variable Height Trim 3-Way & 4-Way — Flush 90°	102
Tiles - Full Panel, Connections and Stack Frame		Variable Height Trim (Flush) — 120°	102
No Technology Access	42	Corner Block Assembly — 90°	103
Right-Hand Port	42	Corner Block Assembly — 120°	103
Left and Right-Hand Port	42	3-Way Intersection — Spanning Tile Corner Blocks	103
No Technology Access	42	Aligner/Light Block	104
Fabric	43	Half Aligner/Light Block	104
Laminate	46	Vertical Light Block (Between Panel)	105
Steel	51	Friction Pad	106
Wood	54	Seismic Anchoring Kit	106
Matched Natural Wood Tile Set	59	Anchoring Bracket	106
Markerboard	61	T-Mount	107
Slat	62	Panel Frame Wall Mount	108
Open Frame	63	Glass Panel Wall Mount	108
Glass	64	Tie Bracket Kit - Glass Stack	108
Hardware Kit — Glass Tile/Open Frame Tile (10 bolts/nuts)	64	Glass to Glass Connectors — In-Line	109
Compose Echo Integrated		Glass to Glass Connectors — End-of-Run/Intersection	109
Slotted Accessory Tile	65	Glass to Glass Connectors — Variable Height	109
Compose Echo Accessory		Electrical Components	
Ledge	66	Base Feed Module — Hardwire Connection	110
External Mount Tiles — Full Panel and Connections		Single Circuit Base Feed Module — Receptacle Connection with Power Cord	110
Slat, 16" External Mount	67	Base Feed Module — Concealed Hardwire Connection	111
Tackboard, External Mount	67	Base Feed Module — Hardwire Connection	112
Markerboard, External Mount	68	Base Feed Module — Hardwire Connection — Connections and Beam	112
Tiles - Beam		Internal Power Base AI Base Feed	113
No Technology Access	69	Raised Floor Infeed Base Feed Module	114
Right-Hand Port	69	Wall Feed Field Wired 1 Port	114
Left-Hand Port	69	Top Feed Module	115
Left and Right-Hand Port	69	End-of-Run Top Feed Module — Connections only	117
No Technology Access	69	End-of-Run Top Feed Module — Beam only	118
Fabric	70	Full Panel Infeed Harness	119
Laminate	71	Infeed Harness	119
Steel	72	Power Retrofit Kit — 42"(1067mm)H Beltline, 58"(1473mm)H Standing Height and Connections	120
Wood	73	Power Retrofit Kit — Beltline, 50"(1270mm)H or Greater, Below WS and Standing Height	121
Panel Accessories		Power Retrofit Kit — Standing Height	122
Stack Frame	74	Power Retrofit Kit — Raceway	123
Glass Stack	75	Raceway Covers	124
Frameless Glass and Rail Kit	76	Vertical Power Connector	125
Frameless Glass Bottom Rail	81	Flexible Power Connector — Raceway	125
Bottom Rail End Cap	83	Flexible Power Connector — Work-height	126
Frameless Glass — End-of-Run Clip for use with Aluminum Bottom Rail	83	Flexible Power Connector — Corner Span, Work-height	126
Glass Top Trim Clip Kit	83	Flexible Power Connector — Straight Span, Raceway/Work-height	127
Glass Topper	84	Extended Power Connector	127
Glass Topper — Bottom Rail Kit	85	Power Connector — Below WS	128
Alignment Clip Kit	85	Triplex Receptacle — 15 Amp	129
Sliding Door	86	Triplex Receptacle — 20 Amp	130
Filler Post — Sliding Door	86	Information Plate Communication Port Kits	131
Top Trim — Steel, Aluminum, Wood	87	Receptacle Blank Cover	131
Top Trim — Work Rail	88	Power and Communication Bezel — Full Panel and Connections	131
Top Trim — Off Modular Top Trim	89	Data Blank Cover — Full Panel and Connections	132
Top Trim — Work Rail Top Trim Cover	90	Power and Communication Bezel — Beam	132
Top Trim — Work Rail Top Trim Off-Modular Bracket	90		
Full Panel — End-of-Run Trim — Steel/Aluminum/Wood	91		

Table of Contents

Communication Data Bracket — Beam	132	Adaptable Worksurfaces — Rectangular	General Specifications	212
Data Blank Cover — Beam	133		Rectangular	213
Frame Rail Grommet	133		Rectangular Transition	215
Tile Grommet Kit	133		Swell/Inverse Swell—Swell/Inverse Swell	216
Frame Mounted Power Tap Bracket — Concealed	134		Wedge/Sharp Wedge—Wedge/Sharp Wedge	217
Frame Mounted Data Plate Bracket — Concealed	134		Rectangular Radius End	220
Adaptor Plate, Single Gang	134	Adaptable Worksurfaces — Corner	General Specifications	221
Cable Management Bracket	135		Bent	222
Compose Task Light Cord Manager	135		120° Rectangular Radius and Square End — 120° Rectangular	
Compose Connections Cable Chain	135		Radius End/120° Rectangular Square End	223
Power Break Marker	135		Wrap Around Corner — 120°	224
Power Distribution for Hardwire Applications	136		Merger Corner — 90°	225
Electrical Components			Straight Front Corner — 90°	226
Hardwire — Base Feed Hardwire Plate	137		Wrap-Around Corner — 90° — Wrap-Around/Wrap-Around	
Hardwire — Top Feed Module, Hardwired (Pole Only)	137		Transitional	227
Hardwire — End-of-Run Top Feed Module, Hardwired (Pole Only) —			Wrap-Around Extended Corner — 90° — Wrap-Around	
Connections and Below WS Power	138		Extended/Wrap-Around Extended Transitional	228
Hardwire — End-of-Run Top Feed Module, Hardwired (Pole Only) —			Notched Corner — 90° — Notched/Notched Transitional	232
Beam Only	138		Notched Extended Corner — 90°	233
Hardwire — Raceway Retrofit Kits	139		Angled Corner — 90° — Angled/Angled Transitional	235
Hardwire — Raceway Covers	140	Adaptable Worksurfaces — Convergent	General Specifications	236
Hardwire — Hardwire Power Kit — Single Sided for 26”(660mm)H			Rectangular	237
Below WS, Connections and 42”(1067mm)H Panels at the Beltline	141		D-Shape Convergent	238
Hardwire — Hardwire Power Kit — Double Sided for 26”(660mm)H			D-Shape Ender Convergent	239
Below WS, Connections and 42”(1067mm)H Panels at the Beltline	141		D-Shape Convergent Wrap-Around	240
Hardwire — Hardwire Power Kit for Beltline, 50”H or Greater,			Radius Convergent — Radius Rectangular/Radius Wedge	242
Below WS and Standing Height	142		Radius Half Convergent — Rectangular/Wedge	243
Hardwire — Hardwire Power Kit — Single Sided for Beam	143		Wedge Half Convergent Plus	244
Hardwire — Hardwire Power Kit — Double Sided for Beam	143	Adaptable Worksurfaces — Conference End	Conference End/Key Conference End	245
Hardwire — Receptacle Plate, Hardwired	144		Adaptable Worksurfaces — 120° Link	246
Gallery Panel			Adaptable Worksurfaces — Triangular Key	247
Gallery Panel to Full Panel — Catalog Logic	145		Adaptable Worksurfaces — Rectangular Key	248
Gallery Panel to Beam — Catalog Logic	146		Adaptable Worksurfaces	
Gallery Panel to Gallery Panel — Catalog Logic	147		Countertop	249
Gallery Panel to Compose Panel End-of-Run			Adaptable Worksurfaces — Adjustable Split Top	
L/R (Left or Right Mount)	148		Rectangular	250
W/E (Half Left or Half Right Mount)	151		Corner — 90°	250
C (Center Mount)	156	Worksurface Support		
Gallery Panel to Compose Panel Intermediate			Worksurface Support Panels	251
T (Two-Sided Left/Right)	159		Worksurface Support Panels — Anti Dislodgement Bracket	
H (Two-Sided Half Left/Right)	162		for use with Worksurface Support Panels	252
X (Center - Two Sided Mount)	165		Standard Cantilever Bracket	253
Gallery Panel to Compose Beam End-of-Run			Standard Mini Cantilever Bracket	253
L/R (Left or Right Mount)	168		Connections Cantilever Bracket	253
W/E (Half Left or Half Right Mount)	171		Beam Cantilever Bracket	254
C (Center Mount)	176		Gallery Panel Cantilever Bracket	254
Gallery Panel to Compose Beam Intermediate			Standard Link Cantilever Bracket	255
T (Two Sided Left/Right)	179		Side/Corner Bracket — Full Panel	255
H (Two Sided Half Left/Right)	182		Side/Corner Bracket for use with Knife Edge — Full Panel	255
X (Center - Two-Sided Mount)	185		Side/Corner Bracket — 26”(660mm)H, Connections or Beam	256
Gallery Panel to Gallery Panel Face Attachment			Flush Mount Plate	256
L/R (Left or Right Mount)	188		Work Rail Top Trim Off-Modular Bracket	256
C (Center Mount)	191		Gallery Panel Attachment Bracket	257
Gallery Panel to Gallery Panel End Attachment			Convergent Bracket	257
I (90° Face or Post Connection)	194		Countertop Bracket Kit	258
S (Straight In-Line Add-On)	197		Gallery Panel Countertop/OSU Bracket Kit	258
Gallery Panel Accessories			Column Leg	259
Brackets — Tie Plate	200		Straight Leg Basic — Height Adjustable	259
Glass Topper — Gallery Panel Mounting	201		Single Support Leg	259
Topper Holder Kit	203		Support Post— Height Adjustable	260
Insert Glass — Gallery Panel Glass Ready Option	204		Support Column	260
Compose Echo Tackboard	206		End Leg Kit	261
Compose Tile Hardware Kit	207		Return Leg Kit	261
Gallery Panel Hanging Brackets	208		P-Leg	262
Trim Post — Variable Height — Intermediate Intersection	209		Double Support Leg	262
Trim Post — 3-Way or 4-Way — Intermediate Full Height	210			

Table of Contents

Worksurface Accessories

Worksurface Reinforcement Channel	263
Worksurface Reinforcement Bar	263
Stanchions	264

Panel-to-Storage Bracket

A Series / Be_Hold	265
Compose Storage	265
X Series – Attached Pedestal	265
X and V Series Attached 2H Storage	265
Beside Pantry / X and V Series Freestanding	265

Upper Storage

Storage Box	267
-------------	-----

Storage Box Accessories

Ganging Flat Bracket for Storage Box	274
--------------------------------------	-----

Upper Storage — Adaptable

Overhead Storage Unit — Standard Mount	275
Overhead Storage Unit — Up Mount	280
Open Shelf Standard Mount	285
Shelf Divider	285
Overhead Storage Unit / Shelf Gang Clip	285

Wall Mount Components

Overhead Storage Unit — Wall Mount	286
Wall Track	291
Back for Wall Mounted Overhead Storage Unit	291
Worksurface and Gallery Panel Wall Mount Bracket	291
Tackboard, Wall Mount	292
Markerboard, Wall Mount	292

Lighting

Task — Reed Premiere™ Stand-Alone LED Task Light	293
Task — Reed Premier™ Starter LED Task Light	293
Task — Reed Premiere™ Add-On LED Task Light — For Use with Reed Premier Starter LED Task Lights	294
Task — Reed Premier™ Add-On Occupancy Sensor	294
Task — Adjustable LED Task Light – Stand-Alone	295
Task — Adaptable LED Task Light – Starter Kit	295
Task — Adaptable LED Task Light – Add-On Kit	296

Resources

Fabrics and Finishes

Finish/Color Legend	298
---------------------	-----

COM Yardage Requirements

Compose Tile Fabric Usage	300
---------------------------	-----

Index	302
-------	-----

Lifetime Product Warranty	Inside Back Cover
---------------------------	-------------------

Statement of Line

Structures

Pages 28-39

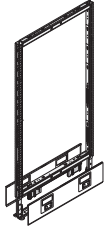

• Base Raceway Power
Full Panel Frame

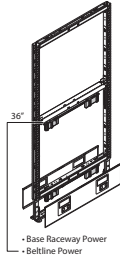

• Base Raceway Power
• Beltline Power
• Below Worksurface Power
Full Panel Frame

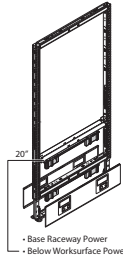

• Base Raceway Power
• Below Worksurface Power
Full Panel Frame

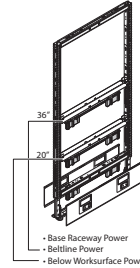

• Base Raceway Power
• Beltline Power
• Below Worksurface Power
Full Panel Frame

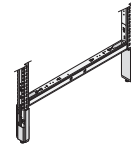

Open Base

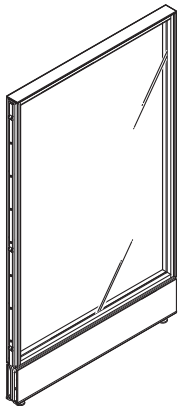

Glass Panel with Raceway Cover

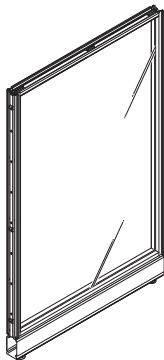

Glass Panel without Raceway Cover

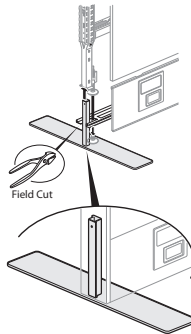

Full Panel Frame Foot

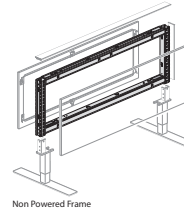

Non Powered Frame

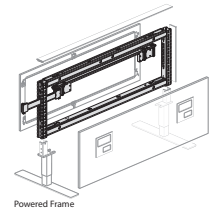

Powered Frame

Connections Frame

Connections Frame

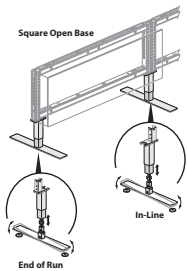

Connections Frame Leg — In-Line and End-of-Run Condition

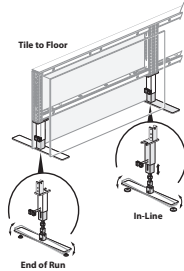

Connections Frame Leg — In-Line and End-of-Run Condition

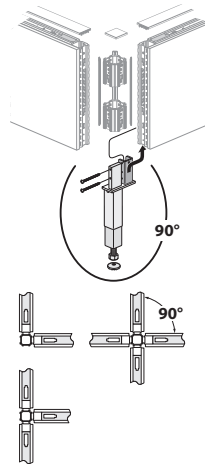

Connections Frame Leg — 2-, 3-, 4-Way Intersection

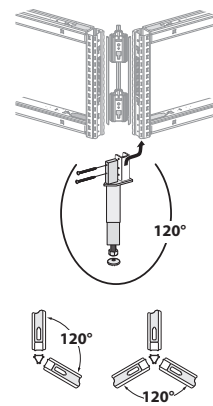

Connections Frame Leg — 2-, 3-, 4-Way Intersection

Statement of Line

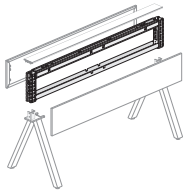

Beam Frame — Non Powered Frame

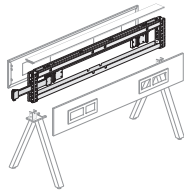

Beam Frame — Powered Frame

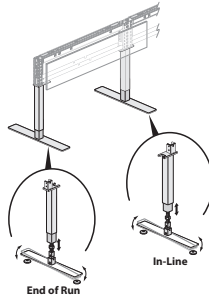

Beam Frame Leg — Straight Leg with Foot — In-Line and End-of-Run Condition

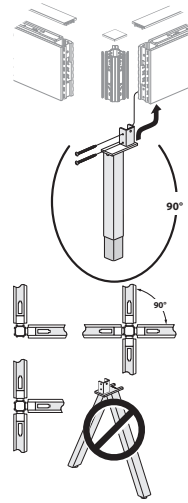

Beam Frame Leg — Straight Leg — 2-, 3-, 4-Way Intersection

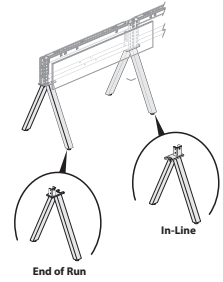

Beam Frame Leg — A Leg — In-Line and End-of-Run Condition

High Acoustical Inserts

Page 40

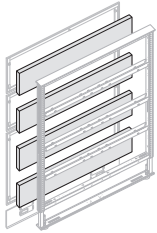

High Acoustical Insert

Tiles – Full Panel, Connections and Stack Frame

Pages 42-64



Tiles – Full Panel, Connections and Stack Frame

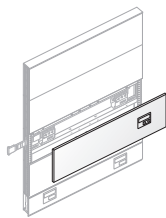

Tiles – Full Panel, Connections and Stack Frame

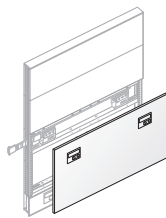

Tiles – Full Panel, Connections and Stack Frame

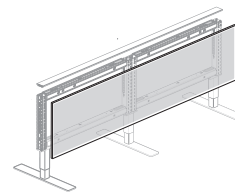

Tiles – Full Panel, Connections and Stack Frame

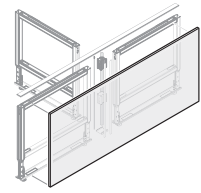

Tiles – Full Panel, Connections and Stack Frame

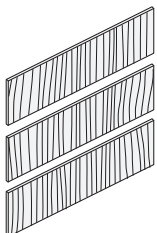

Matched Natural Wood Tile Set

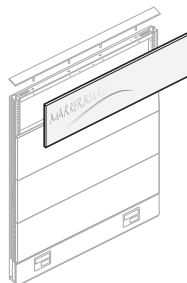

Markerboard

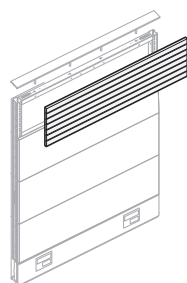

Slat

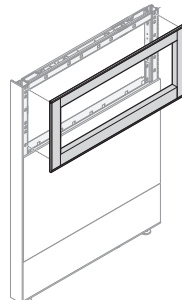

Open Frame

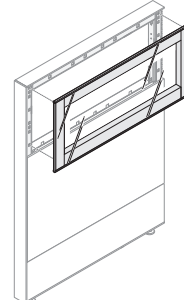

Glass

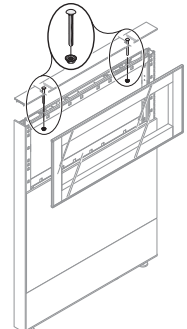

Hardware Kit — Glass Tile/Open Frame Tile (10 bolts/nuts)

Statement of Line

Compose Echo Integrated/Accessory Pages 65-66

External Mount Tiles — Full Panel and Connections Pages 67-68

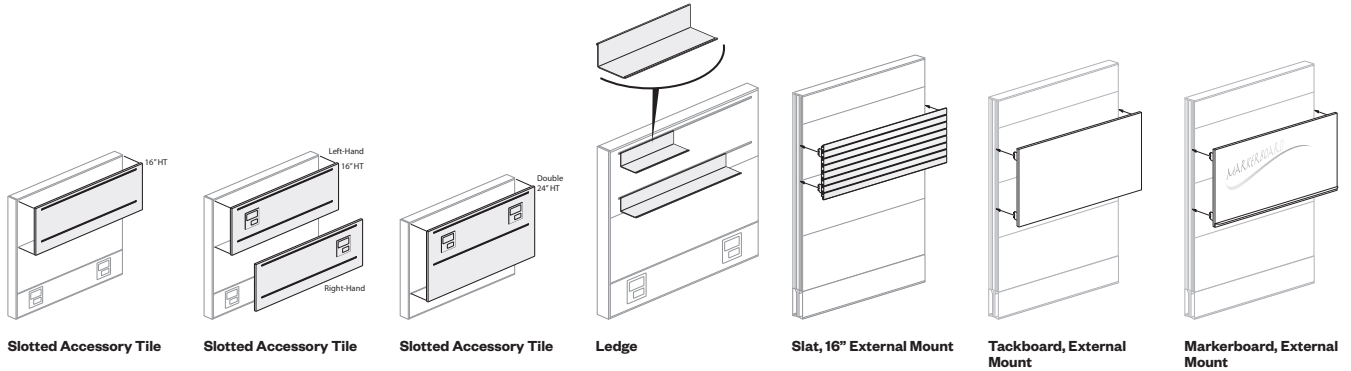

Tiles - Beam Pages 69-73

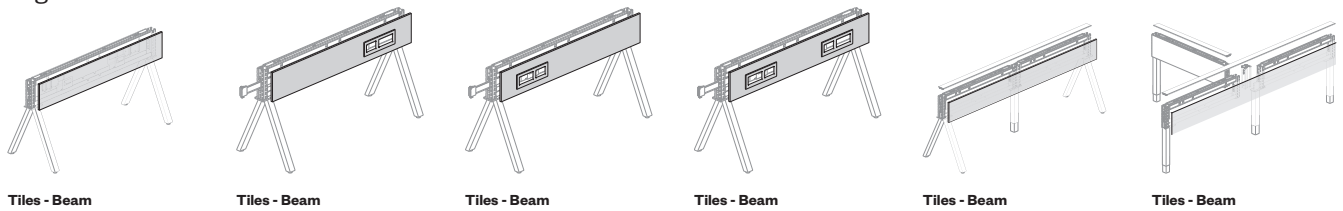

Panel Accessories Pages 74-109

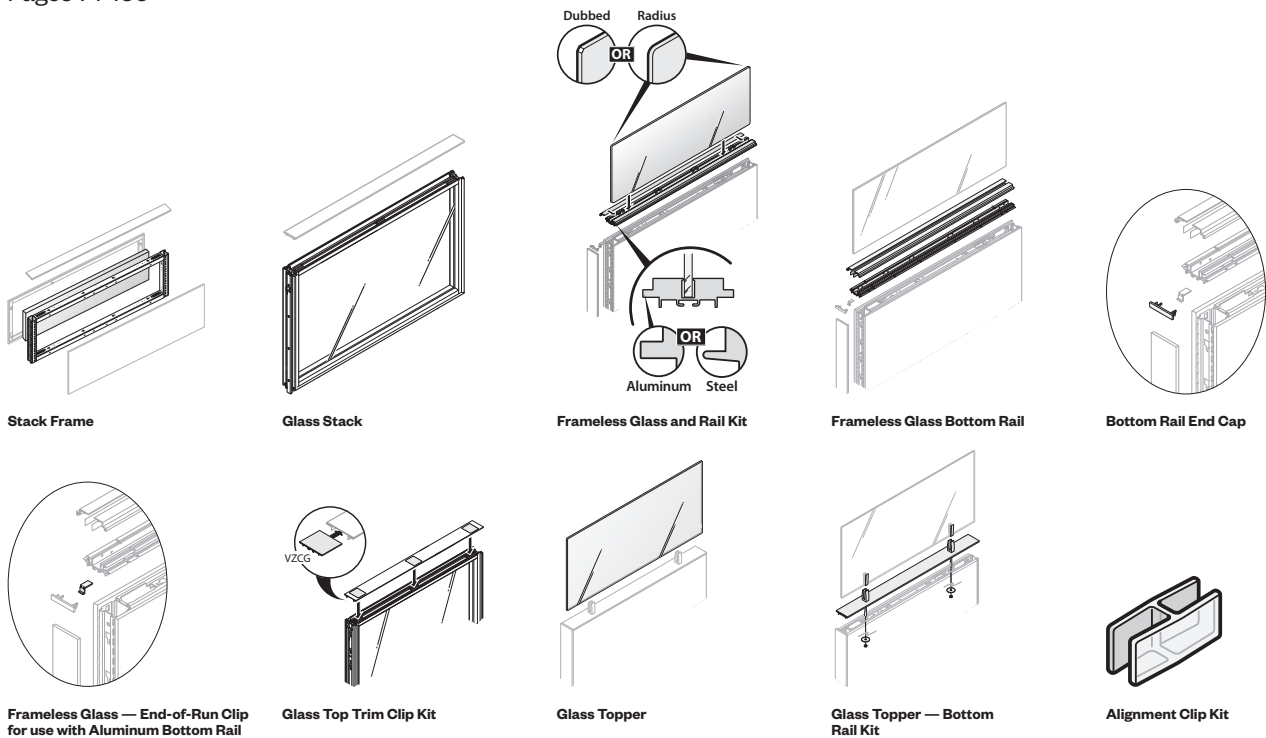

Statement of Line

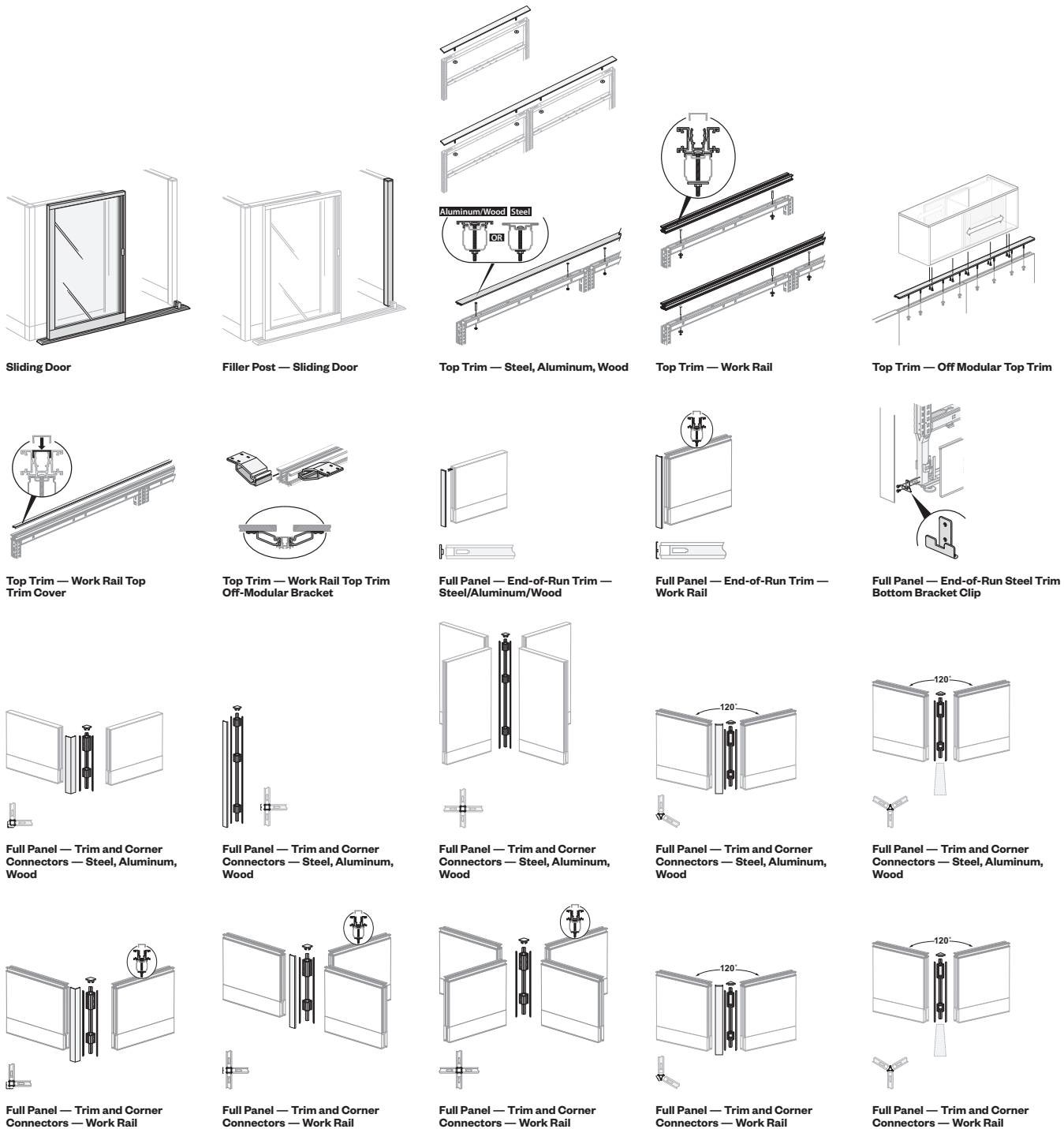

Statement of Line



Full Panel — Trim and Corner Connectors — 3- & 4-Way Intersection — Top Cap



Full Panel — Trim and Corner Connectors — 3- & 4-Way Intersection — Top Cap

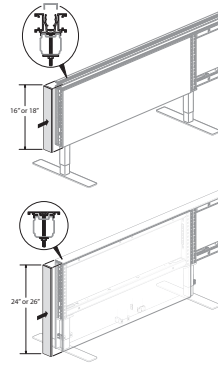

Connections — End-of-Run Trim

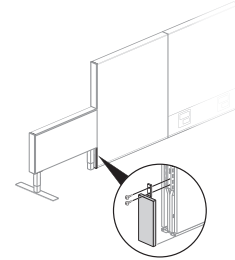

Connections — Raceway End-of-Run Cover

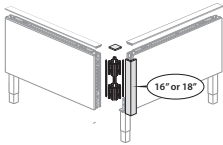

Connections — Trim and Corner Connectors

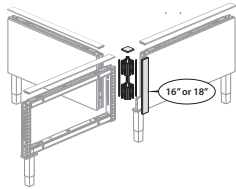

Connections — Trim and Corner Connectors

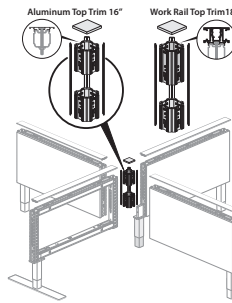

Connections — Trim and Corner Connectors

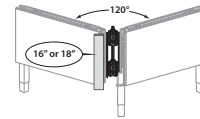

Connections — Trim and Corner Connectors

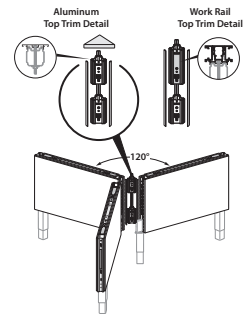

Connections — Trim and Corner Connectors

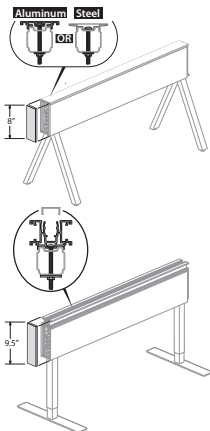

Beam — End-of-Run Trim

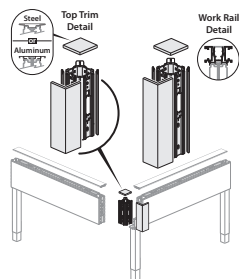

Beam — Trim and Corner Connectors

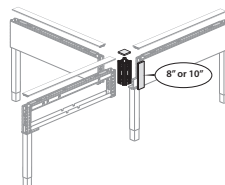

Beam — Trim and Corner Connectors

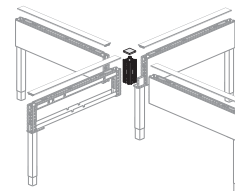

Beam — Trim and Corner Connectors

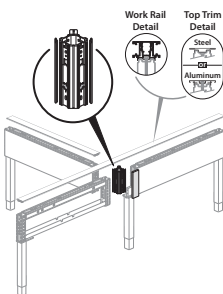

Beam — Trim and Corner Connectors — No Top Cap

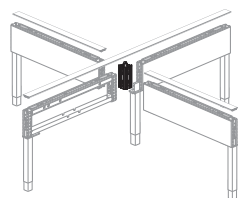

Beam — Trim and Corner Connectors — No Top Cap

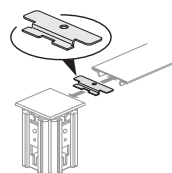

Beam — Steel Trim Top Cap Aligner Clip

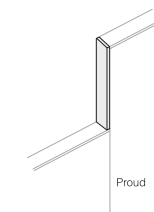

Variable Height Trim — Proud

Statement of Line

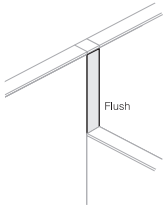

Variable Height Trim 3-Way & 4-Way — Flush 90°



Variable Height Trim (Flush) — 120°

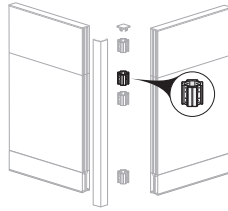

Corner Block Assembly — 90°

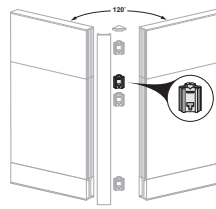

Corner Block Assembly — 120°

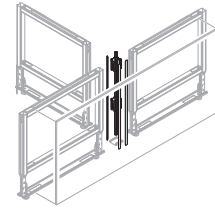

3-Way Intersection — Spanning Tile Corner Blocks

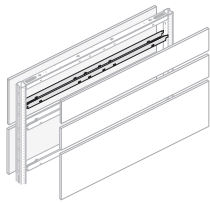

Aligner/Light Block

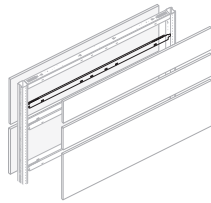

Half Aligner/Light Block

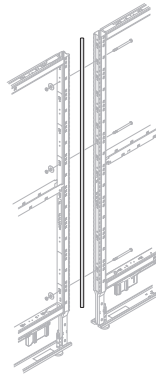

Vertical Light Block (Between Panel)

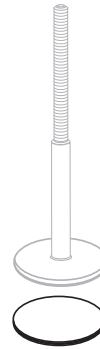

Friction Pad

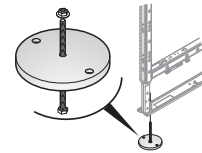

Seismic Anchoring Kit

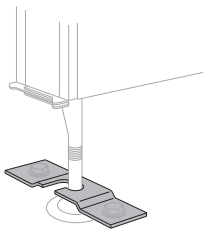

Anchoring Bracket

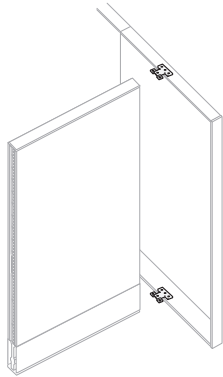

T-Mount

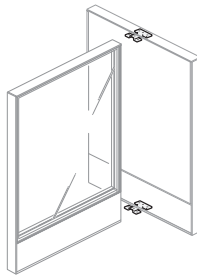

T-Mount

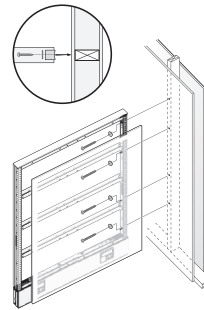

Panel Frame Wall Mount

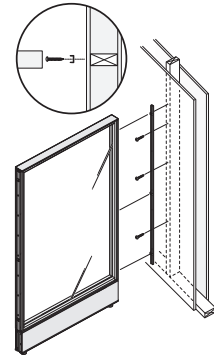

Glass Panel Wall Mount

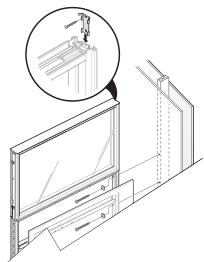

Tie Bracket Kit - Glass Stack

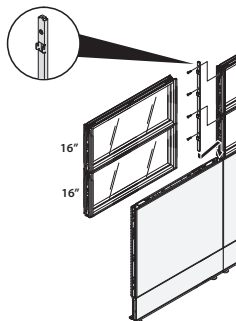

Glass to Glass Connectors — In-Line

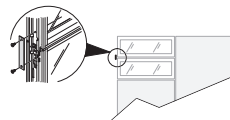

Glass to Glass Connectors — End-of-Run/Intersection



Glass to Glass Connectors — Variable Height

Statement of Line

Electrical Components

Pages 110-144

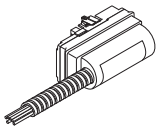

**Base Feed Module —
Hardwire Connection**

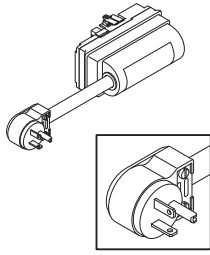

**Single Circuit Base Feed Module —
Receptacle Connection with
Power Cord**

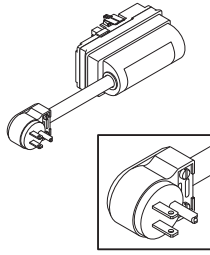

**Single Circuit Base Feed Module —
Receptacle Connection with
Power Cord**

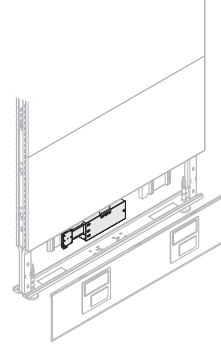

**Base Feed Module — Concealed
Hardwire Connection**

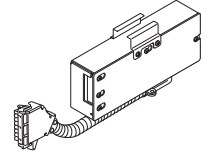

**Base Feed Module — Hardwire
Connection**

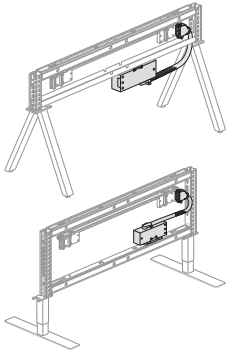

**Base Fee Module — Hardwire Connection —
Connections and Beams**

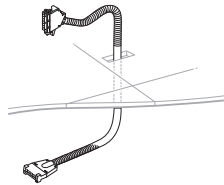

**Internal Power Base AI
Base Feed**

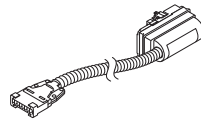

**Raised Floor Infeed Base
Feed Module**

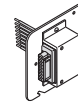

**Wall Feed Field
Wired 1 Port**

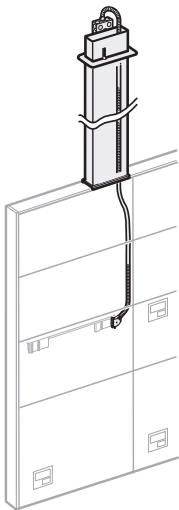

Top Feed Module

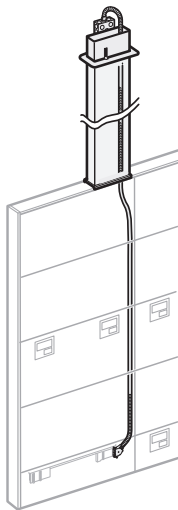

**Top Feed Module — Base
Raceway Connection**

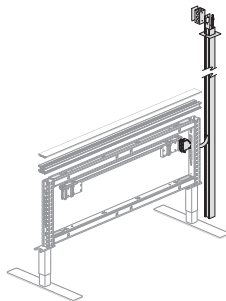

**End-of-Run Top Feed Module —
Connections only**

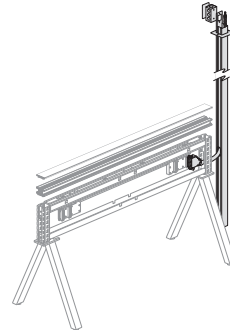

**End-of-Run Top Feed Module —
Beam only**

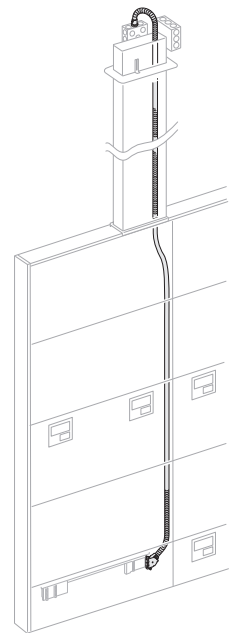

Full Panel Infeed Harness

Statement of Line

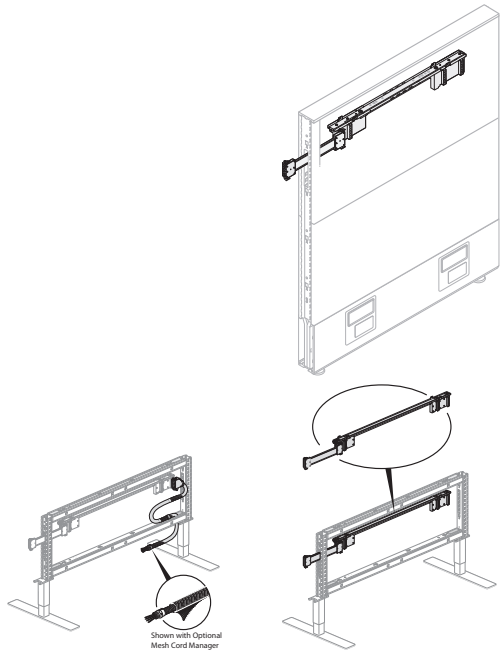

Infeed Harness

Power Retrofit Kit — 42" (1067mm)H Beltline, 58" (1473mm)H Standing Height and Connections

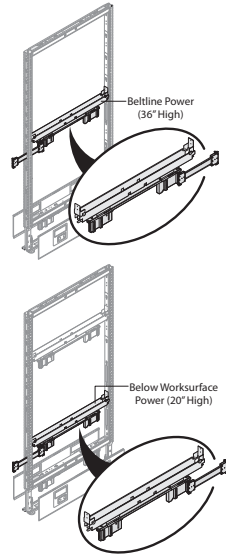

Power Retrofit Kit — Beltline, 50" (1270mm)H or Greater, Below WS and Standing Height

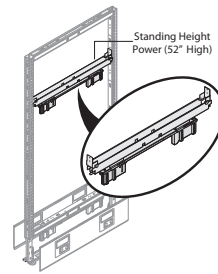

Power Retrofit Kit — Standing Height

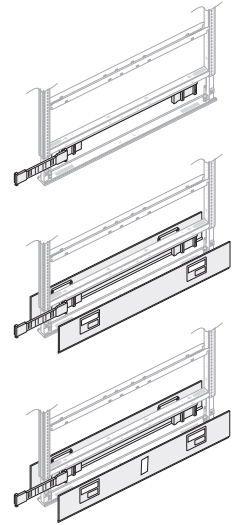

Power Retrofit Kit — Raceway

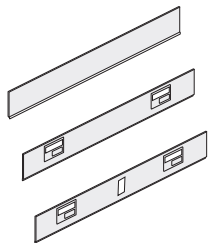

Raceway Covers

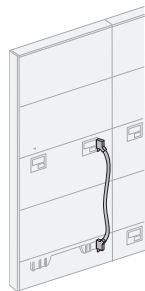

Vertical Power Connector

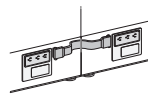

Base straight condition

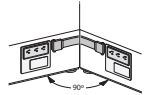

Base inside 90° condition

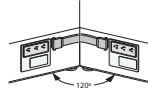

Base inside 120° condition

Flexible Power Connector — Raceway

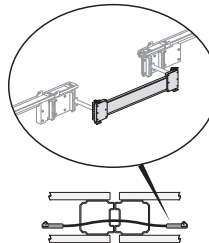

Flexible Power Connector — Work-height

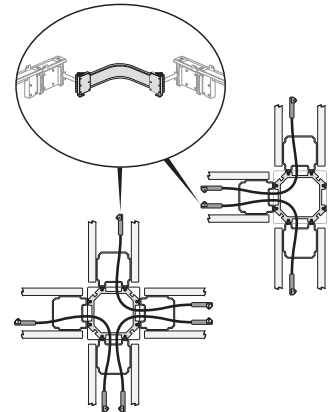

Flexible Power Connector — Corner Span, Work-height

Statement of Line

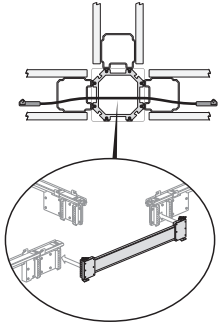

Flexible Power Connector — Straight Span, Raceway/ Work-height

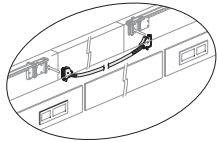

Extended Power Connector

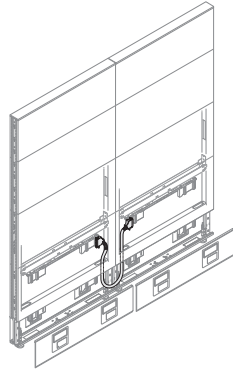

Power Connector — Below WS

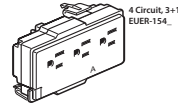
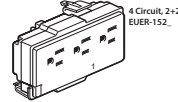
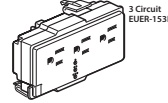
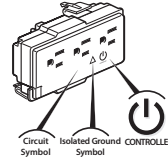

Triplex Receptacle — 15 Amp

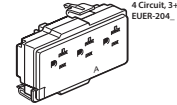
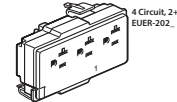
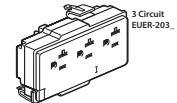
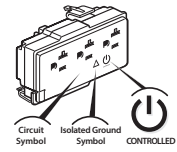

Triplex Receptacle — 20 Amp

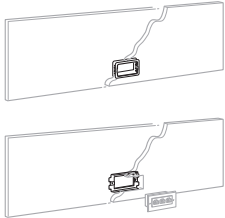

Information Plate Communication Port Kits

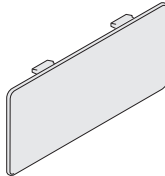

Receptacle Blank Cover

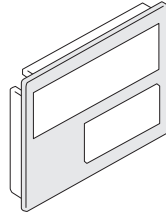

Power and Communication Bezel — Full Panel and Connections

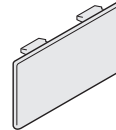

Data Blank Cover — Full Panel and Connections

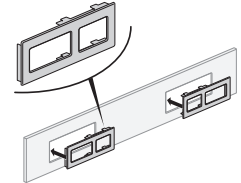

Power and Communication Bezel — Beam

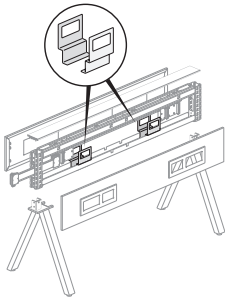

Communication Data Bracket — Beam

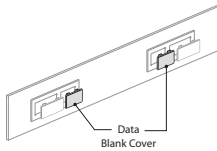

Data Blank Cover — Beam

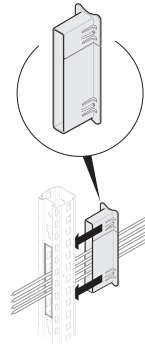

Frame Rail Grommet

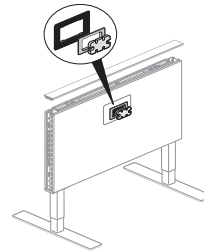

Tile Grommet Kit

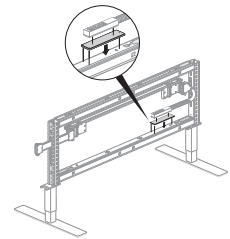

Frame Mounted Power Tap Bracket — Concealed

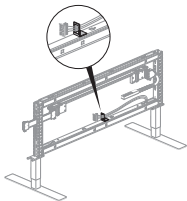

Frame Mounted Data Plate Bracket — Concealed

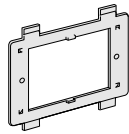

Adaptor Plate, Single Gang

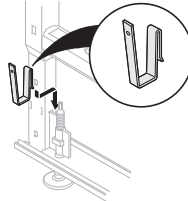

Cable Management Bracket



Compose Task Light Cord Manager

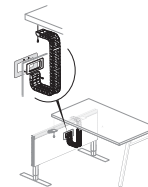

Compose Connections Cable Chain

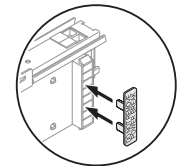

Power Break Marker

Statement of Line

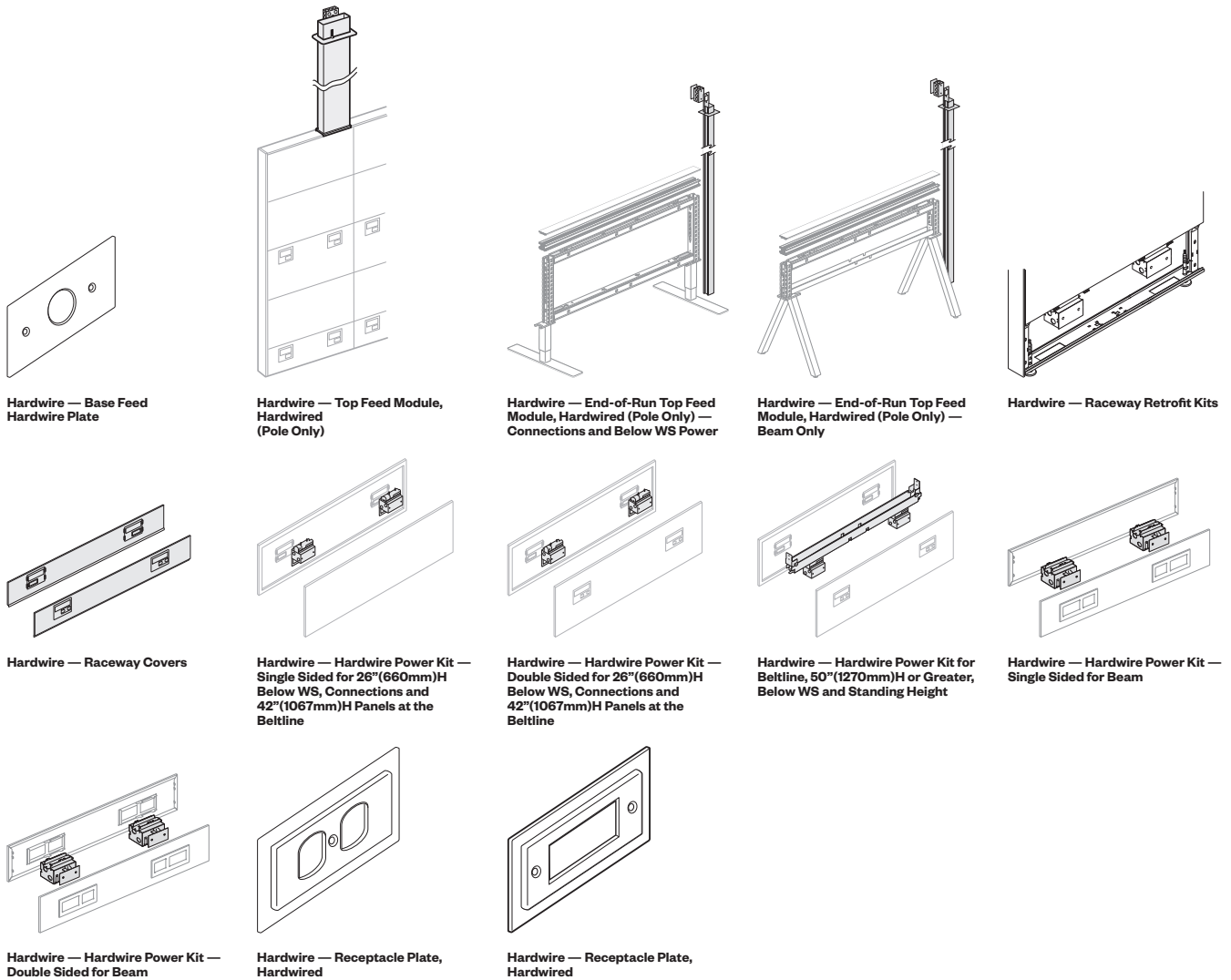

Gallery Panel to Compose Panel End-of-Run

Pages 148-156

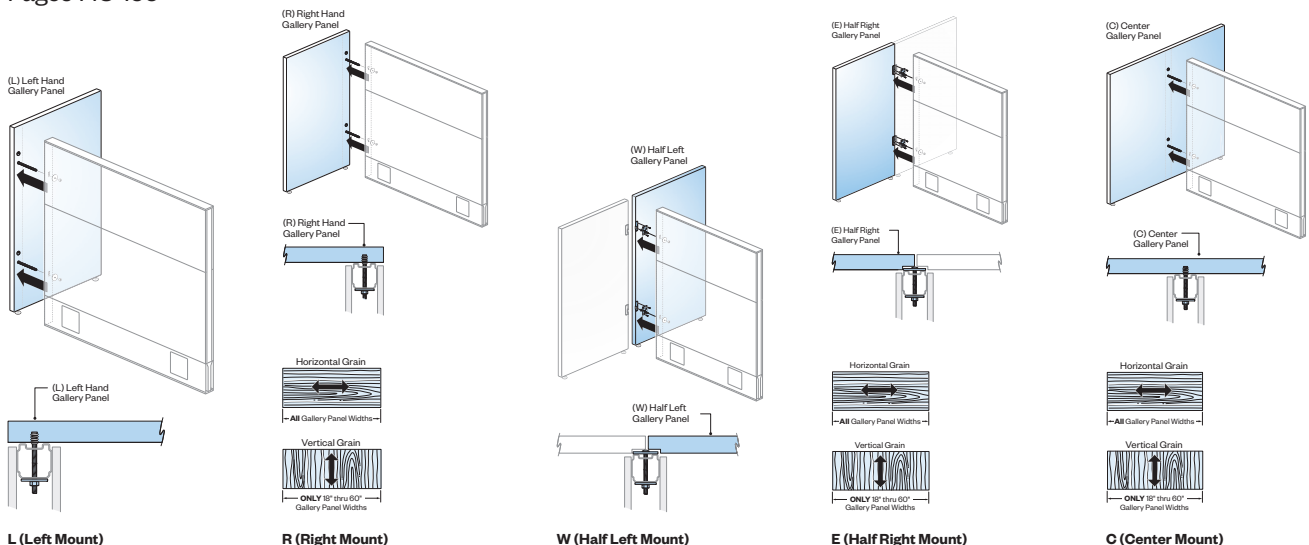

Statement of Line

Gallery Panel to Compose Panel Intermediate

Pages 159-165

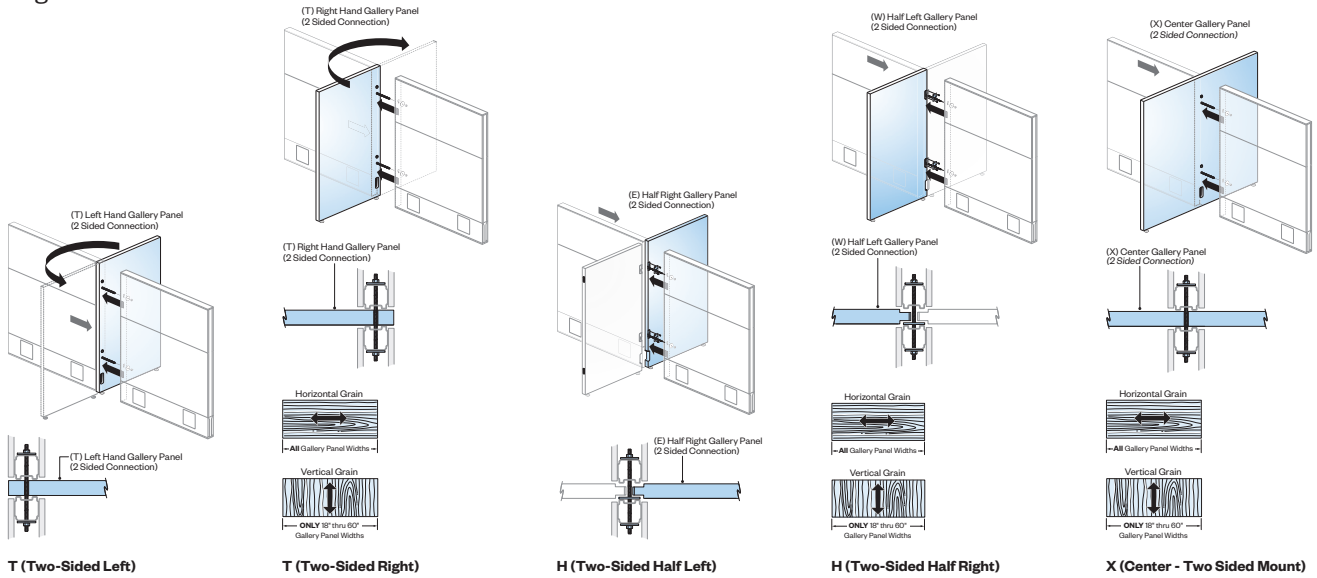

Gallery Panel to Compose Beam End-of-Run

Pages 168-176

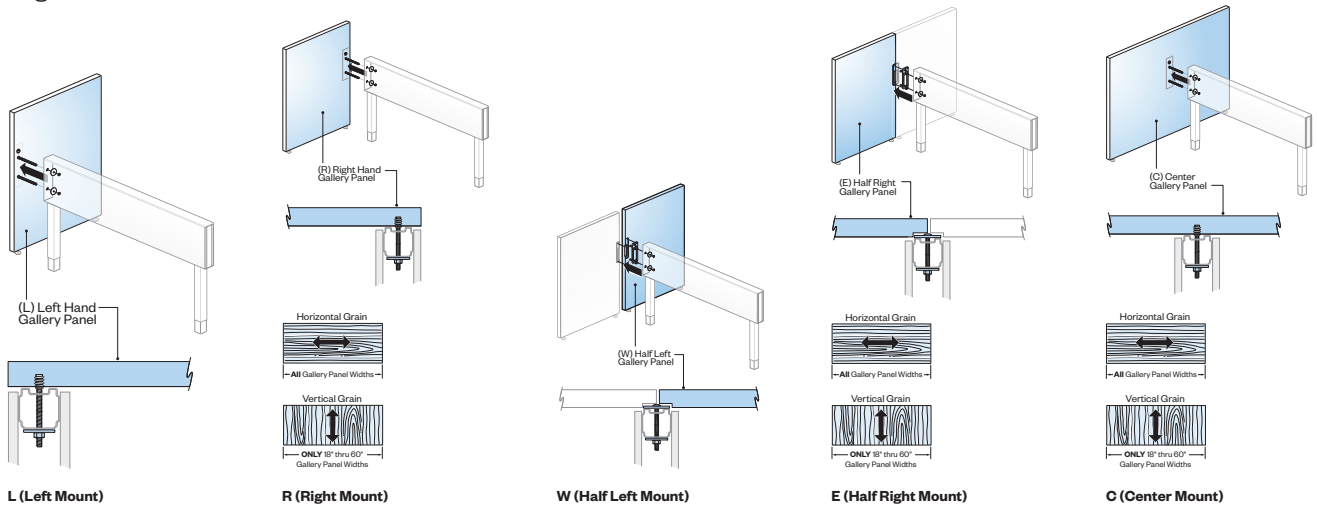

Statement of Line

Gallery Panel to Compose Beam Intermediate

Pages 179-185

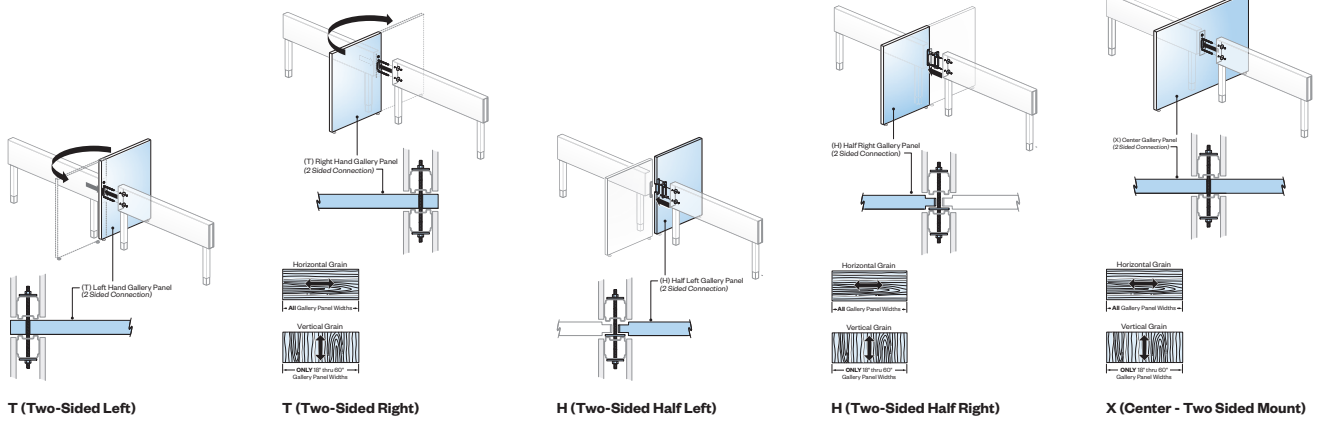

T (Two-Sided Left)

T (Two-Sided Right)

H (Two-Sided Half Left)

H (Two-Sided Half Right)

X (Center - Two Sided Mount)

Gallery Panel to Gallery Panel Face Attachment

Pages 188-191

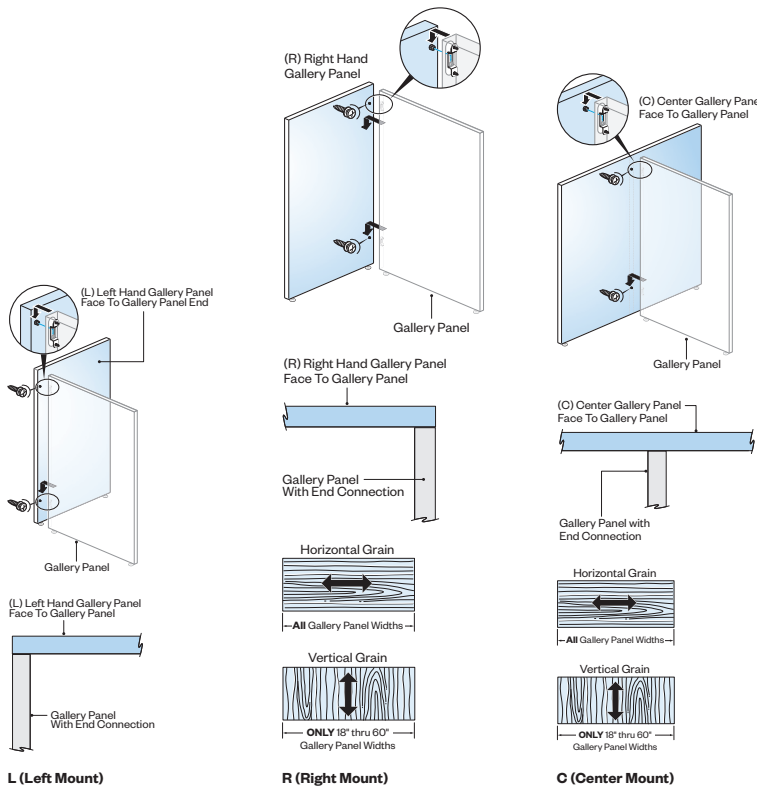

L (Left Mount)

R (Right Mount)

C (Center Mount)

Gallery Panel to Gallery Panel End Attachment

Page 194

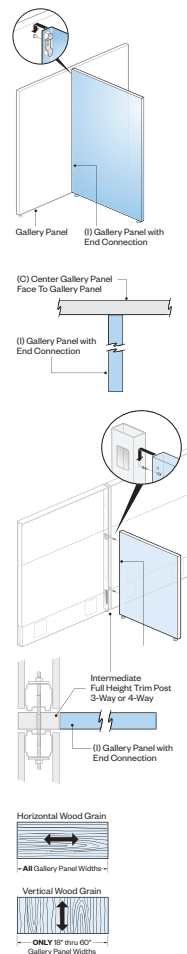

I (90° Face or Post Connection)

Gallery Panel to Gallery Panel Face Attachment

Page 197

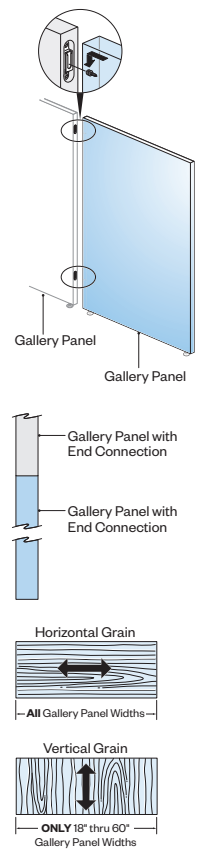

S (Straight In-Line Add-On)

Statement of Line

Gallery Panel Accessories

Pages 200-210

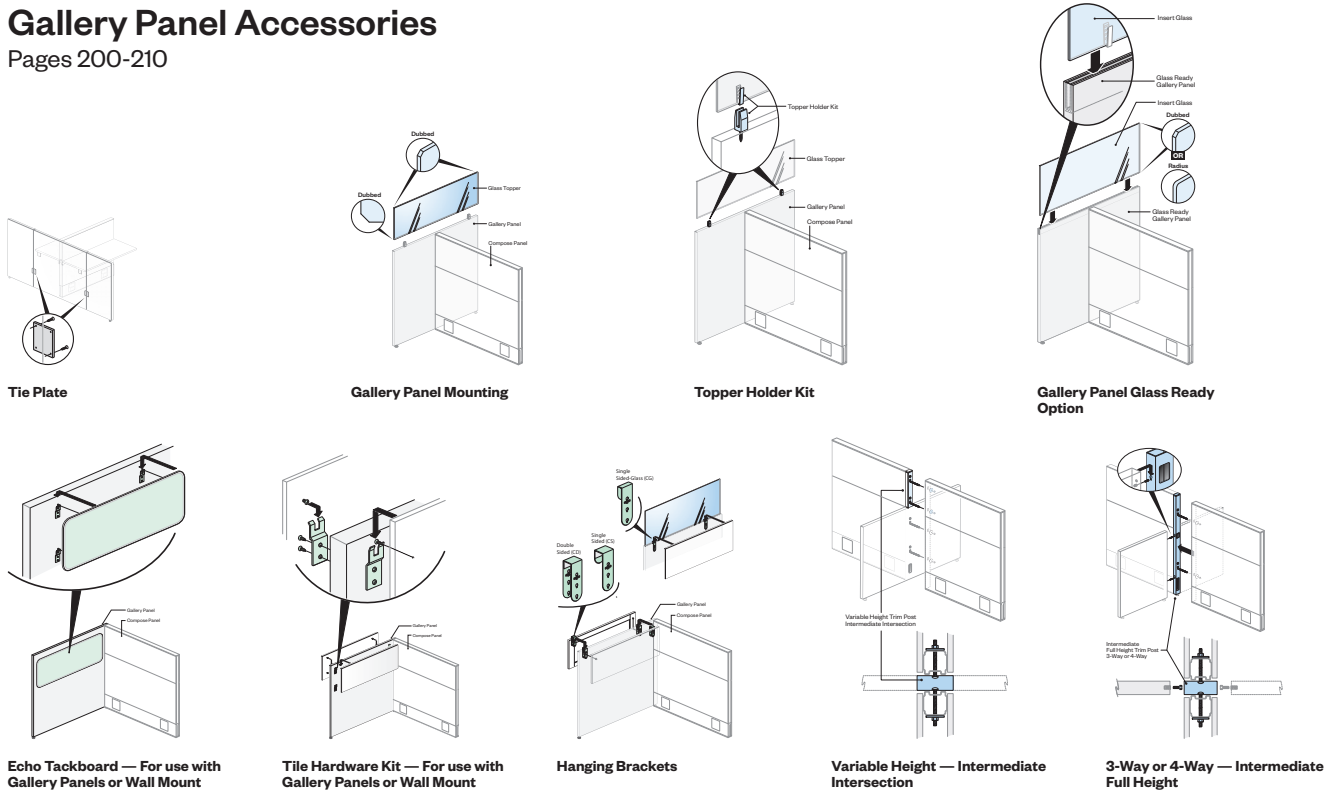

Adaptable Worksurfaces — Rectangular

Pages 213-220

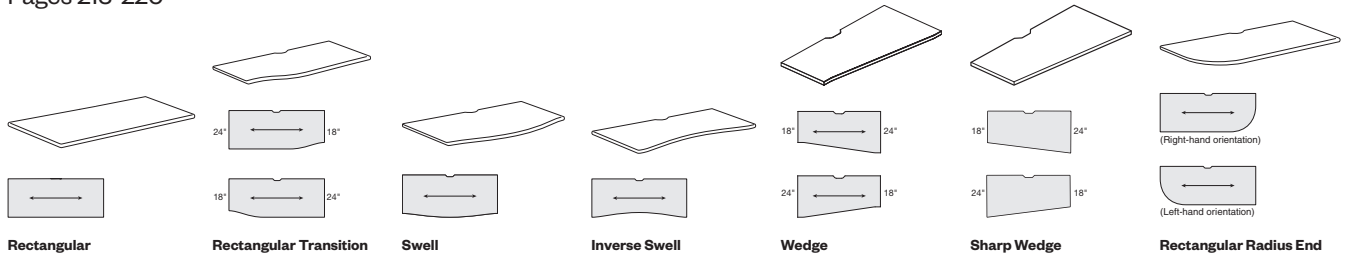

Adaptable Worksurfaces — Corner

Pages 222-235

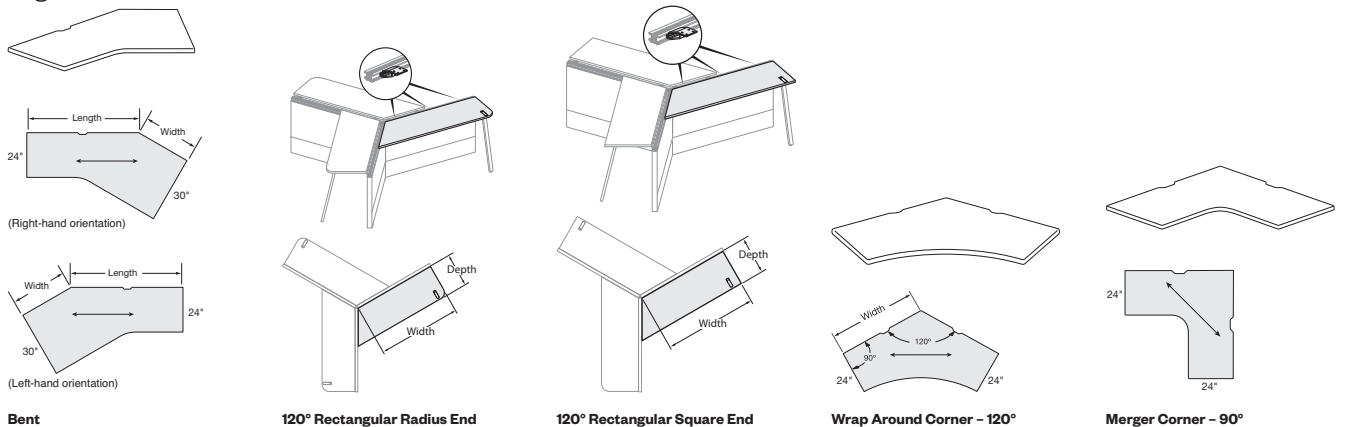

Statement of Line

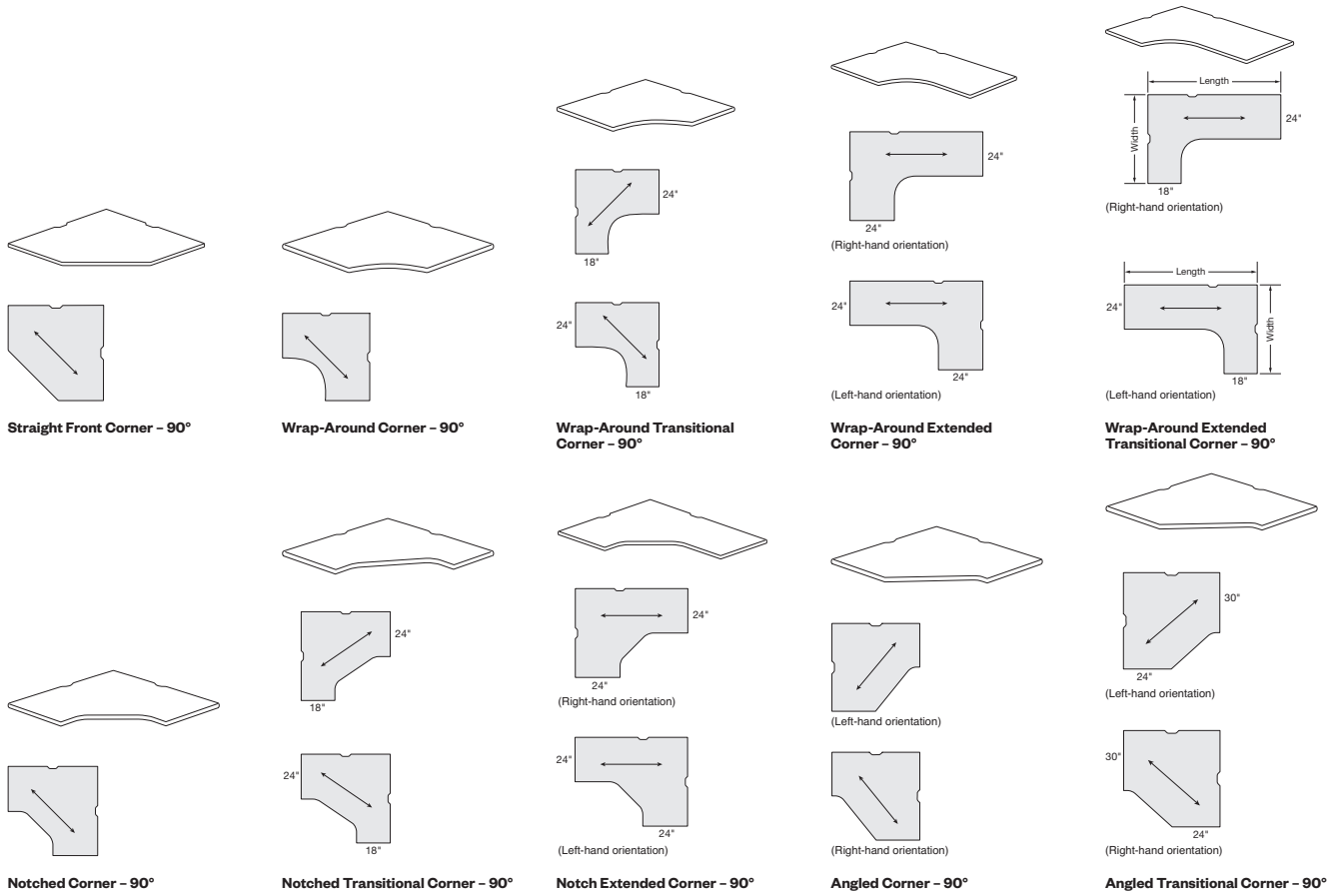

Adaptable Worksurfaces — Convergent

Pages 237-244

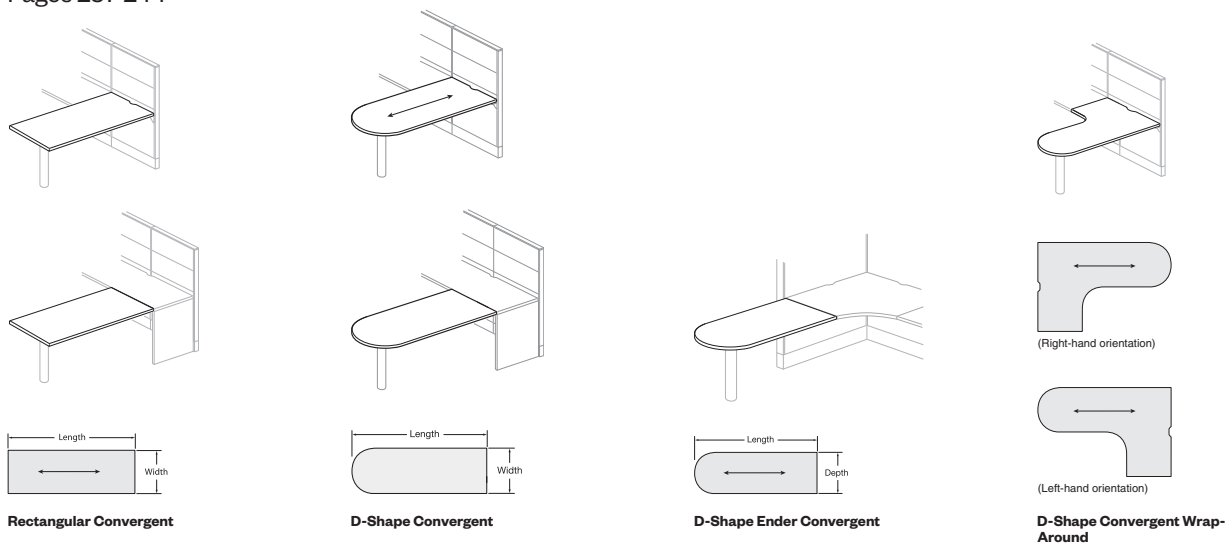

Statement of Line

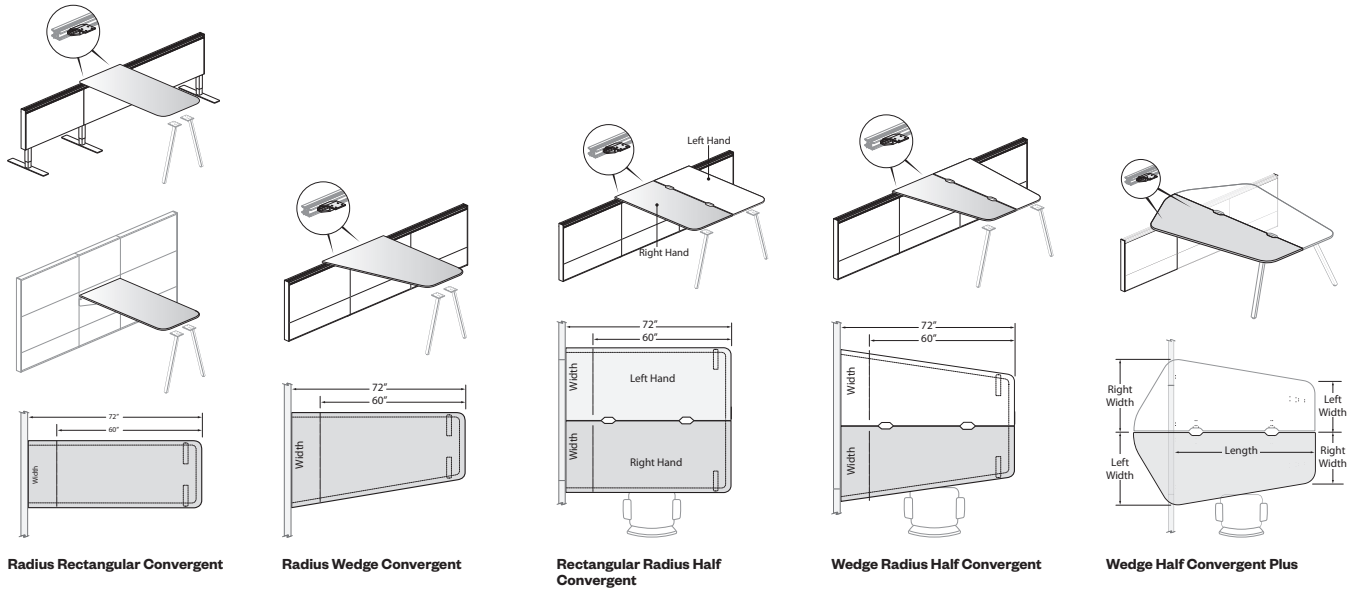

Adaptable Worksurfaces

Pages 245-250

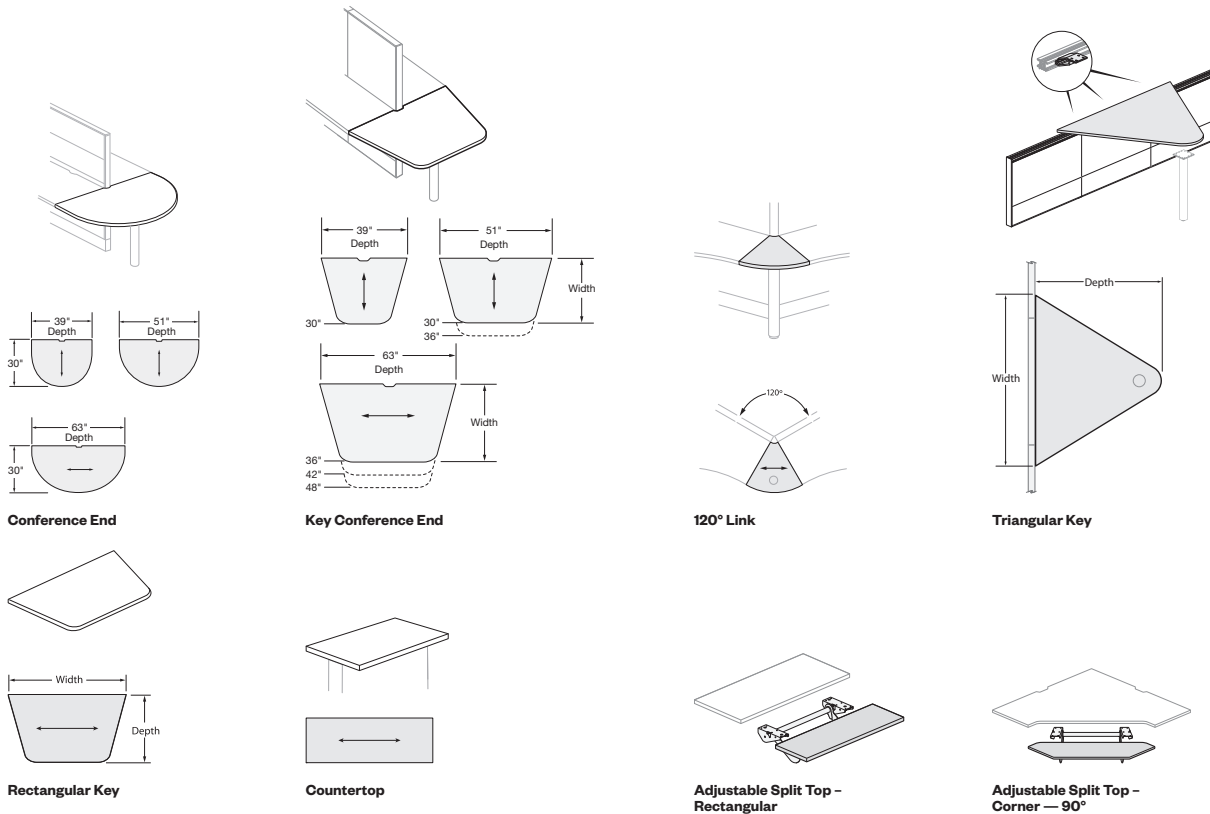

Statement of Line

Worksurface Support — Worksurface Support Panels

Pages 251-252

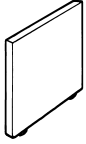

Worksurface Support Panel



Edgeband

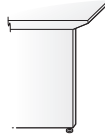

Knife

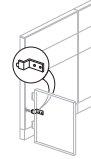

Anti Dislodgement Bracket for use with Worksurface Support Panels

Worksurface Support

Pages 253-262

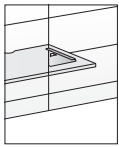

Standard Cantilever Bracket



Standard Mini Cantilever Bracket

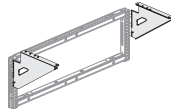

Connections Cantilever Bracket

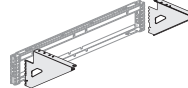

Beam Cantilever Bracket

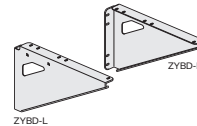

Gallery Panel Cantilever Bracket

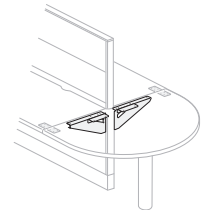

Standard Link Cantilever Bracket

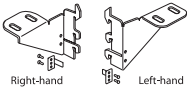

Side/Corner Bracket — Full Panel

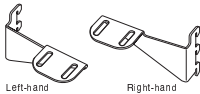

Side/Corner Bracket for use with Knife Edge — Full Panel



Side/Corner Bracket — 26” (660mm)H, Connections or Beam

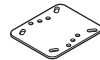

Flush Mount Plate

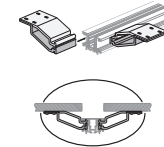

Work Rail Top Trim Off-Modular Bracket

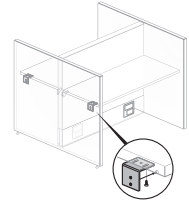

Gallery Panel Attachment Bracket

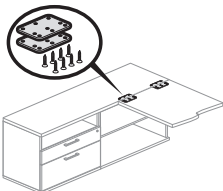

Convergent Bracket

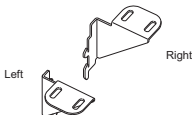

Countertop Bracket Kit

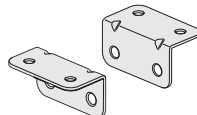

Gallery Panel Countertop/ OSU Bracket Kit

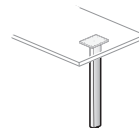

Column Leg



Straight Leg Basic — Height Adjustable



Single Support Leg

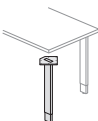

Support Post — Height Adjustable

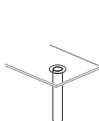

Support Column

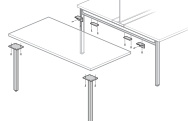

End Leg Kit

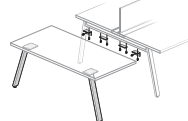

End Leg Kit

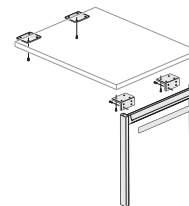

Return Leg Kit

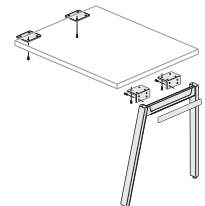

Return Leg Kit

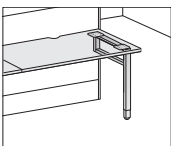

P-Leg

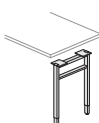

Double Support Leg

Statement of Line

Worksurface Accessories

Pages 263-264

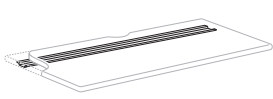

Worksurface Reinforcement Channel

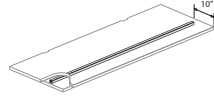

Worksurface Reinforcement Bar

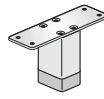

Stanchions

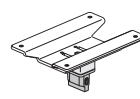

Stanchions

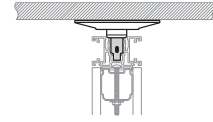

Stanchions

Panel-to-Storage Bracket

Page 265

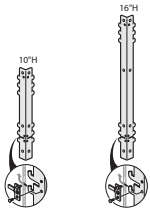

A Series / Be_Hold

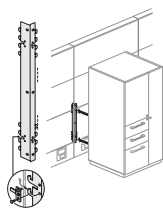

Compose Storage

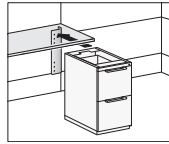

X Series - Attached Pedestal

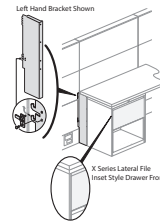

X and V Series Attached 2H Storage

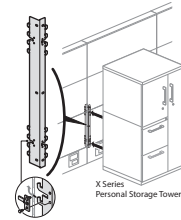

Beside Pantry / X and V Series Freestanding

Upper Storage — Storage Box

Page 267

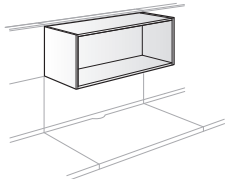

Without Doors

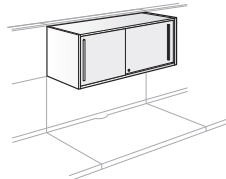

With Doors

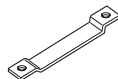

Ganging Flat Bracket for Storage Box

Storage Box Accessories

Page 274

Upper Storage — Adaptable - Overhead Storage Unit

Pages 275-280

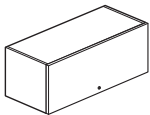

Standard Mount - Flipper Door

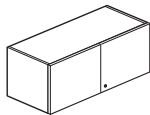

Standard Mount - Cabinet Door

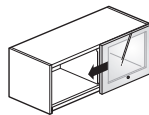

Standard Mount - Single Slider Door

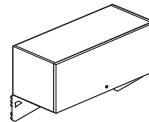

Up Mount - FlipperDoor

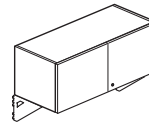

Up Mount - Cabinet Door

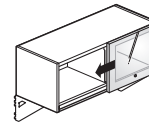

Up Mount - Single Slider Door

Upper Storage — Adaptable

Page 285

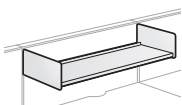

Open Shelf Standard Mount

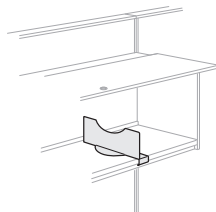

Shelf Divider



Overhead Storage Unit / Shelf Gang Clip

Statement of Line

Wall Mount Components – Overhead Storage Unit

Page 286

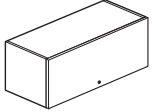

Wall Mount – Flipper Door

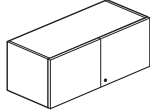

Wall Mount – Cabinet Door

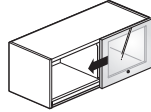

Wall Mount – Single Slider Door

Wall Mount Components

Pages 291-292



Wall Track

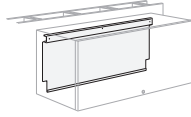

Back for Wall Mounted Overhead Storage Unit

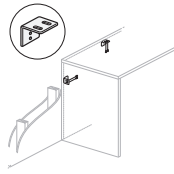

Worksurface and Gallery Panel Wall Mount Bracket

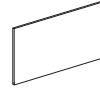

Tackboard, Wall Mount



Markerboard, Wall Mount

Lighting — Task

Pages 293-296

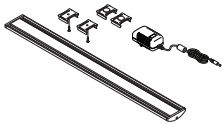

Reed Premiere™ Stand-Alone LED Task Light

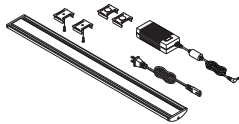

Reed Premier™ Starter LED Task

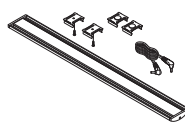

Reed Premiere™ Add-On LED Task Light — For Use with Reed Premier Starter LED Task Lights

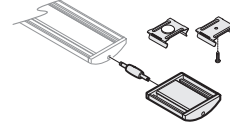

Reed Premier™ Add-On Occupancy Sensor

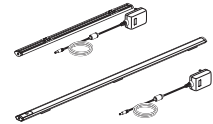

Adaptable LED Task Light - Stand Alone

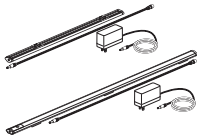

Adaptable LED Task Light - Starter Kit



Adaptable LED Task Light - Add-On Kit

Structures

Power Location Overview - Full Panel Frame

Full Panel Frame – Overview

- Available with or without base raceway 3- or 4-circuit power.
- 24”(610mm) – 72”(1829mm) widths may be powered; 18”(457mm)W powered panels are not available.
- Standing Height Power location is not capable of routing power to an adjacent panel frame. This power height location requires a separately specified Standing Height PDA Kit and is for use with a powered base raceway panel.
- Standard with a panel frame cutout at Beltline for routing power to an adjacent panel frame.

Full Panel Frame – Without Below Worksurface Power

- Beltline Power location may be specified with 3- or 4-circuit Power Distribution Assembly (PDA).

NOTE: Not available with below worksurface cutout in panel frame.

Full Panel Frame – With Below Worksurface Power

- Panel with below worksurface cutouts may be specified with or without 3- or 4-circuit PDA.

Full Panel Frame

– Without Below Worksurface Power

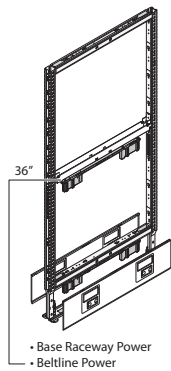

- Beltline Power may be specified for panel heights 42”(1067mm) and greater.

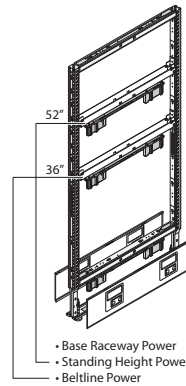

- Beltline power may be specified for panel heights 42”(1067mm) and greater.
- Standing height power is for use with panel heights 58”(1473mm) and greater providing the panel is specified with a powered base raceway; requires a separately specified Standing Height PDA Kit.

Full Panel Frame

– With Below Worksurface Power

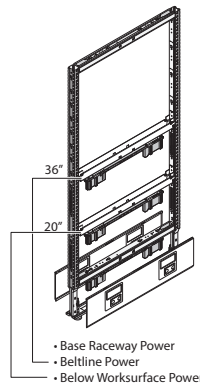
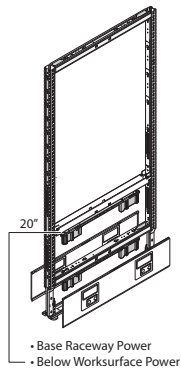

- Beltline power may be specified for panel heights 42”(1067mm) and greater.

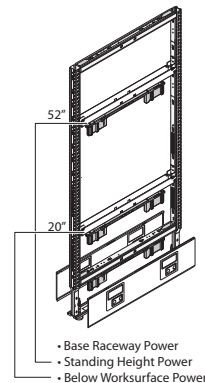

- Standing height power is for use with panel heights 58”(1473mm) and greater providing the panel is specified with a powered base raceway; requires a separately specified Standing Height PDA Kit.

Structures

Full Panel Frames

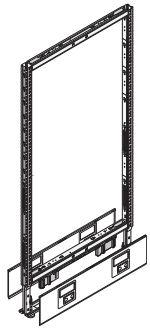

• Base Raceway Power

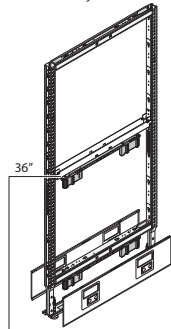

• Base Raceway Power
• Beltline Power

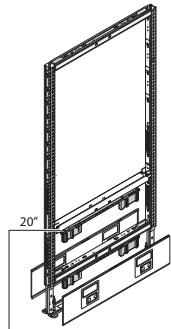

• Base Raceway Power
• Below Worksurface Power

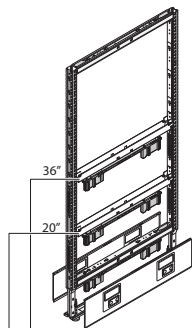

• Base Raceway Power
• Beltline Power
• Below Worksurface Power

VZFF

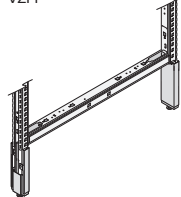

Open Base
VZFF-NNOO
Class BC

Features

- Includes non-powered or powered panel frame assembly, with or without raceway covers, connection hardware, leveling glides and carpet grippers. Power Distribution Assembly/flex connectors included when power is specified.
- Powered frame assembly:
 - Available for countries that utilize 120 volt 60 hertz electrical systems and U.S. configured plugs and outlets.
 - Includes applicable crossbar assembly, power distribution assembly, flex connector and panel data grommet.
- Beltline Power:
 - Includes beltline crossbar assembly, power distribution assembly, flex connector and panel data grommet.
 - Beltline crossbar acts as light block on frames 50"(1270mm) and higher.
- Open Base Option:
 - Includes painted leg covers.
 - Does not include raceway covers, pan or carpet grippers.
- Aligner/light blocks can be specified separately for increased rigidity for full-height fabric tiles or as a light block for any segmented tile surface.
- Frame thickness 2"(51mm); overall panel thickness is 3"(76mm)
- Base raceway is 8"(203mm)H.
- Black finish on frame.
- Shipped assembled with pan, power and glides when applicable.

Specification Tips

- Requires separately specified:
 - Tiles (each side specified separately).
 - Top trim.
 - End-of-Run trim or 2-, 3-, 4-Way trim as needed per application.
 - Receptacles for powered panels (each side specified separately).
 - Receptacle blanks and data covers (if applicable).
- 18"(457mm)W frame available as non-powered only.
- 24"(610mm)-72"(1829mm)W frames available with power at base, beltline or below worksurface.
- Below worksurface cutout is only included when specified as Cutout or powered.
- No Raceway Cover Option:
 - Frames may be non-powered or may have base raceway and/or beltline power.
 - Requires separately specified tile-to-floor in place of base raceway cover.
- Beltline Power Option:
 - Available on panel frames 42"(1067mm)H or greater.
 - Not interchangeable with non-beltline or below worksurface retrofit kits.
- Standing Height Power -
 - For use with panels 58"(1473mm)H or greater with a powered base raceway
 - Requires separately specified stand height PDA kit.
- Open Base Option:
 - Frames have a non-powered base.
 - Will have an 8"(203mm) open space beneath panel frame.
 - Will not accept tile-to-floor.
 - Cannot be retrofitted to closed base with raceways.
 - Cannot be specified with T-Mount Kit.
- Flex Connectors -
 - Provided for base, beltline and below worksurface powered panel frame; accommodates straight-in-line and inside 90° conditions.
- When routing through a Gallery Panel use a Corner Span Work Height Connector. Separately specified.
- New York City (NYC) electrical - requires field installation of PDA.
- Refer to 10-Wire Power Price List for 4-4-2, 6-2-2 and International Power options for use on Compose at the base only.
- Hardwire (Chicago) power option includes two double sided junction boxes and four blank cover plates; see Hardwire power options for additional components.
- Applications greater than 69"(1753mm)H may be restricted by some building codes. Consult your local code authority to assure furniture layout is compliant.
- Refer to Specification Guide for Planning with Structures.
- Do not mix 3-circuit and 6-circuit with 4-circuit components. Do not mix 2+2 and 3+1 components. Components have unique polarity key and color coding (3-circuit=black, 6-circuit=ivory, 2+2=blue and 3+1=green).

Notes: Upcharge for mixed grade fabric or trim surfaces, refer to the electronic design and specification tools for pricing.
72"(1829mm)W is not available in 74"(1880mm)H.

To Order, Specify:

1) Product number, including:

1 Base Raceway Power Option

N Non-Powered

3-Circuit:

3 3-Circuit (add **\$279.74** list)

Y New York City (add **\$279.74** list)

C Hardwire (Chicago) (add **\$342.67** list)

4-Circuit 2+2:

2 4-Circuit 2+2 (add **\$309.44** list)

W New York City (add **\$309.44** list)

4-Circuit 3+1:

4 4-Circuit 3+1 (add **\$309.44** list)

V New York City (add **\$309.44** list)

2 Raceway Cover Side One

N No Raceway Cover (tile to floor) (deduct **\$24.68** list)

O Open Base Option (add **\$251.44** list)

H Raceway Cover with knockouts (not available on 18"(457mm)W, 24"(610mm)W has one set of knockouts on left side)

B Raceway Cover without knockouts

3 Raceway Cover Side Two

N No Raceway Cover (tile to floor) (deduct **\$24.68** list)

O Open Base Option; no upcharge

H Raceway Cover with knockouts (not available on 18"(457mm)W, 24"(610mm)W has one set of knockouts on left side)

B Raceway Cover without knockouts

4 Beltline Power

N No Beltline Power

3-Circuit:

3 3-Circuit (add **\$590.92** list)

Y New York City (add **\$590.92** list)

4-Circuit 2+2:

2 4-Circuit 2+2 (add **\$590.92** list)

W New York City (add **\$590.92** list)

4-Circuit 3+1:

4 4-Circuit 3+1 (add **\$590.92** list)

V New York City (add **\$590.92** list)

5 Below Worksurface Power

No Cutout (Blank, No Selection)

U Cutout only (add **\$78.56** list)

3-Circuit:

3 3-Circuit (add **\$717.32** list)

Y New York City (add **\$717.32** list)

4-Circuit 2+2:

2 4-Circuit 2+2 (add **\$717.32** list)

W New York City (add **\$717.32** list)

4-Circuit 3+1:

4 4-Circuit 3+1 (add **\$717.32** list)

V New York City (add **\$717.32** list)

2) Trim color for pan or leg cover.

3) Trim color for raceway cover side 1.

4) Trim color for raceway cover side 2.

Structures

Full Panel Frames

Nominal Height	Nominal Width	Number ①②③④⑤	Trim	
			A	B
26"(660mm)	18"(457mm)	VZFF-2618-NN <input type="checkbox"/> <input type="checkbox"/> NR <input type="checkbox"/>	\$402.90	\$ 411.64
	24"(610mm)	VZFF-2624-N <input type="checkbox"/> <input type="checkbox"/> NR <input type="checkbox"/>	429.11	441.37
	30"(762mm)	VZFF-2630-N <input type="checkbox"/> <input type="checkbox"/> NR <input type="checkbox"/>	455.32	471.10
	36"(914mm)	VZFF-2636-N <input type="checkbox"/> <input type="checkbox"/> NR <input type="checkbox"/>	481.53	500.83
	42"(1067mm)	VZFF-2642-N <input type="checkbox"/> <input type="checkbox"/> NR <input type="checkbox"/>	507.74	530.56
	48"(1219mm)	VZFF-2648-N <input type="checkbox"/> <input type="checkbox"/> NR <input type="checkbox"/>	533.95	560.29
	54"(1372mm)	VZFF-2654-N <input type="checkbox"/> <input type="checkbox"/> NR <input type="checkbox"/>	560.16	590.02
	60"(1524mm)	VZFF-2660-N <input type="checkbox"/> <input type="checkbox"/> NR <input type="checkbox"/>	586.37	619.75
	72"(1829mm)	VZFF-2672-N <input type="checkbox"/> <input type="checkbox"/> NR <input type="checkbox"/>	728.31	768.73
34"(864mm)	18"(457mm)	VZFF-3418-NN <input type="checkbox"/> <input type="checkbox"/> NR <input type="checkbox"/>	\$ 528.86	\$ 537.60
	24"(610mm)	VZFF-3424-N <input type="checkbox"/> <input type="checkbox"/> NR <input type="checkbox"/>	555.07	567.33
	30"(762mm)	VZFF-3430-N <input type="checkbox"/> <input type="checkbox"/> NR <input type="checkbox"/>	581.28	597.06
	36"(914mm)	VZFF-3436-N <input type="checkbox"/> <input type="checkbox"/> NR <input type="checkbox"/>	607.49	626.79
	42"(1067mm)	VZFF-3442-N <input type="checkbox"/> <input type="checkbox"/> NR <input type="checkbox"/>	633.70	656.52
	48"(1219mm)	VZFF-3448-N <input type="checkbox"/> <input type="checkbox"/> NR <input type="checkbox"/>	659.91	686.25
	54"(1372mm)	VZFF-3454-N <input type="checkbox"/> <input type="checkbox"/> NR <input type="checkbox"/>	686.12	715.98
	60"(1524mm)	VZFF-3460-N <input type="checkbox"/> <input type="checkbox"/> NR <input type="checkbox"/>	712.33	745.71
	72"(1829mm)	VZFF-3472-N <input type="checkbox"/> <input type="checkbox"/> NR <input type="checkbox"/>	854.27	894.69
42"(1067mm)	18"(457mm)	VZFF-4218-NN <input type="checkbox"/> <input type="checkbox"/> NR <input type="checkbox"/>	\$ 548.54	\$ 557.28
	24"(610mm)	VZFF-4224-N <input type="checkbox"/> <input type="checkbox"/> <input type="checkbox"/> R <input type="checkbox"/>	574.75	587.01
	30"(762mm)	VZFF-4230-N <input type="checkbox"/> <input type="checkbox"/> <input type="checkbox"/> R <input type="checkbox"/>	600.96	616.74
	36"(914mm)	VZFF-4236-N <input type="checkbox"/> <input type="checkbox"/> <input type="checkbox"/> R <input type="checkbox"/>	627.17	646.47
	42"(1067mm)	VZFF-4242-N <input type="checkbox"/> <input type="checkbox"/> <input type="checkbox"/> R <input type="checkbox"/>	653.38	676.20
	48"(1219mm)	VZFF-4248-N <input type="checkbox"/> <input type="checkbox"/> <input type="checkbox"/> R <input type="checkbox"/>	679.59	705.93
	54"(1372mm)	VZFF-4254-N <input type="checkbox"/> <input type="checkbox"/> <input type="checkbox"/> R <input type="checkbox"/>	705.80	735.66
	60"(1524mm)	VZFF-4260-N <input type="checkbox"/> <input type="checkbox"/> <input type="checkbox"/> R <input type="checkbox"/>	732.01	765.39
	72"(1829mm)	VZFF-4272-N <input type="checkbox"/> <input type="checkbox"/> <input type="checkbox"/> R <input type="checkbox"/>	873.95	914.37
50"(1270mm)	18"(457mm)	VZFF-5018-NN <input type="checkbox"/> <input type="checkbox"/> NR <input type="checkbox"/>	\$ 568.22	\$ 576.96
	24"(610mm)	VZFF-5024-N <input type="checkbox"/> <input type="checkbox"/> <input type="checkbox"/> R <input type="checkbox"/>	594.43	606.69
	30"(762mm)	VZFF-5030-N <input type="checkbox"/> <input type="checkbox"/> <input type="checkbox"/> R <input type="checkbox"/>	620.64	636.42
	36"(914mm)	VZFF-5036-N <input type="checkbox"/> <input type="checkbox"/> <input type="checkbox"/> R <input type="checkbox"/>	646.85	666.15
	42"(1067mm)	VZFF-5042-N <input type="checkbox"/> <input type="checkbox"/> <input type="checkbox"/> R <input type="checkbox"/>	673.06	695.88
	48"(1219mm)	VZFF-5048-N <input type="checkbox"/> <input type="checkbox"/> <input type="checkbox"/> R <input type="checkbox"/>	699.27	725.61
	54"(1372mm)	VZFF-5054-N <input type="checkbox"/> <input type="checkbox"/> <input type="checkbox"/> R <input type="checkbox"/>	725.48	755.34
	60"(1524mm)	VZFF-5060-N <input type="checkbox"/> <input type="checkbox"/> <input type="checkbox"/> R <input type="checkbox"/>	767.44	800.82
	72"(1829mm)	VZFF-5072-N <input type="checkbox"/> <input type="checkbox"/> <input type="checkbox"/> R <input type="checkbox"/>	893.63	934.05
58"(1473mm)	18"(457mm)	VZFF-5818-NN <input type="checkbox"/> <input type="checkbox"/> NR <input type="checkbox"/>	\$ 587.90	\$ 596.64
	24"(610mm)	VZFF-5824-N <input type="checkbox"/> <input type="checkbox"/> <input type="checkbox"/> R <input type="checkbox"/>	614.11	626.37
	30"(762mm)	VZFF-5830-N <input type="checkbox"/> <input type="checkbox"/> <input type="checkbox"/> R <input type="checkbox"/>	640.32	656.10
	36"(914mm)	VZFF-5836-N <input type="checkbox"/> <input type="checkbox"/> <input type="checkbox"/> R <input type="checkbox"/>	666.53	685.83
	42"(1067mm)	VZFF-5842-N <input type="checkbox"/> <input type="checkbox"/> <input type="checkbox"/> R <input type="checkbox"/>	692.74	715.56
	48"(1219mm)	VZFF-5848-N <input type="checkbox"/> <input type="checkbox"/> <input type="checkbox"/> R <input type="checkbox"/>	731.42	757.76
	54"(1372mm)	VZFF-5854-N <input type="checkbox"/> <input type="checkbox"/> <input type="checkbox"/> R <input type="checkbox"/>	757.63	787.49
	60"(1524mm)	VZFF-5860-N <input type="checkbox"/> <input type="checkbox"/> <input type="checkbox"/> R <input type="checkbox"/>	799.59	832.97
	72"(1829mm)	VZFF-5872-N <input type="checkbox"/> <input type="checkbox"/> <input type="checkbox"/> R <input type="checkbox"/>	925.78	966.20

Structures

Full Panel Frames

Nominal Height	Nominal Width	Number ①②③④⑤	Trim	
			A	B
66"(1676mm)	18"(457mm)	VZFF-6618-NN ■ ■ NR ■	\$ 607.58	\$ 616.32
	24"(610mm)	VZFF-6624-N ■ ■ ■ ■ R ■	633.79	646.05
	30"(762mm)	VZFF-6630-N ■ ■ ■ ■ R ■	660.00	675.78
	36"(914mm)	VZFF-6636-N ■ ■ ■ ■ R ■	686.21	705.51
	42"(1067mm)	VZFF-6642-N ■ ■ ■ ■ R ■	712.42	735.24
	48"(1219mm)	VZFF-6648-N ■ ■ ■ ■ R ■	754.54	780.88
	54"(1372mm)	VZFF-6654-N ■ ■ ■ ■ R ■	780.75	810.61
	60"(1524mm)	VZFF-6660-N ■ ■ ■ ■ R ■	822.71	856.09
	72"(1829mm)	VZFF-6672-N ■ ■ ■ ■ R ■	948.90	989.32
74"(1880mm)	18"(457mm)	VZFF-7418-NN ■ ■ NR ■	\$ 621.09	\$ 629.83
	24"(610mm)	VZFF-7424-N ■ ■ ■ ■ R ■	647.30	659.56
	30"(762mm)	VZFF-7430-N ■ ■ ■ ■ R ■	673.51	689.29
	36"(914mm)	VZFF-7436-N ■ ■ ■ ■ R ■	699.72	719.02
	42"(1067mm)	VZFF-7442-N ■ ■ ■ ■ R ■	725.93	748.75
	48"(1219mm)	VZFF-7448-N ■ ■ ■ ■ R ■	771.49	797.83
	54"(1372mm)	VZFF-7454-N ■ ■ ■ ■ R ■	797.70	827.56
	60"(1524mm)	VZFF-7460-N ■ ■ ■ ■ R ■	839.66	873.04

Structures

Glass Panels

Glass Panel

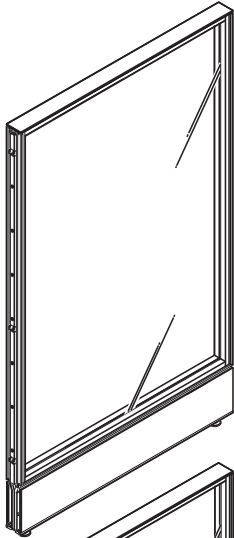

with Raceway Cover

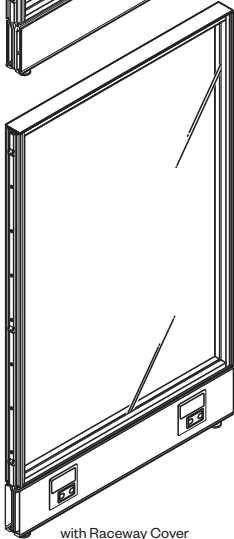

without Raceway Cover

VZGF
Class BC

Features

- Includes non-powered or powered panel assembly, two-piece base raceway cover (if applicable), leveling glides and carpet gripper. Power distribution assembly/flex connector(s) included when power is specified.
- Single pane glass, centered; standard - largest panel up to 48"(1219mm)W glass.
- Panel thickness is 3"(76mm).
- Powered panels are available for countries that utilize 120 volt 60 hertz electrical systems and U.S. configured plugs and outlets.
- Base raceway is 8"(203mm)H.
- Shipped assembled; raceway covers shipped separately.

Specification Tips

- **Requires separately specified top trim.**
- Not for use with Work Rail Top Trim.
- 18"(457mm)W available as non-powered only.
- **Power available on 24"(610mm)- to 48"(1219mm)W only.**
- Non-load bearing.
- Will not accept stack frame, glass stack countertop or panel hung components or attachment to slider door.
- Flex connectors provided for powered panels accommodate straight in-line, inside 90° conditions.
- **Receptacles for powered panels must be specified separately.**
- **Receptacle blank cover and data covers at base must be specified separately.**
- No raceway cover option only available on Non-Powered panels.
- New York City (NYC) electrical requires field installation of PDA.
- International Power - specify non-powered frame and refer to 10-Wire Power Price List for 4-4-2, 6-2-2 and International Power options.
- Applications greater than 69"(1753mm)H may be restricted by some building codes. Consult your local code authority to assure furniture layout is compliant.
- Do not mix 3-circuit and 6-circuit with 4-circuit components. Do not mix 2+2 and 3+1 components. Components have unique polarity key and color coding (3-circuit=black, 6-circuit=ivory, 2+2=blue and 3+1=green).

To Order, Specify:

1) Product number, including:

1 Base Raceway Power Option

N Non-Powered

3-Circuit:

3 3-Circuit (add **\$276.55** list)

Y New York City (add **\$276.55** list)

C Hardwire

4-Circuit 2+2

2 4-Circuit 2+2 (add **\$307.84** list)

W New York City (add **\$307.84** list)

4-Circuit 3+1

4 4-Circuit 3+1 (add **\$307.84** list)

V New York City (add **\$307.84** list)

2 Raceway Cover Side One

N No Raceway Cover (add **\$180.87** list)

H Raceway Cover with knockouts (not available on 18"(457mm)W, 24"(610mm)W has one set of knockouts on left side)

B Raceway Cover without knockouts

3 Raceway Cover Side Two

N No Raceway Cover (no upcharge)

H Raceway Cover with knockouts (not available on 18"(457mm)W, 24"(610mm)W has one set of knockouts on left side)

B Raceway Cover without knockouts

2) Trim color for pan and raceway covers (if applicable).

3) Trim color for frame.

4) Glass option.

Grade A:
1C = Clear glass

Grade C:
E21 = Satin Etch

Grade D:
1E = Frosted acrylic (M)
VM = Patterned glass
CM = Patterned glass

Note: Upcharge for mixed grade trim surfaces, refer to the electronic design and specification tools for pricing.

(M) Items marked with this symbol available as GSA open market.

Structures

Glass Panels

Nominal Height	Nominal Width	Number	①②③	Trim A Glass			Trim B Glass		
				A	C	D	A	C	D
42"(1067mm)	18"(457mm)	VZGF-4218-NN	■ ■ ■ 1	\$ 1871.44	\$2301.85	\$2759.77	\$1939.28	\$2369.69	\$2827.61
	24"(610mm)	VZGF-4224-N	■ ■ ■ 1	1993.28	2570.52	3211.78	2062.85	2640.09	3281.35
	30"(762mm)	VZGF-4230-N	■ ■ ■ 1	2115.12	2839.19	3663.79	2186.42	2910.49	3735.09
	36"(914mm)	VZGF-4236-N	■ ■ ■ 1	2236.96	3107.86	4115.80	2309.99	3180.89	4188.83
	42"(1067mm)	VZGF-4242-N	■ ■ ■ 1	2358.80	3376.53	4567.81	2433.56	3451.29	4642.57
	48"(1219mm)	VZGF-4248-N	■ ■ ■ 1	2480.64	3645.20	5019.82	2557.13	3721.69	5096.31
	50"(1270mm)	18"(457mm)	VZGF-5018-NN	■ ■ ■ 1	\$ 1934.31	\$2553.40	\$3001.50	\$2010.84	\$2629.93
24"(610mm)		VZGF-5024-N	■ ■ ■ 1	2062.03	2772.18	3541.96	2140.29	2850.44	3620.22
30"(762mm)		VZGF-5030-N	■ ■ ■ 1	2189.75	2990.96	4082.42	2269.74	3070.95	4162.41
36"(914mm)		VZGF-5036-N	■ ■ ■ 1	2317.47	3209.74	4622.88	2399.19	3291.46	4704.60
42"(1067mm)		VZGF-5042-N	■ ■ ■ 1	2445.19	3428.52	5163.34	2528.64	3511.97	5246.79
48"(1219mm)		VZGF-5048-N	■ ■ ■ 1	2572.91	3647.30	5703.80	2658.09	3732.48	5788.98
58"(1473mm)		18"(457mm)	VZGF-5818-NN	■ ■ ■ 1	\$ 1997.18	\$2804.95	\$3243.23	\$2073.71	\$2881.48
	24"(610mm)	VZGF-5824-N	■ ■ ■ 1	2132.77	3074.73	3846.60	2211.03	3152.99	3924.86
	30"(762mm)	VZGF-5830-N	■ ■ ■ 1	2268.36	3344.51	4449.97	2348.35	3424.50	4529.96
	36"(914mm)	VZGF-5836-N	■ ■ ■ 1	2403.95	3614.29	5053.34	2485.67	3696.01	5135.06
	42"(1067mm)	VZGF-5842-N	■ ■ ■ 1	2539.54	3884.07	5656.71	2622.99	3967.52	5740.16
	48"(1219mm)	VZGF-5848-N	■ ■ ■ 1	2675.13	4153.85	6260.08	2760.31	4239.03	6345.26
	66"(1676mm)	18"(457mm)	VZGF-6618-NN	■ ■ ■ 1	\$2060.05	3056.50	3484.96	\$2136.58	3133.03
24"(610mm)		VZGF-6624-N	■ ■ ■ 1	2199.61	3378.74	4104.02	2277.87	3457.00	4182.28
30"(762mm)		VZGF-6630-N	■ ■ ■ 1	2339.17	3700.98	4723.08	2419.16	3780.97	4803.07
36"(914mm)		VZGF-6636-N	■ ■ ■ 1	2478.73	4023.22	5342.14	2560.45	4104.94	5423.86
42"(1067mm)		VZGF-6642-N	■ ■ ■ 1	2618.29	4345.46	5961.20	2701.74	4428.91	6044.65
48"(1219mm)		VZGF-6648-N	■ ■ ■ 1	2757.85	4667.70	6580.26	2843.03	4752.88	6665.44
74"(1880mm)		18"(457mm)	VZGF-7418-NN	■ ■ ■ 1	\$ 2122.92	\$3308.05	\$3726.69	\$2199.45	\$3384.58
	24"(610mm)	VZGF-7424-N	■ ■ ■ 1	2286.05	3687.67	4620.90	2364.31	3765.93	4699.16
	30"(762mm)	VZGF-7430-N	■ ■ ■ 1	2449.18	4067.29	5515.11	2529.17	4147.28	5595.10
	36"(914mm)	VZGF-7436-N	■ ■ ■ 1	2612.31	4446.91	6409.32	2694.03	4528.63	6491.04
	42"(1067mm)	VZGF-7442-N	■ ■ ■ 1	2775.44	4826.53	7303.53	2858.89	4909.98	7386.98
	48"(1219mm)	VZGF-7448-N	■ ■ ■ 1	2938.57	5206.15	8197.74	3023.75	5291.33	8282.92

Structures

Full Panel Frame Foot

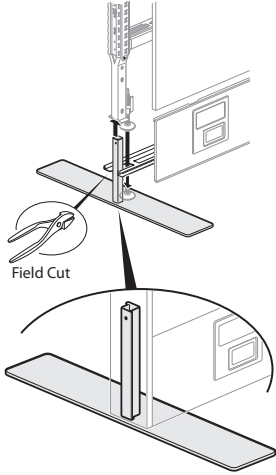

VZLL
Class BC

Features

- Includes foot and attachment hardware.
- Foot mechanism provides 2.5"(64mm) vertical adjustment. Must be set in position at install. Panel glide is positioned on top of foot.

Specification Tips

- Requires field modification to panel frame pan.
- Not for use with panel hung components.
- Not for use with open base.
- Designed to be used in End-of-Run Condition in lieu of a return panel(s).
- Not for use in 2-way, 3-way or 4-way intersections.
- Use for full panel frames with or without screens where the total height of the frame and screen does not exceed 50"(1270mm)H.
- Not for use with Connections or Beam frames.

To Order, Specify:

- 1) Product number.
- 2) Trim color.

Description	Number	Trim	
		A	B
Panel Frame Foot	VZLL-0000-PSF	\$547.95	\$594.60

Structures

Connections Frame

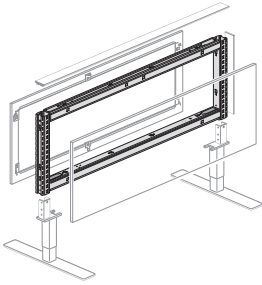

Non Powered Frame

VZFS

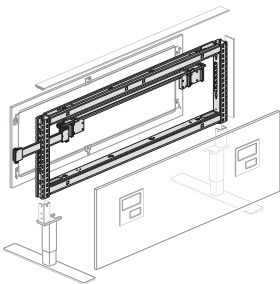

Powered Frame

VZFS

Class BC

Features

- Includes frame, attachment hardware, aligner pin and power distribution assembly/flex connector when power is specified.
- Frame thickness is 2"(51mm). With separately specified tiles on both sides the overall panel thickness is 3"(76mm).
- Powered frames available for countries that utilize 120 volt 60 hertz electrical system and U.S. configured plugs and outlets.
- Black finish on frame.
- Shipped assembled with power when specified.

Specification Tips

- The following items must be separately specified:
 - Tiles (each side specified separately)
 - Top trim
 - End-of-Run trim or 2-, 3-, 4-way trim as needed per application.
 - Frame legs (required)
 - Receptacles for powered panels (each side specified separately)
 - Receptacle blanks/data covers (if applicable)
- Non-Powered Frame:
 - Cannot route power and data horizontally through frame.
 - Not for use with Technology Tile.
- New York City (NYC) electrical requires field installation of PDA.
- Not for use with T-Mount kit.
- Flex connector provided accommodates straight in-line power condition only.
- Connections Frame not intended to accept Stack Kit.
- Do not mix 3-circuit and 6-circuit with 4-circuit components. Do not mix 2+2 and 3+1 components. Components have unique polarity key and color coding (3-circuit=black, 6-circuit=ivory, 2+2=blue and 3+1=green).

To Order, Specify:

1) Product number, including:

1 Below Worksurface Power Option:

U Cutout only

3-Circuit

3 3-Circuit (add \$607.86 list)

Y New York City (add \$607.86 list)

4-Circuit 2+2

2 4-Circuit 2+2 (add \$607.86 list)

W New York City (add \$607.86 list)

4-Circuit 3+1

4 4-Circuit 3+1 (add \$607.86 list)

V New York City (add \$607.86 list)

(No finish specification required.)

Nominal Height	Nominal Width	Number ①	Price
Non-Powered			
16"(406mm)	24"(610mm)	VZFS-1624-R	\$400.49
	30"(762mm)	VZFS-1630-R	438.13
	36"(914mm)	VZFS-1636-R	475.77
	42"(1067mm)	VZFS-1642-R	513.41
	48"(1219mm)	VZFS-1648-R	551.05
	54"(1372mm)	VZFS-1654-R	588.69
	60"(1524mm)	VZFS-1660-R	626.33
	72"(1829mm)	VZFS-1672-R	863.17
Powered			
16"(406mm)	24"(610mm)	VZFS-1624-R ■	\$659.95
	30"(762mm)	VZFS-1630-R ■	697.59
	36"(914mm)	VZFS-1636-R ■	735.23
	42"(1067mm)	VZFS-1642-R ■	772.87
	48"(1219mm)	VZFS-1648-R ■	810.51
	54"(1372mm)	VZFS-1654-R ■	848.15
	60"(1524mm)	VZFS-1660-R ■	885.79
	72"(1829mm)	VZFS-1672-R ■	1122.63

Structures

Connections Frame Leg

In-Line and End-of-Run Condition

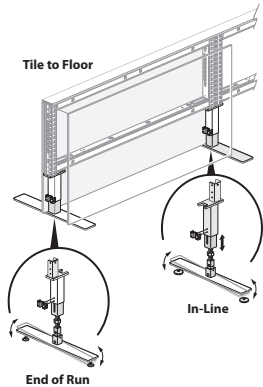
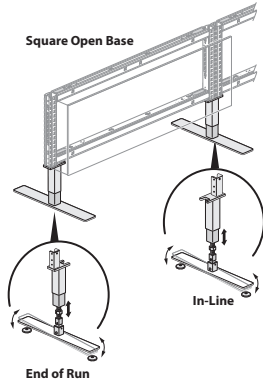

VZLL
Class BC

Features

- Includes leg mechanism, attachment hardware, carpet gripper(s) and if specified, foot and tile-to-floor brackets.
- Square Open Base leg mechanism provides 2.5”(64mm) vertical adjustment.
- Tile-to-Floor leg mechanism provides vertical adjustment of 1.6”(41mm) without foot and 1.4”(36mm) with foot.
- Low profile foot provides angular adjustment for floor leveling.
- Used for End-of-Run and in-line (shared) conditions.

Specification Tips

- A Frame Leg is required at every In-Line and End-of-Run panel condition.
- A foot is required for select product applications. Refer to Support and Load Guidelines for details.
- Not for use in 2-way, 3-way or 4-way intersections.
- Not for use with Compose Full Panel or Beam frames.

To Order, Specify:

1) Product number, including:

1 Foot Option:

N No Foot

F Foot (add **\$65.32** list)

2 Tile Option:

N Square Open Base

T Tile-to-Floor (add **\$130.65** list)

2) Trim color.

Height	Number	Trim	
		A	B
8”(203mm)	VZLL-0800-PS	\$1123.43	\$1170.08

Structures

Connections Frame Leg

2-, 3-, 4-Way Intersection

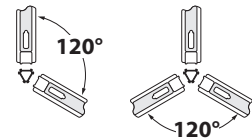
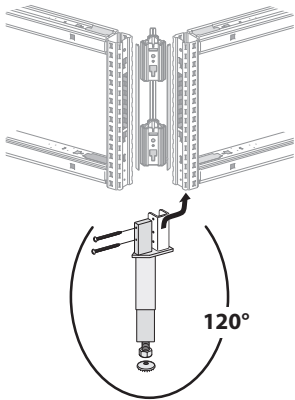
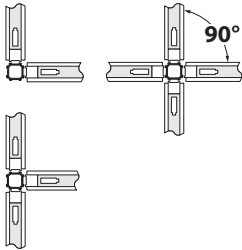
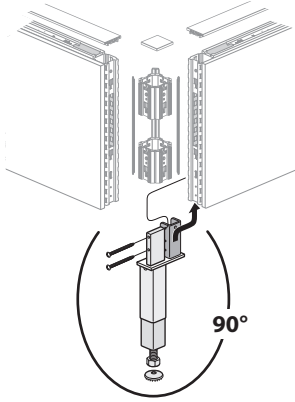

VZLL
Class BC

Features

- Includes Leg mechanism, attachment hardware and carpet gripper(s).
- Square Open Base leg mechanism provides 2.5"(64mm) vertical adjustment.

Specification Tips

- Not for use with Tile-to-Floor.
- 90° Frame Leg works in 90° 2-way, 3-way and 4-way intersections.
- 120° Frame Leg works in 120° 2-way and 3-way intersections.
- One frame leg is required for each panel intersection.
- Not for use in an In-Line or End-of-Run panel condition.
- Not for use with Compose Full Panel or Beam frames.

To Order, Specify:

- 1) Product number.
- 2) Trim color.

Description	Height	Number	Trim	
			A	B
90°	8"(203mm)	VZLL-0800-PCNN	\$1577.59	\$1624.24
120°	8"(203mm)	VZLL-0800-PZNN	1577.59	1624.24

Structures

Beam Frame

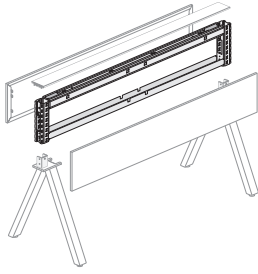

Non Powered Frame

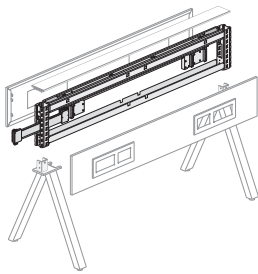

Powered Frame
VZFJ
Class BC

Features

- Includes frame, attachment hardware, aligner pin and power distribution assembly/flex connector when power is specified.
- Frame thickness is 2"(51mm). With separately specified tiles on both sides the overall thickness is 3"(76mm).
- Powered frames available for countries that utilize 120 volt 60 hertz electrical system and U.S. configured plugs and outlets.
- Black finish on frame.
- Shipped assembled with power when specified.

Specification Tips

- **Does not attach to Compose Full Panel or Connections.**
- Not for use with Stack Frame or Glass Stack.
- Frames require a leg at every in-line, end of run condition and every 90° 2-, 3-, 4- way intersection.
- Not for use with T-Mount kit.
- The following items must be separately specified:
 - 8"(203mm)H tiles (each side specified separately).
 - Top Trim
 - End-of-Run trim or 2-, 3-, 4-Way trim as needed per application.
 - Legs (every in-line, end of run condition and 90° 2-, 3-, 4- way intersection).
 - Receptacles for powered frame (each side specified separately)
 - Receptacle blanks/data covers (each side specified separately)
 - Communication Data Bracket
- Flex connector provided accommodates straight in-line power condition, only.
- 18"(457mm)-24"(610mm)W Frame:
 - Non-powered only.
 - Standard with cutout only and no receptacle locations.
 - May not be field retrofitted with power.
 - To continue power through frame use Extended Power Connector; separately specified.
- 30"(762mm)-72"(1829mm)W Frame:
 - Available with 3- or 4-circuit power or non-powered with cutout only.
 - May be field retrofitted for power using Raceway Retrofit Kit; separately specified.
 - Hardwire power available; separately specified.
- New York City (NYC) electrical - requires field installation of PDA.
- Do not mix 3-circuit and 6-circuit with 4-circuit components. Do not mix 2+2 and 3+1 components. Components have unique polarity key and color coding (3-circuit=black, 6-circuit=ivory, 2+2=blue and 3+1=green).

To Order, Specify:

1) Product number, including:

1 Below Worksurface Power Options:

U Cutout only

3-Circuit

3 3-Circuit (add \$197.56 list)

Y New York City (add \$197.56 list)

4-Circuit, 2+2

2 4-Circuit 2+2 (add \$197.56 list)

W New York City (add \$197.56 list)

4-Circuit, 3+1

4 4-Circuit 3+1 (add \$197.56 list)

V New York City (add \$197.56 list)

(No finish specification required.)

Note: Receptacles, blank covers and Communication Data Bracket are for use with a Technology Tile; below worksurface power access only.

Nominal Height	Nominal Width	Number ①	Price
8"(203mm)	18"(457mm)	VZFJ-0818-RU	\$349.33
	24"(610mm)	VZFJ-0824-RU	376.14
	30"(762mm)	VZFJ-0830-R ■	402.95
	36"(914mm)	VZFJ-0836-R ■	429.76
	42"(1067mm)	VZFJ-0842-R ■	456.57
	48"(1219mm)	VZFJ-0848-R ■	483.38
	54"(1372mm)	VZFJ-0854-R ■	510.19
	60"(1524mm)	VZFJ-0860-R ■	537.00
	72"(1829mm)	VZFJ-0872-R ■	590.62

Structures

Beam Frame Leg

Straight Leg with Foot — In-Line and End-of-Run Condition

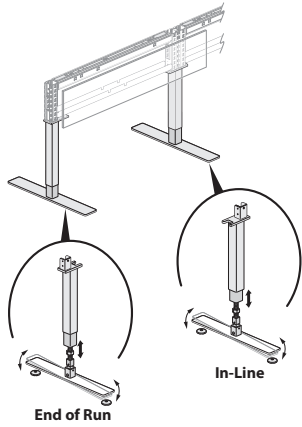

VZLL
Class BC

Features

- Includes leg mechanism, attachment hardware, carpet gripper.
- Provides 2.5"(64mm) inches of height adjustment. Must be set in position at install.
- Independent glide adjustment adapts to uneven floor conditions.
- Foot provides angular adjustment for floor leveling.

Specification Tips

- Only for use with beam frame in-line or end-of-run conditions.
- A straight run of beam frames require a straight leg with foot or an A-Leg at every in-line and end-of-run condition.
- Not for use in 2-, 3-, or 4-way intersections.
- For beam frame applications with no foot requirement refer to the Specification Guide - Support and Load section.
- Straight leg is the recommended leg style when freestanding storage is located parallel to beam frames.
- Straight leg is the recommended leg style when freestanding storage or a freestanding table is located next to beam frames.

To Order, Specify:

- 1) Product number, including:
 - 1 **Foot Option:**
 - N** No Foot
 - F** Foot (add **\$65.32** list)
- 2) Trim color.

Height	Number ①	Trim A	B
16"(406mm)	VZLL-1600-PS N	\$1123.43	\$1170.08

Straight Leg — 2-, 3-, 4-Way Intersection

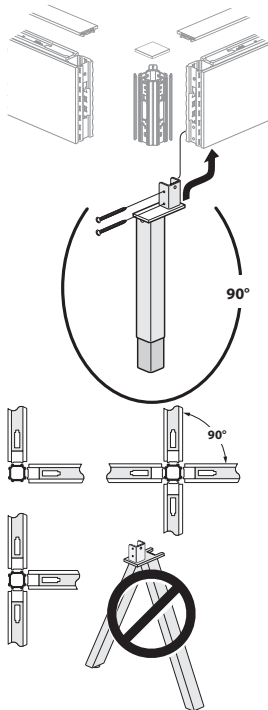

VZLL-PCNN
Class BC

Features

- Includes Leg mechanism, attachment hardware and carpet gripper(s).
- Leg mechanism provides 2.5"(64mm) vertical adjustment.

Specification Tips

- For use in 90° 2-way, 3-way and 4-way beam frame intersections, only.
- One leg is required for each 90° 2-, 3-, 4-Way intersection.
- Must be used in all corner applications regardless if the in-line leg is the straight adjustable leg or the A-Leg.

To Order, Specify:

- 1) Product number.
- 2) Trim color.

Description	Height	Number	Trim A	B
90°	16"(406mm)	VZLL-1600-PCNN	\$1577.59	\$1624.24

Structures

Beam Frame Leg

A Leg — In-Line and End-of-Run Condition

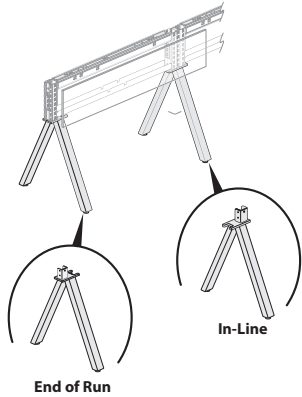

VZLA-PSN
Class BC

Features

- Includes leg with glides and attachment hardware.
- Independent glide adjustment adapts to uneven floor conditions.
- Glides have 0.5"(13mm) adjustment and standard in black.

Specification Tips

- For use with beam frame in-line or end-of-run conditions, only.
- Not for use in 2-, 3-, or 4-way intersections.
- A straight run of beam frames require an A leg or a straight leg with foot at every in-line and end-of-run condition.
- A Leg is not recommended for applications with freestanding storage or freestanding tables located next to beam frames; use straight leg for this application.
- Angled A Leg protrudes 7"(178mm) from beam frame which creates a gap between most parallel freestanding furnishings and beam frame.

To Order, Specify:

- 1) Product number.
- 2) Trim color.

Height	Number	Trim	
		A	B
16"(406mm)	VZLA-1600-PSN	\$1210.19	\$1231.55

High Acoustical Inserts

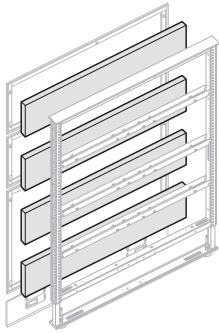

VZFI-A
Class BC

Features

- Converts fabric acoustical tiles from standard to high acoustical.
- Includes acoustical insert(s) to fit within panel or stack frame.

Specification Tips

- 8"(203mm)H tiles may not be installed in raceway position in lieu of base raceway cover.
- High acoustical inserts cannot be installed at power locations.
- 8"(203mm) and 16"(406mm)H inserts convert one section of panel frame.
- 34"(864mm)-74"(1880mm)H inserts convert entire panel frame.
- For NRC/STC ratings, refer to Specification Guide.

To Order, Specify:

- 1) Product number.
(No finish specification required.)

Nominal Height	Quantity-Height	Nominal Width	Number	Price
8"(203mm)	One 8"(203mm)	18"(457mm)	VZFI-0818-A	\$ 33.03
		24"(610mm)	VZFI-0824-A	36.32
		30"(762mm)	VZFI-0830-A	39.60
		36"(914mm)	VZFI-0836-A	42.89
		42"(1067mm)	VZFI-0842-A	46.17
		48"(1219mm)	VZFI-0848-A	49.46
		54"(1372mm)	VZFI-0854-A	73.28
		60"(1524mm)	VZFI-0860-A	76.57
		72"(1829mm)	VZFI-0872-A	78.07
16"(406mm)	One 16"(406mm)	18"(457mm)	VZFI-1618-A	\$ 42.89
		24"(610mm)	VZFI-1624-A	49.46
		30"(762mm)	VZFI-1630-A	56.03
		36"(914mm)	VZFI-1636-A	62.59
		42"(1067mm)	VZFI-1642-A	69.16
		48"(1219mm)	VZFI-1648-A	75.74
		54"(1372mm)	VZFI-1654-A	102.84
		60"(1524mm)	VZFI-1660-A	109.41
		72"(1829mm)	VZFI-1672-A	156.89
34"(864mm)	One 8"(203mm), One 16"(406mm)	18"(457mm)	VZFI-3418-A	\$ 65.06
		24"(610mm)	VZFI-3424-A	79.02
		30"(762mm)	VZFI-3430-A	92.98
		36"(914mm)	VZFI-3436-A	106.94
		42"(1067mm)	VZFI-3442-A	120.90
		48"(1219mm)	VZFI-3448-A	134.87
		54"(1372mm)	VZFI-3454-A	169.37
		60"(1524mm)	VZFI-3460-A	183.33
		72"(1829mm)	VZFI-3472-A	334.24
42"(1067mm)	Two 16"(406mm)	18"(457mm)	VZFI-4218-A	\$ 74.91
		24"(610mm)	VZFI-4224-A	92.16
		30"(762mm)	VZFI-4230-A	109.41
		36"(914mm)	VZFI-4236-A	126.65
		42"(1067mm)	VZFI-4242-A	143.90
		48"(1219mm)	VZFI-4248-A	161.15
		54"(1372mm)	VZFI-4254-A	198.93
		60"(1524mm)	VZFI-4260-A	216.18
		72"(1829mm)	VZFI-4272-A	413.06

High Acoustical Inserts

Nominal Height	Quantity-Height	Nominal Width	Number	Price
50"(1270mm)	One 8"(203mm), Two 16"(406mm)	18"(457mm)	VZFI-5018-A	\$ 84.77
		24"(610mm)	VZFI-5024-A	105.30
		30"(762mm)	VZFI-5030-A	125.83
		36"(914mm)	VZFI-5036-A	146.36
		42"(1067mm)	VZFI-5042-A	166.89
		48"(1219mm)	VZFI-5048-A	187.43
		54"(1372mm)	VZFI-5054-A	228.50
		60"(1524mm)	VZFI-5060-A	249.03
		72"(1829mm)	VZFI-5072-A	491.88
58"(1473mm)	Three 16"(406mm)	18"(457mm)	VZFI-5818-A	\$ 94.62
		24"(610mm)	VZFI-5824-A	118.44
		30"(762mm)	VZFI-5830-A	142.26
		36"(914mm)	VZFI-5836-A	166.07
		42"(1067mm)	VZFI-5842-A	189.89
		48"(1219mm)	VZFI-5848-A	213.71
		54"(1372mm)	VZFI-5854-A	258.06
		60"(1524mm)	VZFI-5860-A	281.88
		72"(1829mm)	VZFI-5872-A	570.70
66"(1676mm)	One 8"(203mm), Three 16"(406mm)	18"(457mm)	VZFI-6618-A	\$ 104.48
		24"(610mm)	VZFI-6624-A	131.58
		30"(762mm)	VZFI-6630-A	158.68
		36"(914mm)	VZFI-6636-A	185.78
		42"(1067mm)	VZFI-6642-A	212.88
		48"(1219mm)	VZFI-6648-A	239.99
		54"(1372mm)	VZFI-6654-A	287.63
		60"(1524mm)	VZFI-6660-A	314.73
		72"(1829mm)	VZFI-6672-A	649.52
74"(1880mm)	Four 16"(406mm)	18"(457mm)	VZFI-7418-A	\$ 114.33
		24"(610mm)	VZFI-7424-A	144.72
		30"(762mm)	VZFI-7430-A	175.11
		36"(914mm)	VZFI-7436-A	205.49
		42"(1067mm)	VZFI-7442-A	235.88
		48"(1219mm)	VZFI-7448-A	266.26
		54"(1372mm)	VZFI-7454-A	317.19
		60"(1524mm)	VZFI-7460-A	347.58
		72"(1829mm)	VZFI-7472-A	728.34

Tiles - Full Panel, Connections and Stack Frame

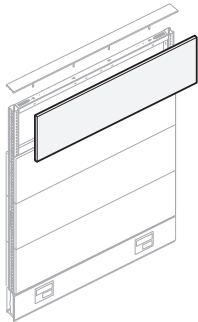

VZTI-DNN

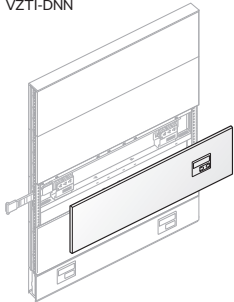

VZTI-DRN

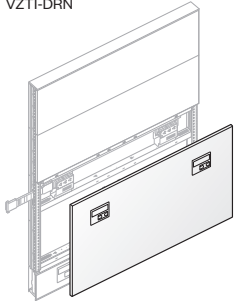

VZTI-D2N

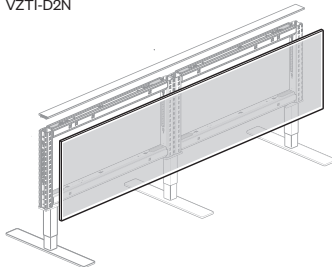

VZTI-DNS

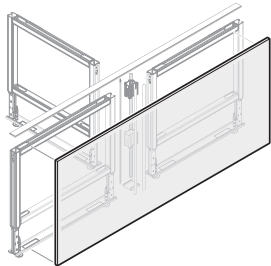

VZTI-DNS
Class BC

Common Features

- Includes one tile, attachment brackets and utility bezel(s) if applicable.
- Actual height is nominal height less .130" (3mm).
- Actual width is nominal width less .400" (10mm)
- Aligner/Light Blocks are required and separately specified based upon tile configuration; refer to Specification Guide.
- Tile type and height may be same or different on each side of frame.
- Tile may be located above the base raceway or Tile-to-Floor option may be specified to hide or cover the base raceway.

• Numerous tile combinations are allowed based on desired function and aesthetic. To determine vertical face dimensions:

–Full panel frame, non-raceway cover:
frame height -2" (51mm)=vertical face available for individual tile height(s).

–Full panel frame, raceway cover:
frame height -10" (254mm)=vertical face available for individual tile height(s).

–Individual tiles (face dimension) must be divisible by 8 to fill panel frame (vertical face available).

• Technology Tiles (Fabric, Laminate, Steel, Wood, Slat):

–For use with 3- or 4-circuit powered frame.

–18" (457mm)W tile not available with technology access.

–24" (610mm)W tiles available with single (left or right hand) technology access only.

–Technology Tiles may NOT span frames.

–The following power and communication items must be separately specified:

- 3- or 4-circuit receptacle or receptacle blank cover (each side specified separately).
 - Data faceplate (field supplied) or data blank cover (VZAD-0000-R).
- Tiles must be placed at appropriate height to align with power access location.
- Tile-to-floor with base raceway technology access is available in fabric only.

–Power can be routed horizontally at raceway, beltline and below worksurface locations. Routing power at below worksurface height requires it to be specified with a panel frame with below worksurface power and cutout

–A left-hand and right-hand Technology Tile may be specified for a back-to-back technology access application.

• Tile-to-Floor Application (Fabric, Laminate, Steel, Wood, Markerboard, Slat):

–8" (203mm)H tile may not be used in the bottom position.

–Concealed Base Feed may be used with Tile-to-Floor with Base Raceway Technology Access. When applied in front of a Concealed Base Feed, Tiles must be sized and applied in a way that allows easy removal for access to base feed. A receptacle location will be taken up by the Concealed Base Feed when in use.

• In-Line Spanning Tile (Fabric, Laminate, Steel, Wood):

–Tiles 36" (914mm)W and greater without technology access may span a maximum of two horizontally adjacent frames.

–Technology Access Tiles may NOT span frames.

–Opposite side of spanning tile may be same width as each frame or another spanning tile.

–Center attachment clips will require field relocation.

• 3-Way Intersection Spanning Tile (Fabric, Laminate, Steel, Wood):

–The width equals the sum of two separately specified panel or stack frames plus 3" (76mm) for 3-Way panel intersection

–Opposite side of frames require separately specified tiles.

–Separately specified 3-Way Intersection - Spanning Tile Corner Blocks (VZCT-____-NS) are required.

–Separately specified spanning top trim is required; not for use with to trim same width as individual frames.

Order Specification

1) Product number, including:

1 Technology Port Option:

N No Technology Access

L Left-Hand Port

R Right-Hand Port

2 Left and Right-Hand Port

2) Surface color/finish.

3) Bezel trim color (if applicable).

TR-R Beige

TR-AK Chalk

TR-K Charcoal

TR-J Graphite

TR-G Gray Tone

TR-TW Plaster

TR-AA Putty

TR-E Smoke

Tiles - Full Panel, Connections and Stack Frame

Fabric

Unique Features

- Fabric Tiles are tackable and provide acoustical value.
- High Acoustic option available; specified separately.
- **Tiles greater than 60"(1524mm)W, fabric will be railroded (RR). Please refer to surfaces.haworth.com for available fabric and codes.**
- For aesthetic reasons, consider specifying tiles 60"(1524mm)W or less with railroded fabric if located adjacent to a tile which requires railroded fabric.

To Order, Specify:

- Product number, including:
 - 1 Technology Port Option:**
 - N** No Technology Access
 - L** Left-Hand Port (add **\$88.70** list)
 - R** Right-Hand Port (add **\$88.70** list)
 - 2** Left and Right-Hand Port (add **\$212.90** list)
- Fabric color.
- Trim color for bezel (if applicable).

Note: 72"(1829mm)W is not available in 64"(1626mm) and 72"(1829mm) tile height.

Nominal Height	Nominal Width	Number ①	Fabric						
			A	B	C	D	E	F	G
Individual and In-Line Spanning Tiles									
8"(203mm)	18"(457mm)	VZTI-0818-FNN	\$ 91.43	\$ 104.50	\$ 118.85	\$ 134.52	\$ 150.20	\$ 171.09	\$ 184.17
	24"(610mm)	VZTI-0824-FNN	98.45	112.58	128.11	145.06	162.03	184.62	198.76
	30"(762mm)	VZTI-0830-FNN	105.45	120.66	137.35	155.60	173.85	198.14	213.34
	36"(914mm)	VZTI-0836-FNN	117.46	133.74	151.61	171.13	190.68	216.67	232.92
	42"(1067mm)	VZTI-0842-FNN	119.48	136.81	155.86	176.67	197.50	225.20	242.51
	48"(1219mm)	VZTI-0848-FNN	126.48	144.90	165.11	187.21	209.32	238.72	257.10
	54"(1372mm)	VZTI-0854-FNN	133.50	152.97	174.36	197.75	221.15	252.25	271.68
	60"(1524mm)	VZTI-0860-FNN	140.51	161.04	183.61	208.28	232.97	265.78	286.26
	66"(1676mm)	VZTI-0866-FNS	197.52	219.13	242.86	268.83	294.80	329.30	350.85
	72"(1829mm)	VZTI-0872-FNN	206.36	229.03	253.94	281.19	308.45	344.66	367.26
16"(406mm)	18"(457mm)	VZTI-1618-FNN	\$ 121.47	\$ 139.12	\$ 158.50	\$ 179.66	\$200.84	\$229.02	\$ 246.66
	24"(610mm)	VZTI-1624-F N	133.73	153.25	174.68	198.09	221.51	252.66	272.16
	30"(762mm)	VZTI-1630-F N	145.99	167.36	190.86	216.50	242.17	276.31	297.65
	36"(914mm)	VZTI-1636-F N	163.24	186.49	212.04	239.92	267.84	304.95	328.14
	42"(1067mm)	VZTI-1642-F N	170.50	195.61	223.21	253.35	283.50	323.59	348.64
	48"(1219mm)	VZTI-1648-F N	182.76	209.73	239.40	271.76	304.16	347.24	374.14
	54"(1372mm)	VZTI-1654-F N	195.02	223.85	255.57	290.19	324.83	370.88	399.63
	60"(1524mm)	VZTI-1660-F N	207.27	237.97	271.74	308.61	345.49	394.52	425.12
	66"(1676mm)	VZTI-1666-F S	269.54	302.09	337.93	377.03	416.16	468.17	500.62
	72"(1829mm)	VZTI-1672-F N	291.25	325.67	363.56	404.91	446.28	501.27	535.57
24"(610mm)	18"(457mm)	VZTI-2418-FNN	\$ 151.51	\$ 173.74	\$ 198.15	\$224.80	\$ 251.48	\$286.95	\$ 309.15
	24"(610mm)	VZTI-2424-F N	169.02	193.91	221.26	251.11	280.99	320.71	345.56
	30"(762mm)	VZTI-2430-F N	186.52	214.07	244.36	277.41	310.49	354.47	381.96
	36"(914mm)	VZTI-2436-F N	209.02	239.24	272.47	308.71	345.00	393.23	423.36
	42"(1067mm)	VZTI-2442-F N	221.53	254.40	290.57	330.02	369.50	421.99	454.77
	48"(1219mm)	VZTI-2448-F N	239.03	274.57	313.68	356.32	399.00	455.75	491.18
	54"(1372mm)	VZTI-2454-F N	256.54	294.73	336.78	382.63	428.51	489.51	527.58
	60"(1524mm)	VZTI-2460-F N	274.04	314.89	359.88	408.93	458.01	523.27	563.98
	66"(1676mm)	VZTI-2466-F S	341.55	385.06	432.99	485.24	537.52	607.03	650.39
	72"(1829mm)	VZTI-2472-F N	376.14	422.31	473.18	528.63	584.11	657.88	703.88
32"(813mm)	18"(457mm)	VZTI-3218-FNN	\$ 181.55	\$208.36	\$ 237.80	\$269.94	\$ 302.12	\$344.88	\$ 371.64
	24"(610mm)	VZTI-3224-F N	204.31	234.57	267.84	304.13	340.47	388.76	418.96
	30"(762mm)	VZTI-3230-F N	227.05	260.78	297.86	338.32	378.81	432.63	466.27
	36"(914mm)	VZTI-3236-F N	254.80	291.99	332.90	377.50	422.16	481.51	518.58
	42"(1067mm)	VZTI-3242-F N	272.56	313.19	357.93	406.69	455.50	520.39	560.90
	48"(1219mm)	VZTI-3248-F N	295.30	339.41	387.96	440.88	493.84	564.26	608.22
	54"(1372mm)	VZTI-3254-F N	318.06	365.61	417.99	475.07	532.19	608.14	655.53
	60"(1524mm)	VZTI-3260-F N	340.81	391.81	448.02	509.25	570.53	652.02	702.84
	66"(1676mm)	VZTI-3266-F S	413.56	468.03	528.05	593.45	658.88	745.89	800.16
	72"(1829mm)	VZTI-3272-F N	461.03	518.95	582.80	652.35	721.94	814.49	872.19

Tiles - Full Panel, Connections and Stack Frame

Nominal Height	Nominal Width	Fabric Number	Fabric						
			A	B	C	D	E	F	G
40"(1016mm)	18"(457mm)	VZTI-4018-FNN	\$ 226.59	\$ 257.98	\$ 292.45	\$ 330.08	\$ 367.76	\$ 417.81	\$ 449.13
	24"(610mm)	VZTI-4024-FNN	254.59	290.24	329.41	372.16	414.95	471.80	507.36
	30"(762mm)	VZTI-4030-FNN	282.59	322.48	366.37	414.22	462.13	525.80	565.58
	36"(914mm)	VZTI-4036-FNN	315.58	359.74	408.33	461.29	514.32	584.79	628.80
	42"(1067mm)	VZTI-4042-FNN	338.58	386.99	440.28	498.37	556.50	633.78	682.03
	48"(1219mm)	VZTI-4048-FNN	366.58	419.24	477.25	540.43	603.68	687.78	740.26
	54"(1372mm)	VZTI-4054-FNN	394.58	451.49	514.20	582.51	650.87	741.77	798.48
	60"(1524mm)	VZTI-4060-FNN	422.57	483.74	551.15	624.58	698.05	795.76	856.70
	66"(1676mm)	VZTI-4066-FNS	500.58	565.99	638.12	716.65	795.24	899.76	964.93
72"(1829mm)	VZTI-4072-FNN	560.92	630.59	707.42	791.07	874.77	986.10	1055.50	
48"(1219mm)	18"(457mm)	VZTI-4818-FNN	\$ 241.63	\$ 277.60	\$ 317.10	\$ 360.22	\$ 403.40	\$ 460.74	\$ 496.62
	24"(610mm)	VZTI-4824-FNN	274.88	315.90	360.99	410.18	459.43	524.85	565.76
	30"(762mm)	VZTI-4830-FNN	308.12	354.19	404.87	460.13	515.45	588.96	634.89
	36"(914mm)	VZTI-4836-FNC	346.36	397.49	453.76	515.08	576.48	658.07	709.02
	42"(1067mm)	VZTI-4842-FNC	374.61	430.78	492.64	560.04	627.50	717.18	773.16
	48"(1219mm)	VZTI-4848-FNC	407.85	469.08	536.53	609.99	683.52	781.29	842.30
	54"(1372mm)	VZTI-4854-FNC	441.10	507.37	580.41	659.95	739.55	845.40	911.43
	60"(1524mm)	VZTI-4860-FNC	474.34	545.66	624.29	709.90	795.57	909.51	980.56
	66"(1676mm)	VZTI-4866-FNS	557.59	633.96	718.18	809.86	901.60	1023.62	1099.70
72"(1829mm)	VZTI-4872-FNC	630.81	712.23	802.04	899.79	997.60	1127.71	1208.81	
56"(1422mm)	18"(457mm)	VZTI-5618-FNN	\$ 271.67	\$ 312.22	\$ 356.75	\$ 405.36	\$ 454.04	\$ 518.67	\$ 559.11
	24"(610mm)	VZTI-5624-FNN	310.17	356.56	407.57	463.20	518.91	592.90	639.16
	30"(762mm)	VZTI-5630-FNN	348.65	400.90	458.37	521.04	583.77	667.12	719.20
	36"(914mm)	VZTI-5636-FNC	392.14	450.24	514.19	583.87	653.64	746.35	804.24
	42"(1067mm)	VZTI-5642-FNC	425.64	489.57	560.00	636.71	713.50	815.58	879.29
	48"(1219mm)	VZTI-5648-FNC	464.12	533.92	610.81	694.55	778.36	889.80	959.34
	54"(1372mm)	VZTI-5654-FNC	502.62	578.25	661.62	752.39	843.23	964.03	1039.38
	60"(1524mm)	VZTI-5660-FNC	541.11	622.58	712.43	810.22	908.09	1038.26	1119.42
	66"(1676mm)	VZTI-5666-FNS	629.60	716.93	813.24	918.07	1022.96	1162.48	1249.47
72"(1829mm)	VZTI-5672-FNC	715.70	808.87	911.66	1023.51	1135.43	1284.32	1377.12	
64"(1626mm)	18"(457mm)	VZTI-6418-FNN	\$ 301.71	\$ 346.84	\$ 396.40	\$ 450.50	\$ 504.68	\$ 576.60	\$ 621.60
	24"(610mm)	VZTI-6424-FNN	345.45	397.23	454.14	516.23	578.39	660.94	712.56
	30"(762mm)	VZTI-6430-FNN	389.19	447.60	511.88	581.94	652.09	745.29	803.51
	36"(914mm)	VZTI-6436-FNC	437.92	502.99	574.62	652.66	730.80	834.63	899.46
	42"(1067mm)	VZTI-6442-FNC	476.66	548.37	627.35	713.39	799.50	913.97	985.42
	48"(1219mm)	VZTI-6448-FNC	520.40	598.75	685.10	779.10	873.20	998.32	1076.38
	54"(1372mm)	VZTI-6454-FNC	564.14	649.13	742.83	844.83	946.91	1082.66	1167.33
	60"(1524mm)	VZTI-6460-FNC	607.87	699.51	800.56	910.55	1020.61	1167.00	1258.28
	72"(1829mm)	VZTI-6472-FNC	700.51	802.15	911.66	1029.51	1147.43	1304.32	1400.28
72"(1829mm)	18"(457mm)	VZTI-7218-FNN	\$ 406.75	\$ 456.46	\$ 511.05	\$ 570.64	\$ 630.32	\$ 709.53	\$ 759.09
	24"(610mm)	VZTI-7224-FNN	455.74	512.89	575.72	644.25	712.87	803.99	860.96
	30"(762mm)	VZTI-7230-FNN	504.72	569.31	640.38	717.85	795.41	898.45	962.82
	36"(914mm)	VZTI-7236-FNC	558.70	630.74	710.05	796.45	882.96	997.91	1069.68
	42"(1067mm)	VZTI-7242-FNC	602.69	682.16	769.71	865.06	960.50	1087.37	1166.55
	48"(1219mm)	VZTI-7248-FNC	651.67	738.59	834.38	938.66	1043.04	1181.83	1268.42
	54"(1372mm)	VZTI-7254-FNC	700.66	795.01	899.04	1012.27	1125.59	1276.29	1370.28
	60"(1524mm)	VZTI-7260-FNC	749.64	851.43	963.70	1085.87	1208.13	1370.75	1472.14
	72"(1829mm)	VZTI-7272-FNC	800.51	912.15	1031.66	1164.51	1302.43	1460.32	1534.28

Tiles - Full Panel, Connections and Stack Frame

Nominal Height	Nominal Width	Fabric Number	Fabric						
			A	B	C	D	E	F	G
Spanning 3-Way Intersection Tiles									
8"(203mm)	39"(991mm)	VZTI-0839-FNS	\$ 330.58	\$ 347.38	\$ 365.84	\$ 386.01	\$ 406.20	\$ 433.05	\$ 449.82
	45"(1143mm)	VZTI-0845-FNS	337.59	355.46	375.09	396.55	418.02	446.56	464.41
	51"(1295mm)	VZTI-0851-FNS	344.61	363.54	384.35	407.09	429.85	460.10	479.00
	57"(1448mm)	VZTI-0857-FNS	351.61	371.62	393.59	417.63	441.67	473.62	493.58
	63"(1600mm)	VZTI-0863-FNS	358.63	379.69	402.85	428.17	453.50	487.16	508.16
	69"(1753mm)	VZTI-0869-FNS	365.64	387.78	412.10	438.71	465.32	500.67	522.75
16"(406mm)	39"(991mm)	VZTI-1639-FNS	\$ 378.99	\$ 403.15	\$ 429.74	\$ 458.74	\$ 487.78	\$ 526.39	\$ 550.50
	45"(1143mm)	VZTI-1645-FNS	391.24	417.28	445.91	477.17	508.44	550.02	576.00
	51"(1295mm)	VZTI-1651-FNS	403.50	431.40	462.09	495.59	529.11	573.67	601.49
	57"(1448mm)	VZTI-1657-FNS	415.76	445.52	478.27	514.01	549.77	597.31	626.99
	63"(1600mm)	VZTI-1663-FNS	428.02	459.64	494.45	532.43	570.44	620.96	652.48
	69"(1753mm)	VZTI-1669-FNS	440.27	473.77	510.62	550.86	591.10	644.59	677.98
24"(610mm)	39"(991mm)	VZTI-2439-FNS	\$ 427.39	\$ 458.92	\$ 493.63	\$ 531.47	\$ 569.36	\$ 619.73	\$ 651.17
	45"(1143mm)	VZTI-2445-FNS	444.89	479.09	516.73	557.78	598.86	653.47	687.58
	51"(1295mm)	VZTI-2451-FNS	462.40	499.25	539.84	584.09	628.37	687.25	723.98
	57"(1448mm)	VZTI-2457-FNS	479.90	519.42	562.94	610.39	657.87	720.99	760.39
	63"(1600mm)	VZTI-2463-FNS	497.41	539.58	586.05	636.69	687.38	754.76	796.79
	69"(1753mm)	VZTI-2469-FNS	514.91	559.75	609.15	663.00	716.88	788.51	833.20
32"(813mm)	39"(991mm)	VZTI-3239-FNS	\$ 475.79	\$ 514.70	\$ 557.52	\$ 604.21	\$ 650.94	\$ 713.06	\$ 751.85
	45"(1143mm)	VZTI-3245-FNS	498.54	540.91	587.55	638.40	689.28	756.93	799.17
	51"(1295mm)	VZTI-3251-FNS	521.30	567.11	617.59	672.58	727.63	800.82	846.48
	57"(1448mm)	VZTI-3257-FNS	544.04	593.33	647.61	706.78	765.97	844.68	893.80
	63"(1600mm)	VZTI-3263-FNS	566.80	619.53	677.65	740.96	804.32	888.57	941.11
	69"(1753mm)	VZTI-3269-FNS	589.55	645.74	707.68	775.15	842.66	932.44	988.43
40"(1016mm)	39"(991mm)	VZTI-4039-FNS	\$ 539.20	\$ 585.47	\$ 636.42	\$ 691.94	\$ 747.52	\$ 821.40	\$ 867.52
	45"(1143mm)	VZTI-4045-FNS	567.19	617.72	673.37	734.01	794.70	875.38	925.75
	51"(1295mm)	VZTI-4051-FNS	595.19	649.97	710.33	776.08	841.89	929.39	983.97
	57"(1448mm)	VZTI-4057-FNS	623.19	682.23	747.29	818.16	889.07	983.37	1042.20
	63"(1600mm)	VZTI-4063-FNS	651.19	714.47	784.25	860.22	936.26	1037.37	1100.42
	69"(1753mm)	VZTI-4069-FNS	679.18	746.73	821.20	902.30	983.44	1091.36	1158.65
48"(1219mm)	39"(991mm)	VZTI-4839-FNS	\$ 572.60	\$ 626.24	\$ 685.31	\$ 749.67	\$ 814.10	\$ 899.74	\$ 953.20
	45"(1143mm)	VZTI-4845-FNS	605.84	664.54	729.19	799.63	870.12	963.84	1022.34
	51"(1295mm)	VZTI-4851-FNS	639.09	702.83	773.08	849.58	926.15	1027.96	1091.47
	57"(1448mm)	VZTI-4857-FNS	672.33	741.13	816.96	899.54	982.17	1092.06	1160.61
	63"(1600mm)	VZTI-4863-FNS	705.58	779.42	860.85	949.49	1038.20	1156.18	1229.74
	69"(1753mm)	VZTI-4869-FNS	738.82	817.72	904.73	999.45	1094.22	1220.28	1298.88
56"(1422mm)	39"(991mm)	VZTI-5639-FNS	\$ 621.00	\$ 682.01	\$ 749.20	\$ 822.40	\$ 895.68	\$ 993.08	\$ 1053.87
	45"(1143mm)	VZTI-5645-FNS	659.49	726.35	800.01	880.24	960.54	1067.30	1133.92
	51"(1295mm)	VZTI-5651-FNS	697.99	770.69	850.83	938.08	1025.41	1141.53	1213.96
	57"(1448mm)	VZTI-5657-FNS	736.47	815.03	901.63	995.92	1090.27	1215.75	1294.01
	63"(1600mm)	VZTI-5663-FNS	774.97	859.36	952.45	1053.75	1155.14	1289.98	1374.05
	69"(1753mm)	VZTI-5669-FNS	813.46	903.71	1003.26	1111.60	1220.00	1364.20	1454.10
64"(1626mm)	39"(991mm)	VZTI-6439-FNS	\$ 669.41	\$ 737.78	\$ 813.10	\$ 895.13	\$ 977.26	\$ 1086.42	\$ 1154.55
	45"(1143mm)	VZTI-6445-FNS	713.14	788.17	870.83	960.86	1050.96	1170.75	1245.51
	51"(1295mm)	VZTI-6451-FNS	756.88	838.55	928.57	1026.58	1124.67	1255.10	1336.46
	57"(1448mm)	VZTI-6457-FNS	800.62	888.93	986.31	1092.30	1198.37	1339.44	1427.42
72"(1829mm)	39"(991mm)	VZTI-7239-FNS	\$ 792.81	\$ 868.55	\$ 951.99	\$ 1042.86	\$ 1133.84	\$ 1254.76	\$ 1330.23
	45"(1143mm)	VZTI-7245-FNS	841.79	924.98	1016.65	1116.47	1216.38	1349.20	1432.09
	51"(1295mm)	VZTI-7251-FNS	890.78	981.40	1081.32	1190.07	1298.93	1443.67	1533.95
	57"(1448mm)	VZTI-7257-FNS	939.76	1037.83	1145.98	1263.68	1381.47	1538.12	1635.82

Tiles - Full Panel, Connections and Stack Frame

Laminate

Unique Features

- High Pressure Laminate (HPL) tile has 1mm edgeband
- 72"(1829mm)W is not available on 56"(1422mm), 64"(1626mm) or 72"(1829mm)H tiles.
- Wood grain laminate can be vertical or horizontal. See illustrations below for limitations. Specify appropriate laminate surface code.



To Order, Specify:

1) Product number, including:

1 Technology Port Option:

- N** No Technology Access
- L** Left-Hand Port (add **\$87.40** list)
- R** Right-Hand Port (add **\$87.40** list)
- 2** Left and Right- Hand Port (add **\$208.28** list)

2) Laminate surface color.

3) Edgeband color.

4) Trim color for bezel (if applicable).

Nominal Height	Nominal Width	Number ①	HPL	
			A	B
Individual Tiles				
8"(203mm)	18"(457mm)	VZTI-0818-DNN	\$ 253.63	\$ 265.13
	24"(610mm)	VZTI-0824-DNN	282.90	295.94
	30"(762mm)	VZTI-0830-DNN	297.17	311.74
	36"(914mm)	VZTI-0836-DNN	311.44	327.55
	42"(1067mm)	VZTI-0842-DNN	315.71	333.36
	48"(1219mm)	VZTI-0848-DNN	334.98	354.16
	54"(1372mm)	VZTI-0854-DNN	354.25	374.97
	60"(1524mm)	VZTI-0860-DNN	373.52	395.78
16"(406mm)	18"(457mm)	VZTI-1618-DNN	\$ 286.44	\$ 302.55
	24"(610mm)	VZTI-1624-D N	334.98	354.16
	30"(762mm)	VZTI-1630-D N	368.52	390.78
	36"(914mm)	VZTI-1636-D N	402.06	427.39
	42"(1067mm)	VZTI-1642-D N	425.60	454.00
	48"(1219mm)	VZTI-1648-D N	464.14	495.62
	54"(1372mm)	VZTI-1654-D N	502.68	537.23
	60"(1524mm)	VZTI-1660-D N	541.22	578.84
24"(610mm)	18"(457mm)	VZTI-2418-DNN	\$ 294.25	\$ 314.97
	24"(610mm)	VZTI-2424-D N	362.06	387.39
	30"(762mm)	VZTI-2430-D N	414.87	444.81
	36"(914mm)	VZTI-2436-D N	467.68	502.23
	42"(1067mm)	VZTI-2442-D N	510.49	549.65
	48"(1219mm)	VZTI-2448-D N	568.30	612.07
	54"(1372mm)	VZTI-2454-D N	626.11	674.49
	60"(1524mm)	VZTI-2460-D N	683.92	736.91
32"(813mm)	18"(457mm)	VZTI-3218-DNN	\$ 377.06	\$ 402.39
	24"(610mm)	VZTI-3224-D N	464.14	495.62
	30"(762mm)	VZTI-3230-D N	536.22	573.84
	36"(914mm)	VZTI-3236-D N	608.30	652.07
	42"(1067mm)	VZTI-3242-D N	670.38	720.30
	48"(1219mm)	VZTI-3248-D N	747.46	803.52
	54"(1372mm)	VZTI-3254-D N	824.54	886.75
	60"(1524mm)	VZTI-3260-D N	901.62	969.98
72"(1829mm)	18"(457mm)	VZTI-3272-D N	1124.58	N/A

Tiles - Full Panel, Connections and Stack Frame

Nominal Height	Nominal Width	Number	HPL	
			A	B
40"(1016mm)	18"(457mm)	VZTI-4018-DNN	\$ 449.87	\$ 479.81
	24"(610mm)	VZTI-4024-DNN	556.22	593.84
	30"(762mm)	VZTI-4030-DNN	647.57	692.88
	36"(914mm)	VZTI-4036-DNN	738.92	791.91
	42"(1067mm)	VZTI-4042-DNN	820.27	880.94
	48"(1219mm)	VZTI-4048-DNN	916.62	984.98
	54"(1372mm)	VZTI-4054-DNN	1012.97	1089.01
	60"(1524mm)	VZTI-4060-DNN	1109.32	1193.04
48"(1219mm)	18"(457mm)	VZTI-4818-DNN	\$ 467.68	\$ 502.23
	24"(610mm)	VZTI-4824-DNN	593.30	637.07
	30"(762mm)	VZTI-4830-DNN	703.92	756.91
	36"(914mm)	VZTI-4836-DNN	814.54	876.75
	42"(1067mm)	VZTI-4842-DNN	915.16	986.59
	48"(1219mm)	VZTI-4848-DNN	1030.78	1111.43
	54"(1372mm)	VZTI-4854-DNN	1146.40	1236.27
	60"(1524mm)	VZTI-4860-DNN	1262.02	1361.11
56"(1422mm)	18"(457mm)	VZTI-5618-DNN	\$ 525.49	\$ 564.65
	24"(610mm)	VZTI-5624-DNN	670.38	720.30
	30"(762mm)	VZTI-5630-DNN	800.27	860.94
	36"(914mm)	VZTI-5636-DNN	930.16	1001.59
	42"(1067mm)	VZTI-5642-DNN	1050.05	1132.24
	48"(1219mm)	VZTI-5648-DNN	1184.94	1277.88
	54"(1372mm)	VZTI-5654-DNN	1319.83	1423.53
	60"(1524mm)	VZTI-5660-DNN	1454.72	1569.18
64"(1626mm)	18"(457mm)	VZTI-6418-DNN	\$ 1147.18	\$ 1190.95
	24"(610mm)	VZTI-6424-DNN	1311.34	1367.40
	30"(762mm)	VZTI-6430-DNN	1460.50	1528.86
	36"(914mm)	VZTI-6436-DNN	1609.66	1690.31
	42"(1067mm)	VZTI-6442-DNN	1748.82	1841.76
	48"(1219mm)	VZTI-6448-DNN	1902.98	2008.22
	54"(1372mm)	VZTI-6454-DNN	2057.14	2174.67
	60"(1524mm)	VZTI-6460-DNN	2211.30	2341.12
72"(1829mm)	18"(457mm)	VZTI-7218-DNN	\$ 1204.99	\$ 1253.37
	24"(610mm)	VZTI-7224-DNN	1388.42	1450.63
	30"(762mm)	VZTI-7230-DNN	1556.85	1632.89
	36"(914mm)	VZTI-7236-DNN	1725.28	1815.15
	42"(1067mm)	VZTI-7242-DNN	1883.71	1987.41
	48"(1219mm)	VZTI-7248-DNN	2057.14	2174.67
	54"(1372mm)	VZTI-7254-DNN	2230.57	2361.93
	60"(1524mm)	VZTI-7260-DNN	2404.00	2549.19
Spanning In-line Tiles				
8"(203mm)	36"(914mm)	VZTI-0836-DNS	\$ 593.38	\$ 609.49
	42"(1067mm)	VZTI-0842-DNS	597.65	615.30
	48"(1219mm)	VZTI-0848-DNS	616.92	636.10
	54"(1372mm)	VZTI-0854-DNS	636.19	656.91
	60"(1524mm)	VZTI-0860-DNS	655.46	677.72
	66"(1676mm)	VZTI-0866-DNS	674.73	N/A
	72"(1829mm)	VZTI-0872-DNS	762.80	N/A
	78"(1981mm)	VZTI-0878-DNS	782.07	N/A
	84"(2134mm)	VZTI-0884-DNS	801.34	N/A
	90"(2286mm)	VZTI-0890-DNS	820.61	N/A
	96"(2438mm)	VZTI-0896-DNS	839.88	N/A

Tiles - Full Panel, Connections and Stack Frame

Nominal Height	Nominal Width	Number	HPL	
			A	B
16"(406mm)	36"(914mm)	VZTI-1636-DNS	\$ 684.00	\$ 709.33
	42"(1067mm)	VZTI-1642-DNS	707.54	735.94
	48"(1219mm)	VZTI-1648-DNS	746.08	777.56
	54"(1372mm)	VZTI-1654-DNS	784.62	819.17
	60"(1524mm)	VZTI-1660-DNS	823.16	860.78
	66"(1676mm)	VZTI-1666-DNS	861.70	N/A
	72"(1829mm)	VZTI-1672-DNS	969.04	N/A
	78"(1981mm)	VZTI-1678-DNS	1007.58	N/A
	84"(2134mm)	VZTI-1684-DNS	1046.12	N/A
	90"(2286mm)	VZTI-1690-DNS	1084.66	N/A
24"(610mm)	96"(2438mm)	VZTI-1696-DNS	1123.20	N/A
	36"(914mm)	VZTI-2436-DNS	\$ 749.62	\$ 784.17
	42"(1067mm)	VZTI-2442-DNS	792.43	831.59
	48"(1219mm)	VZTI-2448-DNS	850.24	894.01
	54"(1372mm)	VZTI-2454-DNS	908.05	956.43
	60"(1524mm)	VZTI-2460-DNS	965.86	1018.85
	66"(1676mm)	VZTI-2466-DNS	1023.67	N/A
	72"(1829mm)	VZTI-2472-DNS	1150.28	N/A
	78"(1981mm)	VZTI-2478-DNS	1208.09	N/A
	84"(2134mm)	VZTI-2484-DNS	1265.90	N/A
32"(813mm)	90"(2286mm)	VZTI-2490-DNS	1323.71	N/A
	96"(2438mm)	VZTI-2496-DNS	1381.52	N/A
	36"(914mm)	VZTI-3236-DNS	\$ 890.24	\$ 934.01
	42"(1067mm)	VZTI-3242-DNS	952.32	1002.24
	48"(1219mm)	VZTI-3248-DNS	1029.40	1085.46
	54"(1372mm)	VZTI-3254-DNS	1106.48	1168.69
	60"(1524mm)	VZTI-3260-DNS	1183.56	1251.92
	66"(1676mm)	VZTI-3266-DNS	1260.64	N/A
	72"(1829mm)	VZTI-3272-DNS	1406.52	N/A
	78"(1981mm)	VZTI-3278-DNS	1483.60	N/A
40"(1016mm)	84"(2134mm)	VZTI-3284-DNS	1560.68	N/A
	90"(2286mm)	VZTI-3290-DNS	1637.76	N/A
	96"(2438mm)	VZTI-3296-DNS	1714.84	N/A
	36"(914mm)	VZTI-4036-DNS	\$1020.86	\$ 1073.85
	42"(1067mm)	VZTI-4042-DNS	1102.21	1162.88
	48"(1219mm)	VZTI-4048-DNS	1198.56	1266.92
	54"(1372mm)	VZTI-4054-DNS	1294.91	1370.95
	60"(1524mm)	VZTI-4060-DNS	1391.26	1474.98
	66"(1676mm)	VZTI-4066-DNS	1487.61	N/A
	72"(1829mm)	VZTI-4072-DNS	1652.76	N/A
40"(1016mm)	78"(1981mm)	VZTI-4078-DNS	1749.11	N/A
	84"(2134mm)	VZTI-4084-DNS	1845.46	N/A
	90"(2286mm)	VZTI-4090-DNS	1941.81	N/A
	96"(2438mm)	VZTI-4096-DNS	2038.16	N/A

Tiles - Full Panel, Connections and Stack Frame

Nominal Height	Nominal Width	Number	HPL	
			A	B
48"(1219mm)	36"(914mm)	VZTI-4836-DNS	\$ 1096.48	\$ 1158.69
	42"(1067mm)	VZTI-4842-DNS	1197.10	1268.53
	48"(1219mm)	VZTI-4848-DNS	1312.72	1393.37
	54"(1372mm)	VZTI-4854-DNS	1428.34	1518.21
	60"(1524mm)	VZTI-4860-DNS	1543.96	1643.05
	66"(1676mm)	VZTI-4866-DNS	1659.58	N/A
	72"(1829mm)	VZTI-4872-DNS	1844.00	N/A
	78"(1981mm)	VZTI-4878-DNS	1959.62	N/A
	84"(2134mm)	VZTI-4884-DNS	2075.24	N/A
	90"(2286mm)	VZTI-4890-DNS	2190.86	N/A
56"(1422mm)	96"(2438mm)	VZTI-4896-DNS	2306.48	N/A
	36"(914mm)	VZTI-5636-DNS	\$ 1212.10	\$ 1283.53
	42"(1067mm)	VZTI-5642-DNS	1331.99	1414.18
	48"(1219mm)	VZTI-5648-DNS	1466.88	1559.82
	54"(1372mm)	VZTI-5654-DNS	1601.77	1705.47
	60"(1524mm)	VZTI-5660-DNS	1736.66	1851.12
64"(1626mm)	36"(914mm)	VZTI-6436-DNS	\$ 1891.60	\$ 1972.25
	42"(1067mm)	VZTI-6442-DNS	2030.76	2123.70
	48"(1219mm)	VZTI-6448-DNS	2184.92	2290.16
	54"(1372mm)	VZTI-6454-DNS	2339.08	2456.61
	60"(1524mm)	VZTI-6460-DNS	2493.24	2623.06
72"(1829mm)	36"(914mm)	VZTI-7236-DNS	\$2007.22	\$2097.09
	42"(1067mm)	VZTI-7242-DNS	2165.65	2269.35
	48"(1219mm)	VZTI-7248-DNS	2339.08	2456.61
	54"(1372mm)	VZTI-7254-DNS	2512.51	2643.87
	60"(1524mm)	VZTI-7260-DNS	2685.94	2831.13
Spanning 3-Way Intersection Tiles				
8"(203mm)	39"(991mm)	VZTI-0839-DNS	\$ 588.01	\$ 604.89
	45"(1143mm)	VZTI-0845-DNS	607.28	625.70
	51"(1295mm)	VZTI-0851-DNS	626.56	646.51
	57"(1448mm)	VZTI-0857-DNS	645.83	667.31
	63"(1600mm)	VZTI-0863-DNS	665.10	N/A
	69"(1753mm)	VZTI-0869-DNS	684.36	N/A
	75"(1905mm)	VZTI-0875-DNS	772.44	N/A
	81"(2057mm)	VZTI-0881-DNS	791.71	N/A
	93"(2362mm)	VZTI-0893-DNS	830.24	N/A
	99"(2515mm)	VZTI-0899-DNS	849.51	N/A
16"(406mm)	39"(991mm)	VZTI-1639-DNS	\$ 688.27	\$ 715.14
	45"(1143mm)	VZTI-1645-DNS	726.81	756.75
	51"(1295mm)	VZTI-1651-DNS	765.35	798.36
	57"(1448mm)	VZTI-1657-DNS	803.89	839.98
	63"(1600mm)	VZTI-1663-DNS	842.43	N/A
	69"(1753mm)	VZTI-1669-DNS	880.97	N/A
	75"(1905mm)	VZTI-1675-DNS	988.31	N/A
	81"(2057mm)	VZTI-1681-DNS	1026.85	N/A
	93"(2362mm)	VZTI-1693-DNS	1103.93	N/A
	99"(2515mm)	VZTI-1699-DNS	1142.47	N/A

Tiles - Full Panel, Connections and Stack Frame

Nominal Height	Nominal Width	Number	HPL	
			A	B
24"(610mm)	39"(991mm)	VZTI-2439-DNS	\$ 763.53	\$ 800.38
	45"(1143mm)	VZTI-2445-DNS	821.33	862.80
	51"(1295mm)	VZTI-2451-DNS	879.15	925.22
	57"(1448mm)	VZTI-2457-DNS	936.95	987.64
	63"(1600mm)	VZTI-2463-DNS	994.77	N/A
	69"(1753mm)	VZTI-2469-DNS	1052.57	N/A
	75"(1905mm)	VZTI-2475-DNS	1179.18	N/A
	81"(2057mm)	VZTI-2481-DNS	1236.99	N/A
	93"(2362mm)	VZTI-2493-DNS	1352.61	N/A
	99"(2515mm)	VZTI-2499-DNS	1410.42	N/A
32"(813mm)	39"(991mm)	VZTI-3239-DNS	\$ 913.78	\$ 960.62
	45"(1143mm)	VZTI-3245-DNS	990.86	1043.85
	51"(1295mm)	VZTI-3251-DNS	1067.94	1127.08
	57"(1448mm)	VZTI-3257-DNS	1145.02	1210.30
	63"(1600mm)	VZTI-3263-DNS	1222.10	N/A
	69"(1753mm)	VZTI-3269-DNS	1299.18	N/A
	75"(1905mm)	VZTI-3275-DNS	1445.06	N/A
	81"(2057mm)	VZTI-3281-DNS	1522.14	N/A
	93"(2362mm)	VZTI-3293-DNS	1676.30	N/A
	99"(2515mm)	VZTI-3299-DNS	1753.38	N/A
40"(1016mm)	39"(991mm)	VZTI-4039-DNS	\$ 1054.03	\$ 1110.87
	45"(1143mm)	VZTI-4045-DNS	1150.38	1214.90
	51"(1295mm)	VZTI-4051-DNS	1246.73	1318.93
	57"(1448mm)	VZTI-4057-DNS	1343.08	1422.97
	63"(1600mm)	VZTI-4063-DNS	1439.43	N/A
	69"(1753mm)	VZTI-4069-DNS	1535.78	N/A
	75"(1905mm)	VZTI-4075-DNS	1700.94	N/A
	81"(2057mm)	VZTI-4081-DNS	1797.29	N/A
	93"(2362mm)	VZTI-4093-DNS	1989.98	N/A
	99"(2515mm)	VZTI-4099-DNS	2086.34	N/A
48"(1219mm)	39"(991mm)	VZTI-4839-DNS	\$ 1139.29	\$ 1206.11
	45"(1143mm)	VZTI-4845-DNS	1254.91	1330.95
	51"(1295mm)	VZTI-4851-DNS	1370.53	1455.79
	57"(1448mm)	VZTI-4857-DNS	1486.15	1580.63
	63"(1600mm)	VZTI-4863-DNS	1601.77	N/A
	69"(1753mm)	VZTI-4869-DNS	1717.39	N/A
	75"(1905mm)	VZTI-4875-DNS	1901.81	N/A
	81"(2057mm)	VZTI-4881-DNS	2017.43	N/A
	93"(2362mm)	VZTI-4893-DNS	2248.67	N/A
	99"(2515mm)	VZTI-4899-DNS	2364.29	N/A
56"(1422mm)	39"(991mm)	VZTI-5639-DNS	\$ 1264.55	\$ 1341.35
	45"(1143mm)	VZTI-5645-DNS	1399.44	1487.00
	51"(1295mm)	VZTI-5651-DNS	1534.32	1632.65
	57"(1448mm)	VZTI-5657-DNS	1669.22	1778.29
64"(1626mm)	39"(991mm)	VZTI-6439-DNS	\$ 1953.68	\$2040.48
	45"(1143mm)	VZTI-6445-DNS	2107.84	2206.93
	51"(1295mm)	VZTI-6451-DNS	2262.00	2373.38
	57"(1448mm)	VZTI-6457-DNS	2416.16	2539.84
72"(1829mm)	39"(991mm)	VZTI-7239-DNS	\$2078.94	\$ 2175.72
	45"(1143mm)	VZTI-7245-DNS	2252.36	2362.98
	51"(1295mm)	VZTI-7251-DNS	2425.79	2550.24
	57"(1448mm)	VZTI-7257-DNS	2599.22	2737.50

Tiles - Full Panel, Connections and Stack Frame

Steel

Unique Features

- Powdercoat finish.
- For use with magnetic accessories.

To Order, Specify:

1) Product number, including:

1 Technology Port Option:

- N** No Technology Access
- L** Left-Hand Port (add **\$87.40** list)
- R** Right-Hand Port (add **\$87.40** list)
- 2** Left and Right-Hand Port (add **\$209.75** list)

2) Trim color.

3) Trim color for bezel (if applicable).

Nominal Height	Nominal Width	Number ①	Trim	
			A	B
Individual Tiles				
8"(203mm)	18"(457mm)	VZTI-0818-PNN	\$ 153.35	\$ 158.62
	24"(610mm)	VZTI-0824-PNN	163.39	170.42
	30"(762mm)	VZTI-0830-PNN	173.43	182.22
	36"(914mm)	VZTI-0836-PNN	183.47	194.02
	42"(1067mm)	VZTI-0842-PNN	193.51	205.82
	48"(1219mm)	VZTI-0848-PNN	203.55	217.62
	54"(1372mm)	VZTI-0854-PNN	213.59	229.42
	60"(1524mm)	VZTI-0860-PNN	223.63	241.22
16"(406mm)	72"(1829mm)	VZTI-0872-PNN	283.29	304.40
	18"(457mm)	VZTI-1618-PNN	\$ 198.60	\$ 208.72
	24"(610mm)	VZTI-1624-P N	214.48	228.64
	30"(762mm)	VZTI-1630-P N	230.36	248.56
	36"(914mm)	VZTI-1636-P N	246.24	268.48
	42"(1067mm)	VZTI-1642-P N	262.12	288.40
	48"(1219mm)	VZTI-1648-P N	278.00	308.32
	54"(1372mm)	VZTI-1654-P N	293.88	328.24
24"(610mm)	60"(1524mm)	VZTI-1660-P N	309.76	348.16
	72"(1829mm)	VZTI-1672-P N	420.68	467.16
	18"(457mm)	VZTI-2418-PNN	\$ 257.86	\$ 273.19
	24"(610mm)	VZTI-2424-P N	279.88	301.39
	30"(762mm)	VZTI-2430-P N	301.90	329.59
	36"(914mm)	VZTI-2436-P N	323.92	357.79
	42"(1067mm)	VZTI-2442-P N	345.94	385.99
	48"(1219mm)	VZTI-2448-P N	367.96	414.19
32"(813mm)	54"(1372mm)	VZTI-2454-P N	389.98	442.39
	60"(1524mm)	VZTI-2460-P N	412.00	470.59
	72"(1829mm)	VZTI-2472-P N	574.78	645.73
	18"(457mm)	VZTI-3218-PNN	\$ 329.53	\$ 349.83
	24"(610mm)	VZTI-3224-P N	356.21	384.55
	30"(762mm)	VZTI-3230-P N	382.89	419.27
	36"(914mm)	VZTI-3236-P N	409.57	453.99
	42"(1067mm)	VZTI-3242-P N	436.25	488.71
40"(1016mm)	48"(1219mm)	VZTI-3248-P N	462.93	523.43
	54"(1372mm)	VZTI-3254-P N	489.61	558.15
	60"(1524mm)	VZTI-3260-P N	516.29	592.87
	72"(1829mm)	VZTI-3272-P N	727.97	820.63
	18"(457mm)	VZTI-4018-PNN	\$ 347.48	\$ 372.96
	24"(610mm)	VZTI-4024-PNN	381.86	417.82
	30"(762mm)	VZTI-4030-PNN	416.24	462.68
	36"(914mm)	VZTI-4036-PNN	450.62	507.54
40"(1016mm)	42"(1067mm)	VZTI-4042-PNN	485.00	552.40
	48"(1219mm)	VZTI-4048-PNN	519.38	597.26
	54"(1372mm)	VZTI-4054-PNN	553.76	642.12
	60"(1524mm)	VZTI-4060-PNN	588.14	686.98
	72"(1829mm)	VZTI-4072-PNN	854.80	974.60

Tiles - Full Panel, Connections and Stack Frame

Nominal Height	Nominal Width	Number	Trim	
			A	B
Spanning In-Line Tiles				
8"(203mm)	36"(914mm)	VZTI-0836-PNS	\$ 313.22	\$ 323.77
	42"(1067mm)	VZTI-0842-PNS	323.26	335.57
	48"(1219mm)	VZTI-0848-PNS	333.30	347.37
	54"(1372mm)	VZTI-0854-PNS	343.34	359.17
	60"(1524mm)	VZTI-0860-PNS	353.38	370.97
	66"(1676mm)	VZTI-0866-PNS	363.42	382.77
	72"(1829mm)	VZTI-0872-PNS	373.46	394.57
	78"(1981mm)	VZTI-0878-PNS	383.50	406.37
16"(406mm)	36"(914mm)	VZTI-1636-PNS	\$362.05	\$ 384.29
	42"(1067mm)	VZTI-1642-PNS	377.93	404.21
	48"(1219mm)	VZTI-1648-PNS	393.81	424.13
	54"(1372mm)	VZTI-1654-PNS	409.69	444.05
	60"(1524mm)	VZTI-1660-PNS	425.57	463.97
	66"(1676mm)	VZTI-1666-PNS	441.45	483.89
	72"(1829mm)	VZTI-1672-PNS	457.33	503.81
	78"(1981mm)	VZTI-1678-PNS	473.21	523.73
24"(610mm)	36"(914mm)	VZTI-2436-PNS	\$ 384.75	\$ 418.62
	42"(1067mm)	VZTI-2442-PNS	406.77	446.82
	48"(1219mm)	VZTI-2448-PNS	428.79	475.02
	54"(1372mm)	VZTI-2454-PNS	450.81	503.22
	60"(1524mm)	VZTI-2460-PNS	472.83	531.42
	66"(1676mm)	VZTI-2466-PNS	494.85	559.62
	72"(1829mm)	VZTI-2472-PNS	516.87	587.82
	78"(1981mm)	VZTI-2478-PNS	538.89	616.02
32"(813mm)	36"(914mm)	VZTI-3236-PNS	\$ 528.31	\$ 572.73
	42"(1067mm)	VZTI-3242-PNS	554.99	607.45
	48"(1219mm)	VZTI-3248-PNS	581.67	642.17
	54"(1372mm)	VZTI-3254-PNS	608.35	676.89
	60"(1524mm)	VZTI-3260-PNS	635.03	711.61
	66"(1676mm)	VZTI-3266-PNS	661.71	746.33
	72"(1829mm)	VZTI-3272-PNS	688.39	781.05
	78"(1981mm)	VZTI-3278-PNS	715.07	815.77
40"(1016mm)	36"(914mm)	VZTI-4036-PNS	\$658.82	\$ 715.74
	42"(1067mm)	VZTI-4042-PNS	693.20	760.60
	48"(1219mm)	VZTI-4048-PNS	727.58	805.46
	54"(1372mm)	VZTI-4054-PNS	761.96	850.32
	60"(1524mm)	VZTI-4060-PNS	796.34	895.18
	66"(1676mm)	VZTI-4066-PNS	830.72	940.04
	72"(1829mm)	VZTI-4072-PNS	865.10	984.90
	78"(1981mm)	VZTI-4078-PNS	899.48	1029.76

Tiles - Full Panel, Connections and Stack Frame

Nominal Height	Nominal Width	Number	Trim	
			A	B
Spanning 3-Way Intersection Tiles				
8"(203mm)	39"(991mm)	VZTI-0839-PNS	\$ 318.24	\$ 329.67
	45"(1143mm)	VZTI-0845-PNS	328.28	341.47
	51"(1295mm)	VZTI-0851-PNS	338.32	353.27
	57"(1448mm)	VZTI-0857-PNS	348.36	365.07
	63"(1600mm)	VZTI-0863-PNS	358.40	376.87
	69"(1753mm)	VZTI-0869-PNS	368.44	388.67
	75"(1905mm)	VZTI-0875-PNS	378.48	400.47
16"(406mm)	39"(991mm)	VZTI-1639-PNS	\$369.99	\$ 394.25
	45"(1143mm)	VZTI-1645-PNS	385.87	414.17
	51"(1295mm)	VZTI-1651-PNS	401.75	434.09
	57"(1448mm)	VZTI-1657-PNS	417.63	454.01
	63"(1600mm)	VZTI-1663-PNS	433.51	473.93
	69"(1753mm)	VZTI-1669-PNS	449.39	493.85
	75"(1905mm)	VZTI-1675-PNS	465.27	513.77
24"(610mm)	39"(991mm)	VZTI-2439-PNS	\$ 395.76	\$ 432.72
	45"(1143mm)	VZTI-2445-PNS	417.78	460.92
	51"(1295mm)	VZTI-2451-PNS	439.80	489.12
	57"(1448mm)	VZTI-2457-PNS	461.82	517.32
	63"(1600mm)	VZTI-2463-PNS	483.84	545.52
	69"(1753mm)	VZTI-2469-PNS	505.86	573.72
	75"(1905mm)	VZTI-2475-PNS	527.88	601.92
32"(813mm)	39"(991mm)	VZTI-3239-PNS	\$ 541.65	\$ 590.09
	45"(1143mm)	VZTI-3245-PNS	568.33	624.81
	51"(1295mm)	VZTI-3251-PNS	595.01	659.53
	57"(1448mm)	VZTI-3257-PNS	621.69	694.25
	63"(1600mm)	VZTI-3263-PNS	648.37	728.97
	69"(1753mm)	VZTI-3269-PNS	675.05	763.69
	75"(1905mm)	VZTI-3275-PNS	701.73	798.41
40"(1016mm)	39"(991mm)	VZTI-4039-PNS	\$ 676.01	\$ 738.17
	45"(1143mm)	VZTI-4045-PNS	710.39	783.03
	51"(1295mm)	VZTI-4051-PNS	744.77	827.89
	57"(1448mm)	VZTI-4057-PNS	779.15	872.75
	63"(1600mm)	VZTI-4063-PNS	813.53	917.61
	69"(1753mm)	VZTI-4069-PNS	847.91	962.47
	75"(1905mm)	VZTI-4075-PNS	882.29	1007.33

Tiles - Full Panel, Connections and Stack Frame

Wood

Unique Features

- Low gloss finish for double-cut veneer wood tiles.
- Standard gloss finish for natural wood tiles.



Double-cut Veneer
Horizontal grain direction



Natural Veneer
Vertical grain direction

To Order, Specify:

1) Product number, including:

1 Technology Port Option:

- N** No Technology Access
- L** Left-Hand Port (add **\$87.40** list)
- R** Right-Hand Port (add **\$87.40** list)
- 2** Left and Right-Hand Port (add **\$209.75** list)

2) Wood finish color.

3) Trim color for bezel (if applicable).

Note: 54"(1372mm), 60"(1524mm), and 72"(1829mm)W is not available for 56"(1422mm), 64"(1626mm) and 72"(1829mm)H tile.

Nominal Height	Nominal Width	Number ①	Wood	
			A	B
Individual Tiles				
8"(203mm)	18"(457mm)	VZTI-0818-WNN	\$ 644.96	\$ 754.94
	24"(610mm)	VZTI-0824-WNN	669.44	782.90
	30"(762mm)	VZTI-0830-WNN	693.92	810.86
	36"(914mm)	VZTI-0836-WNN	718.40	838.82
	42"(1067mm)	VZTI-0842-WNN	742.88	866.78
	42"(1067mm)	VZTI-0848-WNN	767.36	894.74
	54"(1372mm)	VZTI-0854-WNN	791.84	922.70
	60"(1524mm)	VZTI-0860-WNN	816.32	950.66
16"(406mm)	72"(1829mm)	VZTI-0872-WNN	989.89	1131.19
	18"(457mm)	VZTI-1618-WNN	\$ 762.85	\$ 853.57
	24"(610mm)	VZTI-1624-W N	793.37	889.47
	30"(762mm)	VZTI-1630-W N	823.89	925.37
	36"(914mm)	VZTI-1636-W N	854.41	961.27
	42"(1067mm)	VZTI-1642-W N	884.93	997.17
	42"(1067mm)	VZTI-1648-W N	915.45	1033.07
	54"(1372mm)	VZTI-1654-W N	945.97	1068.97
24"(610mm)	60"(1524mm)	VZTI-1660-W N	976.49	1104.87
	72"(1829mm)	VZTI-1672-W N	1286.75	1425.89
	18"(457mm)	VZTI-2418-WNN	\$ 962.01	\$ 1011.21
	24"(610mm)	VZTI-2424-W N	1018.65	1074.11
	30"(762mm)	VZTI-2430-W N	1075.29	1137.01
	36"(914mm)	VZTI-2436-W N	1131.93	1199.91
	42"(1067mm)	VZTI-2442-W N	1188.57	1262.81
	42"(1067mm)	VZTI-2448-W N	1245.21	1325.71
32"(813mm)	54"(1372mm)	VZTI-2454-W N	1301.85	1388.61
	60"(1524mm)	VZTI-2460-W N	1358.49	1451.51
	72"(1829mm)	VZTI-2472-W N	1845.60	1951.14
	18"(457mm)	VZTI-3218-WNN	\$ 1038.71	\$ 1096.78
	24"(610mm)	VZTI-3224-W N	1103.87	1173.56
	30"(762mm)	VZTI-3230-W N	1169.03	1250.34
	36"(914mm)	VZTI-3236-W N	1234.19	1327.12
	42"(1067mm)	VZTI-3242-W N	1299.35	1403.90
32"(813mm)	42"(1067mm)	VZTI-3248-W N	1364.51	1480.68
	54"(1372mm)	VZTI-3254-W N	1429.67	1557.46
	60"(1524mm)	VZTI-3260-W N	1494.83	1634.24
	72"(1829mm)	VZTI-3272-W N	2123.59	2286.24

Tiles - Full Panel, Connections and Stack Frame

Nominal Height	Nominal Width	Number	Wood		
			A	B	
40"(1016mm)	18"(457mm)	VZTI-4018-WNN	\$ 1405.96	\$ 1482.89	
	24"(610mm)	VZTI-4024-WNN	1459.44	1545.85	
	30"(762mm)	VZTI-4030-WNN	1512.92	1608.81	
	36"(914mm)	VZTI-4036-WNN	1566.40	1671.77	
	42"(1067mm)	VZTI-4042-WNN	1619.88	1734.73	
	42"(1067mm)	VZTI-4048-WNN	1673.36	1797.69	
	54"(1372mm)	VZTI-4054-WNN	1726.84	1860.65	
	60"(1524mm)	VZTI-4060-WNN	1780.32	1923.61	
48"(1219mm)	18"(457mm)	VZTI-4818-WNN	\$ 1435.40	\$ 1533.14	
	24"(610mm)	VZTI-4824-WNN	1493.84	1600.32	
	30"(762mm)	VZTI-4830-WNN	1552.28	1667.50	
	36"(914mm)	VZTI-4836-WNN	1610.72	1734.68	
	42"(1067mm)	VZTI-4842-WNN	1669.16	1801.86	
	42"(1067mm)	VZTI-4848-WNN	1727.60	1869.04	
	54"(1372mm)	VZTI-4854-WNN	1786.04	1936.22	
	60"(1524mm)	VZTI-4860-WNN	1844.48	2003.40	
56"(1422mm)	18"(457mm)	VZTI-5618-WNN	\$ 1454.22	\$ 1555.07	
	24"(610mm)	VZTI-5624-WNN	1526.26	1637.21	
	30"(762mm)	VZTI-5630-WNN	1598.30	1719.35	
	36"(914mm)	VZTI-5636-WNN	1670.34	1801.49	
	42"(1067mm)	VZTI-5642-WNN	1742.38	1883.63	
	42"(1067mm)	VZTI-5648-WNN	1814.42	1965.77	
	64"(1626mm)	18"(457mm)	VZTI-6418-WNN	\$ 1553.55	\$ 1774.62
		24"(610mm)	VZTI-6424-WNN	1660.19	1900.26
30"(762mm)		VZTI-6430-WNN	1766.83	2025.90	
36"(914mm)		VZTI-6436-WNN	1873.47	2151.54	
42"(1067mm)		VZTI-6442-WNN	1980.11	2277.18	
42"(1067mm)		VZTI-6448-WNN	2086.75	2402.82	
72"(1829mm)		18"(457mm)	VZTI-7218-WNN	\$ 1559.79	\$ 1812.53
		24"(610mm)	VZTI-7224-WNN	1672.71	1938.39
	30"(762mm)	VZTI-7230-WNN	1785.63	2064.25	
	36"(914mm)	VZTI-7236-WNN	1898.55	2190.11	
	42"(1067mm)	VZTI-7242-WNN	2011.47	2315.97	
	42"(1067mm)	VZTI-7248-WNN	2124.39	2441.83	
	Spanning-In-Line Tiles				
	8"(203mm)	36"(914mm)	VZTI-0836-WNS	\$ 760.92	\$ 881.34
42"(1067mm)		VZTI-0842-WNS	785.40	909.30	
48"(1219mm)		VZTI-0848-WNS	831.14	958.52	
54"(1372mm)		VZTI-0854-WNS	855.62	986.48	
60"(1524mm)		VZTI-0860-WNS	880.10	1014.44	
66"(1676mm)		VZTI-0866-WNS	925.84	1063.66	
72"(1829mm)		VZTI-0872-WNS	950.32	1091.62	
78"(1981mm)		VZTI-0878-WNS	974.80	1119.58	
84"(2134mm)		VZTI-0884-WNS	1020.54	1168.80	
90"(2286mm)		VZTI-0890-WNS	1045.02	1196.76	
	96"(2438mm)	VZTI-0896-WNS	1069.50	1224.72	

Tiles - Full Panel, Connections and Stack Frame

Nominal Height	Nominal Width	Number	Wood	
			A	B
16"(406mm)	36"(914mm)	VZTI-1636-WNS	\$ 939.45	\$ 1046.31
	42"(1067mm)	VZTI-1642-WNS	991.23	1103.47
	48"(1219mm)	VZTI-1648-WNS	1021.75	1139.37
	54"(1372mm)	VZTI-1654-WNS	1073.53	1196.53
	60"(1524mm)	VZTI-1660-WNS	1125.31	1253.69
	66"(1676mm)	VZTI-1666-WNS	1155.83	1289.59
	72"(1829mm)	VZTI-1672-WNS	1207.61	1346.75
	78"(1981mm)	VZTI-1678-WNS	1259.39	1403.91
	84"(2134mm)	VZTI-1684-WNS	1289.91	1439.81
	90"(2286mm)	VZTI-1690-WNS	1341.69	1496.97
24"(610mm)	36"(914mm)	VZTI-2436-WNS	\$ 1259.49	\$ 1327.47
	42"(1067mm)	VZTI-2442-WNS	1337.39	1411.63
	48"(1219mm)	VZTI-2448-WNS	1415.29	1495.79
	54"(1372mm)	VZTI-2454-WNS	1493.19	1579.95
	60"(1524mm)	VZTI-2460-WNS	1571.09	1664.11
	66"(1676mm)	VZTI-2466-WNS	1648.99	1748.27
	72"(1829mm)	VZTI-2472-WNS	1726.89	1832.43
	78"(1981mm)	VZTI-2478-WNS	1804.79	1916.59
	84"(2134mm)	VZTI-2484-WNS	1882.69	2000.75
	90"(2286mm)	VZTI-2490-WNS	1960.59	2084.91
32"(813mm)	36"(914mm)	VZTI-3236-WNS	\$ 1404.27	\$ 1497.20
	42"(1067mm)	VZTI-3242-WNS	1490.69	1595.24
	48"(1219mm)	VZTI-3248-WNS	1598.37	1714.54
	54"(1372mm)	VZTI-3254-WNS	1684.79	1812.58
	60"(1524mm)	VZTI-3260-WNS	1771.21	1910.62
	66"(1676mm)	VZTI-3266-WNS	1878.89	2029.92
	72"(1829mm)	VZTI-3272-WNS	1965.31	2127.96
	78"(1981mm)	VZTI-3278-WNS	2051.73	2226.00
	84"(2134mm)	VZTI-3284-WNS	2159.41	2345.30
	90"(2286mm)	VZTI-3290-WNS	2245.83	2443.34
40"(1016mm)	36"(914mm)	VZTI-4036-WNS	\$ 1779.00	\$ 1884.37
	42"(1067mm)	VZTI-4042-WNS	1875.00	1989.85
	48"(1219mm)	VZTI-4048-WNS	1949.74	2074.07
	54"(1372mm)	VZTI-4054-WNS	2045.74	2179.55
	60"(1524mm)	VZTI-4060-WNS	2141.74	2285.03
	66"(1676mm)	VZTI-4066-WNS	2216.48	2369.25
	72"(1829mm)	VZTI-4072-WNS	2312.48	2474.73
	78"(1981mm)	VZTI-4078-WNS	2408.48	2580.21
	84"(2134mm)	VZTI-4084-WNS	2483.22	2664.43
	90"(2286mm)	VZTI-4090-WNS	2579.22	2769.91
48"(1219mm)	36"(914mm)	VZTI-4836-WNS	\$ 1865.84	\$ 1989.80
	42"(1067mm)	VZTI-4842-WNS	1966.80	2099.50
	48"(1219mm)	VZTI-4848-WNS	2067.76	2209.20
	54"(1372mm)	VZTI-4854-WNS	2168.72	2318.90
	60"(1524mm)	VZTI-4860-WNS	2269.68	2428.60
	66"(1676mm)	VZTI-4866-WNS	2370.64	2538.30
	72"(1829mm)	VZTI-4872-WNS	2471.60	2648.00
	78"(1981mm)	VZTI-4878-WNS	2572.56	2757.70
	84"(2134mm)	VZTI-4884-WNS	2673.52	2867.40
	90"(2286mm)	VZTI-4890-WNS	2774.48	2977.10
96"(2438mm)	36"(914mm)	VZTI-4896-WNS	2875.44	3086.80

Tiles - Full Panel, Connections and Stack Frame

Nominal Height	Nominal Width	Number	Wood	
			A	B
56"(1422mm)	36"(914mm)	VZTI-5636-WNS	\$ 1967.98	\$ 2099.13
	42"(1067mm)	VZTI-5642-WNS	2082.54	2223.79
	48"(1219mm)	VZTI-5648-WNS	2218.36	2369.71
64"(1626mm)	36"(914mm)	VZTI-6436-WNS	\$ 2213.63	\$ 2491.70
	42"(1067mm)	VZTI-6442-WNS	2384.05	2681.12
	48"(1219mm)	VZTI-6448-WNS	2533.21	2849.28
72"(1829mm)	36"(914mm)	VZTI-7236-WNS	\$ 2281.23	\$ 2572.79
	42"(1067mm)	VZTI-7242-WNS	2457.93	2762.43
	48"(1219mm)	VZTI-7248-WNS	2634.63	2952.07
Spanning 3-Way Intersection Tiles				
8"(203mm)	39"(991mm)	VZTI-0839-WNS	\$ 773.16	\$ 895.32
	45"(1143mm)	VZTI-0845-WNS	818.90	944.54
	51"(1295mm)	VZTI-0851-WNS	843.38	972.50
	57"(1448mm)	VZTI-0857-WNS	867.86	1000.46
	63"(1600mm)	VZTI-0863-WNS	913.60	1049.68
	69"(1753mm)	VZTI-0869-WNS	938.08	1077.64
	75"(1905mm)	VZTI-0875-WNS	962.56	1105.60
	81"(2057mm)	VZTI-0881-WNS	1008.30	1154.82
	93"(2362mm)	VZTI-0893-WNS	1057.26	1210.74
16"(406mm)	99"(2515mm)	VZTI-0899-WNS	1103.00	1259.96
	39"(991mm)	VZTI-1639-WNS	\$ 954.71	\$ 1064.26
	45"(1143mm)	VZTI-1645-WNS	1006.49	1121.42
	51"(1295mm)	VZTI-1651-WNS	1058.27	1178.58
	57"(1448mm)	VZTI-1657-WNS	1088.79	1214.48
	63"(1600mm)	VZTI-1663-WNS	1140.57	1271.64
	69"(1753mm)	VZTI-1669-WNS	1192.35	1328.80
	75"(1905mm)	VZTI-1675-WNS	1222.87	1364.70
	81"(2057mm)	VZTI-1681-WNS	1274.65	1421.86
24"(610mm)	93"(2362mm)	VZTI-1693-WNS	1356.95	1514.92
	99"(2515mm)	VZTI-1699-WNS	1408.73	1572.08
	39"(991mm)	VZTI-2439-WNS	\$ 1309.07	\$ 1380.18
	45"(1143mm)	VZTI-2445-WNS	1386.97	1464.34
	51"(1295mm)	VZTI-2451-WNS	1464.87	1548.50
	57"(1448mm)	VZTI-2457-WNS	1542.77	1632.66
	63"(1600mm)	VZTI-2463-WNS	1620.67	1716.82
	69"(1753mm)	VZTI-2469-WNS	1698.57	1800.98
	75"(1905mm)	VZTI-2475-WNS	1776.47	1885.14
32"(813mm)	81"(2057mm)	VZTI-2481-WNS	1854.37	1969.30
	93"(2362mm)	VZTI-2493-WNS	2010.17	2137.62
	99"(2515mm)	VZTI-2499-WNS	2088.07	2221.78
	39"(991mm)	VZTI-3239-WNS	\$ 1458.11	\$ 1556.85
	45"(1143mm)	VZTI-3245-WNS	1544.53	1654.89
	51"(1295mm)	VZTI-3251-WNS	1630.95	1752.93
	57"(1448mm)	VZTI-3257-WNS	1738.63	1872.23
	63"(1600mm)	VZTI-3263-WNS	1825.05	1970.27
	69"(1753mm)	VZTI-3269-WNS	1911.47	2068.31
75"(1905mm)	75"(1905mm)	VZTI-3275-WNS	2019.15	2187.61
	81"(2057mm)	VZTI-3281-WNS	2105.57	2285.65
	93"(2362mm)	VZTI-3293-WNS	2299.67	2502.99
	99"(2515mm)	VZTI-3299-WNS	2386.09	2601.03

Tiles - Full Panel, Connections and Stack Frame

Nominal Height	Nominal Width	Number	Wood	
			A	B
40"(1016mm)	39"(991mm)	VZTI-4039-WNS	\$ 1827.00	\$ 1937.11
	45"(1143mm)	VZTI-4045-WNS	1923.00	2042.59
	51"(1295mm)	VZTI-4051-WNS	1997.74	2126.81
	57"(1448mm)	VZTI-4057-WNS	2093.74	2232.29
	63"(1600mm)	VZTI-4063-WNS	2189.74	2337.77
	69"(1753mm)	VZTI-4069-WNS	2264.48	2421.99
	75"(1905mm)	VZTI-4075-WNS	2360.48	2527.47
	81"(2057mm)	VZTI-4081-WNS	2456.48	2632.95
	93"(2362mm)	VZTI-4093-WNS	2627.22	2822.65
	99"(2515mm)	VZTI-4099-WNS	2723.22	2928.13
48"(1219mm)	39"(991mm)	VZTI-4839-WNS	\$ 1916.32	\$2044.65
	45"(1143mm)	VZTI-4845-WNS	2017.28	2154.35
	51"(1295mm)	VZTI-4851-WNS	2118.24	2264.05
	57"(1448mm)	VZTI-4857-WNS	2219.20	2373.75
	63"(1600mm)	VZTI-4863-WNS	2320.16	2483.45
	69"(1753mm)	VZTI-4869-WNS	2421.12	2593.15
	75"(1905mm)	VZTI-4875-WNS	2522.08	2702.85
	81"(2057mm)	VZTI-4881-WNS	2623.04	2812.55
	93"(2362mm)	VZTI-4893-WNS	2824.96	3031.95
	99"(2515mm)	VZTI-4899-WNS	2925.92	3141.65
56"(1422mm)	39"(991mm)	VZTI-5639-WNS	\$2025.26	\$ 2161.46
	45"(1143mm)	VZTI-5645-WNS	2161.08	2307.38
64"(1626mm)	39"(991mm)	VZTI-6439-WNS	\$ 2288.21	\$ 2575.78
	45"(1143mm)	VZTI-6445-WNS	2458.63	2765.20
72"(1829mm)	39"(991mm)	VZTI-7239-WNS	\$ 2380.21	\$ 2678.24
	45"(1143mm)	VZTI-7245-WNS	2556.91	2867.88

Tiles - Full Panel, Connections and Stack Frame

Matched Natural Wood Tile Set

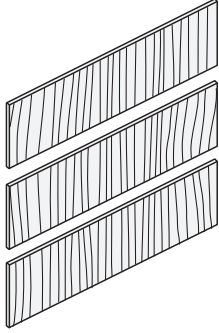

VZTQ
Class BC

Unique Features

- Consists of two or more matching natural wood tiles with attachment brackets.
- Vertical natural wood grain and color is matched between tiles.

To Order, Specify:

- 1) Product number.
- 2) Wood finish.

Note: 72"(1829mm)W is not available for 64"(1626mm) and 72"(1829mm)H.

Nominal Height	Quantity-Height	Nominal Width	Number	Wood B
24"(610mm)	One 16"(406mm), One 8"(203mm)	18"(457mm)	VZTQ-3418-ZZ	\$ 1164.97
		24"(610mm)	VZTQ-3424-ZZ	1247.17
		30"(762mm)	VZTQ-3430-ZZ	1379.37
		36"(914mm)	VZTQ-3436-ZZ	1461.57
		42"(1067mm)	VZTQ-3442-ZZ	1493.77
		48"(1219mm)	VZTQ-3448-ZZ	1575.97
		54"(1372mm)	VZTQ-3454-ZZ	1658.17
		60"(1524mm)	VZTQ-3460-ZZ	1740.37
		72"(1829mm)	VZTQ-3472-ZZ	2371.38
32"(813mm)	Two 16"(406mm)	18"(457mm)	VZTQ-4218-ZZ	\$ 1386.23
		24"(610mm)	VZTQ-4224-ZZ	1488.83
		30"(762mm)	VZTQ-4230-ZZ	1641.43
		36"(914mm)	VZTQ-4236-ZZ	1744.03
		42"(1067mm)	VZTQ-4242-ZZ	1796.63
		48"(1219mm)	VZTQ-4248-ZZ	1899.23
		54"(1372mm)	VZTQ-4254-ZZ	2001.83
		60"(1524mm)	VZTQ-4260-ZZ	2104.43
		72"(1829mm)	VZTQ-4272-ZZ	2776.24
40"(1016mm)	Two 16"(406mm), One 8"(203mm)	18"(457mm)	VZTQ-5018-ZZZ	\$ 1562.53
		24"(610mm)	VZTQ-5024-ZZZ	1684.45
		30"(762mm)	VZTQ-5030-ZZZ	1856.37
		36"(914mm)	VZTQ-5036-ZZZ	1978.29
		42"(1067mm)	VZTQ-5042-ZZZ	2050.21
		48"(1219mm)	VZTQ-5048-ZZZ	2172.13
		54"(1372mm)	VZTQ-5054-ZZZ	2294.05
		60"(1524mm)	VZTQ-5060-ZZZ	2415.97
		72"(1829mm)	VZTQ-5072-ZZZ	3126.42

Tiles - Full Panel, Connections and Stack Frame

Nominal Height	Quantity-Height	Nominal Width	Number	Wood B
48"(1219mm)	Three 16"(406mm)	18"(457mm)	VZTQ-5818-ZZZ	\$ 1683.78
		24"(610mm)	VZTQ-5824-ZZZ	1820.82
		30"(762mm)	VZTQ-5830-ZZZ	2007.86
		36"(914mm)	VZTQ-5836-ZZZ	2144.90
		42"(1067mm)	VZTQ-5842-ZZZ	2231.94
		48"(1219mm)	VZTQ-5848-ZZZ	2368.98
		54"(1372mm)	VZTQ-5854-ZZZ	2506.02
		60"(1524mm)	VZTQ-5860-ZZZ	2643.06
		72"(1829mm)	VZTQ-5872-ZZZ	3383.75
56"(1422mm)	Three 16"(406mm), One 8"(203mm)	18"(457mm)	VZTQ-6618-ZZZZ	\$ 1958.21
		24"(610mm)	VZTQ-6624-ZZZZ	2121.89
		30"(762mm)	VZTQ-6630-ZZZZ	2335.57
		36"(914mm)	VZTQ-6636-ZZZZ	2499.25
		42"(1067mm)	VZTQ-6642-ZZZZ	2612.93
		48"(1219mm)	VZTQ-6648-ZZZZ	2776.61
		54"(1372mm)	VZTQ-6654-ZZZZ	2940.29
		60"(1524mm)	VZTQ-6660-ZZZZ	3103.97
64"(1626mm)	Four 16"(406mm)	18"(457mm)	VZTQ-7418-ZZZZ	\$ 2079.57
		24"(610mm)	VZTQ-7424-ZZZZ	2236.83
		30"(762mm)	VZTQ-7430-ZZZZ	2444.09
		36"(914mm)	VZTQ-7436-ZZZZ	2601.35
		42"(1067mm)	VZTQ-7442-ZZZZ	2708.61
		48"(1219mm)	VZTQ-7448-ZZZZ	2865.87
		54"(1372mm)	VZTQ-7454-ZZZZ	3023.13
		60"(1524mm)	VZTQ-7460-ZZZZ	3180.39

Tiles - Full Panel, Connections and Stack Frame

Markerboard



VZTI-MNN
Class BC

Unique Features

- Markerboard tile may not span frames
- Tray, markers and eraser not included.
- The following products are recommended to maintain the markerboard appearance:
 - Dry erase marker kit (includes holder, six markers and eraser), order part# 7062-8001.
 - Markerboard cleaner and conditioner, order part# 7031-7001.
 - Markerboard spray cleaner, order part# 7031-7002.
- External and wall mount markerboards are also available.

To Order, Specify:

- 1) Product number.
- 2) Finish color.
(TR-W White specification required.)

Nominal Height	Nominal Width	Number	Price
8"(203mm)	18"(457mm)	VZTI-0818-MNN	\$ 343.17
	24"(610mm)	VZTI-0824-MNN	366.47
	30"(762mm)	VZTI-0830-MNN	389.77
	36"(914mm)	VZTI-0836-MNN	413.07
	42"(1067mm)	VZTI-0842-MNN	436.37
	48"(1219mm)	VZTI-0848-MNN	459.67
	54"(1372mm)	VZTI-0854-MNN	482.97
	60"(1524mm)	VZTI-0860-MNN	506.27
	72"(1829mm)	VZTI-0872-MNN	655.49
16"(406mm)	18"(457mm)	VZTI-1618-MNN	\$ 448.69
	24"(610mm)	VZTI-1624-MNN	482.59
	30"(762mm)	VZTI-1630-MNN	516.49
	36"(914mm)	VZTI-1636-MNN	550.39
	42"(1067mm)	VZTI-1642-MNN	584.29
	48"(1219mm)	VZTI-1648-MNN	618.19
	54"(1372mm)	VZTI-1654-MNN	652.09
	60"(1524mm)	VZTI-1660-MNN	685.99
	72"(1829mm)	VZTI-1672-MNN	959.03
24"(610mm)	18"(457mm)	VZTI-2418-MNN	\$ 533.70
	24"(610mm)	VZTI-2424-MNN	585.18
	30"(762mm)	VZTI-2430-MNN	636.66
	36"(914mm)	VZTI-2436-MNN	688.14
	42"(1067mm)	VZTI-2442-MNN	739.62
	48"(1219mm)	VZTI-2448-MNN	791.10
	54"(1372mm)	VZTI-2454-MNN	842.58
	60"(1524mm)	VZTI-2460-MNN	894.06
	72"(1829mm)	VZTI-2472-MNN	1304.88
32"(813mm)	18"(457mm)	VZTI-3218-MNN	\$ 605.33
	24"(610mm)	VZTI-3224-MNN	664.99
	30"(762mm)	VZTI-3230-MNN	724.65
	36"(914mm)	VZTI-3236-MNN	784.31
	42"(1067mm)	VZTI-3242-MNN	843.97
	48"(1219mm)	VZTI-3248-MNN	903.63
	54"(1372mm)	VZTI-3254-MNN	963.29
	60"(1524mm)	VZTI-3260-MNN	1022.95
	72"(1829mm)	VZTI-3272-MNN	1552.75

Tiles - Full Panel, Connections and Stack Frame

Slat

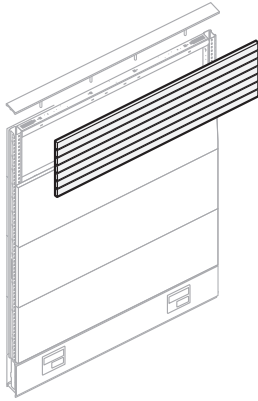

VZTI-JNN
Class BC

Unique Features

- Slat tiles may not span frames.
- External and wall mount slat tiles also available.
- Belong work tools or JumpStuff tools may be used.
- 8"(203mm)H technology tiles not available.

To Order, Specify:

1) Product number, including:

1 Technology Port Option:

- N** No Technology Access
- L** Left-Hand Port (add **\$92.70** list)
- R** Right-Hand Port (add **\$92.70** list)
- 2** Left and Right-Hand Port (add **\$222.51** list)

2) Trim color.

3) Trim color for bezel (if applicable).

Nominal Height	Nominal Width	Number ①	Trim	
			A	B
8"(203mm)	18"(457mm)	VZTI-0818-JNN	\$323.95	\$329.48
	24"(610mm)	VZTI-0824-JNN	356.21	363.56
	30"(762mm)	VZTI-0830-JNN	388.47	397.64
	36"(914mm)	VZTI-0836-JNN	420.73	431.72
	42"(1067mm)	VZTI-0842-JNN	452.99	465.80
	48"(1219mm)	VZTI-0848-JNN	485.25	499.88
	54"(1372mm)	VZTI-0854-JNN	517.51	533.96
	60"(1524mm)	VZTI-0860-JNN	549.77	568.04
	72"(1829mm)	VZTI-0872-JNN	886.47	908.38
16"(406mm)	18"(457mm)	VZTI-1618-JNN	\$475.40	\$486.14
	24"(610mm)	VZTI-1624-J N	525.13	540.17
	30"(762mm)	VZTI-1630-J N	574.90	594.24
	36"(914mm)	VZTI-1636-J N	624.67	648.31
	42"(1067mm)	VZTI-1642-J N	674.42	702.36
	48"(1219mm)	VZTI-1648-J N	724.20	756.44
	54"(1372mm)	VZTI-1654-J N	773.96	810.50
	60"(1524mm)	VZTI-1660-J N	823.68	864.52
	72"(1829mm)	VZTI-1672-J N	1127.06	1176.50

Tiles - Full Panel, Connections and Stack Frame

Open Frame

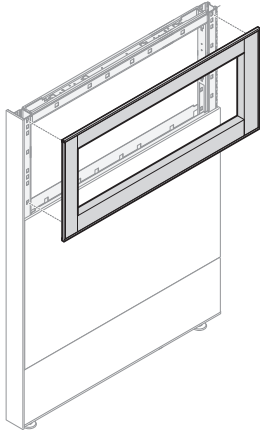

VZTI-ONN
Class BC

Unique Features

- Tiles designed to be used in pairs - one on each side of frame; separately specify second tile.
- When tile is used in top position, separately specify Glass Tile/Open Frame Hardware Kit.
- Not to be used in raceway location or in spanning conditions.

To Order, Specify:

- 1) Product number.
- 2) Trim color.

Nominal Height	Nominal Width	Number	Trim	
			A	B
16"(406mm)	18"(457mm)	VZTI-1618-ONN	\$346.32	\$356.70
	24"(610mm)	VZTI-1624-ONN	369.32	383.84
	30"(762mm)	VZTI-1630-ONN	392.32	410.98
	36"(914mm)	VZTI-1636-ONN	415.32	438.12
	42"(1067mm)	VZTI-1642-ONN	438.32	465.26
	48"(1219mm)	VZTI-1648-ONN	495.36	526.44
	54"(1372mm)	VZTI-1654-ONN	518.36	553.58
	60"(1524mm)	VZTI-1660-ONN	541.36	580.72
	72"(1829mm)	VZTI-1672-ONN	737.58	785.22

Tiles - Full Panel, Connections and Stack Frame

Glass

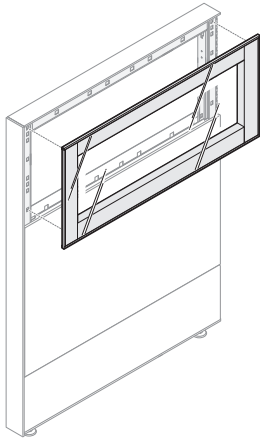

VZTI-YNN
Class BC

Unique Features

- Tiles designed to be used in pairs - one on each side of frame; separately specify second tile.
- When tile is used in top position, separately specify Glass Tile/Open Frame Hardware Kit.
- Not to be used in raceway location or in spanning conditions.

To Order, Specify:

- 1) Product number.
- 2) Trim color.
- 3) Glass option.
Grade A:
 1C = Clear glass
Grade C:
 E21 = Satin Etch

Nominal Height	Nominal Width	Number	Trim A Glass		Trim B Glass	
			A	C	A	C
16"(406mm)	18"(457mm)	VZTI-1618-YNN	\$ 699.55	\$ 838.55	\$ 709.94	\$ 848.94
	24"(610mm)	VZTI-1624-YNN	739.39	894.35	753.88	908.84
	30"(762mm)	VZTI-1630-YNN	779.23	950.15	797.82	968.74
	36"(914mm)	VZTI-1636-YNN	819.07	1005.95	841.76	1028.64
	42"(1067mm)	VZTI-1642-YNN	899.96	1102.80	926.75	1129.59
	48"(1219mm)	VZTI-1648-YNN	939.80	1158.60	970.69	1189.49
	54"(1372mm)	VZTI-1654-YNN	979.64	1214.40	1014.63	1249.39
	60"(1524mm)	VZTI-1660-YNN	1019.48	1270.20	1058.57	1309.29
	72"(1829mm)	VZTI-1672-YNN	1222.33	1504.97	1269.62	1552.26

Hardware Kit — Glass Tile/Open Frame Tile (10 bolts/nuts)

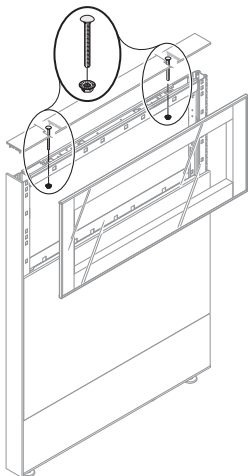

VZTI
Class BC

Features

- Includes attachment hardware designed to be used with Glass Tile or Open Frame Tile in top position.
- Each kit supplies hardware for five Glass Tiles or Open Frame Tiles.
- Compatible for use with full profile aluminum trim, wood trim and thin profile steel trim.
- Not for use with Work Rail top cap.

To Order, Specify:

- 1) Product number.
(No finish specification required.)

Number	Price
VZTI-0000	\$38.11

Compose Echo Integrated Slotted Accessory Tile

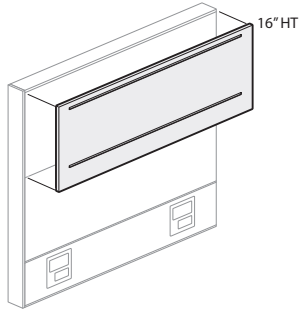

VZTI-ANN

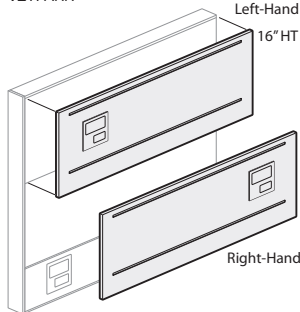

VZTI-A_N

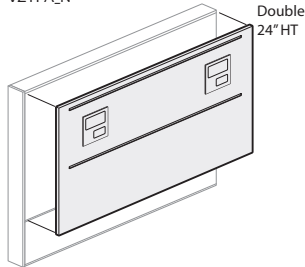

VZTI-ADN
Class TRO

Features

- Includes one slotted tile with integrated backer, two slots, attachment brackets and utility bezel(s) if applicable.
- Compose Echo Accessory Ledge, Belong work tools or Jump Stuff slat tile tools can be used with Slotted Accessory Tile.

Specification Tips

- Tile width to be the same as the Full Panel Frame or Stack Frame; may not span frames.
- Tiles must be placed at appropriate height to align with power access location.
- Power can be routed horizontally at raceway, beltline and below worksurface locations.
 - Capability to route power at below worksurface height requires it to be specified with Full Panel Frame with Below Worksurface Power.
- **Receptacle and data blank plates must be specified separately.**
- **Aligner/Light Blocks are required and separately specified based upon tile configuration.**
- Concealed base feed cannot be used with Slotted Accessory tile to floor applications.
- 18”(457mm)W tile will not accommodate 14”(356mm) or 28”(711mm)W Compose Echo Ledge.
- 24”(610mm)W and 30”(762mm)W will not accommodate a 28”(711mm)W Compose Echo Ledge.
- Vertical panel frame face dimensions:
 - Panel frame/non-raceway cover = frame height minus 2”(51mm)
 - Panel frame/with raceway cover = frame height minus 10”(254mm)
- Refer to Specification Guide for Planning with Tiles and Aligner/Light Blocks.

To Order, Specify:

- 1) Product number.
 - 1 Technology Port Option:**
 - N** No Technology Access
 - L** Left-Hand Port (add **\$38.15** list)
 - R** Right-Hand Port (add **\$38.15** list)
 - D** Left and Right-Hand Port (add **\$70.85** list)
- 2) Tile trim color.
- 3) Trim color for bezel (if applicable).

Height	Width	Number ①	Trim	
			A	B
16”(406mm)	18”(457mm)	VZTI-1618-ANN	\$436.00	\$ 446.90
	24”(610mm)	VZTI-1624-A ■ N	464.34	477.42
	30”(762mm)	VZTI-1630-A ■ N	492.68	507.94
	36”(914mm)	VZTI-1636-A ■ N	521.02	538.46
	42”(1067mm)	VZTI-1642-A ■ N	549.36	568.98
	48”(1219mm)	VZTI-1648-A ■ N	577.70	599.50
	54”(1372mm)	VZTI-1654-A ■ N	606.04	630.02
	60”(1524mm)	VZTI-1660-A ■ N	634.38	660.54
24”(610mm)	72”(1829mm)	VZTI-1672-A ■ N	1078.01	1108.53
	18”(457mm)	VZTI-2418-ANN	\$506.85	\$ 523.20
	24”(610mm)	VZTI-2424-A ■ N	562.44	580.97
	30”(762mm)	VZTI-2430-A ■ N	618.03	638.74
	36”(914mm)	VZTI-2436-A ■ N	673.62	696.51
	42”(1067mm)	VZTI-2442-A ■ N	729.21	754.28
	48”(1219mm)	VZTI-2448-A ■ N	784.80	812.05
	54”(1372mm)	VZTI-2454-A ■ N	840.39	869.82
	60”(1524mm)	VZTI-2460-A ■ N	895.98	927.59
	72”(1829mm)	VZTI-2472-A ■ N	1612.11	1648.08

Compose Echo Accessory Ledge

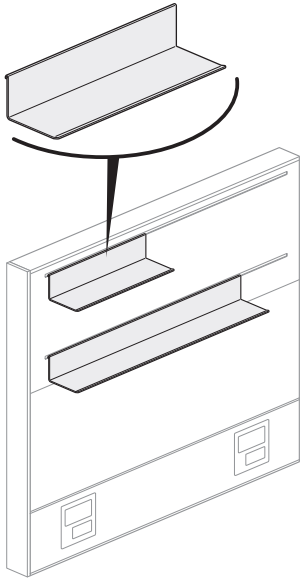

Features

- Includes one shelf.
- Mounts on Slotted Accessory Tile and Belong.

Specification Tips

- Weight capacity
 - 15"(381mm) Five pounds
 - 20"(508mm) Ten pounds

To Order, Specify:

- 1) Product number.
- 2) Trim color.

ATSP
Class TRO

Depth	Height	Width	Number	Trim	
				A	B
5"(127mm)	3.75"(95mm)	14"(356mm)	ATSP-0514-P	\$62.35	\$69.96
		28"(711mm)	ATSP-0528-P	80.69	92.08

External Mount Tiles — Full Panel and Connections

Slat, 16" External Mount

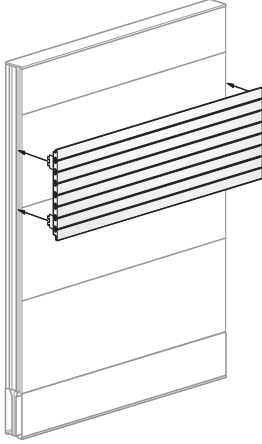

KZPY-16
Class CA

Features

- Includes slat tile attachment brackets.
- Belong work tools or JumpStuff tools may be used.

Specification Tip

- To be installed in panel frame slots on same width panel, a combination of panels equal to tile width or wall track.

To Order, Specify:

- 1) Product number.
- 2) Trim color.

Nominal Height	Nominal Width	Number	Trim A	B
16"(406mm)	24"(610mm)	KZPY-1624	\$422.53	\$ 461.56
	30"(762mm)	KZPY-1630	459.85	498.88
	36"(914mm)	KZPY-1636	497.17	536.20
	42"(1067mm)	KZPY-1642	534.49	573.52
	48"(1219mm)	KZPY-1648	578.03	617.06
	54"(1372mm)	KZPY-1654	609.13	648.16
	60"(1524mm)	KZPY-1660	646.45	685.48
	72"(1829mm)	KZPY-1672	892.91	931.94

Tackboard, External Mount

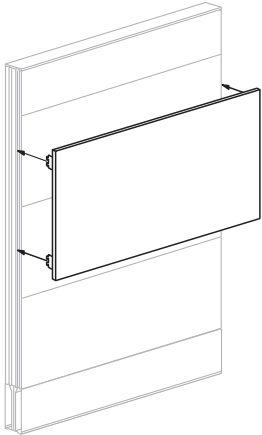

KZAF
Class CA

Feature

- Includes one fabric covered tackboard with attachment brackets.

Specification Tips

- To be installed in panel frame slots on same width panel, a combination of panels equal to tile width or wall track.
- Can be mounted flush to Compose wall track by modifying attachment brackets in field.
- **When 72"(1829mm)W tackboards are specified, fabric will be railroaded. Please refer to surfaces.haworth.com for railroad codes of available fabrics.**
- For aesthetic reasons, consider specifying tackboards less than 72"(1829mm)W with railroad fabric if located adjacent to a tackboard which requires railroaded fabric.

To Order, Specify:

- 1) Product number.
- 2) Fabric surface and color.

Nominal Height	Nominal Width	Number	Fabric					
			A	B	C	E	F	G
16"(406mm)	24"(610mm)	KZAF-1624	\$ 341.82	\$ 357.34	\$359.58	\$364.56	\$445.43	\$ 475.06
	30"(762mm)	KZAF-1630	358.68	377.02	382.38	393.54	478.49	510.22
	36"(914mm)	KZAF-1636	375.54	396.70	405.18	422.52	511.55	545.38
	42"(1067mm)	KZAF-1642	392.40	416.38	427.98	451.50	544.61	580.54
	48"(1219mm)	KZAF-1648	409.26	436.06	450.78	480.48	577.67	615.70
	54"(1372mm)	KZAF-1654	426.12	455.74	473.58	509.46	610.73	650.86
	60"(1524mm)	KZAF-1660	492.98	525.42	546.38	588.44	693.79	736.02
	72"(1829mm)	KZAF-1672	706.53	744.61	771.81	826.23	939.74	986.17

External Mount Tiles — Full Panel and Connections

Markerboard, External Mount

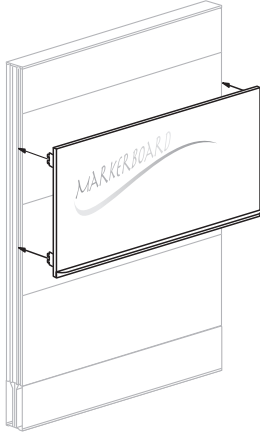

KZAM
Class CA

Features

- Non-magnetic white laminate erasable writing surface with tray and mounting brackets.
- Tray is standard in charcoal and edge is standard in white finish color.
- Markers and eraser are not included.
- Shipped assembled.

Specification Tips

- Installs in panel connector slots on same width panel or multiple width panels, equal to markerboard width.
- **The following products are recommended to maintain the markerboard appearance:**
 - Dry erase marker kit (includes holder, six markers and eraser), order part# 7062-8001.
 - Markerboard cleaner and conditioner, order part# 7031-7001.
 - Markerboard spray cleaner, order part# 7031-7002.

To Order, Specify:

- 1) Product number.
(No finish specification required).

Nominal Height	Nominal Width	Number	Price
16" (406mm)	24" (610mm)	KZAM-1624	\$ 435.15
	30" (762mm)	KZAM-1630	461.43
	36" (914mm)	KZAM-1636	487.71
	42" (1067mm)	KZAM-1642	513.99
	48" (1219mm)	KZAM-1648	540.27
	54" (1372mm)	KZAM-1654	566.55
	60" (1524mm)	KZAM-1660	592.83
24" (610mm)	72" (1829mm)	KZAM-1672	879.71
	24" (610mm)	KZAM-2424	\$ 582.05
	30" (762mm)	KZAM-2430	608.33
	36" (914mm)	KZAM-2436	634.61
	42" (1067mm)	KZAM-2442	660.89
	48" (1219mm)	KZAM-2448	687.17
	54" (1372mm)	KZAM-2454	713.45
32" (813mm)	60" (1524mm)	KZAM-2460	739.73
	72" (1829mm)	KZAM-2472	1143.77
	24" (610mm)	KZAM-3224	\$ 728.95
	30" (762mm)	KZAM-3230	755.23
	36" (914mm)	KZAM-3236	781.51
	42" (1067mm)	KZAM-3242	807.79
	48" (1219mm)	KZAM-3248	834.07
32" (813mm)	54" (1372mm)	KZAM-3254	860.35
	60" (1524mm)	KZAM-3260	886.63
	72" (1829mm)	KZAM-3272	1407.83

Tiles - Beam



VZTI-FNN

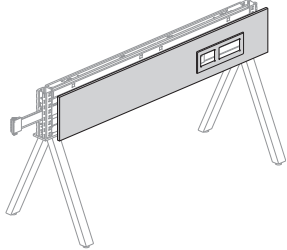

VZTI-FEN

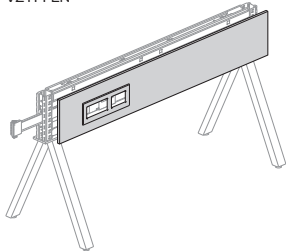

VZTI-FWN

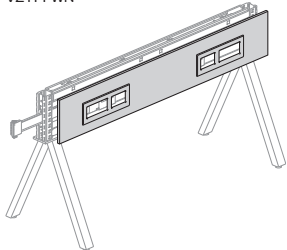

VZTI-FDN

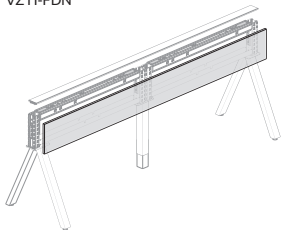

VZTI-FNN

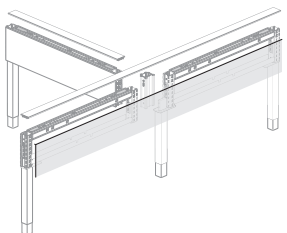

VZTI-FNS
Class BC

Common Features

- Includes one tile, attachment clips and utility bezel(s) if applicable.
- Actual height is nominal height less .130"(3mm).
- Actual width is nominal width less .400"(10mm).
- Frame allows for independent planning options on each side; tile type may be the same or different per side.
- Separately specified top trim is required.
- Tiles without technology access may be same width as a single frame or may span two in-line frames. Tiles with technology access may NOT span frames.

Specification Tips

Technology Tiles:

- For use with 3- or 4-circuit powered frame.
- 18"(457mm)-24"(610mm)W tiles not available with technology access.
- 30"(762mm)W tiles available with single (left or right-hand) technology access only.
- Technology Tiles may not span frames.
- Technology Tiles for Beam are specifically designed for the Beam frame. Full Panel or Connections Technology Tiles are not compatible with Beam frame.
- Power can only be routed horizontally below worksurface.
- A left-hand and right-hand ported tile may be specified for a back-to-back ported application.
- The following power and communication items must be separately specified:
 - 3- or 4-circuit receptacle or receptacle blank cover (each side specified separately).
 - Data faceplate supplied by outside vendor or data blank cover. (VZAD-0000-B)
 - Communication Data Bracket (VZAJ-0000) (one for every utility bezel)

In-Line Spanning Tile:

- Tiles 36"(914mm)W or greater may span a maximum of two frames.
- Opposite side of spanning tile may be same width as each frame or another spanning tile.
- In a spanning tile application top trim may span both frames or may be same width as each frame.

3-Way Intersection Spanning Tile:

- Tile width equals the sum of two separately specified panel or stack frame plus 3" for 3-Way panel intersection.
- Opposite side of frames require separately specified tiles.
- Separately specified spanning top trim is required; not for use with top trim same width as individual frames.
- Separately specified 3-Way Intersection - Spanning Tile Corner Blocks (VZCT-0800-NSBN) are required.

Order Specification

1) Product number, including:

1 Technology Port Option:

- N** No Technology Access
- W** Left-Hand Port
- E** Right-Hand Port
- D** Left and Right-Hand Port

2) Surface color/finish.

3) Bezel trim color (if applicable).

- TR-R Beige
- TR-AK Chalk
- TR-K Charcoal
- TR-J Graphite
- TR-G Gray Tone
- TR-TW Plaster
- TR-AA Putty
- TR-E Smoke

Tiles - Beam

Fabric

Unique Features

- Fabric tiles are tackable.
- Fabric tiles may be field ported.
- **Tiles greater than 60"(1524mm)W, fabric will be railroded (RR). Please refer to surfaces.haworth.com for available fabric codes.**
- For aesthetic reasons, consider specifying tiles 60"(1524mm)W or less with railroded fabric if located adjacent to a tile which requires railroded fabric.

To Order, Specify:

- Product number, including:
 - 1 Technology Port Option:**
 - N** No Technology Access
 - W** Left-Hand Port (add **\$88.70** list)
 - E** Right-Hand Port (add **\$88.70** list)
 - D** Left and Right-Hand Port (add **\$212.90** list)
- Fabric color.
- Trim color for bezel (if applicable).

Nominal Height	Nominal Width	Number ①	Fabric						
			A	B	C	D	E	F	G
Individual and In-Line Spanning Tiles									
8"(203mm)	18"(457mm)	VZTI-0818-FNN	\$ 91.43	\$104.50	\$ 118.85	\$ 134.52	\$ 150.20	\$ 171.09	\$ 184.17
	24"(610mm)	VZTI-0824-FNN	98.45	112.58	128.11	145.06	162.03	184.62	198.76
	30"(762mm)	VZTI-0830-F ■ N	105.45	120.66	137.35	155.60	173.85	198.14	213.34
	36"(914mm)	VZTI-0836-F ■ N	117.46	133.74	151.61	171.13	190.68	216.67	232.92
	42"(1067mm)	VZTI-0842-F ■ N	119.48	136.81	155.86	176.67	197.50	225.20	242.51
	48"(1219mm)	VZTI-0848-F ■ N	126.48	144.90	165.11	187.21	209.32	238.72	257.10
	54"(1372mm)	VZTI-0854-F ■ N	133.50	152.97	174.36	197.75	221.15	252.25	271.68
	60"(1524mm)	VZTI-0860-F ■ N	140.51	161.04	183.61	208.28	232.97	265.78	286.26
	72"(1829mm)	VZTI-0872-F ■ N	206.36	229.03	253.94	281.19	308.45	344.66	367.26
Spanning 3-Way Intersection Tiles									
8"(203mm)	39"(991mm)	VZTI-0839-FNS	\$330.58	\$347.38	\$365.84	\$ 386.01	\$406.20	\$433.05	\$449.82
	45"(1143mm)	VZTI-0845-FNS	337.59	355.46	375.09	396.55	418.02	446.56	464.41
	51"(1295mm)	VZTI-0851-FNS	344.61	363.54	384.35	407.09	429.85	460.10	479.00
	57"(1448mm)	VZTI-0857-FNS	351.61	371.62	393.59	417.63	441.67	473.62	493.58
	63"(1600mm)	VZTI-0863-FNS	358.63	379.69	402.85	428.17	453.50	487.16	508.16
	69"(1753mm)	VZTI-0869-FNS	365.64	387.78	412.10	438.71	465.32	500.67	522.75

Tiles - Beam

Laminate

Unique Features

- High Pressure Laminate (HPL) tile has 1mm edgeband.
- 8"(203mm)H laminate tiles may not be field ported.

Notes: Wood grain laminate grain direction is vertical.
Wood grain not available on 72"(1829mm)W (standard product).



Wood Grain Laminate

To Order, Specify:

1) Product number, including:

1 Technology Port Option:

- N** No Technology Access
- W** Left-Hand Port (add **\$87.40** list)
- E** Right-Hand Port (add **\$87.40** list)
- D** Left and Right-Hand Port (add **\$208.28** list)

2) Laminate surface color.

3) Edgeband color.

4) Trim color for bezel (if applicable).

Nominal Height	Nominal Width	Number 1	HPL	
			A	B
Individual Tiles				
8"(203mm)	18"(457mm)	VZTI-0818-DNN	\$ 238.63	\$ 250.13
	24"(610mm)	VZTI-0824-DNN	282.90	295.94
	30"(762mm)	VZTI-0830-D N	297.17	311.74
	36"(914mm)	VZTI-0836-D N	311.44	327.55
	42"(1067mm)	VZTI-0842-D N	315.71	333.36
	48"(1219mm)	VZTI-0848-D N	334.98	354.16
	54"(1372mm)	VZTI-0854-D N	354.25	374.97
	60"(1524mm)	VZTI-0860-D N	373.52	395.78
	72"(1829mm)	VZTI-0872-D N	480.86	N/A
Spanning In-Line Tiles				
8"(203mm)	48"(1219mm)	VZTI-0848-DNS	\$ 616.92	\$ 636.10
	54"(1372mm)	VZTI-0854-DNS	636.19	656.91
	60"(1524mm)	VZTI-0860-DNS	655.46	677.72
	66"(1676mm)	VZTI-0866-DNS	674.73	N/A
	72"(1829mm)	VZTI-0872-DNS	762.80	N/A
	78"(1981mm)	VZTI-0878-DNS	782.07	N/A
	84"(2134mm)	VZTI-0884-DNS	801.34	N/A
	90"(2286mm)	VZTI-0890-DNS	820.61	N/A
	96"(2438mm)	VZTI-0896-DNS	839.88	N/A
Spanning 3-Way Intersection Tiles				
8"(203mm)	39"(991mm)	VZTI-0839-DNS	\$ 588.01	\$604.89
	45"(1143mm)	VZTI-0845-DNS	607.28	625.70
	51"(1295mm)	VZTI-0851-DNS	626.56	646.51
	57"(1448mm)	VZTI-0857-DNS	645.83	667.31
	63"(1600mm)	VZTI-0863-DNS	665.10	N/A
	69"(1753mm)	VZTI-0869-DNS	684.36	N/A
	75"(1905mm)	VZTI-0875-DNS	772.44	N/A
	81"(2057mm)	VZTI-0881-DNS	791.71	N/A
	93"(2362mm)	VZTI-0893-DNS	830.24	N/A
	99"(2515mm)	VZTI-0899-DNS	849.51	N/A

Tiles - Beam

Steel

Unique Features

- 8"(203mm)H steel tiles may not be field ported.
- Powdercoat finish.

To Order, Specify:

1) Product number, including:

1 Technology Port Option:

- N** No Technology Access
- W** Left-Hand Port (add **\$87.40** list)
- E** Right-Hand Port (add **\$87.40** list)
- D** Left and Right-Hand Port (add **\$209.75** list)

2) Trim color.

3) Trim color for bezel (if applicable).

Nominal Height	Nominal Width	Number 1	Trim	
			A	B
Individual Tiles				
8"(203mm)	18"(457mm)	VZTI-0818-PNN	\$ 153.35	\$ 158.62
	24"(610mm)	VZTI-0824-PNN	163.39	170.42
	30"(762mm)	VZTI-0830-P N	173.43	182.22
	36"(914mm)	VZTI-0836-P N	183.47	194.02
	42"(1067mm)	VZTI-0842-P N	193.51	205.82
	48"(1219mm)	VZTI-0848-P N	203.55	217.62
	54"(1372mm)	VZTI-0854-P N	213.59	229.42
	60"(1524mm)	VZTI-0860-P N	223.63	241.22
	72"(1829mm)	VZTI-0872-P N	283.29	304.40
Spanning In-Line Tiles				
8"(203mm)	48"(1219mm)	VZTI-0848-PNS	\$333.30	\$ 347.37
	54"(1372mm)	VZTI-0854-PNS	343.34	359.17
	60"(1524mm)	VZTI-0860-PNS	353.38	370.97
	66"(1676mm)	VZTI-0866-PNS	363.42	382.77
	72"(1829mm)	VZTI-0872-PNS	373.46	394.57
	78"(1981mm)	VZTI-0878-PNS	383.50	406.37
Spanning 3-Way Intersection Tiles				
8"(203mm)	39"(991mm)	VZTI-0839-PNS	\$ 318.24	\$ 329.67
	45"(1143mm)	VZTI-0845-PNS	328.28	341.47
	51"(1295mm)	VZTI-0851-PNS	338.32	353.27
	57"(1448mm)	VZTI-0857-PNS	348.36	365.07
	63"(1600mm)	VZTI-0863-PNS	358.40	376.87
	69"(1753mm)	VZTI-0869-PNS	368.44	388.67
	75"(1905mm)	VZTI-0875-PNS	378.48	400.47

Tiles - Beam

Wood

Unique Features

- 8"(203mm)H wood tiles may not be field ported.
- Low gloss finish for double-cut veneer wood tiles.
- Standard gloss finish for natural wood tiles.



Double-Cut Veneer
Horizontal grain direction



Natural Veneer
Vertical grain direction

To Order, Specify:

1) Product number, including:

1 Technology Port Option:

N No Technology Access

W Left-Hand Port (add **\$87.40** list)

E Right-Hand Port (add **\$87.40** list)

D Left and Right-Hand Port (add **\$209.75** list)

2) Wood finish color.

3) Trim color for bezel (if applicable).

Nominal Height	Nominal Width	Number 1	Wood	
			A	B
Individual Tiles				
8"(203mm)	18"(457mm)	VZTI-0818-WNN	\$ 644.96	\$ 754.94
	24"(610mm)	VZTI-0824-WNN	669.44	782.90
	30"(762mm)	VZTI-0830-W N	693.92	810.86
	36"(914mm)	VZTI-0836-W N	718.40	838.82
	42"(1067mm)	VZTI-0842-W N	742.88	866.78
	48"(1219mm)	VZTI-0848-W N	767.36	894.74
	54"(1372mm)	VZTI-0854-W N	791.84	922.70
	60"(1524mm)	VZTI-0860-W N	816.32	950.66
	72"(1829mm)	VZTI-0872-W N	989.89	1131.19
Spanning In-Line Tiles				
8"(203mm)	48"(1219mm)	VZTI-0848-WNS	\$ 831.14	\$ 958.52
	54"(1372mm)	VZTI-0854-WNS	855.62	986.48
	60"(1524mm)	VZTI-0860-WNS	880.10	1014.44
	66"(1676mm)	VZTI-0866-WNS	925.84	1063.66
	72"(1829mm)	VZTI-0872-WNS	950.32	1091.62
	78"(1981mm)	VZTI-0878-WNS	974.80	1119.58
	84"(2134mm)	VZTI-0884-WNS	1020.54	1168.80
	90"(2286mm)	VZTI-0890-WNS	1045.02	1196.76
	96"(2438mm)	VZTI-0896-WNS	1069.50	1224.72
Spanning 3-Way Intersection Tiles				
8"(203mm)	39"(991mm)	VZTI-0839-WNS	\$ 773.16	\$ 895.32
	45"(1143mm)	VZTI-0845-WNS	818.90	944.54
	51"(1295mm)	VZTI-0851-WNS	843.38	972.50
	57"(1448mm)	VZTI-0857-WNS	867.86	1000.46
	63"(1600mm)	VZTI-0863-WNS	913.60	1049.68
	69"(1753mm)	VZTI-0869-WNS	938.08	1077.64
	75"(1905mm)	VZTI-0875-WNS	962.56	1105.60
	81"(2057mm)	VZTI-0881-WNS	1008.30	1154.82
	93"(2362mm)	VZTI-0893-WNS	1057.26	1210.74
	99"(2515mm)	VZTI-0899-WNS	1103.00	1259.96

Panel Accessories

Stack Frame

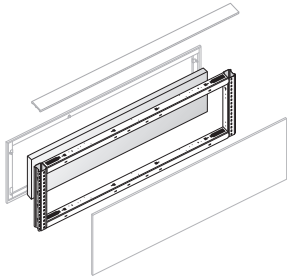

VZFS
Class BC

Features

- Includes frame assembly and attachment hardware.
- High acoustical option available with separately specified High Acoustical Inserts.

Specification Tips

- Any tile type can be used to face open stack frames.
- Relocate top trim from the panel frame to top of stack frame.
- When adding stack frame to panel frame, order vertical trim cover to match overall height of panel and stack frame.
- Stack one or two high; first stack is load bearing.
- **One corner block assembly per intersection (2-, 3-, or 4-way) will be required (separately specified) for each level of stacks (stack frame or glass stack) at the intersection.**
- Not for use on glass panels or glass stacks.
- Overall height including panel frame and stack frame(s) may not exceed 90"(2286mm).
- Black finish.
- To route power and data horizontally through the stack frame add a U to the end of the catalog number. Example VZFS-1636-RU (add **\$109.46** list).

To Order, Specify:

- 1) Product number.
(No color specification required.)

Nominal Height	Nominal Width	Number	Price
16"(406mm)	18"(457mm)	VZFS-1618-R	\$362.85
	24"(610mm)	VZFS-1624-R	400.49
	30"(762mm)	VZFS-1630-R	438.13
	36"(914mm)	VZFS-1636-R	475.77
	42"(1067mm)	VZFS-1642-R	513.41
	48"(1219mm)	VZFS-1648-R	551.05
	54"(1372mm)	VZFS-1654-R	588.69
	60"(1524mm)	VZFS-1660-R	626.33
	72"(1829mm)	VZFS-1672-R	863.17

Panel Accessories

Glass Stack

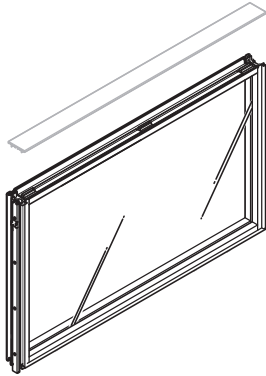

VZGS-1618-1
Class BC

Features

- Includes frame assembly with glass and mounting hardware.
- Glass stack is preassembled.

Specification Tips

- Relocate top trim from the panel frame to top of glass stack.
- Not for use with Work Rail Top Trim.
- When adding glass stack to panel frame, order vertical trim cover to match overall height of panel and glass stack.
- Glass stacks can match individual panel width or span two panel frames.
- **One corner block assembly per intersection (2-, 3-, or 4-way) will be required (separately specified) for each level of stacks (stack frame or glass stack) at the intersection.**
- Non-load bearing; will not accept components or countertop.
- Overall height including panel frame, stack frame and glass stack may not exceed 90"(2286mm).
- Separately specify Tie Bracket Kit if using Compose Glass Stack adjacent to drywall.
- May be used in Slider Door application. Refer to Specification Guide.
- Separately specify glass to glass connector for a 2H glass stack application. Refer to Specification Guide.
- Separately specify glass top trim clip kit when specifying steel top trim on frame that spans over a glass stack or glass panel.
- Patterned glasses VM and CM available in widths up to 60"(1524mm).

To Order, Specify:

- 1) Product number.
- 2) Trim color for frame.
- 4) Glass option.

Grade A:

1C = Clear glass

Grade C:

E21 = Satin Etch

Grade D:

1E = Frosted acrylic ^(M)

VM = Patterned glass

CM = Patterned glass

^(M) Items marked with this symbol available as GSA open market.

Nominal Height	Nominal Width	Number	Trim A Glass			Trim B Glass		
			A	C	D	A	C	D
16"(406mm)	18"(457mm)	VZGS-1618-1	\$ 917.32	\$1108.35	\$1479.38	\$935.81	\$1126.84	\$1497.87
	24"(610mm)	VZGS-1624-1	1019.92	1287.87	1667.60	1040.09	1308.04	1687.77
	30"(762mm)	VZGS-1630-1	1122.52	1467.39	1855.82	1144.37	1489.24	1877.67
	36"(914mm)	VZGS-1636-1	1225.12	1646.91	2044.04	1248.65	1670.44	2067.57
	42"(1067mm)	VZGS-1642-1	1327.72	1826.43	2232.26	1352.93	1851.64	2257.47
	48"(1219mm)	VZGS-1648-1	1430.32	2005.95	2420.48	1457.21	2032.84	2447.37
	54"(1372mm)	VZGS-1654-1	1532.92	2185.47	2608.70	1561.49	2214.04	2637.27
	60"(1524mm)	VZGS-1660-1	1635.52	2364.99	2796.92	1665.77	2395.24	2827.17
	66"(1676mm)	VZGS-1666-1	1956.58	2762.97	3203.60	1988.51	2794.90	3235.53
	72"(1829mm)	VZGS-1672-1	2059.18	2942.49	3391.82	2092.79	2976.10	3425.43
	78"(1981mm)	VZGS-1678-1	2161.78	3122.01	3580.04	2197.07	3157.30	3615.33
	84"(2134mm)	VZGS-1684-1	2264.38	3301.53	3768.26	2301.35	3338.50	3805.23
90"(2286mm)	VZGS-1690-1	2366.98	3481.05	3956.48	2405.63	3519.70	3995.13	
96"(2438mm)	VZGS-1696-1	2469.58	3660.57	4144.70	2509.91	3700.90	4185.03	
24"(610mm)	18"(457mm)	VZGS-2418-1	\$ 1259.55	\$ 1518.76	\$ 2134.95	\$ 1278.04	\$ 1537.25	\$ 2153.44
	24"(610mm)	VZGS-2424-1	1362.15	1698.28	2323.17	1382.32	1718.45	2343.34
	30"(762mm)	VZGS-2430-1	1464.75	1877.80	2511.39	1486.60	1899.65	2533.24
	36"(914mm)	VZGS-2436-1	1567.35	2057.32	2699.61	1590.88	2080.85	2723.14
	42"(1067mm)	VZGS-2442-1	1669.95	2236.84	2887.83	1695.16	2262.05	2913.04
	48"(1219mm)	VZGS-2448-1	1772.55	2416.36	3076.05	1799.44	2443.25	3102.94
	54"(1372mm)	VZGS-2454-1	2147.31	2868.04	3536.43	2175.88	2896.61	3565.00
	60"(1524mm)	VZGS-2460-1	2295.27	3092.92	3770.01	2325.52	3123.17	3800.26
	66"(1676mm)	VZGS-2466-1	2661.69	3536.26	4222.05	2693.62	3568.19	4253.98
	72"(1829mm)	VZGS-2472-1	2809.65	3761.14	4455.63	2843.26	3794.75	4489.24
	78"(1981mm)	VZGS-2478-1	2957.61	3986.02	4689.21	2992.90	4021.31	4724.50
	84"(2134mm)	VZGS-2484-1	3105.57	4210.90	4922.79	3142.54	4247.87	4959.76
90"(2286mm)	VZGS-2490-1	3253.53	4435.78	5156.37	3292.18	4474.43	5195.02	
96"(2438mm)	VZGS-2496-1	3401.49	4660.66	5389.95	3441.82	4700.99	5430.28	

Panel Accessories

Frameless Glass and Rail Kit

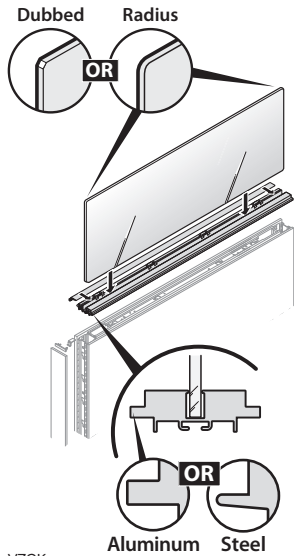

VZGK
Class BC

Features

- Includes one bottom rail with or without notches and one 0.25"(6mm) or 0.5"(13mm) thick frameless glass insert.
- 0.25"(6mm) thick insert for use with Steel or Aluminum trim options. 0.5"(13mm) thick insert for use with Aluminum trim option only.
- Frameless glass insert standard with beveled edges on top and sides if glass or acrylic. Bottom corners will be dubbed. Top corners may be dubbed or radius.
- Mounting Options:
(S) - Same height application, in-line.
(V) - Variable height application, one end.
(D) - Variable height application, both ends.
- Inserts available in Clear Glass (1C) (writable), Satin Etch (E21) and Frosted Acrylic (1E).

Specification Tips

- May be the same width as a single panel or may span a maximum of two full panel frames or stack frames in an in-line panel application or a 90°, 3- or 4-way panel intersection.
- The bottom rail is used in place of top trim.
-Not for use above a glass panel or glass stack.
- **Insert Mounting Option must match the Bottom Rail Mounting Option; Refer to Application Guidelines for exceptions.**
- Bottom Rail End Cap and End-of-Run Trim are application specific; separately specify as needed.
- Product Reconfiguration Note: Installations prior to August 1, 2021 were standard with radius top corners; specify accordingly.

To Order, Specify:

- 1) Product number, including:

1 Mounting Options

- S** Same height/in-line
- V** Variable height/one end (add **\$23.99** list)
- D** Variable height/both ends (add **\$47.94** list)

2 Top Corner Options

- D** Dubbed
- R** Radius (add **\$139.85** list)

- 2) Trim color for rail.

- 3) Insert color.

0.25"(6mm) Glass

1C = Clear Glass

E21 = Satin Etch

1E = Frosted Acrylic

0.50"(12mm) Glass

8C = Clear Glass

E25 = Satin Etch

Nominal Height	Nominal Width	Number	1 2	Trim A			Trim B		
				Clear Glass	Satin Etch	Frosted Acrylic	Clear Glass	Satin Etch	Frosted Acrylic
0.25"(6mm) Thick - Steel Trim									
8"(203mm)	18"(457mm)	VZGK-0818-H	4	\$ 589.72	\$ 791.62	\$ 926.30	\$ 591.32	\$ 793.22	\$ 927.90
	24"(610mm)	VZGK-0824-H	4	678.06	885.58	1024.00	681.28	888.80	1027.22
	30"(762mm)	VZGK-0830-H	4	766.40	979.54	1121.70	771.24	984.38	1126.54
	36"(914mm)	VZGK-0836-H	4	854.74	1073.50	1219.40	861.20	1079.96	1225.86
	39"(991mm)	VZGK-0839-H	4	898.91	1120.48	1268.25	906.18	1127.75	1275.52
	42"(1067mm)	VZGK-0842-H	4	943.08	1167.46	1317.10	951.16	1175.54	1325.18
	45"(1143mm)	VZGK-0845-H	4	987.25	1214.44	1365.95	996.14	1223.33	1374.84
	48"(1219mm)	VZGK-0848-H	4	1031.42	1261.42	1414.80	1041.12	1271.12	1424.50
	51"(1295mm)	VZGK-0851-H	4	1075.59	1308.40	1463.65	1086.10	1318.91	1474.16
	54"(1372mm)	VZGK-0854-H	4	1119.76	1355.38	1512.50	1131.08	1366.70	1523.82
	57"(1448mm)	VZGK-0857-H	4	1163.93	1402.36	1561.35	1176.06	1414.49	1573.48
	60"(1524mm)	VZGK-0860-H	4	1208.10	1449.34	1610.20	1221.04	1462.28	1623.14
	63"(1600mm)	VZGK-0863-H	4	1252.27	1496.32	1659.05	1266.02	1510.07	1672.80
	66"(1676mm)	VZGK-0866-H	4	1296.44	1543.30	1707.90	1311.00	1557.86	1722.46
	69"(1753mm)	VZGK-0869-H	4	1340.61	1590.28	1756.75	1355.98	1605.65	1772.12
	72"(1829mm)	VZGK-0872-H	4	1384.78	1637.26	1805.60	1400.96	1653.44	1821.78
	75"(1905mm)	VZGK-0875-H	4	1428.95	1684.24	1854.45	1445.94	1701.23	1871.44
	78"(1981mm)	VZGK-0878-H	4	1473.12	1731.22	1903.30	1490.92	1749.02	1921.10
	81"(2057mm)	VZGK-0881-H	4	1517.29	1778.20	1952.15	1535.90	1796.81	1970.76
	84"(2134mm)	VZGK-0884-H	4	1561.46	1825.18	2001.00	1580.88	1844.60	2020.42
	87"(2210mm)	VZGK-0887-H	4	1605.63	1872.16	2049.85	1625.86	1892.39	2070.08
	90"(2286mm)	VZGK-0890-H	4	1649.80	1919.14	2098.70	1670.84	1940.18	2119.74
	93"(2362mm)	VZGK-0893-H	4	1693.97	1966.12	2147.55	1715.82	1987.97	2169.40
	96"(2438mm)	VZGK-0896-H	4	1738.14	2013.10	2196.40	1760.80	2035.76	2219.06
	99"(2515mm)	VZGK-0899-H	4	1782.31	2060.08	2245.25	1805.78	2083.55	2268.72
	102"(2591mm)	VZGK-08A2-H	4	1826.48	2107.06	2294.10	1850.76	2131.34	2318.38
	105"(2667mm)	VZGK-08A5-H	4	1870.65	2154.04	2342.95	1895.74	2179.13	2368.04
	108"(2743mm)	VZGK-08A8-H	4	1914.82	2201.02	2391.80	1940.72	2226.92	2417.70
	111"(2819mm)	VZGK-08B1-H	4	1958.99	2248.00	2440.65	1985.70	2274.71	2467.36
	114"(2896mm)	VZGK-08B4-H	4	2003.16	2294.98	2489.50	2030.68	2322.50	2517.02
	117"(2972mm)	VZGK-08B7-H	4	2047.33	2341.96	2538.35	2075.66	2370.29	2566.68
	120"(3048mm)	VZGK-08C0-H	4	2091.50	2388.94	2587.20	2120.64	2418.08	2616.34

Panel Accessories

Nominal Height	Nominal Width	Number ① ②	Trim A			Trim B		
			Clear Glass	Satin Etch	Frosted Acrylic	Clear Glass	Satin Etch	Frosted Acrylic
12"(305mm)	18"(457mm)	VZGK-1218-H 4	\$ 616.78	\$ 827.11	\$ 967.40	\$ 618.38	\$ 828.71	\$ 969.00
	24"(610mm)	VZGK-1224-H 4	714.14	932.90	1078.80	717.36	936.12	1082.02
	30"(762mm)	VZGK-1230-H 4	811.50	1038.69	1190.20	816.34	1043.53	1195.04
	36"(914mm)	VZGK-1236-H 4	908.86	1144.48	1301.60	915.32	1150.94	1308.06
	39"(991mm)	VZGK-1239-H 4	962.05	1203.29	1364.15	969.32	1210.56	1371.42
	42"(1067mm)	VZGK-1242-H 4	1006.22	1250.27	1413.00	1014.30	1258.35	1421.08
	45"(1143mm)	VZGK-1245-H 4	1059.41	1309.08	1475.55	1068.30	1317.97	1484.44
	48"(1219mm)	VZGK-1248-H 4	1103.58	1356.06	1524.40	1113.28	1365.76	1534.10
	51"(1295mm)	VZGK-1251-H 4	1156.77	1414.87	1586.95	1167.28	1425.38	1597.46
	54"(1372mm)	VZGK-1254-H 4	1200.94	1461.85	1635.80	1212.26	1473.17	1647.12
	57"(1448mm)	VZGK-1257-H 4	1254.13	1520.66	1698.35	1266.26	1532.79	1710.48
	60"(1524mm)	VZGK-1260-H 4	1298.30	1567.64	1747.20	1311.24	1580.58	1760.14
	63"(1600mm)	VZGK-1263-H 4	1351.49	1626.45	1809.75	1365.24	1640.20	1823.50
	66"(1676mm)	VZGK-1266-H 4	1395.66	1673.43	1858.60	1410.22	1687.99	1873.16
	69"(1753mm)	VZGK-1269-H 4	1448.85	1732.24	1921.15	1464.22	1747.61	1936.52
	72"(1829mm)	VZGK-1272-H 4	1493.02	1779.22	1970.00	1509.20	1795.40	1986.18
	75"(1905mm)	VZGK-1275-H 4	1546.21	1838.03	2032.55	1563.20	1855.02	2049.54
	78"(1981mm)	VZGK-1278-H 4	1590.38	1885.01	2081.40	1608.18	1902.81	2099.20
	81"(2057mm)	VZGK-1281-H 4	1643.57	1943.82	2143.95	1662.18	1962.43	2162.56
	84"(2134mm)	VZGK-1284-H 4	1687.74	1990.80	2192.80	1707.16	2010.22	2212.22
	87"(2210mm)	VZGK-1287-H 4	1740.93	2049.61	2255.35	1761.16	2069.84	2275.58
	90"(2286mm)	VZGK-1290-H 4	1785.10	2096.59	2304.20	1806.14	2117.63	2325.24
	93"(2362mm)	VZGK-1293-H 4	1838.29	2155.40	2366.75	1860.14	2177.25	2388.60
	96"(2438mm)	VZGK-1296-H 4	1882.46	2202.38	2415.60	1905.12	2225.04	2438.26
	99"(2515mm)	VZGK-1299-H 4	1935.65	2261.19	2478.15	1959.12	2284.66	2501.62
	102"(2591mm)	VZGK-12A2-H 4	1979.82	2308.17	2527.00	2004.10	2332.45	2551.28
	105"(2667mm)	VZGK-12A5-H 4	2033.01	2366.98	2589.55	2058.10	2392.07	2614.64
	108"(2743mm)	VZGK-12A8-H 4	2077.18	2413.96	2638.40	2103.08	2439.86	2664.30
	111"(2819mm)	VZGK-12B1-H 4	2130.37	2472.77	2700.95	2157.08	2499.48	2727.66
	114"(2896mm)	VZGK-12B4-H 4	2174.54	2519.75	2749.80	2202.06	2547.27	2777.32
	117"(2972mm)	VZGK-12B7-H 4	2227.73	2578.56	2812.35	2256.06	2606.89	2840.68
	120"(3048mm)	VZGK-12C0-H 4	2271.90	2625.54	2861.20	2301.04	2654.68	2890.34
16"(406mm)	18"(457mm)	VZGK-1618-H 4	\$ 643.84	\$ 862.60	\$ 1008.50	\$ 645.44	\$ 864.20	\$ 1010.10
	24"(610mm)	VZGK-1624-H 4	750.22	980.22	1133.60	753.44	983.44	1136.82
	30"(762mm)	VZGK-1630-H 4	856.60	1097.84	1258.70	861.44	1102.68	1263.54
	36"(914mm)	VZGK-1636-H 4	962.98	1215.46	1383.80	969.44	1221.92	1390.26
	39"(991mm)	VZGK-1639-H 4	1016.17	1274.27	1446.35	1023.44	1281.54	1453.62
	42"(1067mm)	VZGK-1642-H 4	1069.36	1333.08	1508.90	1077.44	1341.16	1516.98
	45"(1143mm)	VZGK-1645-H 4	1122.55	1391.89	1571.45	1131.44	1400.78	1580.34
	48"(1219mm)	VZGK-1648-H 4	1175.74	1450.70	1634.00	1185.44	1460.40	1643.70
	51"(1295mm)	VZGK-1651-H 4	1228.93	1509.51	1696.55	1239.44	1520.02	1707.06
	54"(1372mm)	VZGK-1654-H 4	1282.12	1568.32	1759.10	1293.44	1579.64	1770.42
	57"(1448mm)	VZGK-1657-H 4	1335.31	1627.13	1821.65	1347.44	1639.26	1833.78
	60"(1524mm)	VZGK-1660-H 4	1388.50	1685.94	1884.20	1401.44	1698.88	1897.14
	63"(1600mm)	VZGK-1663-H 4	1441.69	1744.75	1946.75	1455.44	1758.50	1960.50
	66"(1676mm)	VZGK-1666-H 4	1494.88	1803.56	2009.30	1509.44	1818.12	2023.86
	69"(1753mm)	VZGK-1669-H 4	1548.07	1862.37	2071.85	1563.44	1877.74	2087.22
	72"(1829mm)	VZGK-1672-H 4	1601.26	1921.18	2134.40	1617.44	1937.36	2150.58
	75"(1905mm)	VZGK-1675-H 4	1654.45	1979.99	2196.95	1671.44	1996.98	2213.94
	78"(1981mm)	VZGK-1678-H 4	1707.64	2038.80	2259.50	1725.44	2056.60	2277.30
	81"(2057mm)	VZGK-1681-H 4	1760.83	2097.61	2322.05	1779.44	2116.22	2340.66
	84"(2134mm)	VZGK-1684-H 4	1814.02	2156.42	2384.60	1833.44	2175.84	2404.02
	87"(2210mm)	VZGK-1687-H 4	1867.21	2215.23	2447.15	1887.44	2235.46	2467.38
	90"(2286mm)	VZGK-1690-H 4	1920.40	2274.04	2509.70	1941.44	2295.08	2530.74
	93"(2362mm)	VZGK-1693-H 4	1973.59	2332.85	2572.25	1995.44	2354.70	2594.10
	96"(2438mm)	VZGK-1696-H 4	2026.78	2391.66	2634.80	2049.44	2414.32	2657.46
	99"(2515mm)	VZGK-1699-H 4	2079.97	2450.47	2697.35	2103.44	2473.94	2720.82
	102"(2591mm)	VZGK-16A2-H 4	2133.16	2509.28	2759.90	2157.44	2533.56	2784.18
	105"(2667mm)	VZGK-16A5-H 4	2186.35	2568.09	2822.45	2211.44	2593.18	2847.54
	108"(2743mm)	VZGK-16A8-H 4	2239.54	2626.90	2885.00	2265.44	2652.80	2910.90
	111"(2819mm)	VZGK-16B1-H 4	2292.73	2685.71	2947.55	2319.44	2712.42	2974.26
	114"(2896mm)	VZGK-16B4-H 4	2345.92	2744.52	3010.10	2373.44	2772.04	3037.62
	117"(2972mm)	VZGK-16B7-H 4	2399.11	2803.33	3072.65	2427.44	2831.66	3100.98
	120"(3048mm)	VZGK-16C0-H 4	2452.30	2862.14	3135.20	2481.44	2891.28	3164.34

Panel Accessories

Nominal Height	Nominal Width	Number	① ②	Trim A			Trim B		
				Clear Glass	Satin Etch	Frosted Acrylic	Clear Glass	Satin Etch	Frosted Acrylic
0.25"(6mm) Thick - Aluminum Trim									
8"(203mm)	18"(457mm)	VZGK-0818-A	4	\$ 619.72	\$ 821.62	\$ 956.30	\$ 621.32	\$ 823.22	\$ 957.90
	24"(610mm)	VZGK-0824-A	4	740.00	947.52	1085.94	743.24	950.76	1089.18
	30"(762mm)	VZGK-0830-A	4	860.28	1073.42	1215.58	865.16	1078.30	1220.46
	36"(914mm)	VZGK-0836-A	4	980.56	1199.32	1345.22	987.08	1205.84	1351.74
	39"(991mm)	VZGK-0839-A	4	1040.70	1262.27	1410.04	1048.04	1269.61	1417.38
	42"(1067mm)	VZGK-0842-A	4	1100.84	1325.22	1474.86	1109.00	1333.38	1483.02
	45"(1143mm)	VZGK-0845-A	4	1160.98	1388.17	1539.68	1169.96	1397.15	1548.66
	48"(1219mm)	VZGK-0848-A	4	1221.12	1451.12	1604.50	1230.92	1460.92	1614.30
	51"(1295mm)	VZGK-0851-A	4	1281.26	1514.07	1669.32	1291.88	1524.69	1679.94
	54"(1372mm)	VZGK-0854-A	4	1341.40	1577.02	1734.14	1352.84	1588.46	1745.58
	57"(1448mm)	VZGK-0857-A	4	1401.54	1639.97	1798.96	1413.80	1652.23	1811.22
	60"(1524mm)	VZGK-0860-A	4	1461.68	1702.92	1863.78	1474.76	1716.00	1876.86
	63"(1600mm)	VZGK-0863-A	4	1521.82	1765.87	1928.60	1535.72	1779.77	1942.50
	66"(1676mm)	VZGK-0866-A	4	1581.96	1828.82	1993.42	1596.68	1843.54	2008.14
	69"(1753mm)	VZGK-0869-A	4	1642.10	1891.77	2058.24	1657.64	1907.31	2073.78
	72"(1829mm)	VZGK-0872-A	4	1702.24	1954.72	2123.06	1718.60	1971.08	2139.42
	75"(1905mm)	VZGK-0875-A	4	1762.38	2017.67	2187.88	1779.56	2034.85	2205.06
	78"(1981mm)	VZGK-0878-A	4	1822.52	2080.62	2252.70	1840.52	2098.62	2270.70
	81"(2057mm)	VZGK-0881-A	4	1882.66	2143.57	2317.52	1901.48	2162.39	2336.34
	84"(2134mm)	VZGK-0884-A	4	1942.80	2206.52	2382.34	1962.44	2226.16	2401.98
	87"(2210mm)	VZGK-0887-A	4	2002.94	2269.47	2447.16	2023.40	2289.93	2467.62
	90"(2286mm)	VZGK-0890-A	4	2063.08	2332.42	2511.98	2084.36	2353.70	2533.26
	93"(2362mm)	VZGK-0893-A	4	2123.22	2395.37	2576.80	2145.32	2417.47	2598.90
	96"(2438mm)	VZGK-0896-A	4	2183.36	2458.32	2641.62	2206.28	2481.24	2664.54
	99"(2515mm)	VZGK-0899-A	4	2243.50	2521.27	2706.44	2267.24	2545.01	2730.18
	102"(2591mm)	VZGK-08A2-A	4	2303.64	2584.22	2771.26	2328.20	2608.78	2795.82
105"(2667mm)	VZGK-08A5-A	4	2363.78	2647.17	2836.08	2389.16	2672.55	2861.46	
108"(2743mm)	VZGK-08A8-A	4	2423.92	2710.12	2900.90	2450.12	2736.32	2927.10	
111"(2819mm)	VZGK-08B1-A	4	2484.06	2773.07	2965.72	2511.08	2800.09	2992.74	
114"(2896mm)	VZGK-08B4-A	4	2544.20	2836.02	3030.54	2572.04	2863.86	3058.38	
117"(2972mm)	VZGK-08B7-A	4	2604.34	2898.97	3095.36	2633.00	2927.63	3124.02	
120"(3048mm)	VZGK-08C0-A	4	2664.48	2961.92	3160.18	2693.96	2991.40	3189.66	
12"(305mm)	18"(457mm)	VZGK-1218-A	4	\$ 646.78	\$ 857.11	\$ 997.40	\$ 648.38	\$ 858.71	\$ 999.00
	24"(610mm)	VZGK-1224-A	4	776.08	994.84	1140.74	779.32	998.08	1143.98
	30"(762mm)	VZGK-1230-A	4	905.38	1132.57	1284.08	910.26	1137.45	1288.96
	36"(914mm)	VZGK-1236-A	4	1034.68	1270.30	1427.42	1041.20	1276.82	1433.94
	39"(991mm)	VZGK-1239-A	4	1103.84	1345.08	1505.94	1111.18	1352.42	1513.28
	42"(1067mm)	VZGK-1242-A	4	1163.98	1408.03	1570.76	1172.14	1416.19	1578.92
	45"(1143mm)	VZGK-1245-A	4	1233.14	1482.81	1649.28	1242.12	1491.79	1658.26
	48"(1219mm)	VZGK-1248-A	4	1293.28	1545.76	1714.10	1303.08	1555.56	1723.90
	51"(1295mm)	VZGK-1251-A	4	1362.44	1620.54	1792.62	1373.06	1631.16	1803.24
	54"(1372mm)	VZGK-1254-A	4	1422.58	1683.49	1857.44	1434.02	1694.93	1868.88
	57"(1448mm)	VZGK-1257-A	4	1491.74	1758.27	1935.96	1504.00	1770.53	1948.22
	60"(1524mm)	VZGK-1260-A	4	1551.88	1821.22	2000.78	1564.96	1834.30	2013.86
	63"(1600mm)	VZGK-1263-A	4	1621.04	1896.00	2079.30	1634.94	1909.90	2093.20
	66"(1676mm)	VZGK-1266-A	4	1681.18	1958.95	2144.12	1695.90	1973.67	2158.84
	69"(1753mm)	VZGK-1269-A	4	1750.34	2033.73	2222.64	1765.88	2049.27	2238.18
	72"(1829mm)	VZGK-1272-A	4	1810.48	2096.68	2287.46	1826.84	2113.04	2303.82
	75"(1905mm)	VZGK-1275-A	4	1879.64	2171.46	2365.98	1896.82	2188.64	2383.16
	78"(1981mm)	VZGK-1278-A	4	1939.78	2234.41	2430.80	1957.78	2252.41	2448.80
	81"(2057mm)	VZGK-1281-A	4	2008.94	2309.19	2509.32	2027.76	2328.01	2528.14
	84"(2134mm)	VZGK-1284-A	4	2069.08	2372.14	2574.14	2088.72	2391.78	2593.78
	87"(2210mm)	VZGK-1287-A	4	2138.24	2446.92	2652.66	2158.70	2467.38	2673.12
	90"(2286mm)	VZGK-1290-A	4	2198.38	2509.87	2717.48	2219.66	2531.15	2738.76
	93"(2362mm)	VZGK-1293-A	4	2267.54	2584.65	2796.00	2289.64	2606.75	2818.10
	96"(2438mm)	VZGK-1296-A	4	2327.68	2647.60	2860.82	2350.60	2670.52	2883.74
	99"(2515mm)	VZGK-1299-A	4	2396.84	2722.38	2939.34	2420.58	2746.12	2963.08
	102"(2591mm)	VZGK-12A2-A	4	2456.98	2785.33	3004.16	2481.54	2809.89	3028.72
105"(2667mm)	VZGK-12A5-A	4	2526.14	2860.11	3082.68	2551.52	2885.49	3108.06	
108"(2743mm)	VZGK-12A8-A	4	2586.28	2923.06	3147.50	2612.48	2949.26	3173.70	
111"(2819mm)	VZGK-12B1-A	4	2655.44	2997.84	3226.02	2682.46	3024.86	3253.04	
114"(2896mm)	VZGK-12B4-A	4	2715.58	3060.79	3290.84	2743.42	3088.63	3318.68	
117"(2972mm)	VZGK-12B7-A	4	2784.74	3135.57	3369.36	2813.40	3164.23	3398.02	
120"(3048mm)	VZGK-12C0-A	4	2844.88	3198.52	3434.18	2874.36	3228.00	3463.66	

Panel Accessories

Nominal Height	Nominal Width	Number ① ②	Trim A			Trim B		
			Clear Glass	Satin Etch	Frosted Acrylic	Clear Glass	Satin Etch	Frosted Acrylic
16"(406mm)	18"(457mm)	VZGK-1618-A 4	\$ 673.84	\$ 892.60	\$ 1038.50	\$ 675.44	\$ 894.20	\$ 1040.10
	24"(610mm)	VZGK-1624-A 4	812.16	1042.16	1195.54	815.40	1045.40	1198.78
	30"(762mm)	VZGK-1630-A 4	950.48	1191.72	1352.58	955.36	1196.60	1357.46
	36"(914mm)	VZGK-1636-A 4	1088.80	1341.28	1509.62	1095.32	1347.80	1516.14
	39"(991mm)	VZGK-1639-A 4	1157.96	1416.06	1588.14	1165.30	1423.40	1595.48
	42"(1067mm)	VZGK-1642-A 4	1227.12	1490.84	1666.66	1235.28	1499.00	1674.82
	45"(1143mm)	VZGK-1645-A 4	1296.28	1565.62	1745.18	1305.26	1574.60	1754.16
	48"(1219mm)	VZGK-1648-A 4	1365.44	1640.40	1823.70	1375.24	1650.20	1833.50
	51"(1295mm)	VZGK-1651-A 4	1434.60	1715.18	1902.22	1445.22	1725.80	1912.84
	54"(1372mm)	VZGK-1654-A 4	1503.76	1789.96	1980.74	1515.20	1801.40	1992.18
	57"(1448mm)	VZGK-1657-A 4	1572.92	1864.74	2059.26	1585.18	1877.00	2071.52
	60"(1524mm)	VZGK-1660-A 4	1642.08	1939.52	2137.78	1655.16	1952.60	2150.86
	63"(1600mm)	VZGK-1663-A 4	1711.24	2014.30	2216.30	1725.14	2028.20	2230.20
	66"(1676mm)	VZGK-1666-A 4	1780.40	2089.08	2294.82	1795.12	2103.80	2309.54
	69"(1753mm)	VZGK-1669-A 4	1849.56	2163.86	2373.34	1865.10	2179.40	2388.88
	72"(1829mm)	VZGK-1672-A 4	1918.72	2238.64	2451.86	1935.08	2255.00	2468.22
	75"(1905mm)	VZGK-1675-A 4	1987.88	2313.42	2530.38	2005.06	2330.60	2547.56
	78"(1981mm)	VZGK-1678-A 4	2057.04	2388.20	2608.90	2075.04	2406.20	2626.90
	81"(2057mm)	VZGK-1681-A 4	2126.20	2462.98	2687.42	2145.02	2481.80	2706.24
	84"(2134mm)	VZGK-1684-A 4	2195.36	2537.76	2765.94	2215.00	2557.40	2785.58
	87"(2210mm)	VZGK-1687-A 4	2264.52	2612.54	2844.46	2284.98	2633.00	2864.92
	90"(2286mm)	VZGK-1690-A 4	2333.68	2687.32	2922.98	2354.96	2708.60	2944.26
	93"(2362mm)	VZGK-1693-A 4	2402.84	2762.10	3001.50	2424.94	2784.20	3023.60
	96"(2438mm)	VZGK-1696-A 4	2472.00	2836.88	3080.02	2494.92	2859.80	3102.94
	99"(2515mm)	VZGK-1699-A 4	2541.16	2911.66	3158.54	2564.90	2935.40	3182.28
	102"(2591mm)	VZGK-16A2-A 4	2610.32	2986.44	3237.06	2634.88	3011.00	3261.62
	105"(2667mm)	VZGK-16A5-A 4	2679.48	3061.22	3315.58	2704.86	3086.60	3340.96
	108"(2743mm)	VZGK-16A8-A 4	2748.64	3136.00	3394.10	2774.84	3162.20	3420.30
	111"(2819mm)	VZGK-16B1-A 4	2817.80	3210.78	3472.62	2844.82	3237.80	3499.64
	114"(2896mm)	VZGK-16B4-A 4	2886.96	3285.56	3551.14	2914.80	3313.40	3578.98
	117"(2972mm)	VZGK-16B7-A 4	2956.12	3360.34	3629.66	2984.78	3389.00	3658.32
	120"(3048mm)	VZGK-16C0-A 4	3025.28	3435.12	3708.18	3054.76	3464.60	3737.66
0.5"(13mm) Thick - Aluminum Trim								
8"(203mm)	18"(457mm)	VZGK-0818-A 2	\$ 839.53	\$ 979.18	N/A	\$ 841.13	\$ 980.78	N/A
	24"(610mm)	VZGK-0824-A 2	971.85	1120.88	N/A	975.09	1124.12	N/A
	30"(762mm)	VZGK-0830-A 2	1104.17	1262.58	N/A	1109.05	1267.46	N/A
	36"(914mm)	VZGK-0836-A 2	1236.49	1404.28	N/A	1243.01	1410.80	N/A
	39"(991mm)	VZGK-0839-A 2	1302.65	1475.13	N/A	1309.99	1482.47	N/A
	42"(1067mm)	VZGK-0842-A 2	1368.81	1545.98	N/A	1376.97	1554.14	N/A
	45"(1143mm)	VZGK-0845-A 2	1434.97	1616.83	N/A	1443.95	1625.81	N/A
	48"(1219mm)	VZGK-0848-A 2	1501.13	1687.68	N/A	1510.93	1697.48	N/A
	51"(1295mm)	VZGK-0851-A 2	1567.29	1758.53	N/A	1577.91	1769.15	N/A
	54"(1372mm)	VZGK-0854-A 2	1633.45	1829.38	N/A	1644.89	1840.82	N/A
	57"(1448mm)	VZGK-0857-A 2	1699.61	1900.23	N/A	1711.87	1912.49	N/A
	60"(1524mm)	VZGK-0860-A 2	1765.77	1971.08	N/A	1778.85	1984.16	N/A
	63"(1600mm)	VZGK-0863-A 2	1831.93	2041.93	N/A	1845.83	2055.83	N/A
	66"(1676mm)	VZGK-0866-A 2	1898.09	2112.78	N/A	1912.81	2127.50	N/A
	69"(1753mm)	VZGK-0869-A 2	1964.25	2183.63	N/A	1979.79	2199.17	N/A
	72"(1829mm)	VZGK-0872-A 2	2030.41	2254.48	N/A	2046.77	2270.84	N/A
	75"(1905mm)	VZGK-0875-A 2	2096.57	2325.33	N/A	2113.75	2342.51	N/A
	78"(1981mm)	VZGK-0878-A 2	2162.73	2396.18	N/A	2180.73	2414.18	N/A
	81"(2057mm)	VZGK-0881-A 2	2228.89	2467.03	N/A	2247.71	2485.85	N/A
	84"(2134mm)	VZGK-0884-A 2	2295.05	2537.88	N/A	2314.69	2557.52	N/A
	87"(2210mm)	VZGK-0887-A 2	2361.21	2608.73	N/A	2381.67	2629.19	N/A
	90"(2286mm)	VZGK-0890-A 2	2427.37	2679.58	N/A	2448.65	2700.86	N/A
	93"(2362mm)	VZGK-0893-A 2	2493.53	2750.43	N/A	2515.63	2772.53	N/A
	96"(2438mm)	VZGK-0896-A 2	2559.69	2821.28	N/A	2582.61	2844.20	N/A
99"(2515mm)	VZGK-0899-A 2	2625.85	2892.13	N/A	2649.59	2915.87	N/A	
102"(2591mm)	VZGK-08A2-A 2	2692.01	2962.98	N/A	2716.57	2987.54	N/A	
105"(2667mm)	VZGK-08A5-A 2	2758.17	3033.83	N/A	2783.55	3059.21	N/A	
108"(2743mm)	VZGK-08A8-A 2	2824.33	3104.68	N/A	2850.53	3130.88	N/A	

Panel Accessories

Nominal Height	Nominal Width	Number ① ②	Trim A			Trim B		
			Clear Glass	Satin Etch	Frosted Acrylic	Clear Glass	Satin Etch	Frosted Acrylic
12"(305mm)	18"(457mm)	VZGK-1218-A 2	\$ 884.65	\$ 1038.37	N/A	\$ 886.25	\$ 1039.97	N/A
	24"(610mm)	VZGK-1224-A 2	1032.01	1199.80	N/A	1035.25	1203.04	N/A
	30"(762mm)	VZGK-1230-A 2	1179.37	1361.23	N/A	1184.25	1366.11	N/A
	36"(914mm)	VZGK-1236-A 2	1326.73	1522.66	N/A	1333.25	1529.18	N/A
	39"(991mm)	VZGK-1239-A 2	1407.93	1613.24	N/A	1415.27	1620.58	N/A
	42"(1067mm)	VZGK-1242-A 2	1474.09	1684.09	N/A	1482.25	1692.25	N/A
	45"(1143mm)	VZGK-1245-A 2	1555.29	1774.67	N/A	1564.27	1783.65	N/A
	48"(1219mm)	VZGK-1248-A 2	1621.45	1845.52	N/A	1631.25	1855.32	N/A
	51"(1295mm)	VZGK-1251-A 2	1702.65	1936.10	N/A	1713.27	1946.72	N/A
	54"(1372mm)	VZGK-1254-A 2	1768.81	2006.95	N/A	1780.25	2018.39	N/A
	57"(1448mm)	VZGK-1257-A 2	1850.01	2097.53	N/A	1862.27	2109.79	N/A
	60"(1524mm)	VZGK-1260-A 2	1916.17	2168.38	N/A	1929.25	2181.46	N/A
	63"(1600mm)	VZGK-1263-A 2	1997.37	2258.96	N/A	2011.27	2272.86	N/A
	66"(1676mm)	VZGK-1266-A 2	2063.53	2329.81	N/A	2078.25	2344.53	N/A
	69"(1753mm)	VZGK-1269-A 2	2144.73	2420.39	N/A	2160.27	2435.93	N/A
	72"(1829mm)	VZGK-1272-A 2	2210.89	2491.24	N/A	2227.25	2507.60	N/A
	75"(1905mm)	VZGK-1275-A 2	2292.09	2581.82	N/A	2309.27	2599.00	N/A
	78"(1981mm)	VZGK-1278-A 2	2358.25	2652.67	N/A	2376.25	2670.67	N/A
	81"(2057mm)	VZGK-1281-A 2	2439.45	2743.25	N/A	2458.27	2762.07	N/A
	84"(2134mm)	VZGK-1284-A 2	2505.61	2814.10	N/A	2525.25	2833.74	N/A
	87"(2210mm)	VZGK-1287-A 2	2586.81	2904.68	N/A	2607.27	2925.14	N/A
	90"(2286mm)	VZGK-1290-A 2	2652.97	2975.53	N/A	2674.25	2996.81	N/A
	93"(2362mm)	VZGK-1293-A 2	2734.17	3066.11	N/A	2756.27	3088.21	N/A
	96"(2438mm)	VZGK-1296-A 2	2800.33	3136.96	N/A	2823.25	3159.88	N/A
	99"(2515mm)	VZGK-1299-A 2	2881.53	3227.54	N/A	2905.27	3251.28	N/A
	102"(2591mm)	VZGK-12A2-A 2	2947.69	3298.39	N/A	2972.25	3322.95	N/A
	105"(2667mm)	VZGK-12A5-A 2	3028.89	3388.97	N/A	3054.27	3414.35	N/A
108"(2743mm)	VZGK-12A8-A 2	3095.05	3459.82	N/A	3121.25	3486.02	N/A	
16"(406mm)	18"(457mm)	VZGK-1618-A 2	\$ 929.77	\$ 1097.56	N/A	\$ 931.37	\$ 1099.16	N/A
	24"(610mm)	VZGK-1624-A 2	1092.17	1278.72	N/A	1095.41	1281.96	N/A
	30"(762mm)	VZGK-1630-A 2	1254.57	1459.88	N/A	1259.45	1464.76	N/A
	36"(914mm)	VZGK-1636-A 2	1416.97	1641.04	N/A	1423.49	1647.56	N/A
	39"(991mm)	VZGK-1639-A 2	1498.17	1731.62	N/A	1505.51	1738.96	N/A
	42"(1067mm)	VZGK-1642-A 2	1579.37	1822.20	N/A	1587.53	1830.36	N/A
	45"(1143mm)	VZGK-1645-A 2	1660.57	1912.78	N/A	1669.55	1921.76	N/A
	48"(1219mm)	VZGK-1648-A 2	1741.77	2003.36	N/A	1751.57	2013.16	N/A
	51"(1295mm)	VZGK-1651-A 2	1822.97	2093.94	N/A	1833.59	2104.56	N/A
	54"(1372mm)	VZGK-1654-A 2	1904.17	2184.52	N/A	1915.61	2195.96	N/A
	57"(1448mm)	VZGK-1657-A 2	1985.37	2275.10	N/A	1997.63	2287.36	N/A
	60"(1524mm)	VZGK-1660-A 2	2066.57	2365.68	N/A	2079.65	2378.76	N/A
	63"(1600mm)	VZGK-1663-A 2	2147.77	2456.26	N/A	2161.67	2470.16	N/A
	66"(1676mm)	VZGK-1666-A 2	2228.97	2546.84	N/A	2243.69	2561.56	N/A
	69"(1753mm)	VZGK-1669-A 2	2310.17	2637.42	N/A	2325.71	2652.96	N/A
	72"(1829mm)	VZGK-1672-A 2	2391.37	2728.00	N/A	2407.73	2744.36	N/A
	75"(1905mm)	VZGK-1675-A 2	2472.57	2818.58	N/A	2489.75	2835.76	N/A
	78"(1981mm)	VZGK-1678-A 2	2553.77	2909.16	N/A	2571.77	2927.16	N/A
	81"(2057mm)	VZGK-1681-A 2	2634.97	2999.74	N/A	2653.79	3018.56	N/A
	84"(2134mm)	VZGK-1684-A 2	2716.17	3090.32	N/A	2735.81	3109.96	N/A
	87"(2210mm)	VZGK-1687-A 2	2797.37	3180.90	N/A	2817.83	3201.36	N/A
	90"(2286mm)	VZGK-1690-A 2	2878.57	3271.48	N/A	2899.85	3292.76	N/A
	93"(2362mm)	VZGK-1693-A 2	2959.77	3362.06	N/A	2981.87	3384.16	N/A
	96"(2438mm)	VZGK-1696-A 2	3040.97	3452.64	N/A	3063.89	3475.56	N/A
	99"(2515mm)	VZGK-1699-A 2	3122.17	3543.22	N/A	3145.91	3566.96	N/A
	102"(2591mm)	VZGK-16A2-A 2	3203.37	3633.80	N/A	3227.93	3658.36	N/A
	105"(2667mm)	VZGK-16A5-A 2	3284.57	3724.38	N/A	3309.95	3749.76	N/A
108"(2743mm)	VZGK-16A8-A 2	3365.77	3814.96	N/A	3391.97	3841.16	N/A	

Panel Accessories

Frameless Glass Bottom Rail

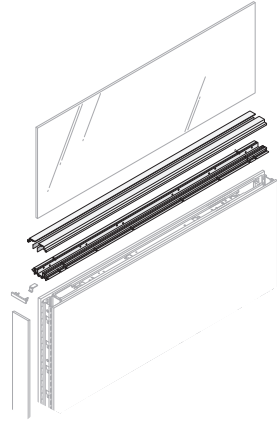

VZGR
Class BC

Features

- Includes one grooved bottom rail with or without notch (es) and mounting hardware for steel trim application.
- For custom insert application only; required field supplied 0.25"(6mm) or 0.5"(13mm) thick insert.**
 - 0.25"(6mm) thick insert for use with Steel or Aluminum trim options.
 - 0.5"(13mm) thick insert for use with Aluminum trim option only.
- When using glass, safety tempered glass is required. Laminated glass may NOT be used.
- Mounting Options:
 - (S) - Same height application, in-line.
 - (V) - Variable height application, one end.
 - (D) - Variable height application, both ends.
- Bottom Rail trim is bolted on frame in place of top trim.

Specification Tips

- Not for use with glass panel frames or glass stack frames.
- May be the same width as a single panel or span a maximum of two full panel frames or stack frames in an in-line condition or spanning 90°, 3- or 4-way panel intersection.
- Bottom Rail:
 - Used in place of top trim.**
 - Not for use above a glass panel or glass stack.
- Mounting Option (V) has notch on one end to accommodate one Variable Height Cover.
- Mounting Option (D) has notches on both ends to accommodate two Variable Height Covers.
- Bottom Rail End Cap and End-of-Run Clip are application specific; separately specify as needed.

To Order, Specify:

1) Product number, including:

1 Mounting Options

- S** Same height/in-line
- V** Variable height/one end (add **\$22.77** list)
- D** Variable height/both ends (add **\$45.51** list)

2 Insert Thickness

































(Aluminum trim only)

- 4** 0.25"(6mm)
- 2** 0.5"(13mm) (add **\$3.06** list)

2) Trim color.

Height	Depth	Width	Number ①	Trim A	B
Steel					
0.375"(10mm)	3"(76mm)	18"(457mm)	VZGR-0018-H 4	\$ 306.54	\$ 308.07
		24"(610mm)	VZGR-0024-H 4	347.50	350.55
		30"(762mm)	VZGR-0030-H 4	388.46	393.03
		36"(914mm)	VZGR-0036-H 4	429.42	435.51
		39"(991mm)	VZGR-0039-H 4	449.90	456.75
		42"(1067mm)	VZGR-0042-H 4	470.38	477.99
		45"(1143mm)	VZGR-0045-H 4	490.86	499.23
		48"(1219mm)	VZGR-0048-H 4	511.34	520.47
		51"(1295mm)	VZGR-0051-H 4	531.82	541.71
		54"(1372mm)	VZGR-0054-H 4	552.30	562.95
		57"(1448mm)	VZGR-0057-H 4	572.78	584.19
		60"(1524mm)	VZGR-0060-H 4	593.26	605.43
		63"(1600mm)	VZGR-0063-H 4	613.74	626.67
		66"(1676mm)	VZGR-0066-H 4	634.22	647.91
		69"(1753mm)	VZGR-0069-H 4	654.70	669.15
		72"(1829mm)	VZGR-0072-H 4	675.18	690.39
		75"(1905mm)	VZGR-0075-H 4	695.66	711.63
		78"(1981mm)	VZGR-0078-H 4	716.14	732.87
		81"(2057mm)	VZGR-0081-H 4	736.62	754.11
		84"(2134mm)	VZGR-0084-H 4	757.10	775.35
		87"(2210mm)	VZGR-0087-H 4	777.58	796.59
		90"(2286mm)	VZGR-0090-H 4	798.06	817.83
		93"(2362mm)	VZGR-0093-H 4	818.54	839.07
		96"(2438mm)	VZGR-0096-H 4	839.02	860.31
		99"(2515mm)	VZGR-0099-H 4	859.50	881.55
		102"(2591mm)	VZGR-00A2-H 4	879.98	902.79
		105"(2667mm)	VZGR-00A5-H 4	900.46	924.03
		108"(2743mm)	VZGR-00A8-H 4	920.94	945.27
		111"(2819mm)	VZGR-00B1-H 4	941.42	966.51
		114"(2896mm)	VZGR-00B4-H 4	961.90	987.75
		117"(2972mm)	VZGR-00B7-H 4	982.38	1008.99
		120"(3048mm)	VZGR-00C0-H 4	1002.86	1030.23

Panel Accessories

Height	Depth	Width	Number 	Trim A	B
Aluminum					
0.375"(10mm)	3"(76mm)	18"(457mm)	VZGR-0018-A 	\$ 311.87	\$ 313.36
		24"(610mm)	VZGR-0024-A 	360.41	363.44
		30"(762mm)	VZGR-0030-A 	408.95	413.52
		36"(914mm)	VZGR-0036-A 	457.49	463.60
		39"(991mm)	VZGR-0039-A 	481.76	488.64
		42"(1067mm)	VZGR-0042-A 	506.03	513.68
		45"(1143mm)	VZGR-0045-A 	530.30	538.72
		48"(1219mm)	VZGR-0048-A 	554.57	563.76
		51"(1295mm)	VZGR-0051-A 	578.84	588.80
		54"(1372mm)	VZGR-0054-A 	603.11	613.84
		57"(1448mm)	VZGR-0057-A 	627.38	638.88
		60"(1524mm)	VZGR-0060-A 	651.65	663.92
		63"(1600mm)	VZGR-0063-A 	675.92	688.96
		66"(1676mm)	VZGR-0066-A 	700.19	714.00
		69"(1753mm)	VZGR-0069-A 	724.46	739.04
		72"(1829mm)	VZGR-0072-A 	748.73	764.08
		75"(1905mm)	VZGR-0075-A 	773.00	789.12
		78"(1981mm)	VZGR-0078-A 	797.27	814.16
		81"(2057mm)	VZGR-0081-A 	821.54	839.20
		84"(2134mm)	VZGR-0084-A 	845.81	864.24
		87"(2210mm)	VZGR-0087-A 	870.08	889.28
		90"(2286mm)	VZGR-0090-A 	894.35	914.32
		93"(2362mm)	VZGR-0093-A 	918.62	939.36
		96"(2438mm)	VZGR-0096-A 	942.89	964.40
		99"(2515mm)	VZGR-0099-A 	967.16	989.44
		102"(2591mm)	VZGR-00A2-A 	991.43	1014.48
		105"(2667mm)	VZGR-00A5-A 	1015.70	1039.52
		108"(2743mm)	VZGR-00A8-A 	1039.97	1064.56
		111"(2819mm)	VZGR-00B1-A 	1064.24	1089.60
		114"(2896mm)	VZGR-00B4-A 	1088.51	1114.64
		117"(2972mm)	VZGR-00B7-A 	1112.78	1139.68
		120"(3048mm)	VZGR-00C0-A 	1137.05	1164.72

Panel Accessories

Bottom Rail End Cap

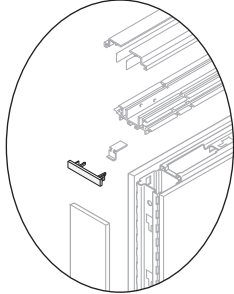

VZGE
Class BC

Feature

- Includes one steel or aluminum non-handed Bottom Rail End Cap.

Specification Tips

- Bottom Rail End Cap is used to cover open end of Bottom Rail in an exposed application.
- Aluminum:
 - For use in 2-, 3-, and 4-way, End-of-Run, and stand-alone in-line frameless glass application; refer to Application Guidelines.
- Steel:
 - Specify -HE option for End-of-Run Frameless Glass application; refer to Application Guidelines.
 - Specify -HI option for 2-, 3-, and 4-way, and stand-alone in-line frameless glass application; refer to Application Guidelines.

To Order, Specify:

- 1) Product number.
- 2) Trim color.

Description	Height	Depth	Number	Trim A	B
Steel, for End-of-Run	0.375"(10mm)	2.375"(60mm)	VZGE-0000-HE	\$55.69	\$66.38
Steel, for In-line/Corner			VZGE-0000-HI	55.69	66.38
Aluminum			VZGE-0000-A	55.69	66.38

Frameless Glass — End-of-Run Clip for use with Aluminum Bottom Rail

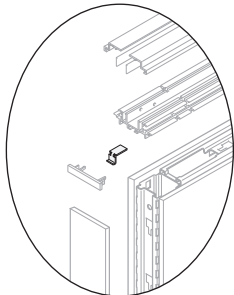

VZGC-000
Class BC

Features

- Includes one End-of-Run Clip.
- For use with End-of-Run trim and replaces standard End-of-Run clip in Frameless Glass application.

Specification Tip

- For use with Aluminum Bottom Rail only.

To Order, Specify:

- 1) Product number.
(No color specification required.)

Number	Price
VZGC-0000	\$30.32

Glass Top Trim Clip Kit

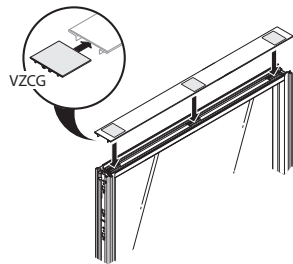

VZCG-0000
Class BC

Feature

- Includes three attachment clips for connecting steel top trim to glass panels or glass stack frames.

Specification Tips

- Steel top trim only:
 - Must be used when spanning over a stack or panel frame and a glass stack or glass panel frame, specify the -HS trim option and order kit(s) separately for steel top trim that is spanning glass.

Clip Requirements

Top Trim Length	Clips Required
18" - 30"	2
36" - 60"	3
51", 66", 72"	4
78" - 90"	5
63", 75", 96" - 120"	6

To Order, Specify:

- 1) Product number.
(No finish specification required.)

Number	Price
VZCG-0000	\$32.09

Panel Accessories

Glass Topper

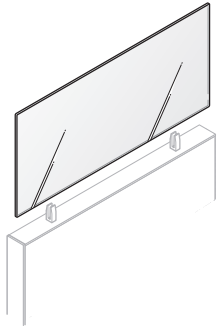

VZSG
Class BC

Features

- Includes one 0.25"(6mm) thick insert with beveled edges and dubbed corners.
- Mounting Options:
(S) - Same height application, in-line.
(V) - Variable height application, one end.
(D) - Variable height application, both ends.

Specification Tips

- **Only for use with Glass Topper Bottom Rail Kit for aluminum or steel trim profiles; separately specified.**
- Glass Topper and separately specified Glass Topper Bottom Rail Kit must be the same width as panel frame.
- May not span multiple panel frames or panel intersections.

To Order, Specify:

1) Product number, including:

1 Mounting Options

- S** Same height/in-line
- V** Variable height/one end
- D** Variable height/both ends

2) Insert color.

- 1C = Clear glass
- E21 = Satin Etch

Note: Custom glass insert may be field supplied:

- Glass thickness should be equal to 0.236"(6mm).
- Safety glass is required. Tempered glass is recommended.

Nominal Height	Nominal Width	Number 1	Clear Glass (1C)	Satin Etch (E21)
8"(203mm)	18"(457mm)	VZSG-0818-1 4	\$ 376.84	\$395.95
	24"(610mm)	VZSG-0824-1 4	410.25	454.17
	30"(762mm)	VZSG-0830-1 4	443.66	512.39
	36"(914mm)	VZSG-0836-1 4	477.07	570.61
	42"(1067mm)	VZSG-0842-1 4	510.48	628.83
	48"(1219mm)	VZSG-0848-1 4	543.89	687.05
	54"(1372mm)	VZSG-0854-1 4	577.30	745.27
	60"(1524mm)	VZSG-0860-1 4	610.71	803.49
	72"(1829mm)	VZSG-0872-1 4	878.16	1120.56
12"(305mm)	18"(457mm)	VZSG-1218-1 4	\$ 416.15	\$ 473.47
	24"(610mm)	VZSG-1224-1 4	449.56	531.69
	30"(762mm)	VZSG-1230-1 4	482.97	589.91
	36"(914mm)	VZSG-1236-1 4	516.38	648.13
	42"(1067mm)	VZSG-1242-1 4	549.79	706.35
	48"(1219mm)	VZSG-1248-1 4	604.82	786.19
	54"(1372mm)	VZSG-1254-1 4	638.23	844.41
	60"(1524mm)	VZSG-1260-1 4	671.64	902.63
	72"(1829mm)	VZSG-1272-1 4	939.09	1219.70
16"(406mm)	18"(457mm)	VZSG-1618-1 4	\$ 455.46	\$550.99
	24"(610mm)	VZSG-1624-1 4	488.87	609.21
	30"(762mm)	VZSG-1630-1 4	522.28	667.43
	36"(914mm)	VZSG-1636-1 4	555.69	725.65
	42"(1067mm)	VZSG-1642-1 4	589.10	783.87
	48"(1219mm)	VZSG-1648-1 4	701.12	920.70
	54"(1372mm)	VZSG-1654-1 4	734.53	978.92
	60"(1524mm)	VZSG-1660-1 4	767.94	1037.14
	72"(1829mm)	VZSG-1672-1 4	1035.39	1354.21

Panel Accessories

Glass Topper — Bottom Rail Kit

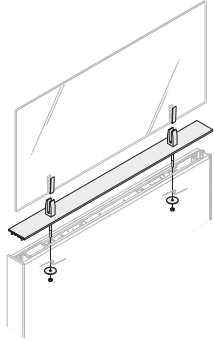

VZST
Class BC

Features

- Includes one **aluminum or steel top trim** with holes and mounting hardware.
- **Designed for use with 0.25"(6mm) thick insert; separately specified glass topper or field supplied glass.**
- Top trim with holes is bolted on standard frame.

Specification Tips

- Not for use with glass panel frames or glass stack frame.
- Top trim with holes must be same width as panel frame.
- Used in place of Full Profile Aluminum or Thin Profile Steel Top Trim.
- Glass Topper Bottom Rail Kit and separately specified Glass Topper must be the same width as panel frame.
- May not span multiple panel frames or panel intersections.

To Order, Specify:

1) Product number, including:

1 Top Trim Attachment

- H** Steel
- A** Aluminum

2) Trim color.

Height	Depth	Width	Number ①	Steel (H) Trim		Aluminum (A) Trim	
				A	B	A	B
0.375"(10mm)	3"(76mm)	18"(457mm)	VZST-0018-■ 4	\$ 196.11	\$ 206.70	\$ 217.78	\$ 228.37
		24"(610mm)	VZST-0024-■ 4	203.24	217.36	233.83	247.95
		30"(762mm)	VZST-0030-■ 4	210.37	228.02	249.88	267.53
		36"(914mm)	VZST-0036-■ 4	217.50	238.68	265.93	287.11
		42"(1067mm)	VZST-0042-■ 4	224.63	249.34	281.98	306.69
		48"(1219mm)	VZST-0048-■ 4	231.76	260.00	298.03	326.27
		54"(1372mm)	VZST-0054-■ 4	238.89	270.66	314.08	345.85
		60"(1524mm)	VZST-0060-■ 4	246.02	281.32	330.13	365.43
		72"(1829mm)	VZST-0072-■ 4	397.15	439.51	499.10	541.46

Alignment Clip Kit

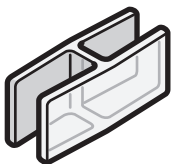

VZSG
Class BC

Feature

- Includes 10 clear polycarbonate clips.

Specification Tips

- For use when aligning two 0.25"(6mm) Compose Glass Toppers or Frameless Glass.
- Recommended when Glass Toppers are specified in line with each other.

To Order, Specify:

1) Product number.
(No finish specification required.)

Number	Price
VZSG-0000	\$499.82

Panel Accessories

Sliding Door

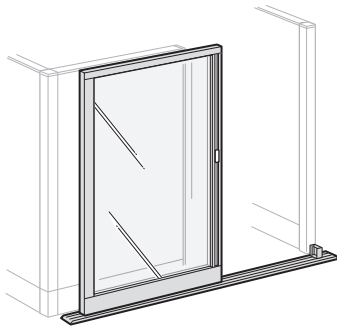

VUZF (left-hand shown)
Class BC

Features

- Includes sliding door with track without lock.
- Available with clear glass or frosted acrylic door insert.
- Full height integrated vertical finger-pull door handle.
- Sliding Door adjustable wheels allow 1.25"(32mm) height adjustment.
- Optional door lock is available; locks with key outside and lever inside. Not field retrofitable.
- Threshold is 0.45"(11mm).
- Lock plugs are black.
- For lock options, refer to Lock Program section of the Accessories Price List.
- Locking mechanism locks the door into the track.
- Right-handed door mounts on right side and slides open to right.
- Left-handed door mounts on left side and slides open to left.

Specification Tips

- Handedness cannot be changed in the field.
- Sliding Door mounts outside of the workspace.
- Threshold track is included and must be used with the Slider Door.
- Sliding Door Filler Post is required in certain applications and ordered separately. Refer to Specification Guide.
- **Glass Stack purchased prior to August 2008 requires field replacement of M Rail Kit; available through eParts.**
- **Not available for use with Open Base.**
- When installing in a 2-way application, must order extended glide bracket part# 2206-4905.

To Order, Specify:

1) Product number, including:

1 Insert Option:

- G Clear Glass (1C)
- X Frosted Acrylic (1E)

2 Handedness Option:

- R Right
- L Left

3 Locking Option:

- N Non-Locking
- L Locking (add **\$637.93** list)

2) Trim color.

Nominal Height	Nominal Depth	Number 1 2 3	Trim A	Frosted	Trim B	Frosted
			Clear Glass (1C)	Acrylic (1E)	Clear Glass (1C)	Acrylic (1E)
66"(1676mm)	36"(914mm)	VUZF-6636- ■ ■ ■ Z	\$4628.62	\$ 5159.17	\$4659.62	\$ 5190.17
	42"(1067mm)	VUZF-6642- ■ ■ ■ Z	4864.74	5627.93	4897.46	5660.65
74"(1880mm)	36"(914mm)	VUZF-7436- ■ ■ ■ Z	\$4806.46	\$5420.37	\$4864.98	\$5478.89
	42"(1067mm)	VUZF-7442- ■ ■ ■ Z	5042.58	5889.13	5102.82	5949.37
82"(2083mm)	36"(914mm)	VUZF-8236- ■ ■ ■ Z	\$4984.30	\$ 5681.57	\$5070.34	\$ 5767.61
	42"(1067mm)	VUZF-8242- ■ ■ ■ Z	5220.42	6150.33	5308.18	6238.09

Filler Post — Sliding Door

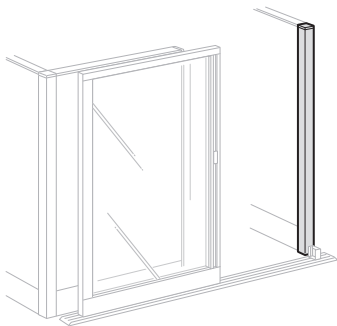

VZZP
Class CA

Feature

- Includes filler post and attachment hardware.

Specification Tips

- Filler post is required for certain Sliding Door applications. Refer to Specification Guide.
- Specify filler post to match panel height in all applications.

To Order, Specify:

1) Product number, including:

1 Trim Option:

- H Steel
- P Aluminum or Wood

2) Trim color.

Nominal Height	Number 1	Steel (H) Trim		Aluminum/Wood (P) Trim	
		A	B	A	B
66"(1676mm)	VZZP-6600- ■	\$628.73	\$663.88	\$ 818.32	\$ 853.47
74"(1880mm)	VZZP-7400- ■	691.53	726.68	881.12	916.27
82"(2083mm)	VZZP-8200- ■	754.33	789.48	943.92	979.07
90"(2286mm)	VZZP-9000- ■	817.13	852.28	1006.72	1041.87

Panel Accessories

Top Trim

Steel, Aluminum, Wood

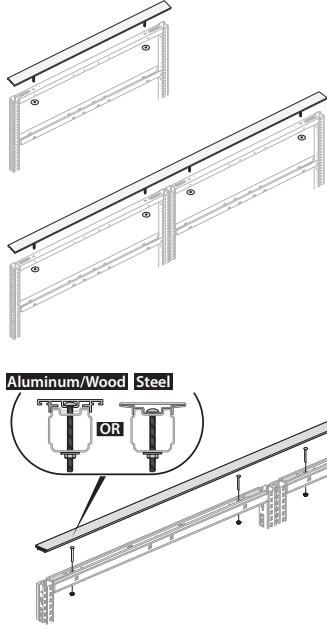

VZCC
Class BC

Features

- Includes thin profile steel, full profile aluminum, or full profile wood top trim.
- Aluminum and wood top trim 0.25"(6mm) thick; steel top trim 0.125"(3mm) thick.
- 3"(76mm)D.
- Trim is bolted on standard frame, snap-on with glass panels.

Specification Tips

- Top trim width may:
 - be the same as a single frame
 - span two in-line frames
 - span a 3- or 4-way intersection and two adjacent frames; one on each side of the intersection.
- Not for use with 2-way intersections.
- Required for all panel configurations (may be same width as panel.)
- Steel top trim; specify when necessary
 - Standard frame (HS)
 - Glass panel or glass stack (HG)
 - Glass top trim clip kit (if applicable)
- Mixing top trim types (ie. aluminum, steel, wood or work rail) is not recommended.
- Wood grain direction is same direction as width.

To Order, Specify:

- 1) Product number, including

Option:

- HS** Steel: Standard Frame
- HG** Steel: Glass Panel or Glass Stack
- A** Aluminum
- W** Wood

- 2) Trim color or wood finish color.

Width	Number ①	Steel (HS) Trim		Steel (HG) Trim		Aluminum (A) Trim		Wood (W) Wood	
		A	B	A	B	A	B	A	B
18"(457mm)	VZCC-0018-	\$ 65.31	\$ 67.08	\$ 81.48	\$ 83.25	\$ 175.07	\$ 176.84	\$ 434.21	\$ 480.32
24"(610mm)	VZCC-0024-	72.39	75.94	89.96	93.51	185.69	189.24	490.71	543.92
30"(762mm)	VZCC-0030-	79.47	84.80	98.44	103.77	196.31	201.64	547.21	607.52
36"(914mm)	VZCC-0036-	86.55	93.66	106.92	114.03	206.93	214.04	603.71	671.12
39"(991mm)	VZCC-0039-	90.09	98.09	111.16	119.16	212.24	220.24	631.96	702.92
42"(1067mm)	VZCC-0042-	93.63	102.52	115.40	124.29	217.55	226.44	660.21	734.72
45"(1143mm)	VZCC-0045-	97.17	106.95	119.64	129.42	222.86	232.64	688.46	766.52
48"(1219mm)	VZCC-0048-	100.71	111.38	123.88	134.55	228.17	238.84	716.71	798.32
51"(1295mm)	VZCC-0051-	104.25	115.81	128.12	139.68	233.48	245.04	744.96	830.12
54"(1372mm)	VZCC-0054-	107.79	120.24	132.36	144.81	238.79	251.24	773.21	861.92
57"(1448mm)	VZCC-0057-	111.33	124.67	136.60	149.94	244.10	257.44	801.46	893.72
60"(1524mm)	VZCC-0060-	114.87	129.10	140.84	155.07	249.41	263.64	829.71	925.52
63"(1600mm)	VZCC-0063-	150.18	165.30	176.85	191.97	274.13	289.25	877.37	976.73
66"(1676mm)	VZCC-0066-	153.72	169.73	181.09	197.10	281.65	297.66	907.83	1010.74
69"(1753mm)	VZCC-0069-	157.26	174.16	185.33	202.23	289.17	306.07	938.29	1044.75
72"(1829mm)	VZCC-0072-	160.80	178.59	189.57	207.36	296.69	314.48	968.75	1078.76
75"(1905mm)	VZCC-0075-	164.34	183.02	193.81	212.49	304.21	322.89	999.21	1112.77
78"(1981mm)	VZCC-0078-	167.88	187.45	198.05	217.62	311.73	331.30	1029.67	1146.78
81"(2057mm)	VZCC-0081-	171.42	191.88	202.29	222.75	319.25	339.71	1060.13	1180.79
84"(2134mm)	VZCC-0084-	174.96	196.31	206.53	227.88	326.77	348.12	1090.59	1214.80
87"(2210mm)	VZCC-0087-	178.50	200.74	210.77	233.01	334.29	356.53	1121.05	1248.81
90"(2286mm)	VZCC-0090-	182.04	205.17	215.01	238.14	341.81	364.94	1151.51	1282.82
93"(2362mm)	VZCC-0093-	185.58	209.60	219.25	243.27	349.33	373.35	1181.97	1316.83
96"(2438mm)	VZCC-0096-	189.12	214.03	223.49	248.40	356.85	381.76	1212.43	1350.84
99"(2515mm)	VZCC-0099-	192.66	218.46	227.73	253.53	364.37	390.17	1242.89	1384.85
102"(2591mm)	VZCC-0102-	196.20	222.89	231.97	258.66	371.89	398.58	1273.35	1418.86
105"(2667mm)	VZCC-0105-	199.74	227.32	236.21	263.79	379.41	406.99	1303.81	1452.87
108"(2743mm)	VZCC-0108-	203.28	231.75	240.45	268.92	386.93	415.40	1334.27	1486.88
111"(2819mm)	VZCC-0111-	206.82	236.18	244.69	274.05	394.45	423.81	1364.73	1520.89
114"(2896mm)	VZCC-0114-	210.36	240.61	248.93	279.18	402.00	432.22	1395.19	1554.90
117"(2972mm)	VZCC-0117-	213.90	245.04	253.17	284.31	409.52	440.63	1425.65	1588.91
120"(3048mm)	VZCC-0120-	217.44	249.47	257.41	289.44	417.04	449.04	1456.11	1622.92

Panel Accessories

Top Trim

Work Rail

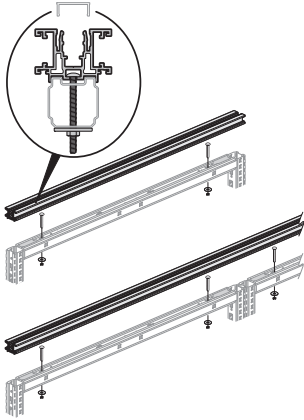

VZCC
Class BC

Features

- Includes one aluminum work rail and attachment hardware.
- Accepts Work Rail Top Trim Cover, Belong Plus Center Screen, Stanchion for use with Work Rail Top Trim, Intuity Center Screen, and Work Rail Off-Modular worksurface bracket.
- Work Rail Top Trim is 1.5" (38mm)H.
- Trim is bolted on Compose frame.

Specification Tips

- Not for use with Glass Panels or Glass Stack Kit.
- Top trim width may:
 - be the same as a single panel frame
 - span two in-line panel frames
 - span a 3- or 4-way intersection and two adjacent panel frames; one on each side of the intersection.
- May not span a 2-way intersection and adjacent panel frame.
- It is not recommended to use Aluminum Top Trim, Steel Top Trim and Work Rail Top Trim on adjacent panel frames in an In-Line condition or a 2-, 3-, or 4-way intersection.
- When specifying panel trim or corner connectors select the option "For use with Work Rail Top Trim"; not for use with Aluminum Top Trim option.

To Order, Specify:

- 1) Product number.
- 2) Trim color.

Height	Width	Number	Trim A	B
1.5" (38mm)	18" (457mm)	VZCC-0018-AG	\$ 551.43	\$ 553.20
	24" (610mm)	VZCC-0024-AG	570.85	574.40
	30" (762mm)	VZCC-0030-AG	590.27	595.60
	36" (914mm)	VZCC-0036-AG	609.69	616.80
	39" (991mm)	VZCC-0039-AG	619.40	627.40
	42" (1067mm)	VZCC-0042-AG	629.11	638.00
	45" (1143mm)	VZCC-0045-AG	638.82	648.60
	48" (1219mm)	VZCC-0048-AG	648.53	659.20
	51" (1295mm)	VZCC-0051-AG	658.24	669.80
	54" (1372mm)	VZCC-0054-AG	667.95	680.40
	57" (1448mm)	VZCC-0057-AG	677.66	691.00
	60" (1524mm)	VZCC-0060-AG	687.37	701.60
	63" (1600mm)	VZCC-0063-AG	1082.08	1097.20
	66" (1676mm)	VZCC-0066-AG	1091.79	1107.80
	69" (1753mm)	VZCC-0069-AG	1101.50	1118.40
	72" (1829mm)	VZCC-0072-AG	1111.21	1129.00
	75" (1905mm)	VZCC-0075-AG	1120.92	1139.60
	78" (1981mm)	VZCC-0078-AG	1130.63	1150.20
	81" (2057mm)	VZCC-0081-AG	1140.34	1160.80
	84" (2134mm)	VZCC-0084-AG	1150.05	1171.40
87" (2210mm)	VZCC-0087-AG	1159.76	1182.00	
90" (2286mm)	VZCC-0090-AG	1169.47	1192.60	
93" (2362mm)	VZCC-0093-AG	1179.18	1203.20	
96" (2438mm)	VZCC-0096-AG	1188.89	1213.80	
99" (2515mm)	VZCC-0099-AG	1198.60	1224.40	
102" (2591mm)	VZCC-0102-AG	1208.31	1235.00	
105" (2667mm)	VZCC-0105-AG	1218.02	1245.60	
108" (2743mm)	VZCC-0108-AG	1227.73	1256.20	
111" (2819mm)	VZCC-0111-AG	1237.44	1266.80	
114" (2896mm)	VZCC-0114-AG	1247.15	1277.40	
117" (2972mm)	VZCC-0117-AG	1256.86	1288.00	
120" (3048mm)	VZCC-0120-AG	1266.57	1298.60	

Panel Accessories

Top Trim

Off Modular Top Trim

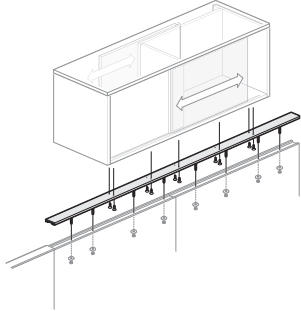

UZCC
Class BC

Features

- Includes Full Profile Aluminum Off Modular top trim and attachment hardware.
- Use to center mount a Countertop or Be_Hold or Be_Hold Be overhead storage unit to modular or off modular applications.

Specification Tips

- Designed to be used in Full Profile Aluminum top trim applications only.
- Recommended panel height is 42"(1067mm) to 50"(1270mm) when used with transaction worksurface.
- When mounting Overhead Storage Unit, recommended panel height is 42"(1067mm) to 50"(1270mm). There is no limit to mounting to 26"(660mm)H to 74"(1880mm)H.
- Field drilling required.

To Order, Specify:

- 1) Product number.
- 2) Trim color.

Number	Trim A	B
UZCC-0018-A	\$ 187.31	\$ 189.02
UZCC-0024-A	203.75	206.32
UZCC-0030-A	220.19	222.76
UZCC-0036-A	236.63	239.20
UZCC-0042-A	253.07	255.64
UZCC-0048-A	269.51	272.08
UZCC-0051-A	277.73	280.30
UZCC-0054-A	285.95	288.52
UZCC-0060-A	302.39	304.96
UZCC-0063-A	350.01	352.58
UZCC-0066-A	358.23	360.80
UZCC-0072-A	374.67	377.24
UZCC-0075-A	418.86	421.43
UZCC-0078-A	427.08	429.65
UZCC-0084-A	443.52	446.09
UZCC-0090-A	459.96	462.53
UZCC-0096-A	476.40	478.97
UZCC-0102-A	492.84	495.41
UZCC-0108-A	509.28	511.85
UZCC-0114-A	525.72	528.29
UZCC-0120-A	542.16	544.73

Panel Accessories

Top Trim

Work Rail Top Trim Cover

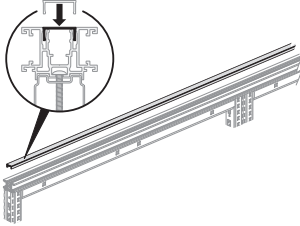

VZCR
Class BC

Features

- Includes one aluminum rail cover.
- Installs in top channel of Work Rail Top Trim only.
- Can be field cut to fill in top channel where screens or stanchions are not used.

Specification Tips

- Specify 60"(1524mm) for spans of 60"(1524mm) or less.
- Specify 72"(1829mm) for spans of 60"(1524mm)-72"(1829mm).
- Specify 120"(3048mm) for spans greater than 72"(1829mm).

To Order, Specify:

- 1) Product number.
- 2) Trim color.

Width	Number	Trim	
		A	B
60"(1524mm)	VZCR-0060-AG	\$466.61	\$468.39
72"(1829mm)	VZCR-0072-AG	559.91	563.49
120"(3048mm)	VZCR-0120-AG	933.11	943.89

Work Rail Top Trim Off-Modular Bracket

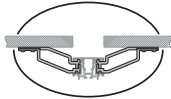
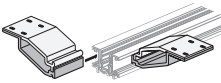

ZZBD
Class BC

Features

- Includes one bracket and attachment hardware.
- Installs in the side channel of Work Rail Top Trim.
- Provides worksurface support in modular or off-modular conditions.
- Bracket for use with Adaptable Worksurfaces.
- Locates underside of worksurface at 28"(711mm) when panel glides are fully recessed.
- Provides clear leg support when supporting 24"(610mm) and 30"(762mm)D worksurfaces.

Specification Tips

- Only for use with 26"(660mm)H full panel frame, Connections or Beam with separately specified work rail.
- Worksurface front corners support requirements:
 - One corner must be floor supported.
 - Second corner must be either floor supported or attached to an adjacent worksurface with a flush mount kit.
 - The distance between these floor supports may not exceed 10 feet.
- For use with Work Rail Top Trim only.

To Order, Specify:

- 1) Product number.
- 2) Trim color.

Bracket Requirements

Length of a particular worksurface Connections spine (inches)	Min # of Brackets Required (qty)
24-42	2
48-78	3
84-120	4

Number	Trim	
	A	B
ZZBD-0200-CNG	\$194.41	\$202.19

Panel Accessories

Full Panel

End-of-Run Trim — Steel/Aluminum/Wood



VZCE-3400-H
Class BC

Features

- Includes thin profile steel or full profile aluminum or wood trim cover, attachment hardware and alignment tab.
- Aluminum and wood trim are 0.25”(6mm) thick; steel trim is 0.125”(3mm) thick; 3”(76mm)D.

Specification Tips

- When adding stack to panel frame, order trim cover to match overall height of panel and stack.
- For variable height situations, refer to Specification Guide for Planning with Intersections.
- Mixing steel trim with wood or aluminum not recommended.
- Standard trim guidelines apply to Open Base.
- Specification Option (-F): The top of the End-of-Run steel panel trim attaches to a frameless glass bottom rail.

To Order, Specify:

- 1) Product number, including:

Option:

- H** Steel
- F** Steel/Frameless Glass - End-of-Run (add **\$19.60** list to **H** Steel option)
- A** Aluminum
- W** Wood

- 2) Trim color or wood finish color for vertical cover.

Height	Number ①	Steel (H) Trim		Aluminum (A) Trim		Wood (W) Wood	
		A	B	A	B	A	B
26”(660mm)	VZCE-2600-	\$ 67.35	\$ 84.55	\$205.96	\$ 223.16	\$ 582.33	\$ 629.25
34”(864mm)	VZCE-3400-	75.83	99.91	241.80	265.88	706.57	760.29
42”(1067mm)	VZCE-4200-	84.31	115.27	277.64	308.60	830.81	891.33
50”(1270mm)	VZCE-5000-	92.79	130.63	313.48	351.32	955.05	1022.37
58”(1473mm)	VZCE-5800-	101.27	145.99	349.32	394.04	1079.29	1153.41
66”(1676mm)	VZCE-6600-	109.75	161.35	385.16	436.76	1203.53	1284.45
74”(1880mm)	VZCE-7400-	125.75	184.23	421.00	479.48	1327.77	1415.49
82”(2083mm)	VZCE-8200-	141.75	207.11	456.84	522.20	1452.01	1546.53
90”(2286mm)	VZCE-9000-	157.75	229.99	492.68	564.92	1576.25	1677.57

End-of-Run Trim — Work Rail

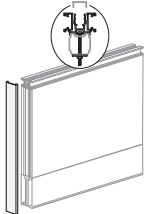

VZCE-AAANG
Class BC

Features

- Includes full profile aluminum trim, attachment hardware and alignment tab.
- Aluminum top trim is 0.25”(6mm) thick; 3”(76mm)D.

Specification Tips

- Order trim cover to match overall height of full frame and work rail.
- For variable height situations, refer to Specification Guide for Planning with intersections.
- Only work rail top trim may be used adjacent to cover.
- Work rail trim and connectors not available in thin profile steel or full profile wood trim

To Order, Specify:

- 1) Product number.
- 2) Trim color.

Height	Number	Trim A	B
28”(711mm)	VZCE-2800-ANNG	\$202.43	\$ 221.76
36”(914mm)	VZCE-3600-ANNG	238.83	265.20
44”(1118mm)	VZCE-4400-ANNG	275.23	308.64
52”(1321mm)	VZCE-5200-ANNG	311.63	352.08
60”(1524mm)	VZCE-6000-ANNG	348.03	395.52
68”(1727mm)	VZCE-6800-ANNG	384.43	438.96
76”(1930mm)	VZCE-7600-ANNG	420.83	482.40

End-of-Run Steel Trim Bottom Bracket Clip

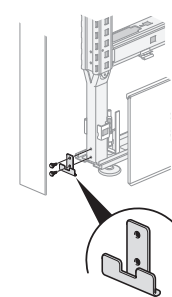

VZCE-0000-H
Class BC

Features

- Includes five attachment clips and hardware.
- Clip recommended to secure bottom of steel End-of-Run cover to panel frame.

Specification Tip

- Steel End-of-Run trim only.

To Order, Specify:

- 1) Product number.
(No color specification required.)

Number	Price
VZCE-0000-H	\$74.99

Panel Accessories

Full Panel

Trim and Corner Connectors — Steel, Aluminum, Wood

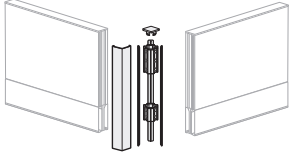

VZCL



VZCT



VZCX

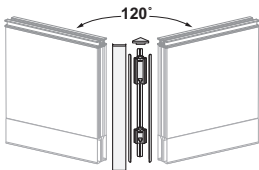

VZCV-A

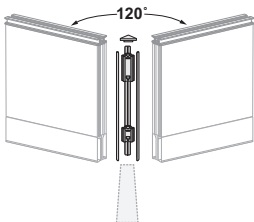

VZCY-A
Class BC

Features

- Includes thin profile steel, full profile aluminum or wood corner top cap, attachment hardware, corner blocks, spacers and light blocks.
- 90° 2- and 3-Way and 120° 2-Way connectors also include trim cover.
- Aluminum and wood top trim are 0.25" (6mm) thick; steel top trim is 0.125" (3mm) thick; 3" (76mm) D.

Specification Tips

- For variable height situations, refer to Specification Guide for Planning with Intersections.
- Mixing steel top trim with wood or aluminum not recommended.
- Standard trim guidelines apply to Open Base.

To Order, Specify:

1) Product number, including:

① **Option:**

H Steel

A Aluminum

W Wood

2) Trim color or wood finish color for vertical cover (if applicable).

3) Trim color or wood finish color for top cap.

Panel Accessories

Full Panel

Nominal Height	Number ①	Steel (H)		Aluminum (A)		Wood (W)	
		Trim A	B	Trim A	B	Wood A	B
2-Way Intersection 90°							
26"(660mm)	VZCL-2600-■	\$ 400.90	\$ 454.27	\$ 534.04	\$ 587.41	\$ 1016.47	\$ 1131.11
34"(864mm)	VZCL-3400-■	414.66	481.79	575.48	642.61	1140.71	1282.87
42"(1067mm)	VZCL-4200-■	428.42	509.31	616.92	697.81	1264.95	1434.63
50"(1270mm)	VZCL-5000-■	442.18	536.83	658.36	753.01	1389.19	1586.39
58"(1473mm)	VZCL-5800-■	455.94	564.35	699.80	808.21	1513.43	1738.15
66"(1676mm)	VZCL-6600-■	469.70	591.87	741.24	863.41	1637.67	1889.91
74"(1880mm)	VZCL-7400-■	483.46	619.39	782.68	918.61	1761.91	2041.67
82"(2083mm)	VZCL-8200-■	497.22	646.91	824.12	973.81	1886.15	2193.43
90"(2286mm)	VZCL-9000-■	510.98	674.43	865.56	1029.01	2010.39	2345.19
3-Way Intersection 90°							
26"(660mm)	VZCT-2600-■	\$ 255.88	\$ 352.18	\$ 494.11	\$ 567.19	\$ 949.14	\$ 1054.74
34"(864mm)	VZCT-3400-■	279.96	414.10	521.63	622.23	1067.78	1192.74
42"(1067mm)	VZCT-4200-■	304.04	476.02	549.15	677.27	1186.42	1330.74
50"(1270mm)	VZCT-5000-■	328.12	537.94	576.67	732.31	1305.06	1468.74
58"(1473mm)	VZCT-5800-■	352.20	599.86	604.19	787.35	1423.70	1606.74
66"(1676mm)	VZCT-6600-■	376.28	661.78	631.71	842.39	1542.34	1744.74
74"(1880mm)	VZCT-7400-■	525.36	848.70	659.23	897.43	1660.98	1882.74
82"(2083mm)	VZCT-8200-■	549.44	910.62	686.75	952.47	1779.62	2020.74
90"(2286mm)	VZCT-9000-■	573.52	972.54	714.27	1007.51	1898.26	2158.74
4-Way Intersection 90°							
26"(660mm)	VZCX-2600-■	\$ 177.27	\$ 179.33	\$ 384.88	\$ 386.94	\$ 505.59	\$ 543.48
34"(864mm)	VZCX-3400-■	188.63	190.69	396.80	398.86	517.51	555.40
42"(1067mm)	VZCX-4200-■	199.99	202.05	408.72	410.78	529.43	567.32
50"(1270mm)	VZCX-5000-■	211.35	213.41	420.64	422.70	541.35	579.24
58"(1473mm)	VZCX-5800-■	222.71	224.77	432.56	434.62	553.27	591.16
66"(1676mm)	VZCX-6600-■	234.07	236.13	444.48	446.54	565.19	603.08
74"(1880mm)	VZCX-7400-■	245.43	247.49	456.40	458.46	577.11	615.00
82"(2083mm)	VZCX-8200-■	256.79	258.85	468.32	470.38	589.03	626.92
90"(2286mm)	VZCX-9000-■	268.15	270.21	480.24	482.30	600.95	638.84
2-Way Intersection 120°							
26"(660mm)	VZCV-2600-■	\$ 849.35	\$ 866.55	\$ 866.07	\$ 883.27		
34"(864mm)	VZCV-3400-■	912.71	936.79	929.43	953.51		
42"(1067mm)	VZCV-4200-■	976.07	1007.03	992.79	1023.75		
50"(1270mm)	VZCV-5000-■	1039.43	1077.27	1056.15	1093.99		
58"(1473mm)	VZCV-5800-■	1102.79	1147.51	1119.51	1164.23		
66"(1676mm)	VZCV-6600-■	1166.15	1217.75	1182.87	1234.47		
74"(1880mm)	VZCV-7400-■	1229.51	1287.99	1246.23	1304.71		
82"(2083mm)	VZCV-8200-■	1292.87	1358.23	1309.59	1374.95		
90"(2286mm)	VZCV-9000-■	1356.23	1428.47	1372.95	1445.19		
3-Way Intersection 120°							
26"(660mm)	VZCY-2600-■	\$ 761.69	\$ 763.33	\$ 776.69	\$ 778.33		
34"(864mm)	VZCY-3400-■	811.37	813.01	826.37	828.01		
42"(1067mm)	VZCY-4200-■	861.05	862.69	876.05	877.69		
50"(1270mm)	VZCY-5000-■	910.73	912.37	925.73	927.37		
58"(1473mm)	VZCY-5800-■	960.41	962.05	975.41	977.05		
66"(1676mm)	VZCY-6600-■	1010.09	1011.73	1025.09	1026.73		
74"(1880mm)	VZCY-7400-■	1059.77	1061.41	1074.77	1076.41		
82"(2083mm)	VZCY-8200-■	1109.45	1111.09	1109.45	1111.09		
90"(2286mm)	VZCY-9000-■	1159.13	1160.77	1174.13	1175.77		

Panel Accessories

Full Panel

Trim and Corner Connectors — Work Rail

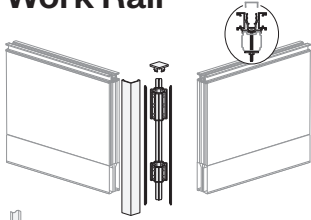

VZCL-AANG

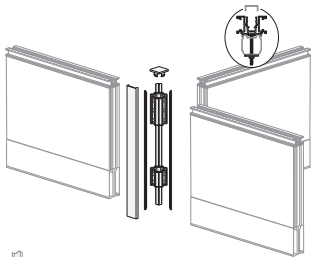

VZCT-AANG

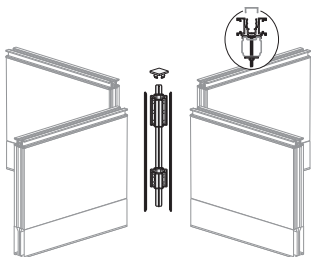

VZCX-AANG

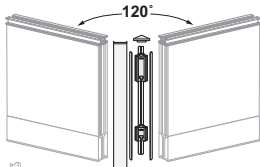

VZCV-A

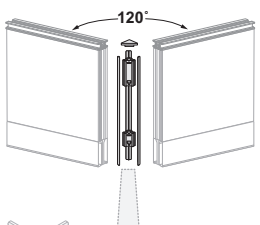

VZCY-A
Class BC

Features

- Includes full profile aluminum corner top cap, attachment hardware, corner blocks, spacers and light blocks.
- 90° 2- and 3-Way connectors and 120° 2-Way connectors also include full profile aluminum trim cover.

Specification Tips

- Connectors for use with Work Rail Top Trim not available in thin profile steel or full profile wood.
- For variable height situations, refer to Specification Guide for Planning with intersections.
- Only work rail top trim may be used adjacent to cover.

To Order, Specify:

- 1) Product number.
- 2) Trim color for vertical cover. (if applicable)
- 3) Trim color for top cap.

Nominal Height	Number	Trim A	B
2-Way Intersection 90°			
28"(711mm)	VZCL-2800-AANG	\$ 534.85	\$ 592.07
36"(914mm)	VZCL-3600-AANG	576.77	647.83
44"(1118mm)	VZCL-4400-AANG	618.69	703.59
52"(1321mm)	VZCL-5200-AANG	660.61	759.35
60"(1524mm)	VZCL-6000-AANG	702.53	815.11
68"(1727mm)	VZCL-6800-AANG	744.45	870.87
76"(1930mm)	VZCL-7600-AANG	786.37	926.63
3-Way Intersection 90°			
28"(711mm)	VZCT-2800-AANG	\$ 491.17	\$ 571.64
36"(914mm)	VZCT-3600-AANG	519.09	627.24
44"(1118mm)	VZCT-4400-AANG	547.01	682.84
52"(1321mm)	VZCT-5200-AANG	574.93	738.44
60"(1524mm)	VZCT-6000-AANG	602.85	794.04
68"(1727mm)	VZCT-6800-AANG	630.77	849.64
76"(1930mm)	VZCT-7600-AANG	658.69	905.24
4-Way Intersection 90°			
28"(711mm)	VZCX-2800-AANG	\$ 376.90	\$ 378.97
36"(914mm)	VZCX-3600-AANG	389.06	391.13
44"(1118mm)	VZCX-4400-AANG	401.22	403.29
52"(1321mm)	VZCX-5200-AANG	413.38	415.45
60"(1524mm)	VZCX-6000-AANG	425.54	427.61
68"(1727mm)	VZCX-6800-AANG	437.70	439.77
76"(1930mm)	VZCX-7600-AANG	449.86	451.93
2-Way Intersection 120°			
28"(711mm)	VZCV-2800-AANG	\$ 875.39	\$ 894.72
36"(914mm)	VZCV-3600-AANG	939.31	965.68
44"(1118mm)	VZCV-4400-AANG	1003.23	1036.64
52"(1321mm)	VZCV-5200-AANG	1067.15	1107.60
60"(1524mm)	VZCV-6000-AANG	1131.07	1178.56
68"(1727mm)	VZCV-6800-AANG	1194.99	1249.52
76"(1930mm)	VZCV-7600-AANG	1258.91	1320.48
3-Way Intersection 120°			
28"(711mm)	VZCY-2800-NANG	\$ 781.79	\$ 783.44
36"(914mm)	VZCY-3600-NANG	831.95	833.60
44"(1118mm)	VZCY-4400-NANG	882.11	883.76
52"(1321mm)	VZCY-5200-NANG	932.27	933.92
60"(1524mm)	VZCY-6000-NANG	982.43	984.08
68"(1727mm)	VZCY-6800-NANG	1032.59	1034.24
76"(1930mm)	VZCY-7600-NANG	1082.75	1084.40

Panel Accessories

Full Panel

Trim and Corner Connectors — 3- & 4-Way Intersection — Top Cap

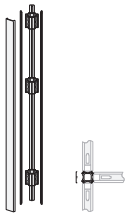
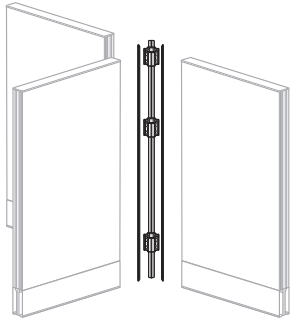

VZCT-PN



VZCX-AN
Class BC

Feature

- Includes corner blocks, attachment hardware spacers and light blocks. 3-way intersection also include full profile aluminum or wood trim cover.

Specification Tips

- Specify connectors with No Corner Top Cap when using intersection spanning top trim.
- When adding stack to panel frame, order trim cover to match overall height of panel and stack.
- For variable height situations, refer to Specification Guide for Planning with Intersections.
- When using thin profile top trim; specify full profile (A) Aluminum option.

To Order, Specify:

- 1) Product number, including:

Option:

- A** Aluminum
- W** Wood

- 2) Trim color or wood finish color. (if applicable)

Height	Number ①	Aluminum (A) Trim		Wood (W) Wood	
		A	B	A	B
3-Way Intersection					
26"(660mm)	VZCT-2600-■ N	\$442.42	\$ 483.71	\$ 866.38	\$ 958.19
34"(864mm)	VZCT-3400-■ N	469.94	524.99	985.02	1096.19
42"(1067mm)	VZCT-4200-■ N	497.46	566.27	1103.66	1234.19
50"(1270mm)	VZCT-5000-■ N	524.98	607.55	1222.30	1372.19
58"(1473mm)	VZCT-5800-■ N	552.50	648.83	1340.94	1510.19
66"(1676mm)	VZCT-6600-■ N	580.02	690.11	1459.58	1648.19
74"(1880mm)	VZCT-7400-■ N	607.54	731.39	1578.22	1786.19
82"(2083mm)	VZCT-8200-■ N	635.06	772.67	1696.86	1924.19
90"(2286mm)	VZCT-9000-■ N	662.58	813.95	1815.50	2062.19

Height	Number	Price
4-Way Intersection		
26"(660mm)	VZCX-2600-AN	\$309.05
34"(864mm)	VZCX-3400-AN	320.97
42"(1067mm)	VZCX-4200-AN	332.89
50"(1270mm)	VZCX-5000-AN	344.81
58"(1473mm)	VZCX-5800-AN	356.73
66"(1676mm)	VZCX-6600-AN	368.65
74"(1880mm)	VZCX-7400-AN	380.57
82"(2083mm)	VZCX-8200-AN	392.49
90"(2286mm)	VZCX-9000-AN	404.41

Panel Accessories

Connections

End-of-Run Trim

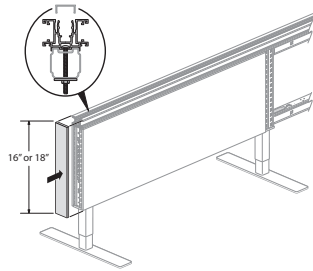

VZCE
Class BC

Feature

- Includes one vertical trim cover and attachment hardware.

Specification Tip

- Trim application specific; specify accordingly.

To Order, Specify:

- 1) Product number.
- 2) Trim color.

Top Trim Material	Height	Number	Trim A	B
Steel	16"(406mm)	VZCE-1600-HNBH	\$ 57.33	\$ 66.10
Steel Frameless Glass	16"(406mm)	VZCE-1600-HNBF	66.66	75.43
Aluminum	16"(406mm)	VZCE-1600-ANBA	147.83	156.60
Work Rail	18"(457mm)	VZCE-1800-ANBG	156.93	167.46

Raceway End-of-Run Cover

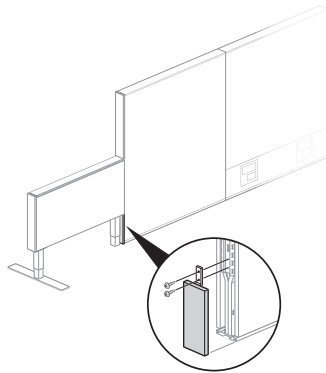

VZCE-A
Class BC

Features

- Includes one cover and attachment hardware.
- Used when attaching Connections panel to a full panel frame to cover exposed base raceway area.

Specification Tips

- For use in an In-Line condition, 2-, 3-, and 4-way 90° panel intersections, 2- and 3-way 120° panel intersections.
- Not required for all applications; refer to Specification Guide for planning with intersections.

To Order, Specify:

- 1) Product number.
- 2) Trim color.

Number	Trim A	B
VZCE-0B00-A	\$233.31	\$241.09

Panel Accessories

Connections

Trim and Corner Connectors

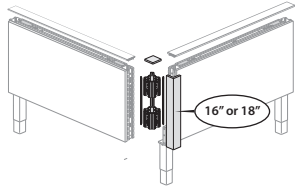

VZCL

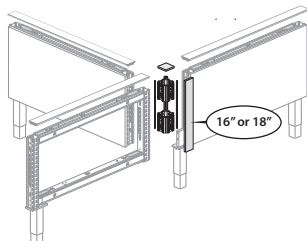

VZCT

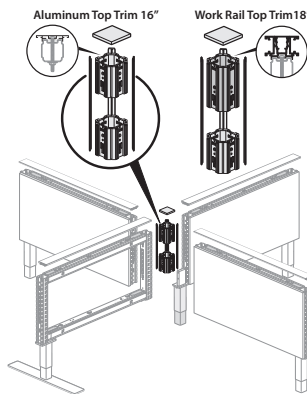

VZCX

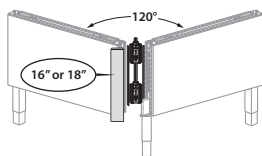

VZCV

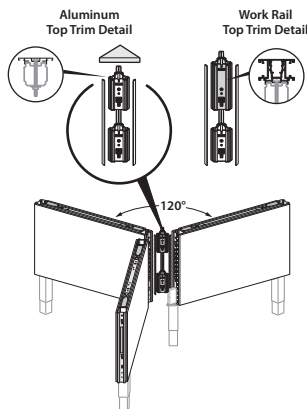

VZCY
Class BC

Features

- Includes top cap, attachment hardware, corner blocks, spacers, and light blocks.
- 90° 4-Way intersection and 120° 3-Way intersection also include vertical trim cover.

Specification Tips

- Not for use in Tile-to-Floor applications.
- For Frameless Glass and Glass Topper applications specify "For use with Aluminum Top Trim" or "For use with Steel Top Trim" option.

To Order, Specify:

- 1) Product number.
- 2) Trim color for vertical cover. (if applicable)
- 3) Trim color for top cap.

Top Trim Material	Height	Number	Trim A	B
2-Way Intersection 90°				
Aluminum	16"(406mm)	VZCL-1600-AABA	\$ 471.97	\$508.43
Steel	16"(406mm)	VZCL-1600-HHBH	276.74	313.20
Work Rail	18"(457mm)	VZCL-1800-AABG	482.45	522.37
3-Way Intersection 90°				
Aluminum	16"(406mm)	VZCT-1600-AABA	\$449.29	\$ 488.24
Steel	16"(406mm)	VZCT-1600-HHBH	223.23	262.18
Work Rail	18"(457mm)	VZCT-1800-AABG	456.27	502.14
4-Way Intersection 90°				
Aluminum	16"(406mm)	VZCX-1600-NABA	\$358.66	\$ 360.73
Steel	16"(406mm)	VZCX-1600-NHBH	164.76	166.83
Work Rail	18"(457mm)	VZCX-1800-NABG	361.70	363.77
2-Way Intersection 120°				
Aluminum	16"(406mm)	VZCV-1600-AABA	\$ 779.51	\$ 788.28
Steel	16"(406mm)	VZCV-1600-HHBH	777.78	786.55
Work Rail	18"(457mm)	VZCV-1800-AABG	795.49	806.02
3-Way Intersection 120°				
Aluminum	16"(406mm)	VZCY-1600-NABA	\$706.55	\$708.20
Steel	16"(406mm)	VZCY-1600-NHBH	706.55	708.20
Work Rail	18"(457mm)	VZCY-1800-NABG	719.09	720.74

Panel Accessories

Beam

End-of-Run Trim

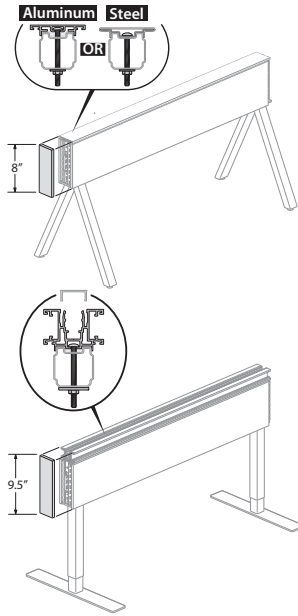

VZCE
Class BC

Feature

- Includes one vertical trim cover and attachment hardware.

Specification Tip

- End-of-Run vertical trim covers are application specific; specify accordingly.

To Order, Specify:

- 1) Product number.
- 2) Trim color.

Top Trim Material	Height	Number	Trim A	B
Steel	8"(203mm)	VZCE-0800-HNBH	\$228.77	\$230.50
Steel Frameless Glass	8"(203mm)	VZCE-0800-HNBF	238.10	239.83
Aluminum	8"(203mm)	VZCE-0800-ANBA	141.43	143.16
Work Rail	10"(254mm)	VZCE-1000-ANBG	155.53	159.02

Panel Accessories

Beam

Trim and Corner Connectors

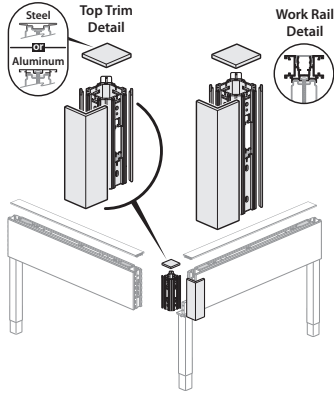

VZCL

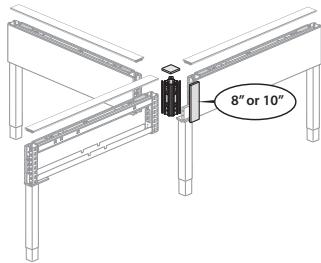

VZCT

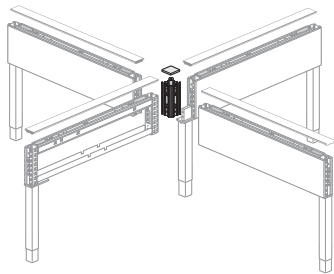

VZCX
Class BC

Feature

- Includes top cap, attachment hardware, corner block, spacers, and light blocks. 2- and 3-Way intersection also include one vertical trim cover.

To Order, Specify:

- Product number.
- Trim color for vertical cover. (if applicable)
- Trim color for top cap.

Top Trim Material	Height	Number	Trim A	B
2-Way Intersection 90°				
Steel	8"(203mm)	VZCL-0800-HHBH	\$442.90	\$465.52
Aluminum	8"(203mm)	VZCL-0800-AABA	460.05	482.67
Work Rail	10"(254mm)	VZCL-1000-AABG	475.53	501.61
3-Way Intersection 90°				
Steel	8"(203mm)	VZCT-0800-HHBH	\$ 383.71	\$394.98
Aluminum	8"(203mm)	VZCT-0800-AABA	451.37	462.64
Work Rail	10"(254mm)	VZCT-1000-AABG	463.35	481.54
4-Way Intersection 90°				
Steel	8"(203mm)	VZCX-0800-NHBH	\$ 333.24	\$ 335.31
Aluminum	8"(203mm)	VZCX-0800-NABA	376.50	378.57
Work Rail	10"(254mm)	VZCX-1000-NABG	384.54	386.61

Panel Accessories

Beam

Trim and Corner Connectors — No Top Cap

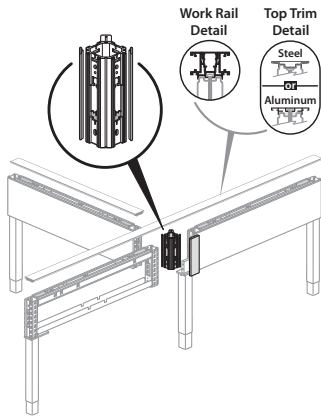

VZCT

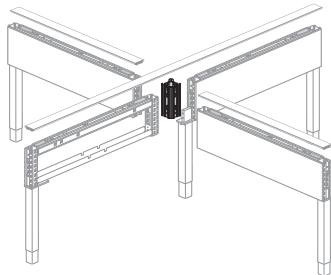

VZCX
Class BC

Features

- Includes attachment hardware, corner block, spacers and light blocks.
- 3-Way intersection also includes one vertical trim cover.
- Does not include a corner top cap.

Specification Tips

- No top cap option used when specifying intersection spanning top trim widths.
- Not for use with spanning tiles.

To Order, Specify:

- 1) Product number.
- 2) Trim color for vertical cover. (if applicable)

Top Trim Material	Height	Number	Trim A	B
3-Way Intersection				
Steel	8"(203mm)	VZCT-0800-HNBN	\$331.48	\$ 341.94
Aluminum	8"(203mm)	VZCT-0800-ANBN	399.14	409.60

Top Trim Material	Height	Number	Price
4-Way Intersection			
Steel or Aluminum	8"(203mm)	VZCX-0800-NNBN	\$299.88

Steel Trim Top Cap Aligner Clip

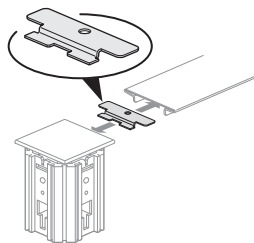

VZCC-0000-H
Class BC

Features

- Includes five black attachment clips.
- For use in corner intersections to align steel top trim to the corner cap.

Specification Tips

- Steel top trim only.
- Clip recommended for alignment.
- Not for use in 120° corners.

To Order, Specify:

- 1) Product number. (No color specification required.)

Number	Price
VZCC-0000-H	\$83.30

Panel Accessories

Variable Height Trim — Proud

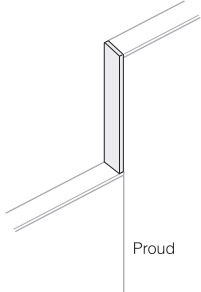

VZVE
Class BC

Feature

- Includes thin profile steel, full profile aluminum, or wood variable height (Proud) cover and attachment hardware.

Specification Tips

- For use with multiple panel heights in in-line condition.
- Cover height is difference between tall and short panel.
- Variable height trim attaching directly to a panel frame will add 0.125"(3mm) (steel) or 0.25"(6mm) (aluminum or wood) to panel width.
- May be used in intersection conditions. Refer to Specification Guide for Planning with Intersections.

To Order, Specify:

- 1) Product number.
- 2) Trim or wood finish color.

Note: For Steel/Frameless Glass Top Trim, change the Steel option -H to a -F and (add **\$19.60** list).
Example: VZVE-0800-H to VZVE-0800-F

Height	Number	Trim/Wood	
		A	B
For use with Aluminum Top Trim			
8"(203mm)	VZVE-0800-A	\$ 173.60	\$ 174.46
16"(406mm)	VZVE-1600-A	202.56	210.30
24"(610mm)	VZVE-2400-A	231.52	246.14
32"(813mm)	VZVE-3200-A	260.48	281.98
40"(1016mm)	VZVE-4000-A	289.44	317.82
48"(1219mm)	VZVE-4800-A	318.40	353.66
For use with Steel Top Trim			
8"(203mm)	VZVE-0800-H	\$ 46.82	\$ 47.68
16"(406mm)	VZVE-1600-H	56.42	64.16
24"(610mm)	VZVE-2400-H	66.02	80.64
32"(813mm)	VZVE-3200-H	75.62	97.12
40"(1016mm)	VZVE-4000-H	85.22	113.60
48"(1219mm)	VZVE-4800-H	94.82	130.08
For use with Wood Top Trim			
8"(203mm)	VZVE-0800-W	\$ 395.71	\$ 435.24
16"(406mm)	VZVE-1600-W	500.03	558.68
24"(610mm)	VZVE-2400-W	604.35	682.12
32"(813mm)	VZVE-3200-W	708.67	805.56
40"(1016mm)	VZVE-4000-W	812.99	929.00
48"(1219mm)	VZVE-4800-W	917.31	1052.44
For use with Lowest Frame with Work Rail to Taller Frame with Aluminum Top Trim			
14"(356mm)	VZVE-1400-ANGA	\$ 182.07	\$ 188.23
22"(559mm)	VZVE-2200-ANGA	211.27	224.47
30"(762mm)	VZVE-3000-ANGA	240.47	260.71
38"(965mm)	VZVE-3800-ANGA	269.67	296.95
46"(1168mm)	VZVE-4600-ANGA	298.87	333.19
For use with Lowest Frame with Aluminum Top Trim to Taller Frame with Work Rail			
10"(254mm)	VZVE-1000-ANAG	\$ 202.47	\$ 205.11
18"(457mm)	VZVE-1800-ANAG	196.67	206.35
26"(660mm)	VZVE-2600-ANAG	225.87	242.59
34"(864mm)	VZVE-3400-ANAG	255.07	278.83
42"(1067mm)	VZVE-4200-ANAG	284.27	315.07
50"(1270mm)	VZVE-5000-ANAG	313.47	351.31
For use with Work Rail Top Trim to Work Rail Top Trim			
8"(203mm)	VZVE-0800-ANGG	\$ 190.17	\$ 191.05
16"(406mm)	VZVE-1600-ANGG	189.37	197.29
24"(610mm)	VZVE-2400-ANGG	218.57	233.53
32"(813mm)	VZVE-3200-ANGG	247.77	269.77
40"(1016mm)	VZVE-4000-ANGG	276.97	306.01
48"(1219mm)	VZVE-4800-ANGG	306.17	342.25

Panel Accessories

Variable Height Trim 3-Way & 4-Way — Flush 90°

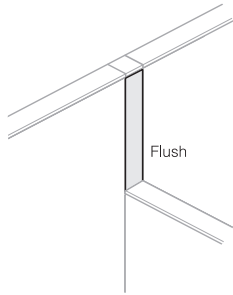

VZVT
Class BC

Feature

- Includes one thin profile steel, full profile aluminum or wood variable height cover (Flush), corner block, and attachment hardware.

Specification Tips

- For use with multiple panel heights in a 3-way or 4-way or panel intersection.
- Used in a variable height condition between Compose Connections panel(s) and Compose panel.
- For use with Compose panels up to 74"(1880mm)H.
- Cover height is difference between tall and short panel.
- Use 2"(51mm) less variable height trim when connecting Compose Connections frame with Work Rail Top Trim to full height Compose panel.
- 3-Way/4-Way wood trim (Flush) for use with in-line applications only.
- Refer to Specification Guide for planning with intersections.

To Order, Specify:

- 1) Product number.
- 2) Trim or wood finish color.

Top Trim Material	Height	Number	Trim/Wood	
			A	B
Steel	8"(203mm)	VZVT-0800-H	\$ 115.53	\$ 116.39
	16"(406mm)	VZVT-1600-H	127.05	134.79
	24"(610mm)	VZVT-2400-H	138.57	153.19
	32"(813mm)	VZVT-3200-H	150.09	171.59
	40"(1016mm)	VZVT-4000-H	161.61	189.99
	48"(1219mm)	VZVT-4800-H	173.13	208.39
Aluminum	8"(203mm)	VZVT-0800-A	\$ 223.63	\$ 224.49
	16"(406mm)	VZVT-1600-A	247.23	254.97
	24"(610mm)	VZVT-2400-A	270.83	285.45
	32"(813mm)	VZVT-3200-A	294.43	315.93
	40"(1016mm)	VZVT-4000-A	318.03	346.41
	48"(1219mm)	VZVT-4800-A	341.63	376.89
Work Rail	14"(356mm)	VZVT-1400-ANGA	\$ 228.58	\$ 234.74
	22"(559mm)	VZVT-2200-ANGA	252.42	265.62
	30"(762mm)	VZVT-3000-ANGA	276.26	296.50
	38"(965mm)	VZVT-3800-ANGA	300.10	327.38
	46"(1168mm)	VZVT-4600-ANGA	323.94	358.26
	Wood	8"(203mm)	VZVT-0800-W	\$359.83
	16"(406mm)	VZVT-1600-W	460.55	511.63
	24"(610mm)	VZVT-2400-W	561.27	635.87
	32"(813mm)	VZVT-3200-W	661.99	760.11
	40"(1016mm)	VZVT-4000-W	762.71	884.35
	48"(1219mm)	VZVT-4800-W	863.43	1008.59

Variable Height Trim (Flush) — 120°



VZVY
Class BC

Feature

- Includes full profile aluminum or thin profile steel vertical trim (flush fit), corner block with spacers and mounting hardware.

Specification Tips

- For use with multiple panel heights in 3-way condition.
- Variable height trim attaching to a corner block will be a flush fit.
- Refer to Planning with Compose 120° Intersections.

To Order, Specify:

- 1) Product number.
- 2) Trim color.

Top Trim Material	Height	Number	Trim	
			A	B
Steel	8"(203mm)	VZVY-0800-H	\$256.08	\$ 257.85
	16"(406mm)	VZVY-1600-H	268.44	277.29
	24"(610mm)	VZVY-2400-H	280.80	296.73
	32"(813mm)	VZVY-3200-H	293.16	316.17
	40"(1016mm)	VZVY-4000-H	305.52	335.61
	48"(1219mm)	VZVY-4800-H	317.88	355.05
Aluminum	8"(203mm)	VZVY-0800-A	\$256.08	\$ 257.85
	16"(406mm)	VZVY-1600-A	268.44	277.29
	24"(610mm)	VZVY-2400-A	280.80	296.73
	32"(813mm)	VZVY-3200-A	293.16	316.17
	40"(1016mm)	VZVY-4000-A	305.52	335.61
	48"(1219mm)	VZVY-4800-A	317.88	355.05

Panel Accessories

Corner Block Assembly – 90°

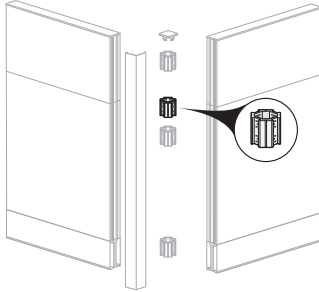

VZCS-0000
Class BC

Feature

- Includes one 90° corner block with spacers, alignment pin, and panel connection kit (bolt and nut).

Specification Tip

- One corner block per intersection (2-, 3-, or 4-way) will be required for each level of stacks (stack frame or glass stack) at the intersection.
- Not for use with Beam.

To Order, Specify:

- 1) Product number.
(No finish specification required.)

Note: When reconfiguring with product prior to 2009; specify service part# 2922-4629 when adding corner blocks in the top position. (Current block will work in the bottom or middle position.)

Height	For use with	Number	Price
Fits all heights	Steel/Aluminum top trim	VZCS-0000	\$ 64.17
	Wood top trim	VZCS-0000-W	80.23

Corner Block Assembly — 120°

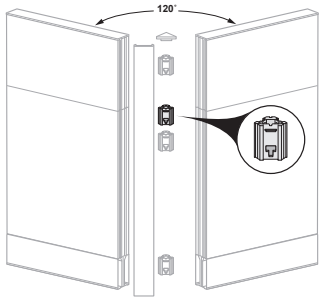

VZCY-0000
Class BC

Feature

- Includes one 120° corner block with spacers, alignment pin, and panel connection kit (bolt and nut).

Specification Tip

- One corner block per intersection (2- or 3-way) will be required for each level of stacks (stack frame or glass stack) at the intersection.
- Not for use with Beam.

To Order, Specify:

- 1) Product number.
(No finish specification required.)

Height	Number	Price
Fits all heights	VZCY-0000	\$ 105.19

3-Way Intersection — Spanning Tile Corner Blocks

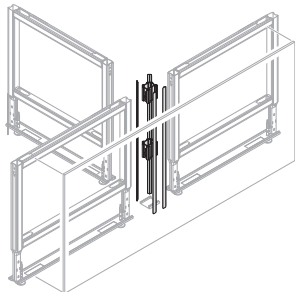

VZCT
Class BC

Feature

- Includes attachment hardware, corner blocks, light blocks. Full Panel also includes a spanning raceway pan.

Specification Tips

- For use with separately specified 3-Way Intersection Spanning Tile and spanning top trim.
- Not for use with 3-Way Intersection Full Panel Trim.
- Not for use with Tile-to-Floor.
- Prevents power routing.

To Order, Specify:

- 1) Product number.
- 2) Trim color, if applicable.
(Full Panel only.)

Height	Number	Price
Beam		
8"(203mm)	VZCT-0800-NSBN	\$304.24
Connections		
16"(406mm)	VZCT-1600-NSBN	\$ 316.41

Full Panel	Number	Trim	
		A	B
26"(660mm)	VZCT-2600-NS	\$ 316.41	\$ 324.19
34"(864mm)	VZCT-3400-NS	316.41	324.19
42"(1067mm)	VZCT-4200-NS	339.77	347.55
50"(1270mm)	VZCT-5000-NS	363.13	370.91
58"(1473mm)	VZCT-5800-NS	386.49	394.27
66"(1676mm)	VZCT-6600-NS	409.85	417.63
74"(1880mm)	VZCT-7400-NS	433.21	440.99
82"(2083mm)	VZCT-8200-NS	456.57	464.35
90"(2286mm)	VZCT-9000-NS	479.93	487.71

Panel Accessories

Aligner/Light Block

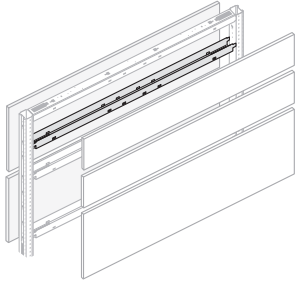

VZAL
Class BC

Features

- Includes one Aligner/Light Block.
- Black finish.
- Aligner/light blocks are required and separately specified based upon segmented tile configuration.

Specification Tips

- Specify when horizontal aligner/light block is needed between adjacent tiles.
- Aligner/light blocks can be specified separately for increased rigidity for full-height fabric tiles or as a light block for segmented tiles for all tile surfaces.
- Refer to Specification Guide for Planning with Tiles.

To Order, Specify:

- 1) Product number.
(No finish specification required.)

Width	Number	Price
18"(457mm)	VZAL-0018	\$ 72.42
24"(610mm)	VZAL-0024	75.99
30"(762mm)	VZAL-0030	79.54
36"(914mm)	VZAL-0036	83.12
42"(1067mm)	VZAL-0042	86.67
48"(1219mm)	VZAL-0048	90.22
54"(1372mm)	VZAL-0054	93.79
60"(1524mm)	VZAL-0060	97.34
72"(1829mm)	VZAL-0072	154.51

Half Aligner/Light Block

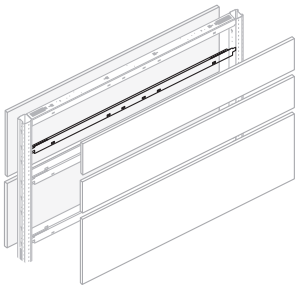

VZAL
Class BC

Features

- Includes one Half Aligner/Light Block.
- Black finish.

Specification Tips

- For use when tile reveal falls directly behind power location when power is accessed on one side only. Refer to Specification Guide.
Example: 16"(406mm)H Technology Tile on one side of frame and two 8"(203mm)H tiles on the other side of the frame.
- Specify when horizontal light block is needed between adjacent tiles.
- Refer to Specification Guide for Planning with Tiles.

To Order, Specify:

- 1) Product number.
(No finish specification required.)

Width	Number	Price
24"(610mm)	VZAL-0024-1	\$188.90
30"(762mm)	VZAL-0030-1	199.51
36"(914mm)	VZAL-0036-1	210.12
42"(1067mm)	VZAL-0042-1	220.73
48"(1219mm)	VZAL-0048-1	231.34
54"(1372mm)	VZAL-0054-1	241.95
60"(1524mm)	VZAL-0060-1	252.56
72"(1829mm)	VZAL-0072-1	391.93

Panel Accessories

Vertical Light Block (Between Panel)

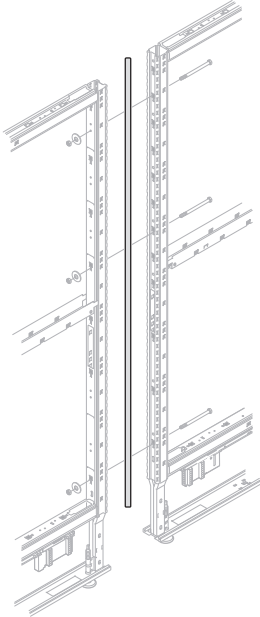

VZAL-1600
Class BC

Features

- Includes one Vertical Light Block.
- Blocks light between panels joined in straight (in-line) conditions.

Specification Tips

- Specify Vertical Light Block in straightline condition as required. Refer to Specification Guide for suggested applications.
- Specify Vertical Light Block height equal to the total height of the panel and/or stack frame configuration.
- For Connections Tile-to-Floor applications, specify VZAL-3400. Requires field cutting to appropriate height.
- Not for use with Glass Panels or Glass Stack Frames.

To Order, Specify:

- 1) Product number.
(No finish specification required.)

Height	Number	Price
16"(406mm)	VZAL-1600	\$ 7.13
34"(864mm)	VZAL-3400	7.13
42"(1067mm)	VZAL-4200	7.13
50"(1270mm)	VZAL-5000	7.13
58"(1473mm)	VZAL-5800	8.91
66"(1676mm)	VZAL-6600	8.91
74"(1880mm)	VZAL-7400	8.91
82"(2083mm)	VZAL-8200	10.69
90"(2286mm)	VZAL-9000	10.69

Panel Accessories

Friction Pad

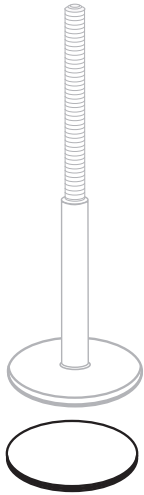

7031-0501
Class BC

Feature

- Includes one pad.

Specification Tip

- Attaches to bottom or foot of glide to prevent movement of panels on hard surface flooring.

To Order, Specify:

- 1) Product number.
(No finish specification required.)

Number	Price
7031-0501	\$18.94

Seismic Anchoring Kit

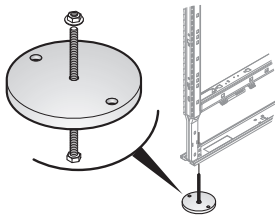

VZSB-0000
Class BC

Features

- Includes one black 5"(127mm) round steel seismic bracket, one 0.375"(10mm)"-16 x 5"(127mm) grade 8 bolt, one 0.375"(10mm) hardened flat washer, and one grade 8 serrated flange nut.
- When used as described in Department of Health Care Access and Information (HCAI) pre-approval OPM-0232-13 documentation the anchoring kit will allow for the installation of Compose product in California Hospitals.

Specification Tips

- The kit replaces the glide.
- Requires field drilling of the floor for installation.
- Requires separately specified expansion anchors to secure seismic bracket to deck or slab as described in OPM-0232-13 which is located on the HCAI website for the state of California.
- Expansion anchors are supplied by others.
- Not for use with Connections.
- If X Series Drawer Pedestals are used to support Compose Panels, they are to be secured as described in OPM-0232-13; requires separately specified expansion anchors which are supplied by others.
- Review HCAI OPM-0232-13 to determine the quantity of kits required for application.

To Order, Specify:

- 1) Product number.
(No finish specification required.)

Number	Price
VZSB-0000	\$414.65

Anchoring Bracket

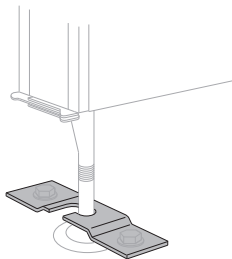

HAB
Class BC

Features

- Includes package of six formed steel brackets.
- For anchoring of panels.

Specification Tip

- Does not fulfill requirements for Department of Health Care Access and Information (HCAI) for the state of California.

To Order, Specify:

- 1) Product number.
(No finish specification required.)

Number	Price
HAB-0001	\$333.05

Panel Accessories

T-Mount

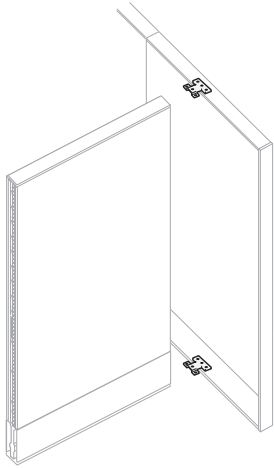

VZCM-P

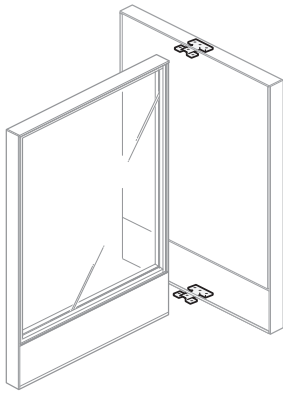

VZCM-G
Class BC

Features

- Includes top and bottom mounting brackets and hardware.
- Black finish.

Specification Tips

- Panels must be equal height except when T-mounting into a spinewall with a glass stack. In this condition, the T-mounted panel must be equal in height to the panel below the glass stack.
- The spinewall can only be a standard frame with or without a glass stack, the T-mounted panel can be standard or glass frame.
- Not compatible with thin profile steel trim or open base option.

To Order, Specify:

- 1) Product number.
(No finish specification required.)

Height	Description	Number	Price
Fits all heights	Panel frame	VZCM-0000-P	\$ 238.11
	Glass frame	VZCM-0000-G	238.11

Panel Accessories

Panel Frame Wall Mount

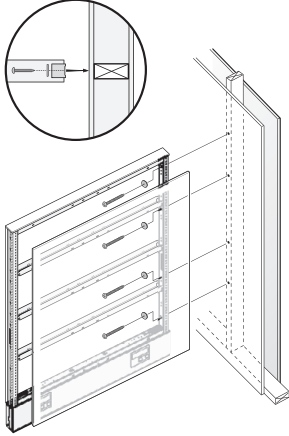

VZCW-0000-P
Class BC

Features

- Includes attachment hardware.
- For mounting panels frames, with or without stack, to a structural wall.

Specification Tips

- For use with Full Panel, Connections and Beam.
- Must be properly anchored to a structural wall.
- When using wall mount in combination with wall track, refer to Specification Guide.

To Order, Specify:

- 1) Product number.
(No finish specification required.)

Height	Number	Price
Fits all heights	VZCW-0000-P	\$123.00

Glass Panel Wall Mount

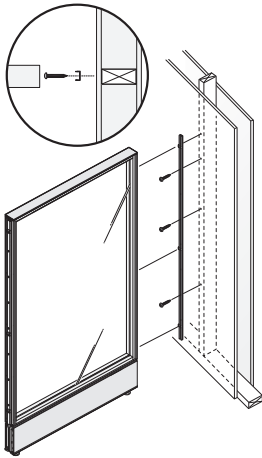

VZCW-G
Class BC

Features

- Includes wall mount channel and attachment hardware.
- For mounting glass panels to a structural wall.
- Black finish.

Specification Tip

- Must be properly anchored to a structural wall.

To Order, Specify:

- 1) Product number.
(No finish specification required.)

Height	Number	Price
42"(1067mm)	VZCW-4200-G	\$ 167.31
50"(1270mm)	VZCW-5000-G	171.00
58"(1473mm)	VZCW-5800-G	174.68
66"(1676mm)	VZCW-6600-G	178.36
74"(1880mm)	VZCW-7400-G	182.03

Tie Bracket Kit – Glass Stack

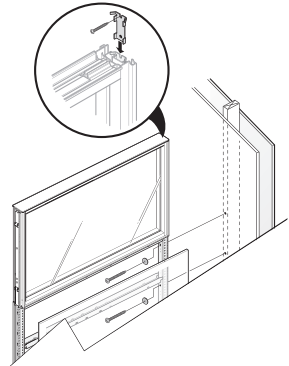

VZCQ-0000
Class BC

Features

- Includes:
 - 8 brackets
 - 8 screws (drywall attachment)
- Standard in black finish.

Specification Tips

- For use with Compose Glass Stack mounted adjacent to drywall.
- One kit required per glass stack.

To Order, Specify:

- 1) Product number.
(No finish specification required.)

Height	Number	Price
2"(51mm)	VZCQ-0000	\$ 285.16

Panel Accessories

Glass to Glass Connectors — In-Line

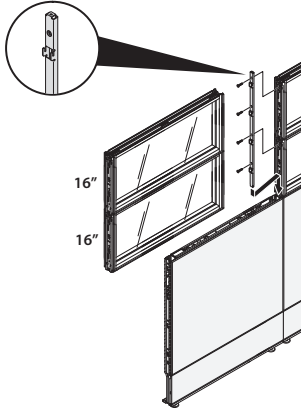

VZGS-1616-U
Class BC

Feature

- Includes one connector and attachment hardware.

Specification Tips

- For use when securing one set of two glass stacks to an adjacent set of same height glass stacks in an in-line condition.
- Specify VZGS-1616-U to secure one set of 16"(406mm)H glass stacks to an adjacent set of 16"(406mm)H glass stacks.
- Specify VZGS-1624-U to secure a set of one 16"(406mm)H and one 24"(610mm)H glass stacks to another set of 16"(406mm)H/24"(610mm)H glass stacks.
- Refer to Specification Guide for further information.

To Order, Specify:

- 1) Product number.
(No finish specification required.)

Description	Number	Price
In-Line	VZGS-1616-U	\$ 87.36
In-Line	VZGS-1624-U	103.42

Glass to Glass Connectors — End-of-Run/ Intersection

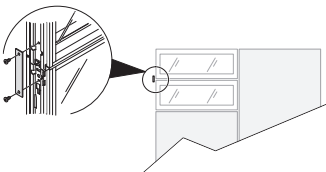

VZGS-0000-P
Class BC

Feature

- Includes a kit of 4 flat plates and attachment hardware.

Specification Tips

- One flat plate secures two glass stacks in an End-of-Run/Intersection condition.
- Refer to Specification Guide for further information.

To Order, Specify:

- 1) Product number.
(No finish specification required.)

Description	Number	Price
End-of-run/Intersection	VZGS-0000-P	44.56

Glass to Glass Connectors — Variable Height

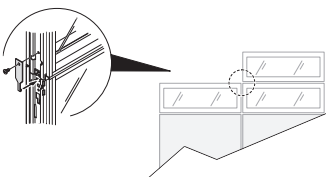

VZGS-0000-B
Class BC

Feature

- Includes a kit of 4 flat plates and attachment hardware.

Specification Tips

- One flat plate secures a set of two glass stacks to a single glass stack in a variable height application.
- Refer to Specification Guide for further information.

To Order, Specify:

- 1) Product number.
(No finish specification required.)

Description	Number	Price
Variable Height	VZGS-0000-B	114.07

Electrical Components

Base Feed Module — Hardwire Connection

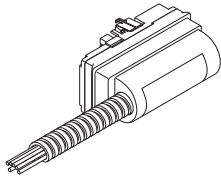

VZEB-0000-3
VZEB-0000-H2
VZEB-0000-H4



Class BC

Features

- Includes one base feed with black 0.5”(13mm) flexible galvanized steel conduit.
- Conduit for 3-Circuit includes eight 12-gauge wires for up to three 20 amp circuits of power.
- Conduit for 4-Circuit includes six 12-gauge and two 10-gauge wires for up to four 20 amp circuits of power.
- For floor, column, or wall hardwire connections.
- For use with frames equipped with power components.
- Base feed module can be field modified to accommodate left- or right-hand conditions.
- Attaches at any one of the four receptacle sites in a powered base raceway of a panel frame.
- Standard in charcoal trim color only.

Specification Tips

- **For use with 120 volt 60 hertz power sources only.**
- Not for use with tile to the floor panel applications.
- Do not mix components from different wiring configurations. Unique polarity keys and colors are used for each wiring configuration. (3 circuit=black, 2+2=blue, 3+1=green).
- Application may require approval of local authority having jurisdiction (AHJ); ensure compliance before placing orders and installation.

To Order, Specify:

- 1) Product number.
(No finish specification required.)

Description	Feed Length	Number	Price
3-Circuit			
3-Circuit Hardwire 20 Amp	48”(1219mm)	VZEB-0000-3	\$472.79
3-Circuit Hardwire 20 Amp	72”(1829mm)	VZEB-0006-H3	539.79
3-Circuit Hardwire 20 Amp	120”(3048mm)	VZEB-0010-H3	673.79
3-Circuit Hardwire 20 Amp	180”(4572mm)	VZEB-0015-H3	841.29
3-Circuit Hardwire 20 Amp	300”(7620mm)	VZEB-0025-H3	1176.29
4-Circuit, 2+2			
4-Circuit, 2+2 Hardwire 20 Amp	48”(1219mm)	VZEB-0000-H2	\$472.79
4-Circuit, 2+2 Hardwire 20 Amp	72”(1829mm)	VZEB-0006-H2	539.79
4-Circuit, 2+2 Hardwire 20 Amp	120”(3048mm)	VZEB-0010-H2	673.79
4-Circuit, 2+2 Hardwire 20 Amp	180”(4572mm)	VZEB-0015-H2	841.29
4-Circuit, 2+2 Hardwire 20 Amp	300”(7620mm)	VZEB-0025-H2	1176.29
4-Circuit, 3+1			
4-Circuit, 3+1 Hardwire 20 Amp	48”(1219mm)	VZEB-0000-H4	\$472.79
4-Circuit, 3+1 Hardwire 20 Amp	72”(1829mm)	VZEB-0006-H4	539.79
4-Circuit, 3+1 Hardwire 20 Amp	120”(3048mm)	VZEB-0010-H4	673.79
4-Circuit, 3+1 Hardwire 20 Amp	180”(4572mm)	VZEB-0015-H4	841.29
4-Circuit, 3+1 Hardwire 20 Amp	300”(7620mm)	VZEB-0025-H4	1176.29

Single Circuit Base Feed Module — Receptacle Connection with Power Cord

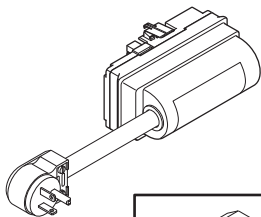

VZEB-0000-2
VZEB-0000-22
VZEB-0000-24



Class BC

Features

- Includes a single circuit power connector, 2’(610mm) cord and 20 amp plug (NEMA 5-20P).
- For use with frames equipped with power components.
- Requires a 20 amp, 125 volt power receptacle (NEMA 5-20R) for plug-in (not included).
- Attaches at any of the four receptacle sites in a powered base raceway of a panel frame.
- Provides power to circuit #1 only.
- Standard in charcoal trim color only.

Specification Tips

- **For use with 120 volt 60 hertz power sources only.**
- Not for use with:
 - Isolated ground receptacles
 - Tile to floor applications
 - Enclose
- **Not for use in Canada due to electrical code restrictions.**
- Do not mix components from different wiring configurations. Unique polarity keys and colors are used for each wiring configuration. (3 circuit=black, 2+2=blue, 3+1=green).
- Application may require approval of local authority having jurisdiction (AHJ); ensure compliance before placing orders and installation.

To Order, Specify:

- 1) Product number.
(No finish specification required.)

Description	Feed Length	Number	Price
3-Circuit Cord Feed 20 Amp (USA Only)	2’(610mm)	VZEB-0000-2	\$ 414.15
4-Circuit, 2+2 Cord Feed 20 Amp (USA Only)	2’(610mm)	VZEB-0000-22	414.15
4-Circuit, 3+1 Cord Feed 20 Amp (USA Only)	2’(610mm)	VZEB-0000-24	414.15

Electrical Components

Single Circuit Base Feed Module — Receptacle Connection with Power Cord

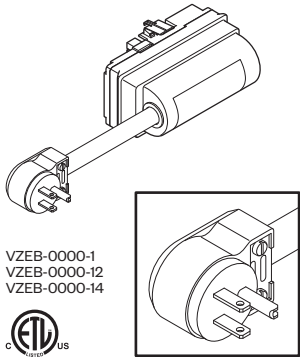

VZEB-0000-1
VZEB-0000-12
VZEB-0000-14



Class BC

Features

- Includes a single circuit power connector, 6'(1829mm) cord and 15 amp plug (NEMA 5-15P).
- For use with frames equipped with power components.
- Requires a 15 amp, 125 volt power receptacle (NEMA 5-15R) for plug-in (not included).
- Attaches at any of the four receptacle sites in a powered raceway of a panel frame.
- Provides power to circuit #1 only.
- Standard in charcoal trim color only.

Specification Tips

- **For use with 120 volt 60 hertz power sources only.**
- Not for use with:
 - Isolated ground receptacles
 - Tile to floor applications
 - Enclose
- **Not for use in USA due to electrical code restrictions.**
- Do not mix components from different wiring configurations. Unique polarity keys and colors are used for each wiring configuration. (3 circuit=black, 2+2=blue, 3+1=green).
- Application may require approval of local authority having jurisdiction (AHJ); ensure compliance before placing orders and installation.

To Order, Specify:

- 1) Product number.
(No finish specification required.)

Description	Feed Length	Number	Price
3-Circuit Cord Feed 15 Amp (Canada Only)	6'(1829mm)	VZEB-0000-1	\$489.54
4-Circuit, 2+2 Cord Feed 15 Amp (Canada Only)	6'(1829mm)	VZEB-0000-12	489.54
4-Circuit, 3+1 Cord Feed 15 Amp (Canada Only)	6'(1829mm)	VZEB-0000-14	489.54

Base Feed Module — Concealed Hardwire Connection

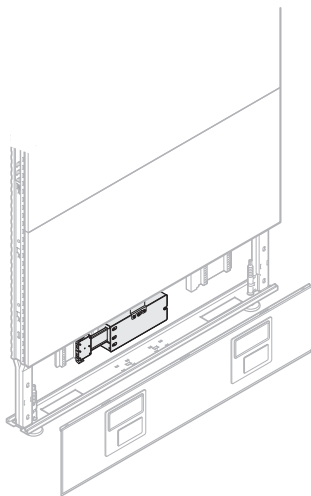

VZEB-0000-Y
VZEB-0000-YH2
VZEB-0000-YH4



Class BC

Features

- Includes one junction box with modular connector and three 0.5"(13mm) knockouts.
- For 3-Circuit includes eight 12-gauge wires for up to three 20 amp circuits of power.
- For 4-Circuit includes six 12-gauge and two 10-gauge wires for up to four 20 amp circuits of power.
- For use with frames equipped with power components.
- For floor, column, or wall hardwire connections.
- Conforms to New York City electrical code.

Specification Tips

- **For use with 120 volt 60 hertz power sources only.**
- For installation on panels **no less than 36"(914mm)W**.
- Connector plugs into receptacle site on left side of panel base.
- Not for use when routing power to Enclose.
- Conduit and fittings for connection between building and junction box are supplied by local electricians.
- Do not mix components from different wiring configurations. Unique polarity keys and colors are used for each wiring configuration. (3 circuit=black, 2+2=blue, 3+1=green).
- Application may require approval of local authority having jurisdiction (AHJ); ensure compliance before placing orders and installation.

To Order, Specify:

- 1) Product number.
(No finish specification required.)

Description	Number	Price
3-Circuit Concealed	VZEB-0000-Y	\$708.75
4-Circuit, 2+2 Concealed	VZEB-0000-YH2	708.75
4-Circuit, 3+1 Concealed	VZEB-0000-YH4	708.75

Electrical Components

Base Feed Module — Hardwire Connection

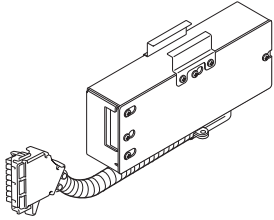

VZEB-0000-Y3U
VZEB-0000-Y2U
VZEB-0000-Y4U



Class BC

Features

- Includes one junction box with modular flexible steel conduit connector and three 0.5”(13mm) knockouts.
- Conduit for 3-Circuit includes eight 12-gauge wires for up to three 20 amp circuits of power.
- Conduit for 4-Circuit includes six 12-gauge and two 10-gauge wires for up to four 20 amp circuits of power.
- For use with frames equipped with power components.
- For floor, column, or wall hardwire connections.
- Conforms to New York City electrical code.

Specification Tips

- **For use with 120 volt 60 hertz power sources only.**
- For installation on panels **no less than 36”(914mm)W.**
- Connector plugs into receptacle site on left side of panel base.
- Conduit and fittings for connection between building and junction box are supplied by local electricians.
- Do not mix components from different wiring configurations. Unique polarity keys and colors are used for each wiring configuration. (3 circuit=black, 2+2=blue, 3+1=green).
- Application may require approval of local authority having jurisdiction (AHJ); ensure compliance before placing orders and installation.

To Order, Specify:

- 1) Product number.
(No finish specification required.)

Description	Conduit Length	Number	Price
3-Circuit	7”(178mm)	VZEB-0000-Y3U	\$790.76
4-Circuit, 2+2	7”(178mm)	VZEB-0000-Y2U	790.76
4-Circuit, 3+1	7”(178mm)	VZEB-0000-Y4U	790.76

Base Feed Module — Hardwire Connections and Beam

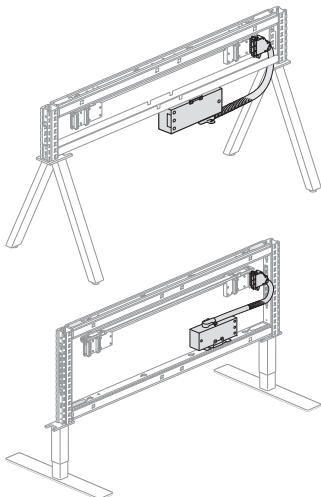

EUEB-0000-3HY
EUEB-0000-2HY
EUEB-0000-4HY



Class BC

Features

- Includes one junction box with modular connector and three 0.5”(13mm) knockouts, flexible steel conduit.
- For use with components equipped with power components.
- Conduit for 3-Circuit includes eight 12-gauge wires for up to three 20 amp circuits of power.
- Conduit for 4-Circuit includes six 12-gauge and two 10-gauge wires for up to four 20 amp circuits of power.
- For floor, column or wall hardwire connections.
- Conforms to New York City electrical code.

Specification Tips

- **For use with 120 volt 60 hertz power sources only.**
- Attaches at any receptacle site or right-hand flex connector location. Module mounts to the underside of the beam structure.
- Conduit and fittings for connection between building and junction box are supplied by local electricians.
- Do not mix components from different wiring configurations. Unique polarity keys and colors are used for each wiring configuration. (3 circuit=black, 2+2=blue, 3+1=green).

To Order, Specify:

- 1) Product number.
(No finish specification required.)

Description	Conduit Length	Number	Price
3-Circuit	20”(508mm)	EUEB-0000-3HY	\$ 452.14
4-Circuit (2+2)	20”(508mm)	EUEB-0000-2HY	452.14
4-Circuit (3+1)	20”(508mm)	EUEB-0000-4HY	452.14

Electrical Components

Internal Power Base AI Base Feed

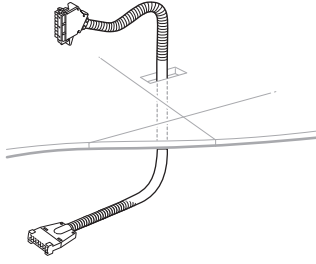

Adaptable
EUEJ-0064-3WF
EUEJ-0064-2WF
EUEJ-0064-4WF



Class SP

Features

- Includes a two port splitter and a flexible galvanized steel conduit infeed with Power Base AI connector at one end and a Power Base connector at the other end.
- Conduit for 3-Circuit includes eight 12-gauge wires for up to three 20 amp circuits of power.
- Conduit for 4-Circuit includes six 12-gauge and two 10-gauge wires for up to four 20 amp circuits of power.
- For use with frames equipped with power components.
- Allows quick connect between Compose and Power Base AI underfloor modular wiring system.
- Attaches at any one of the four receptacle sites or right-hand flex connector location.
- Connector has integral latching system.
- ETL listed Manufactured wiring system rated for 20 Amp 120V/208Y or 120/240V 60 hertz and for use in "other air handling spaces" per NEC Article 604.

Specification Tips

- **For use with 120 volt 60 hertz power sources only.**
- Can only be connected to Power Base AI under floor power system.
- Male Power Base AI connector can plug directly into a zone distribution box, circuit distributor, or flush floor box connectors.
- Male Power Base AI connector cannot connect directly to infeed or jumper. Use included circuit distributor to connect to jumper or infeed harness.
- Excess length can be coiled under the floor.
- Do not mix 3-circuit with 4-circuit components. Do not mix 2+2 and 3+1 components. Components have unique polarity key and color coding Power Base connector: (3-circuit=black, 2+2=blue and 3+1=green). Power Base AI connector: 3-circuit=rust, 4-circuit=black.
- Application may require approval of local authority having jurisdiction (AHJ); ensure compliance before placing orders and installation.

To Order, Specify:

- 1) Product number.
(No finish specification required.)

Description	Length	Number	Price
3-Circuit			
3-circuit Adaptable	64"(1626mm)	EUEJ-0064-3WF	\$ 276.75
3-circuit Adaptable	102"(2591mm)	EUEJ-0102-3WF	319.86
3-circuit Adaptable	144"(3658mm)	EUEJ-0144-3WF	384.57
3-circuit Adaptable	300"(7620mm)	EUEJ-0300-3WF	918.29
4-Circuit, 2+2			
4-circuit, 2+2 Adaptable	64"(1626mm)	EUEJ-0064-2WF	\$303.70
4-circuit, 2+2 Adaptable	102"(2591mm)	EUEJ-0102-2WF	346.81
4-circuit, 2+2 Adaptable	144"(3658mm)	EUEJ-0144-2WF	411.52
4-circuit, 2+2 Adaptable	300"(7620mm)	EUEJ-0300-2WF	945.24
4-Circuit, 3+1			
4-circuit, 3+1 Adaptable	64"(1626mm)	EUEJ-0064-4WF	\$303.70
4-circuit, 3+1 Adaptable	102"(2591mm)	EUEJ-0102-4WF	346.81
4-circuit, 3+1 Adaptable	144"(3658mm)	EUEJ-0144-4WF	411.52
4-circuit, 3+1 Adaptable	300"(7620mm)	EUEJ-0300-4WF	945.24

Electrical Components

Raised Floor Infeed Base Feed Module

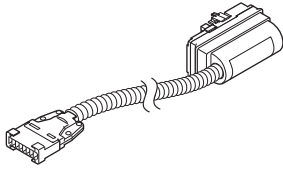

EZEJ-0048-3WF
EZEJ-0048-2WF
EZEJ-0048-4WF



Class SP

Features

- Includes one base feed with 4'(1219mm) long, black 0.5"(13mm) flexible galvanized steel conduit and a two port splitter.
- Conduit for 3-Circuit includes eight 12-gauge wires for up to three 20-amp circuits of power.
- Conduit for 4-Circuit includes six 12-gauge and two 10-gauge wires for up to four 20-amp circuits of power.
- For use with frames equipped with power components.
- Allows quick connect between Compose and Power Base AI underfloor modular wiring system.
- Base feed module can be field modified to accommodate left or right conditions.
- Attaches at any one of the four receptacle sites in a powered base raceway of a panel frame.
- Standard in charcoal trim color only.

Specification Tips

- **For use with 120 volt 60 hertz power sources only.**
- Not for use with tile to the floor applications.
- Do not mix components from different wiring configurations. Unique polarity keys and colors are used for each wiring configuration. (3 circuit=black, 2+2=blue, 3+1=green).
- Application may require approval of local authority having jurisdiction (AHJ); ensure compliance before placing orders and installation.

To Order, Specify:

- 1) Product number.
(No finish specification required.)

Description	Feed Length	Number	Price
3-Circuit Raised Floor	4'(1219mm)	EZEJ-0048-3WF	\$472.62
4-Circuit, 2+2 Raised Floor	4'(1219mm)	EZEJ-0048-2WF	998.87
4-Circuit, 3+1 Raised Floor	4'(1219mm)	EZEJ-0048-4WF	998.87

Wall Feed Field Wired 1 Port

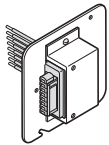

FBEW-0004-31
FBEW-0004-41



Class SP

Features

- Includes 4.6875"(119mm) junction box cover with one female modular power connector.
- For use with field supplied 4.6875"(119mm) square junction box.
- Connector has integral latching system.
- UL listed Manufactured wiring system rated for 20 Amp 120V/208Y or 120/240V 60 Hz and for use in "other air handling spaces" per NEC Article 604.

Specification Tips

- For use with Raised Floor Infeed Base Feed Module and Internal Power Base AI Base Feed.
- Provides transition from building power to modular power distribution system. May be used with junction box in wall or column.
- Do not mix 3-circuit with 4-circuit components. Do not mix 2+2 and 3+1 components. Components have unique polarity key and color coding (3-circuit=rust and 4-circuit=black).

To Order, Specify:

- 1) Product number.
(No finish specification required.)

Description	Height	Length	Number	Price
3-Circuit	1.5"(38mm)	4.6875"(119mm)	FBEW-0004-31	\$ 113.32
4-Circuit	1.5"(38mm)	4.6875"(119mm)	FBEW-0004-41	113.32

Electrical Components

Top Feed Module

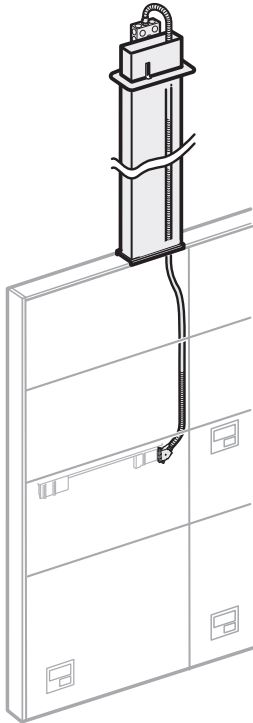

VZET-3T
VZET-2T
VZET-4T
VZET-3W
VZET-2W
VZET-4W

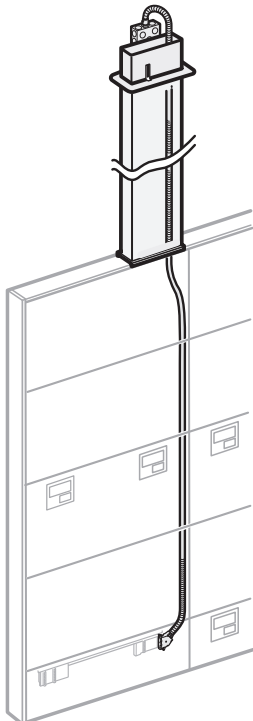

Base Raceway Connection



Class BC

Features

- Includes one electrical harness in galvanized steel conduit, electrical box, ceiling bezel plate, pole and hardware.
- For connection to the electrical source located in space above a drop ceiling.
- Electrical harness contained in galvanized steel conduit allows for adjacent routing of communication cabling within the pole.
- Removable cover on poles provides access to pathway.
- For use with frames equipped with power components.
- Conduit for 3-Circuit includes eight 12-gauge wires for up to three 20-amp circuits of power.
- Conduit for 4-Circuit includes six 12-gauge and two 10-gauge wires for up to four 20-amp circuits of power.
- Routes power to base raceway below worksurface, beltline or standing height.
- Electrical harness attaches at any receptacle site or right-hand side of panel in the flex connector location.
- 120"(3048mm) pole consists of two sections.

Specification Tips

- For routing and cabling capacities, see Specification Guide.
- For installation on panels no less than 24"(610mm)W.
- The power connector requires a flexible power connector location on the right side of the panel for attachment.
- Not for use with glass panel frames or glass stack frames.
- Mounts at the end of the panel frame.
- Does not occupy receptacle port.
- Do not mix components from different wiring configurations. Unique polarity keys and colors are used for each wiring configuration. (3 circuit=black, 2+2=blue, 3+1=green).
- Application may require approval of local authority having jurisdiction (AHJ); ensure compliance before placing orders and installation.

To Order, Specify:

1) Product number, including:

1 Trim Option

A Aluminum or Wood

H Steel

2) Trim color.

Note: Wire harness length is 180"(4572mm) regardless of pole length.

Electrical Components

Description	Panel Height	Pole Length	Number ①	Aluminum /Wood (A)/ Steel (H)		Workrail (G)	
				Trim A	B	Trim A	B
10'(3048mm) Ceiling Height							
3-Circuit	26"(660mm)	120"(3048mm)	VZET-2600-3T	\$ 1811.52	\$ 2006.13	N/A	N/A
	28"(711mm)	120"(3048mm)	VZET-2800-3TG	N/A	N/A	\$1809.66	\$2002.83
	34"(864mm)-58"(1473mm)	95"(2413mm)	VZET-3400-3T	1798.50	1983.03	N/A	N/A
	66"(1676mm)-90"(2286mm)	66"(1676mm)	VZET-6600-3T	1737.12	1874.13	N/A	N/A
4-Circuit, 2+2	26"(660mm)	120"(3048mm)	VZET-2600-2T	\$2376.98	\$ 2571.59	N/A	N/A
	28"(711mm)	120"(3048mm)	VZET-2800-2TG	N/A	N/A	\$ 2375.12	\$2568.29
	34"(864mm)-58"(1473mm)	95"(2413mm)	VZET-3400-2T	2363.96	2548.49	N/A	N/A
	66"(1676mm)-90"(2286mm)	66"(1676mm)	VZET-6600-2T	2302.58	2439.59	N/A	N/A
4-Circuit, 3+1	26"(660mm)	120"(3048mm)	VZET-2600-4T	\$2376.98	\$ 2571.59	N/A	N/A
	28"(711mm)	120"(3048mm)	VZET-2800-4TG	N/A	N/A	\$ 2375.12	\$2568.29
	34"(864mm)-58"(1473mm)	95"(2413mm)	VZET-3400-4T	2363.96	2548.49	N/A	N/A
	66"(1676mm)-90"(2286mm)	66"(1676mm)	VZET-6600-4T	2302.58	2439.59	N/A	N/A
12'(3658mm) Ceiling Height							
3-Circuit	26"(660mm)	120"(3048mm)	VZET-2600-3W	\$ 1856.16	\$2085.33	N/A	N/A
	28"(711mm)	120"(3048mm)	VZET-2800-3WG	N/A	N/A	\$1852.44	\$ 2078.73
	34"(864mm)-50"(1270mm)	120"(3048mm)	VZET-3400-3W	1841.28	2058.93	N/A	N/A
	58"(1473mm)-90"(2286mm)	95"(2413mm)	VZET-6600-3W	1781.76	1953.33	N/A	N/A
4-Circuit, 2+2	26"(660mm)	120"(3048mm)	VZET-2600-2W	\$ 2421.62	\$2650.79	N/A	N/A
	28"(711mm)	120"(3048mm)	VZET-2800-2WG	N/A	N/A	\$2417.90	\$ 2644.19
	34"(864mm)-50"(1270mm)	120"(3048mm)	VZET-3400-2W	2406.74	2624.39	N/A	N/A
	58"(1473mm)-90"(2286mm)	95"(2413mm)	VZET-6600-2W	2347.22	2518.79	N/A	N/A
4-Circuit, 3+1	26"(660mm)	120"(3048mm)	VZET-2600-4W	\$ 2421.62	\$2650.79	N/A	N/A
	28"(711mm)	120"(3048mm)	VZET-2800-4WG	N/A	N/A	\$2417.90	\$ 2644.19
	34"(864mm)-50"(1270mm)	120"(3048mm)	VZET-3400-4W	2406.74	2624.39	N/A	N/A
	58"(1473mm)-90"(2286mm)	95"(2413mm)	VZET-6600-4W	2347.22	2518.79	N/A	N/A

Electrical Components

End-of-Run Top Feed Module — Connections only

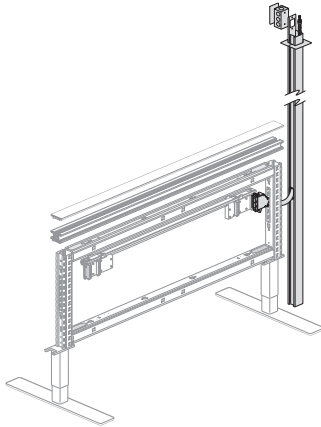

VZET-3TE
VZET-3WE



Class BC

Features

- Includes one electrical harness in galvanized steel conduit, electrical box, ceiling bezel plate, a two section pole and hardware.
- For connection to the electrical source located in space above a drop ceiling.
- Electrical harness contained in steel conduit allows for adjacent routing of communication cabling within the pole.
- Removable cover on poles provides access to pathway.
- Conduit for 3-Circuit includes eight 12-gauge wires for up to three 20 amp circuits of power.
- Conduit for 4-Circuit includes six 12-gauge and two 10-gauge wires for up to four 20 amp circuits of power.
- Attaches at any receptacle site or right-hand flex connector location.

Specification Tips

- For routing and cabling capacities, see Specification Guide.
- Mounts to the end of the Connections Frame replacing end-of-run trim.
- Specification of end-of-run trim not necessary when using End-of-Run Top Feed.
- Not for use with 2-way, 3-way or 4-way applications.
- Do not mix components from different wiring configurations. Unique polarity keys and colors are used for each wiring configuration. (3 circuit=black, 2+2=blue, 3+1=green).
- Application may require approval of local authority having jurisdiction (AHJ); ensure compliance before placing orders and installation.

To Order, Specify:

- 1) Product number.
- 2) Trim color.

Note: Wire harness length is 180”(4572mm) regardless of pole length.

Description	Pole Length	Number	Trim	
			A	B
9.5'(2896mm) Ceiling Height				
3-Circuit	120”(3048mm)	VZET-2600-3TE	\$ 2187.21	\$ 2381.82
4-Circuit, 2+2	120”(3048mm)	VZET-2600-2TE	2752.67	2947.28
4-Circuit, 3+1	120”(3048mm)	VZET-2600-4TE	2752.67	2947.28
9.5'(2896mm)-12'(3658mm) Ceiling Height				
3-Circuit	148”(3759mm)	VZET-2600-3WE	\$ 2231.85	\$ 2461.02
4-Circuit, 2+2	148”(3759mm)	VZET-2600-2WE	2797.31	3026.48
4-Circuit, 3+1	148”(3759mm)	VZET-2600-4WE	2797.31	3026.48

Electrical Components

End-of-Run Top Feed Module — Beam only

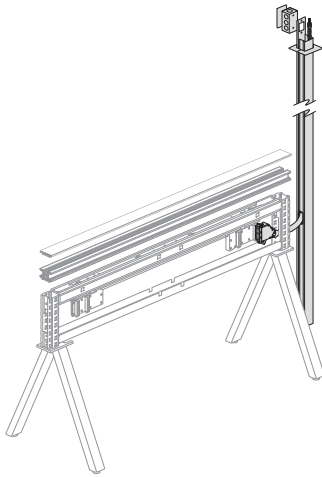

VZET-3TEJ
VZET-3WEJ



Class BC

Features

- Includes one electrical harness in galvanized steel conduit, electrical box, ceiling bezel plate, a two section pole and hardware.
- For connection to the electrical source located in space above a drop ceiling.
- Electrical harness contained in steel conduit allows for adjacent routing of communication cabling within the pole.
- Removable cover on poles provides access to pathway.
- Conduit for 3-Circuit includes eight 12-gauge wires for up to three 20 amp circuits of power.
- Conduit for 4-Circuit includes six 12-gauge and two 10-gauge wires for up to four 20 amp circuits of power.
- Attaches at any receptacle site or right-hand flex connector location.

Specification Tips

- For routing and cabling capacities, see Specification Guide.
- Mounts to the end of the Frame replacing end-of-run trim.
- Specification of end-of-run trim not necessary when using End-of-Run Top Feed.
- Not for use with 2-way, 3-way or 4-way applications.
- Do not mix components from different wiring configurations. Unique polarity keys and colors are used for each wiring configuration. (3 circuit=black, 2+2=blue, 3+1=green).

To Order, Specify:

- 1) Product number.
- 2) Trim color.

Note: Wire harness length is 180”(4572mm) regardless of pole length.

Description	Pole Length	Number	Trim	
			A	B
9.5'(2896mm) Ceiling Height				
3-Circuit	120”(3048mm)	VZET-2600-3TEJ	\$ 2187.21	\$ 2381.82
4-Circuit, 2+2	120”(3048mm)	VZET-2600-2TEJ	2752.67	2947.28
4-Circuit, 3+1	120”(3048mm)	VZET-2600-4TEJ	2752.67	2947.28
9.5'(2896mm)-12'(3658mm) Ceiling Height				
3-Circuit	148”(3759mm)	VZET-2600-3WEJ	\$ 2231.85	\$ 2461.02
4-Circuit, 2+2	148”(3759mm)	VZET-2600-2WEJ	2797.31	3026.48
4-Circuit, 3+1	148”(3759mm)	VZET-2600-4WEJ	2797.31	3026.48

Electrical Components

Full Panel Infeed Harness

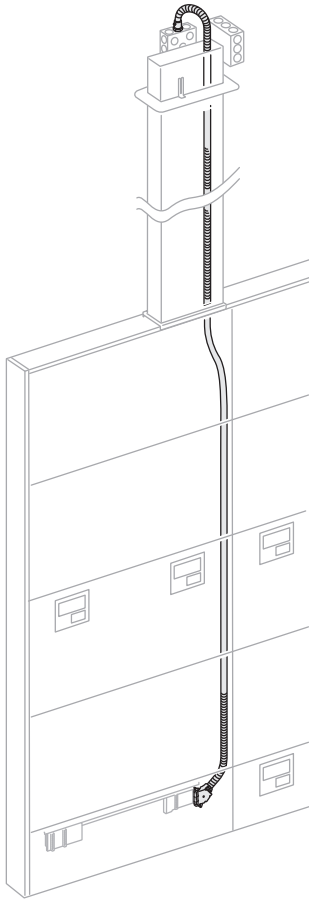

VZEH-0000
VZEH-0030



Features

- Includes electrical harness in galvanized metal conduit.
- Conduit for 3-Circuit includes eight 12-gauge wires for up to three 20-amp circuits of power.
- Conduit for 4-Circuit includes six 12-gauge and two 10-gauge wires for up to four 20-amp circuits of power.
- Attaches on right-hand side of powered panel frame to flexible power connector location.
- Routes power to base raceway, below worksurface, beltline or standing height.
- For use with panel frames when feeding from the ceiling and equipped with power components.
- Add the 3-Circuit infeed harness to a 3-Circuit top feed module or a 4-Circuit infeed to a 4-Circuit top feed module to bring additional circuits into the workstation cluster. Local electrician provides secondary junction box at top of top feed pole.

Specification Tips

- **For use with 120 volt 60 hertz power sources only.**
- Designed to work with top feeds up to 12'(3658mm) ceilings.
- For internal base feed application use Connections Infeed Harness EUEH-0087-3 for 3-circuit, EUEH-0087-2 for 4-circuit 2+2 or EUEH-0087-4 for 4-circuit 3+1.
- Not for use with glass panel frames or glass stack frames.
- Do not mix components from different wiring configurations. Unique polarity keys and colors are used for each wiring configuration. (3 circuit=black, 2+2=blue, 3+1=green).
- Application may require approval of local authority having jurisdiction (AHJ); ensure compliance before placing orders and installation.

Length	Number ①	Price
15'(4572mm)	VZEH-0000- ■	\$ 767.64
30'(9144mm)	VZEH-0030- ■	1378.49

To Order, Specify:

1) Product number, including:

① Power Option

- 3 3-Circuit
- 2 4-Circuit, 2+2 (add **\$111.07** list)
- 4 4-Circuit, 3+1 (add **\$111.07** list)

(No finish specification required.)

Note: Wire harness length is 180"(4572mm).

Infeed Harness

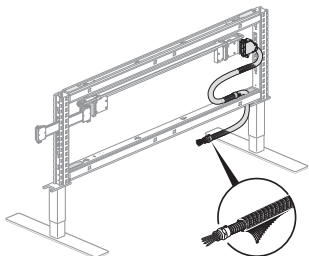

Shown with Optional Mesh Cord Manager

EUEH-0087
EUEH-00F0
EUEH-00W0



Features

- Includes electrical harness in galvanized steel conduit.
- Conduit for 3-Circuit includes eight 12-gauge wires for up to three 20 amp circuits of power.
- Conduit for 4-Circuit includes six 12-gauge and two 10-gauge wires for up to four 20 amp circuits of power.
- Attaches at any receptacle site or right-hand flex connector location.
- Routes power from floor, column or wall to power distribution assembly.
- For use with frames equipped with power components when feeding from the floor or wall.

Specification Tips

- **For use with 120 volt 60 hertz power sources only.**
- Cord Manager - Mesh may be ordered separately to cover exposed galvanized steel conduit.
- Do not mix components from different wiring configurations. Unique polarity keys and colors are used for each wiring configuration. (3 circuit=black, 2+2=blue, 3+1=green).
- Application may require approval of local authority having jurisdiction (AHJ); ensure compliance before placing orders and installation.

Length	Number ①	Price
87"(2210mm)	EUEH-0087- ■	\$ 276.75
180"(4572mm)	EUEH-00F0- ■	427.66
300"(7620mm)	EUEH-00W0- ■	720.59

To Order, Specify:

1) Product number, including:

① Power Option

- 3 3-Circuit
- 2 4-Circuit, 2+2 (add **\$26.95** list)
- 4 4-Circuit, 3+1 (add **\$26.95** list)

(No finish specification required.)

Electrical Components

Power Retrofit Kit — 42”(1067mm)H Beltline, 58”(1473mm)H Standing Height and Connections

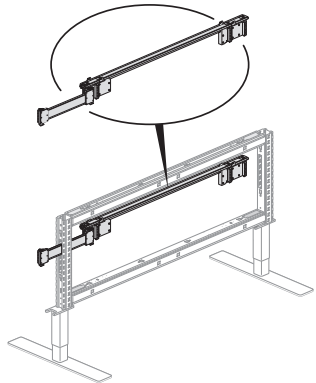
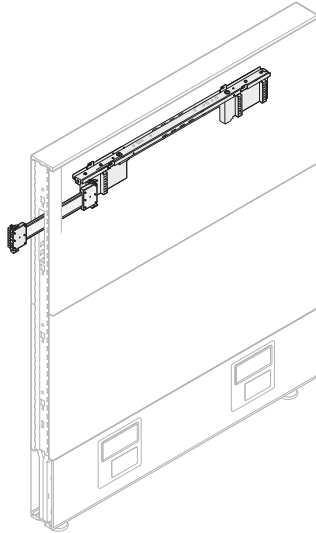

Features

- Includes power distribution assembly (PDA), flexible power connector, and PDA mounting bracket.
- Routes power through frame for 42”(1067mm)H beltline, or provides 58”(1473mm)H standing height, and Connections frame power access when used with a receptacle and technology tile or field ported fabric tile.

Specification Tips

- **Not for use with 8”(203mm) tiles.**
- Retrofit kit attaches to panel frame, does not require power crossbar for mounting power.
- For use with matching width tile with technology option.
- For vertical routing from base raceway to beltline access, specify vertical power connector which attaches to right-hand flex connection location at beltline and base raceway locations.
- PDA mounting bracket attach directly to frame.
- Do not mix components from different wiring configurations. Unique polarity keys and colors are used for each wiring configuration. (3 circuit=black, 2+2=blue, 3+1=green).

To Order, Specify:

1) Product number, including:

1 Power Option

- 3 3-Circuit
- 2 4-Circuit, 2+2
- 4 4-Circuit, 3+1

(No finish specification required.)

Panel Width	Number 1	Price
24”(610mm)	VZEK-4224-■	\$349.79
30”(762mm)	VZEK-4230-■	367.07
36”(914mm)	VZEK-4236-■	384.35
42”(1067mm)	VZEK-4242-■	401.63
48”(1219mm)	VZEK-4248-■	418.91
54”(1372mm)	VZEK-4254-■	436.19
60”(1524mm)	VZEK-4260-■	453.47
72”(1829mm)	VZEK-4272-■	713.56

VZEK-42



Class BC

Electrical Components

Power Retrofit Kit — Beltline, 50”(1270mm)H or Greater, Below WS and Standing Height

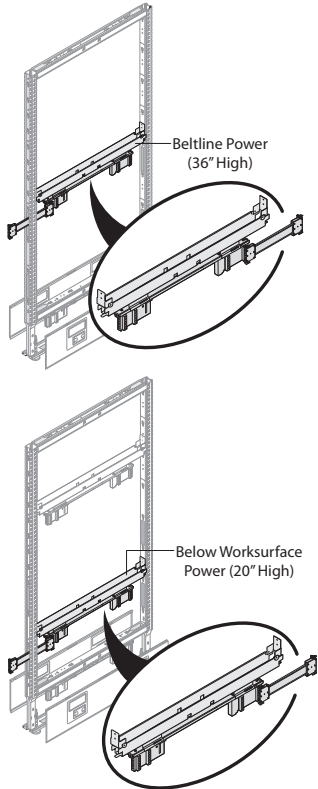

VZEK-OB



Class BC

Features

- Includes power distribution assembly (PDA), flexible power connector, PDA mounting brackets and power crossbar. Power crossbar will serve as aligner light block (not repositionable).
- Kits mounted at beltline height on 50”(1270mm) or taller frames allow for routing of power through panel or access to power when used with technology tiles or field ported fabric tiles.
- Kits mounted at below worksurface height on frames with below worksurface height openings allow for routing of power through panel or access to power when used with technology tiles or field ported fabric tiles.

Specification Tips

- **Not for use with:**
 - 8”(203mm) tiles
 - 26”(660mm) or 34”(864mm) panels below worksurface or at beltline.
 - 42”(1067mm) panels at beltline.
- Capability to route power at below worksurface height requires it to be specified with Full Panel Frame with Below Worksurface Power.
- For use with matching width tile with technology option.
- For vertical routing from base raceway to beltline or below worksurface, specify vertical power connector which attaches to right-hand flex connection location.
- Do not mix components from different wiring configurations. Unique polarity keys and colors are used for each wiring configuration. (3 circuit=black, 2+2=blue, 3+1=green).

To Order, Specify:

1) Product number, including:

1 Power Option

- 3** 3-Circuit
- 2** 4-Circuit, 2+2
- 4** 4-Circuit, 3+1

(No finish specification required.)

Panel Width	Number ①	Price
24”(610mm)	VZEK-OB24- ■	\$ 420.12
30”(762mm)	VZEK-OB30- ■	445.50
36”(914mm)	VZEK-OB36- ■	470.88
42”(1067mm)	VZEK-OB42- ■	496.26
48”(1219mm)	VZEK-OB48- ■	521.64
54”(1372mm)	VZEK-OB54- ■	547.02
60”(1524mm)	VZEK-OB60- ■	572.40
72”(1829mm)	VZEK-OB72- ■	848.69

Electrical Components

Power Retrofit Kit — Standing Height

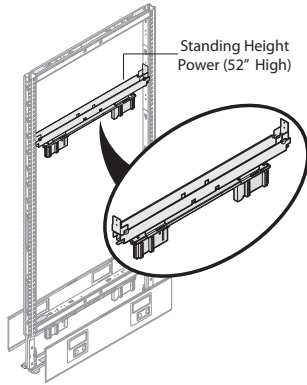

VZEP-00



Class BC

Features

- Includes power distribution assembly (PDA), PDA mounting brackets and power crossbar.
- Provides power access at standing height behind a tile with technology option specified or field ported fabric tile.

Specification Tips

- For use on 66"(1676mm)H and 74"(1880mm)H frames only.
- Not for use with 8"(203mm) tiles as they cannot be ported.
- Specify Power Connector Below Worksurface to span power horizontally from one panel equipped without below worksurface cutouts to an adjacent panel.
- For vertical routing from base raceway to below worksurface or standing height, specify vertical power connector which attaches to right-hand flex connection at each location.
- Power cannot route horizontally at standing height and requires panel frame to be powered at base raceway.
- Do not mix components from different wiring configurations. Unique polarity keys and colors are used for each wiring configuration. (3 circuit=black, 2+2=blue, 3+1=green).

To Order, Specify:

1) Product number, including:

1 Power Option

- 3 3-Circuit
- 2 4-Circuit, 2+2
- 4 4-Circuit, 3+1

(No finish specification required.)

Panel Width	Number 1	Price
24"(610mm)	VZEP-0024- <input type="checkbox"/>	\$ 398.17
30"(762mm)	VZEP-0030- <input type="checkbox"/>	420.41
36"(914mm)	VZEP-0036- <input type="checkbox"/>	442.65
42"(1067mm)	VZEP-0042- <input type="checkbox"/>	464.89
48"(1219mm)	VZEP-0048- <input type="checkbox"/>	487.13
54"(1372mm)	VZEP-0054- <input type="checkbox"/>	509.37
60"(1524mm)	VZEP-0060- <input type="checkbox"/>	551.98
72"(1829mm)	VZEP-0072- <input type="checkbox"/>	801.62

Electrical Components

Power Retrofit Kit — Raceway

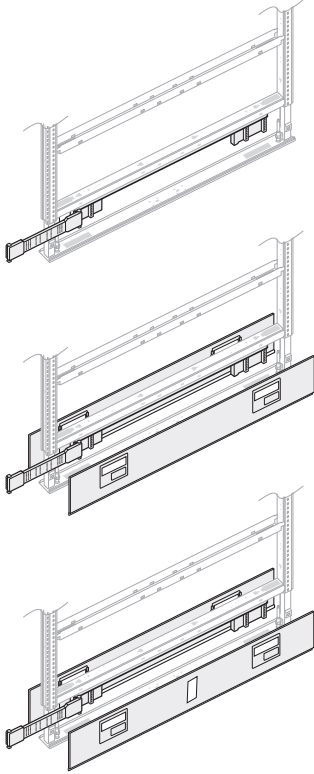

VZEK-3BB
VZEK-4BB



Class BC

Features

- Includes one power distribution assembly, one power connector, mounting hardware and optional cover(s).
- Converts non-powered frame to powered frame.

Specification Tips

- 8"(203mm) tiles cannot be used in place of base raceway cover.
- 24"(610mm) raceway covers have one knockout located on left side.
- **For single gang option, frame width must be 30"(762mm) or greater; does not include blank plate for a single gang opening.**
- Order single gang adaptor plate separately (VZAP-0000-G).
- Refer to Specification Guide for Planning with Utilities.
- **Receptacle and data blank covers must be specified separately.**
- Do not mix components from different wiring configurations. Unique polarity keys and colors are used for each wiring configuration. (3 circuit=black, 2+2=blue, 3+1=green).

To Order, Specify:

1) Product number, including:

1 Power Option

- 3 3-Circuit
- 2 4-Circuit, 2+2 (add **\$36.03** list)
- 4 4-Circuit, 3+1 (add **\$36.03** list)

2 Cover Option Side One

(see chart below for upcharges)

- N Tile to Floor
- H Cover with knockouts
- B Cover without knockouts
- G Single Gang

3 Cover Option Side Two

(see chart below for upcharges)

- N Tile to Floor
- H Cover with knockouts
- B Cover without knockouts
- G Single Gang

2) Trim color - cover side 1.

3) Trim color - cover side 2.

Cover Option	Side One		Side Two	
	Trim A	Trim B	Trim A	Trim B
H	\$135.14	\$142.50	\$135.14	\$142.50
B	135.14	142.50	135.14	142.50
G	159.25	166.61	159.25	166.61

Panel Width	Number 123	Price
24"(610mm)	VZEK-OR24- ■ ■ ■	\$ 296.28
30"(762mm)	VZEK-OR30- ■ ■ ■	314.30
36"(914mm)	VZEK-OR36- ■ ■ ■	332.32
42"(1067mm)	VZEK-OR42- ■ ■ ■	350.34
48"(1219mm)	VZEK-OR48- ■ ■ ■	368.36
54"(1372mm)	VZEK-OR54- ■ ■ ■	386.38
60"(1524mm)	VZEK-OR60- ■ ■ ■	404.40
72"(1829mm)	VZEK-OR72- ■ ■ ■	619.29

Electrical Components

Raceway Covers

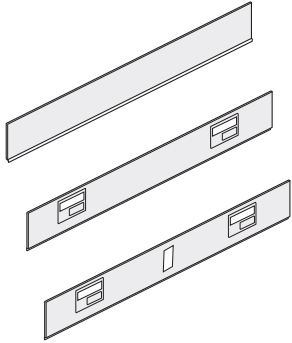

VZEK-NBB



Class BC

Feature

- Includes two single covers unless tile to floor option is specified which includes one cover.

Specification Tips

- For single gang option, panel width must be 30”(762mm) or greater. Order adaptor plate separately (VZAP-0000-G).
- 8”(203mm) tiles cannot be used in place of base raceway cover.
- 18”(457mm) raceway cover has no knockouts.
- 24”(610mm) raceway covers have one knockout located on left side.
- Refer to Specification Guide for Planning with Utilities.
- Receptacle and data blank covers must be specified separately.

To Order, Specify:

1) Product number, including:

1 Cover Option Side One

(see chart below for upcharges)

- N** Tile to Floor
- H** Cover with knockouts
- B** Cover without knockouts
- G** Single gang

2 Cover Option Side Two

(see chart below for upcharges)

- H** Cover with knockouts
- B** Cover without knockouts
- G** Single gang

2) Trim color - cover side 1.

3) Trim color - cover side 2.

Cover Option	Side One		Side Two	
	Trim A	Trim B	Trim A	Trim B
H	\$135.14	\$142.50	\$135.14	\$142.50
B	135.14	142.50	135.14	142.50
G	159.25	166.61	159.25	166.61

Panel Width	Number 1 2	Trim	
		A	B
18”(457mm)	VZEK-OR18-NBB	\$296.24	\$ 307.36
24”(610mm)	VZEK-OR24-N ■ ■	179.12	185.58
30”(762mm)	VZEK-OR30-N ■ ■	197.14	204.50
36”(914mm)	VZEK-OR36-N ■ ■	215.16	223.42
42”(1067mm)	VZEK-OR42-N ■ ■	233.18	242.34
48”(1219mm)	VZEK-OR48-N ■ ■	251.20	261.26
54”(1372mm)	VZEK-OR54-N ■ ■	269.22	280.18
60”(1524mm)	VZEK-OR60-N ■ ■	287.24	299.10
72”(1829mm)	VZEK-OR72-N ■ ■	408.81	422.47

Electrical Components

Vertical Power Connector

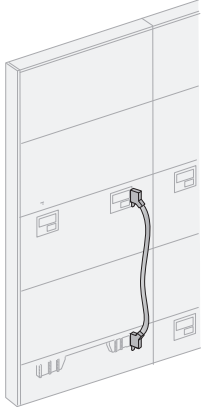

VZEJ-3



Class BC

Features

- Includes one power connector with safety latches for securing connector to power distribution assembly.
- Transfers power from the base raceway to above base raceway locations (beltline, below worksurface, standing height or beltline to below worksurface).
- The power connectors install on the right-hand side of panel into flexible power connector locations.
- For use with panels equipped with power components.

Specification Tips

- **For use with 120 volt 60 hertz power sources only.**
- **No horizontal routing is available at standing height.**
- Do not mix components from different wiring configurations. Unique polarity keys and colors are used for each wiring configuration. (3 circuit=black, 2+2=blue, 3+1=green).

To Order, Specify:

1) Product number, including:

1 Power Option

- 3 3-Circuit
- 2 4-Circuit, 2+2
- 4 4-Circuit, 3+1

(No finish specification required.)

Description	Conduit Length	Number ①	Price
Base to Below WS	13.5"(343mm)	VZEJ-OU00-█	\$ 319.27
Base to Beltline	30"(762mm)	VZEJ-OB00-█	324.46
Base to Standing Height	46"(1168mm)	VZEJ-OS00-█	331.31
Below WS to Beltline	16"(406mm)	VZEJ-UB00-█	319.27

Flexible Power Connector — Raceway

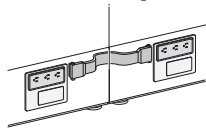

Base straight condition

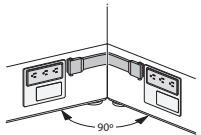

Base inside 90° condition

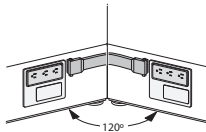

Base inside 120° condition

VZEF-OROP
VZEF-OROP-2
VZEF-OROP-4



Class BC

Features

- Includes one flexible power connector with safety latches for securing connector to power distribution assembly.
- Continues electrical circuit between adjacent powered frame in straight or angled conditions in the base raceway.
- For use with frame equipped with power components.
- May be used in straight frame-to-frame application, inside 90° and inside 120° within the base raceway.
- Standard in charcoal trim color only.

Specification Tips

- **For use with 120 volt 60 hertz power sources only.**
- Do not mix components from different wiring configurations. Unique polarity keys and colors are used for each wiring configuration. (3 circuit=black, 2+2=blue, 3+1=green).

To Order, Specify:

1) Product number.

(No finish specification required.)

Description	Length	Number	Price
3-Circuit	13.25"(337mm)	VZEF-OROP	\$ 158.46
4-Circuit, 2+2	13.25"(337mm)	VZEF-OROP-2	158.46
4-Circuit, 3+1	13.25"(337mm)	VZEF-OROP-4	158.46

Electrical Components

Flexible Power Connector — Work-height

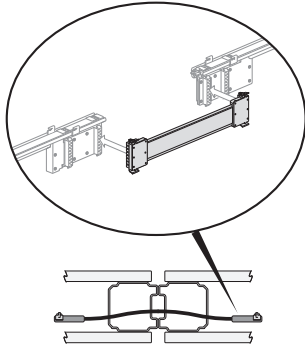

VZEF-OBOP
VZEF-OBOP-2
VZEF-OBOP-4



Class BC

Features

- Includes one flexible power connector with safety latches for securing connector to power distribution assembly.
- Continues electrical circuits between adjacent powered frames in beltline or below worksurface height straight conditions.
- For use with frames equipped with power components and frame cutouts.
- 0.95 Flexible Connectors shipped per powered frame specified.
- Standard in charcoal trim color only.

Specification Tips

- **For use with 120 volt 60 hertz power sources only.**
- Not for use with standing height applications.
- Do not mix components from different wiring configurations. Unique polarity keys and colors are used for each wiring configuration. (3 circuit=black, 2+2=blue, 3+1=green).

Description	Length	Number	Price
3-Circuit	12.5"(318mm)	VZEF-OBOP	\$ 158.46
4-Circuit, 2+2	12.5"(318mm)	VZEF-OBOP-2	158.46
4-Circuit, 3+1	12.5"(318mm)	VZEF-OBOP-4	158.46

To Order, Specify:

- 1) Product number.
(No finish specification required.)

Flexible Power Connector — Corner Span, Work-height

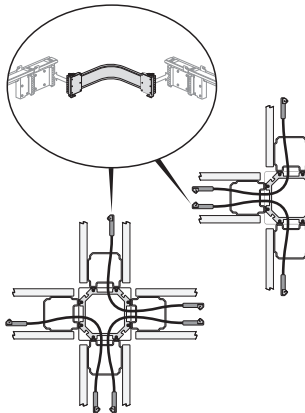

VZEF-OB0Q
VZEF-OB0Q-2
VZEF-OB0Q-4



Class BC

Features

- Includes one flexible power connector with safety latches for securing connector to power distribution assembly.
- Continues electrical circuits between adjacent powered frames in beltline or below worksurface 90° and 120° conditions.
- For use with frames equipped with power components and frame cutouts.
- For use when passing power through Compose Gallery Panels.
- Standard in charcoal trim color only.

Specification Tips

- **For use with 120 volt 60 hertz power sources only.**
- Not for use with standing height applications.
- Flexible power connector must be separately specified and is not included with panel.
- Do not mix components from different wiring configurations. Unique polarity keys and colors are used for each wiring configuration. (3 circuit=black, 2+2=blue, 3+1=green).

Description	Length	Number	Price
3-Circuit	14.5"(368mm)	VZEF-OB0Q	\$ 158.46
4-Circuit, 2+2	14.5"(368mm)	VZEF-OB0Q-2	158.46
4-Circuit, 3+1	14.5"(368mm)	VZEF-OB0Q-4	158.46

To Order, Specify:

- 1) Product number.
(No finish specification required.)

Electrical Components

Flexible Power Connector — Straight Span, Raceway/Work-height

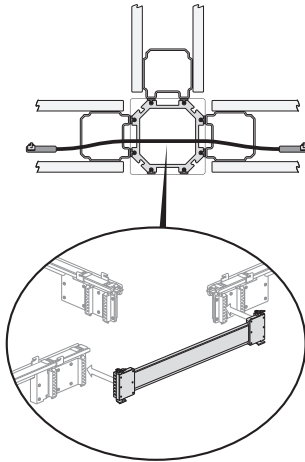

VZEF-OROS
VZEF-OROS-2
VZEF-OROS-4



Class BC

Features

- Includes one straight span flexible power connector with safety latches for securing connector to power distribution assembly.
- Continues electrical circuit across the three-inch space between powered frames in 3-way or 4-way conditions.
- For use with frames equipped with power components and frame cutouts.
- May be used at the base raceway, beltline and below worksurface for straight span conditions.
- Standard in charcoal trim color only.

Specification Tips

- **For use with 120 volt 60 hertz power sources only.**
- Not for use when passing power through Compose Gallery Panels.
- Not for use with standing height applications.
- Straight Span flexible power connector must be separately specified and is not included with panel.
- Do not mix components from different wiring configurations. Unique polarity keys and colors are used for each wiring configuration. (3 circuit=black, 2+2=blue, 3+1=green).

To Order, Specify:

- 1) Product number.
(No finish specification required.)

Description	Length	Number	Price
3-Circuit	15.5"(394mm)	VZEF-OROS	\$ 158.46
4-Circuit, 2+2	15.5"(394mm)	VZEF-OROS-2	158.46
4-Circuit, 3+1	15.5"(394mm)	VZEF-OROS-4	158.46

Extended Power Connector

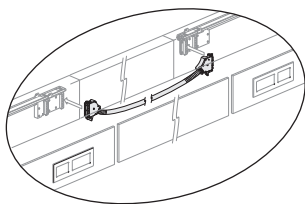

VZEJ-0018
VZEJ-0024



Class BC

Features

- Spans base power through **one** 18"(457mm) or 24"(610mm) non-powered frame located between two powered frames.
- For use with frames equipped with power components.
- Extended power connectors cannot be coupled together.
- Standard in charcoal trim with metal conduit.

Specification Tips

- **For use with 120 volt 60 hertz power sources only.**
- **Specify for use in Beam and Full Panel base raceway only.**
- Not for use with tiles to the floor.
- Do not mix components from different wiring configurations. Unique polarity keys and colors are used for each wiring configuration. (3 circuit=black, 2+2=blue, 3+1=green).

To Order, Specify:

- 1) Product number.
(No finish specification required.)

Description	Frame Width	Length	Number	Price
3-Circuit	18"(457mm)	36"(914mm)	VZEJ-0018-3	\$309.46
4-Circuit, 2+2	18"(457mm)	36"(914mm)	VZEJ-0018-2	318.41
4-Circuit, 3+1	18"(457mm)	36"(914mm)	VZEJ-0018-4	318.41
3-Circuit	24"(610mm)	42"(1067mm)	VZEJ-0024-3	\$ 415.16
4-Circuit, 2+2	24"(610mm)	42"(1067mm)	VZEJ-0024-2	424.11
4-Circuit, 3+1	24"(610mm)	42"(1067mm)	VZEJ-0024-4	424.11

Electrical Components

Power Connector — Below WS

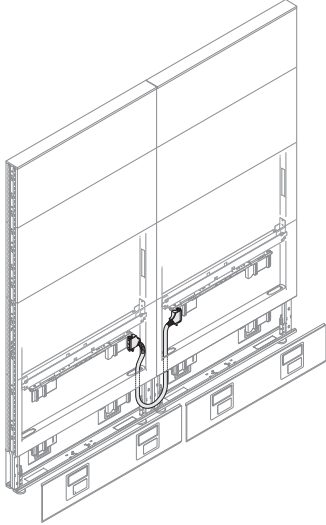

VZEJ-0038-3
VZEJ-0038-2
VZEJ-0038-4



Class BC

Features

- Includes flexible conduit power connector with integral safety latches.
- Spans power at below worksurface height for adjacent panels powered at that level and when frames do not have a cutout.

Specification Tips

- **For use with 120 volt 60 hertz power sources only.**
- For use with below worksurface power kits.
- Connector spans to adjacent frame in straight, 120° or 90° corner configuration.
- Not for use with tiles to the floor.
- Do not mix components from different wiring configurations. Unique polarity keys and colors are used for each wiring configuration. (3 circuit=black, 2+2=blue, 3+1=green).

To Order, Specify:

- 1) Product number.
(No finish specification required.)

Description	Length	Number	Price
3-Circuit	38"(965mm)	VZEJ-0038-3	\$ 415.16
4-Circuit, 2+2	38"(965mm)	VZEJ-0038-2	424.11
4-Circuit, 3+1	38"(965mm)	VZEJ-0038-4	424.11

Electrical Components

TripLEX Receptacle — 15 Amp

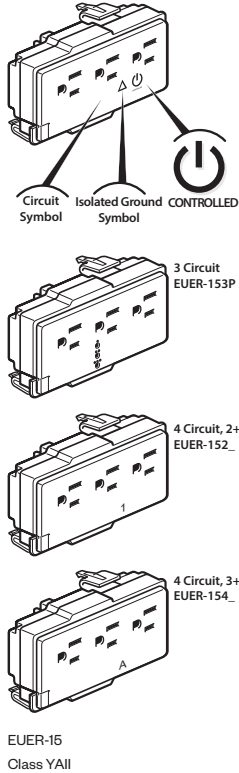

Features

- Includes box of six receptacles, each receptacle has three 15 Amp outlets (NEMA 5-15R configuration).
- For use with frames equipped with power components.
- Receptacles are ground type specific.

Specification Tips

- **For use with 120 volt 60 hertz power sources only.**
- For power access at any location within the panels with appropriate base raceway covers or technology pad.
- Isolated ground receptacle not for use with single circuit base feed module.
- TripLEXes for 3-Circuit are field programmable.
- TripLEXes for 4-Circuit have fixed circuit access and are not field programmable. Specify appropriate number of receptacles for each circuit.
- Do not mix components from different wiring configurations. Unique polarity keys and colors are used for each wiring configuration. (3 circuit=black, 2+2=blue, 3+1=green).
- **Controlled receptacles are marked with a permanent symbol and the word CONTROLLED to comply with various energy code requirements including ASHRAE 90.1 and California Building Code Title 24 part 6.**
- **Circuit assignment and receptacle placement should be coordinated with a local electrician. Local electrician is responsible for circuit loading and code compliance.**
- **Consult with local authority having jurisdiction (AHJ) for requirements regarding controlled receptacles before placing orders and installation.**

Receptacle Indicator

Circuit Symbol	Circuit 1	Circuit 2	Circuit 3	Circuit 4
3 Circuit	0	00	000	NA
4 Circuit 2+2	1	2	3	4
4 Circuit 3+1	A	B	C	D

To Order, Specify:

- 1) Product number.
- 2) Trim color.

TR-R	Beige
TR-TY	Cement
TR-AK	Chalk
TR-K	Charcoal
TR-J	Graphite
TR-G	Gray Tone
TR-NG	Orange*
TR-TW	Plaster
TR-AA	Putty
TR-E	Smoke

* Orange available on Isolated ground only.

Description	Circuit Access	Ground Type	Receptacle without Controlled Symbol	Price	Receptacle with Controlled Symbol	Price
3-Circuit						
	Circuit 1-3	Common	EUER-153P-GSOS	\$ 177.24	EUER-153P-GCOS	\$ 181.68
	Circuit 1-3	Isolated	EUER-153P-ISOS	188.08	EUER-153P-ICOS	192.79
4-Circuit, 2+2						
	Circuit 1	Common	EUER-1521-GSOS	\$ 253.21	EUER-1521-GCOS	\$259.54
	Circuit 2		EUER-1522-GSOS	253.21	EUER-1522-GCOS	259.54
	Circuit 3		EUER-1523-GSOS	253.21	EUER-1523-GCOS	259.54
	Circuit 4		EUER-1524-GSOS	253.21	EUER-1524-GCOS	259.54
	Circuit 1	Isolated	EUER-1521-ISOS	\$264.05	EUER-1521-ICOS	\$270.66
	Circuit 2		EUER-1522-ISOS	264.05	EUER-1522-ICOS	270.66
	Circuit 3		EUER-1523-ISOS	264.05	EUER-1523-ICOS	270.66
	Circuit 4		EUER-1524-ISOS	264.05	EUER-1524-ICOS	270.66
4-Circuit, 3+1						
	Circuit 1	Common	EUER-1541-GSOS	\$ 253.21	EUER-1541-GCOS	\$259.54
	Circuit 2		EUER-1542-GSOS	253.21	EUER-1542-GCOS	259.54
	Circuit 3		EUER-1543-GSOS	253.21	EUER-1543-GCOS	259.54
	Circuit 4		EUER-1544-GSOS	253.21	EUER-1544-GCOS	259.54
	Circuit 1	Isolated	EUER-1541-ISOS	\$264.05	EUER-1541-ICOS	\$270.66
	Circuit 2		EUER-1542-ISOS	264.05	EUER-1542-ICOS	270.66
	Circuit 3		EUER-1543-ISOS	264.05	EUER-1543-ICOS	270.66
	Circuit 4		EUER-1544-ISOS	264.05	EUER-1544-ICOS	270.66

Electrical Components

Triplic Receptacle — 20 Amp

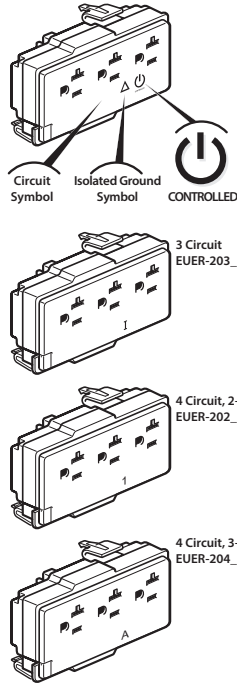

EUE-20
Class YAll

Features

- Includes box of six receptacles, each receptacle has three 20 Amp outlets (NEMA 5-20R configuration).
- For use with panels equipped with power components.
- **Receptacles are circuit and ground type specific.**

Specification Tips

- **For use with 120 volt 60 hertz power sources only.**
- Receptacles have fixed circuit access and are not field programmable. Specify appropriate number of receptacles for each circuit.
- For power access at any location within the frames with appropriate base raceway covers or technology pad.
- Isolated ground receptacle not for use with single circuit base feed module.
- Do not mix components from different wiring configurations. Unique polarity keys and colors are used for each wiring configuration. (3 circuit=black, 2+2=blue, 3+1=green).
- **Controlled receptacles are marked with a permanent symbol and the word CONTROLLED to comply with various energy code requirements including ASHRAE 90.1 and California Building Code Title 24 part 6.**
- **Circuit assignment and receptacle placement should be coordinated with a local electrician. Local electrician is responsible for circuit loading and code compliance.**
- **Consult with local authority having jurisdiction (AHJ) for requirements regarding controlled receptacles before placing orders and installation.**

Receptacle Indicator

Circuit Symbol	Circuit 1	Circuit 2	Circuit 3	Circuit 4
3 Circuit	I	II	III	NA
4 Circuit 2+2	1	2	3	4
4 Circuit 3+1	A	B	C	D

To Order, Specify:

- 1) Product number.
- 2) Trim color.

TR-R	Beige
TR-TY	Cement
TR-AK	Chalk
TR-K	Charcoal
TR-J	Graphite
TR-G	Gray Tone
TR-NG	Orange*
TR-TW	Plaster
TR-AA	Putty
TR-E	Smoke

* Orange available on Isolated ground only.

Description	Circuit Access	Ground Type	Receptacle without Controlled Symbol	Price	Receptacle with Controlled Symbol	Price
3-Circuit						
	Circuit 1	Common	EUE-2031-GSOS	\$524.52	EUE-2031-GCOS	\$ 537.61
	Circuit 2		EUE-2032-GSOS	524.52	EUE-2032-GCOS	537.61
	Circuit 3		EUE-2033-GSOS	524.52	EUE-2033-GCOS	537.61
	Circuit 1	Isolated	EUE-2031-ISOS	\$535.35	EUE-2031-ICOS	\$548.72
	Circuit 2		EUE-2032-ISOS	535.35	EUE-2032-ICOS	548.72
	Circuit 3		EUE-2033-ISOS	535.35	EUE-2033-ICOS	548.72
4-Circuit, 2+2						
	Circuit 1	Common	EUE-2021-GSOS	\$524.52	EUE-2021-GCOS	\$ 537.61
	Circuit 2		EUE-2022-GSOS	524.52	EUE-2022-GCOS	537.61
	Circuit 3		EUE-2023-GSOS	524.52	EUE-2023-GCOS	537.61
	Circuit 4		EUE-2024-GSOS	524.52	EUE-2024-GCOS	537.61
	Circuit 1	Isolated	EUE-2021-ISOS	\$535.35	EUE-2021-ICOS	\$548.72
	Circuit 2		EUE-2022-ISOS	535.35	EUE-2022-ICOS	548.72
	Circuit 3		EUE-2023-ISOS	535.35	EUE-2023-ICOS	548.72
	Circuit 4		EUE-2024-ISOS	535.35	EUE-2024-ICOS	548.72
4-Circuit, 3+1						
	Circuit 1	Common	EUE-2041-GSOS	\$524.52	EUE-2041-GCOS	\$ 537.61
	Circuit 2		EUE-2042-GSOS	524.52	EUE-2042-GCOS	537.61
	Circuit 3		EUE-2043-GSOS	524.52	EUE-2043-GCOS	537.61
	Circuit 4		EUE-2044-GSOS	524.52	EUE-2044-GCOS	537.61
	Circuit 1	Isolated	EUE-2041-ISOS	\$535.35	EUE-2041-ICOS	\$548.72
	Circuit 2		EUE-2042-ISOS	535.35	EUE-2042-ICOS	548.72
	Circuit 3		EUE-2043-ISOS	535.35	EUE-2043-ICOS	548.72
	Circuit 4		EUE-2044-ISOS	535.35	EUE-2044-ICOS	548.72

Electrical Components

Information Plate Communication Port Kits

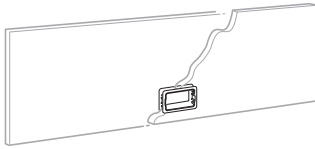

NECK-1

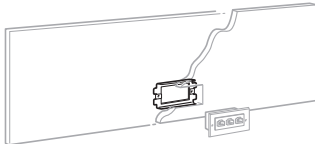

NECK-2
Class CA

Features

- Provides communications port on fabric tile.
- Two types are available:
 - NECK-1 provides front and back mounting frames.
 - NECK-2 provides a backer plate.

Specification Tips

- Requires a field-cut hole 2.5”(64mm)H x 3.625”(92mm)W.
- Field-cut hole must be a minimum of 3”(76mm) from the perimeter of the tile to maintain structural stability.
- Communications information plates are not provided by Haworth and must be purchased separately.
- Verify clearance with any power components that may be mounted behind tile.
- For use with fabric tiles only.

To Order, Specify:

- 1) Product number.
- 2) Trim color for Information Plate.

- TR-R Beige
- TR-AK Chalk
- TR-K Charcoal
- TR-J Graphite
- TR-G Gray Tone
- TR-TW Plaster
- TR-AA Putty
- TR-E Smoke

Height	Width	Description	Number	Price
2.75”(70mm)	4”(102mm)	For Information Plate	NECK-1	\$ 97.28
2.125”(54mm)	4.125”(105mm)	For Standard Outlet	NECK-2	135.00

Receptacle Blank Cover

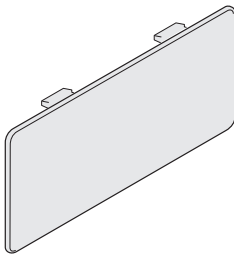

VZAR-0000
Class BC

Features

- Includes one cover.
- Used to cover unused electrical openings at all receptacle locations.

To Order, Specify:

- 1) Product number.
- 2) Trim color.

- TR-R Beige
- TR-AK Chalk
- TR-K Charcoal
- TR-J Graphite
- TR-G Gray Tone
- TR-TW Plaster
- TR-AA Putty
- TR-E Smoke

Height	Width	Number	Price
2.25”(57mm)	5”(127mm)	VZAR-0000	\$ 8.92

Power and Communication Bezel — Full Panel and Connections

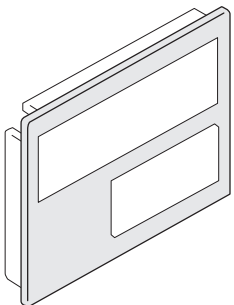

VZAP-0000-T
Class BC

Feature

- Power and Communication Bezel includes one bezel and mounting hardware for use with fabric tiles only.

Specification Tips

- Specify receptacles to match bezel.
- Power and communication bezels can be used with wood, laminate, slat or fabric tiles.
- For fabric tiles prior to March 2009, refer to eParts for replacement bezels.
- Not for use with Beam.

To Order, Specify:

- 1) Product number.
- 2) Trim color.

- TR-R Beige
- TR-AK Chalk
- TR-K Charcoal
- TR-J Graphite
- TR-G Gray Tone
- TR-TW Plaster
- TR-AA Putty
- TR-E Smoke

Number	Price
VZAP-0000-T	\$ 14.28

Electrical Components

Data Blank Cover — Full Panel and Connections

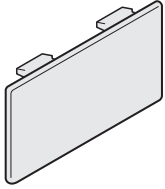

VZAD-0000-R
Class BC

Features

- Includes one Modular Furniture Telecommunications blank cover.
- Used to cover unused 1.38"(35mm) x 2.71"(69mm) data openings in tile bezels and base raceway cover.
- Not for use with Beam

To Order, Specify:

- 1) Product number.
 - 2) Trim color.
- TR-R Beige
TR-AK Chalk
TR-K Charcoal
TR-J Graphite
TR-G Gray Tone
TR-TW Plaster
TR-AA Putty
TR-E Smoke

Height	Width	Number	Price
1.625"(41mm)	3.125"(79mm)	VZAD-0000-R	\$ 5.36

Power and Communication Bezel — Beam

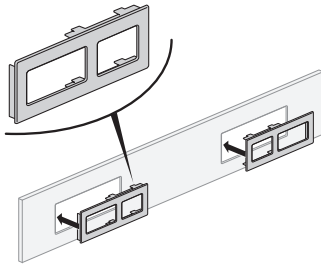

VZAP-0000-J
Class BC

Feature

- Includes one bezel and mounting hardware.

Specification Tips

- Specify receptacles to match bezel.
- Use a pre-cut tile as a template for field porting of fabric tiles only.
- Can be used as a replacement on all Beam Technology tiles.
- **Must order communication Data Bracket(s)(VZAJ-0000) if using Data Faceplates.**

To Order, Specify:

- 1) Product number.
 - 2) Trim color.
- TR-R Beige
TR-AK Chalk
TR-K Charcoal
TR-J Graphite
TR-G Gray Tone
TR-TW Plaster
TR-AA Putty
TR-E Smoke

Number	Price
VZAP-0000-J	\$ 14.28

Communication Data Bracket — Beam

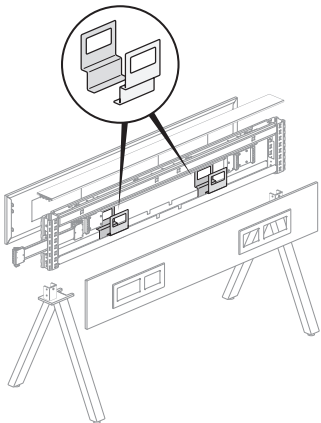

VZAJ-0000
Class BC

Feature

- Includes one black single-sided communication bracket and attachment hardware.

Specification Tips

- Communication Data Bracket is required for the attachment of furniture data plates.
- Only for use with Beam.
- Not for use on 24"(610mm)W tiles.
- 30"(762mm)W tiles can accommodate only one bezel.
- Bezel communication port opening accepts furniture data plates.

To Order, Specify:

- 1) Product number.
- (No finish specification required.)

Number	Price
VZAJ-0000	\$ 92.55

Electrical Components

Data Blank Cover — Beam

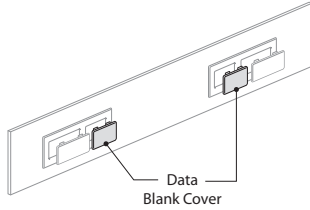

VZAD-0000-B
Class BC

Features

- Includes one blank cover.
- Used to cover unused 3.25"(83mm) x 2"(51mm) data openings in Beam bezel (VZAP-0000-J) only.
- Mounts directly to the Beam Power and Communication Bezel.

To Order, Specify:

- 1) Product number.
- 2) Trim color.
 - TR-R Beige
 - TR-AK Chalk
 - TR-K Charcoal
 - TR-J Graphite
 - TR-G Gray Tone
 - TR-TW Plaster
 - TR-AA Putty
 - TR-E Smoke

Height	Width	Number	Price
1.625"(41mm)	3.125"(79mm)	VZAD-0000-B	\$ 8.92

Frame Rail Grommet

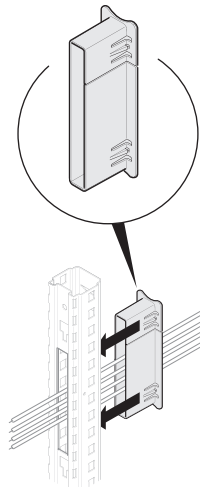

VZEG-0601-V
Class BC

Features

- Includes 12 grommets.
- Additional protection for cables threaded through frame.

To Order, Specify:

- 1) Product number.
(No color specification required.)

Specification Tips

- For use in frames 26"(660mm) to 74"(1880mm)H.
- Inserts into the utility cutouts in the vertical panel frame tubes, only.
- Not for use in cutouts in horizontal panel frame tubes.
- Field installed; inserts into utility cutouts.

Number	Price
VZEG-0601-V	\$234.26

Tile Grommet Kit

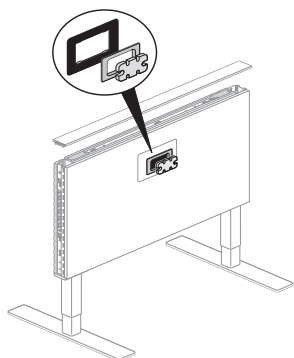

VZAG
Class BC – GSA Open Market

Features

- Includes one black grommet, black filler plate and mounting hardware.
- For use with any tile material.
- Dimensions:
 - Outside: 2.75"(51mm)H x 4.75"(102mm)W
 - Inside: 1.875"(48mm)H x 3.875"(98mm)W
- Available in black only.

To Order, Specify:

- 1) Product number.
(No finish specification required.)

Specification Tips

- Requires field cutting of tile.
- Can be used to pass Jumper, conduit Power Tap or power cords through a tile.
- Cord applications should be reviewed by local authorities prior to ordering due to varying local codes.
- Grommet cannot be positioned over frame, power distribution assembly or Jumper.

Height	Width	Number	Price
2.75"(70mm)	4.75"(121mm)	VZAG-0305	\$ 93.30

Electrical Components

Frame Mounted Power Tap Bracket — Concealed

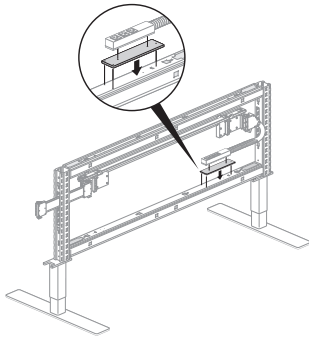

VZAB
Class BC

Features

- Includes one power tap mounting bracket and mounting hardware.
- For use with conduit vertical Power Tap and Tile Grommet Kit.

Specification Tips

- Used to mount 30"(762mm) vertical conduit Power Tap to interior of Full Panel or Connections Frame; specified separately.
- Not for use with plugs that are more than 2"(51mm)W.
- Not for use with corded Enhanced Power Module, Flush Mount, Flip Top, workware Interface units with 4 or more power ports.
- 24"(610mm) and 30"(762mm) frames accommodate one power tap bracket. Frames over 30"(762mm) accommodate two power tap brackets.
- Application should be reviewed by local authorities prior to ordering due to varying local codes.

To Order, Specify:

- 1) Product number.
(No finish specification required.)

Height	Width	Number	Price
1.5"(38mm)	7.5"(191mm)	VZAB-0208	\$ 124.42

Frame Mounted Data Plate Bracket — Concealed

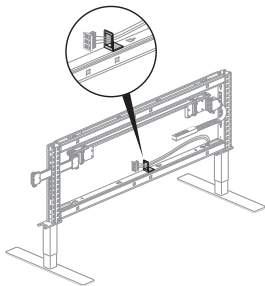

VZAB-0204
Class BC

Features

- Includes one data plate mounting bracket and mounting hardware.
- For use with data plates that fit 2.71"(69mm) x 1.38"(35mm) opening.

Specification Tips

- Used to mount data plate to interior of Full Panel or Connections frame.
- 24"(610mm) and 30"(762mm) frames accommodate one Data Plate Bracket. Frames over 30"(762mm) accommodate two Data Plate Brackets.
- Application should be reviewed by local authorities prior to ordering due to varying local codes.

To Order, Specify:

- 1) Product number.
(No finish specification required.)

Height	Width	Number	Price
4"(102mm)	1.5"(38mm)	VZAB-0204	\$ 97.23

Adaptor Plate, Single Gang

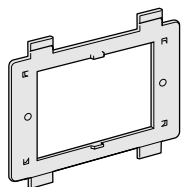

VZAP-0000-G
Class BC

Features

- Single Gang Adaptor Plate includes one communication adaptor plate.
- Single Gang Plate provides backer plate to mount standard single gang communication outlet plate (NEMA WD-6 configuration) on a raceway cover with single gang option.
- Provides 2.25"(57mm)H x 3.75"(95mm)W opening.
- Black finish only.

Specification Tips

- Single gang porting of fabric tiles is not recommended.
- Single gang raceway cover 30"(762mm) or wider may be ordered separately.

To Order, Specify:

- 1) Product number.
(No finish specification required.)

Description	Number	Price
Adaptor Plate, Single Gang	VZAP-0000-G	\$ 56.06

Electrical Components

Cable Management Bracket

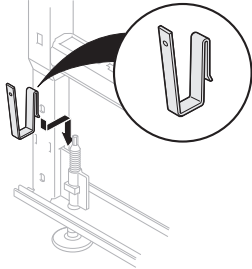

VZBC-0000
Class BC

Features

- Includes 8 cable management brackets.
- Manages communication cables horizontally in the base raceway.
- Works within base raceways only.
- Not for use with tiles to the floor.

To Order, Specify:

- 1) Product number.
(No finish specification required.)

Height	Depth	Width	Number	Price
3.8"(97mm)	1.5"(38mm)	0.4"(10mm)	VZBC-0000	\$ 58.82

Compose Task Light Cord Manager



VZAW-0000-V
Class BC

Features

- Includes package of 10.
- Vertical wire manager conceals task light cord.
- Attaches into Compose panel frame slots.
- Black finish only.

To Order, Specify:

- 1) Product number.
(No finish specification required.)

Description	Length	Number	Price
Wire Manager, Vertical	17"(432mm)	VZAW-0000-V	\$258.50

Compose Connections Cable Chain

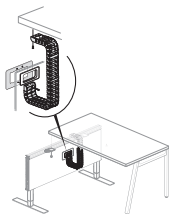

EUAW-4000-V
Class YA

Features

- Includes grommet, grommet backer plate, cable chain, bracket to mount to adjacent table and mounting hardware.
- Color black only.
- Mounts to tile and underside of adjacent worksurface to contain power cords and data cables that are routed from inside Compose Connections panel to an adjacent worksurface.
- Holds up to three power cords and two data cables.

To Order, Specify:

- 1) Product number.
(No finish specification required.)

Height	Width	Actual Length	Installed Length	Number	Price
0.75"(19mm)	2.25"(57mm)	40"(1016mm)	36"(914mm)	EUAW-4000-V	\$ 407.19

Power Break Marker

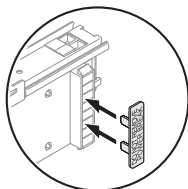

NEP-1
Class BC

Features

- Includes box of fifty plastic markers.
- Use one marker at each power distribution assembly to close the flex connector site wherever an improper electrical connection may occur.
- Features following message: "Do not remove – Power Break."

To Order, Specify:

- 1) Product number.
(No finish specification required.)

Number	Price
NEP-1	\$ 254.19

Power Distribution for Hardwire Applications

Hardwire power applications are designed to address non-modular power planning solutions.

1. Power distribution from building-to-panel.
2. Vertical power distribution.
3. Horizontal power distribution.

Infeeds

Applications

1	Base Feed	48" (1219mm) or as required
2	Top Feed	Ceiling Height (H) + 18" (457mm)

Panel Applications

Panel Applications

3	Between two junction boxes on one panel	Panel Width (W) – 21" (533mm)
4	Between junction boxes if one per panel	Panel Width (W) – 5" (127mm)
5	Across panel connection	12" (305mm)
6	Across 3- or 4-Way connection	16" (406mm)
7	Base to Beltline	40" (1016mm)
8	Base to under worksurface	24" (610mm)
9	Base to standing height	56" (1422mm)

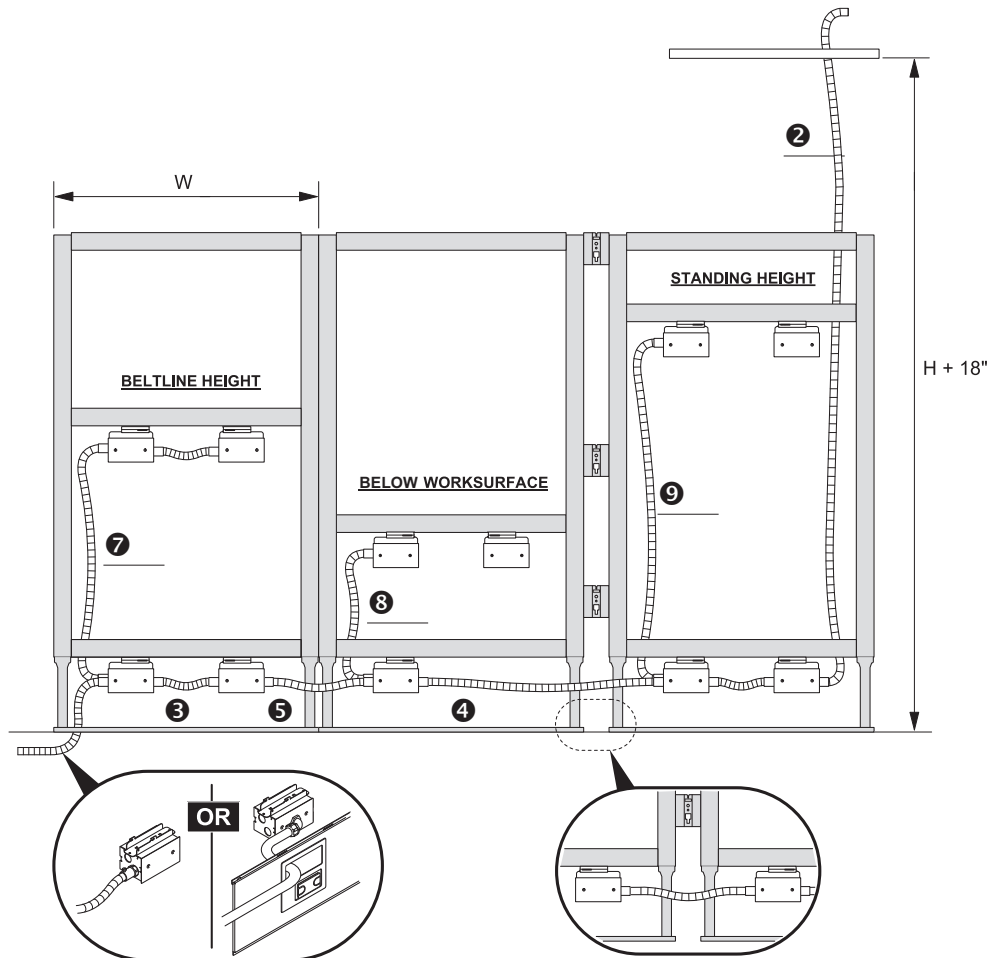

Electrical Components

Hardwire

Base Feed Hardwire Plate

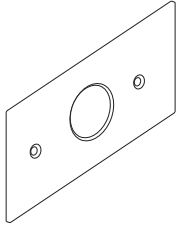

VZEB-0000-C



Class BC

Feature

- Includes one junction box cover plate with 0.5”(13mm) hole.

Specification Tips

- For floor, column, or wall hardwire connections to fixed power installations.
- Conduit and fillings are field supplied.

To Order, Specify:

1) Product number.

2) Trim color.

- TR-R Beige
- TR-AK Chalk
- TR-K Charcoal
- TR-J Graphite
- TR-G Gray Tone
- TR-TW Plaster
- TR-AA Putty
- TR-E Smoke

Description	Number	Price
Hardwire (Chicago)	VZEB-0000-C	\$ 96.48

Top Feed Module, Hardwired (Pole Only)

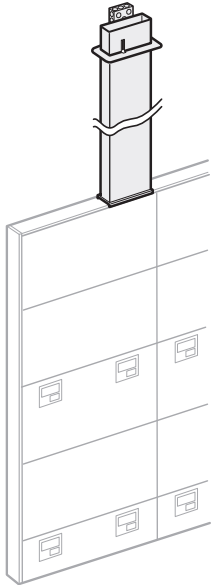

VZET-NT
VZET-NW



Class BC

Features

- Includes one electrical box, ceiling bezel plate, pole and hardware.
- For connection to the electrical source located in space above a drop ceiling.
- Pole longer than 120”(3048mm) will consist of two sections.
- Removable cover on poles provides access to pathway.
- Routes power to base raceway, below worksurface, beltline or standing height.

Specification Tips

- For routing and cabling capacities, see Specification Guide.
- Not for use with:
 - 18”(457mm)W frames.
 - Glass panels.
 - Glass stack frames.
- Mounts on top of the frame at either end of the frame.
- Requires field cut of top cap/work rail.
- Application may require approval of local authority having jurisdiction (AHJ); ensure compliance before placing orders and installation.

To Order, Specify:

1) Product number, including:

1 Trim Option

- A** Aluminum or Wood
- H** Steel

2) Trim color.

Panel Height	Pole Length	Number	Trim	
			A	B
10' Ceiling Height				
26”(660mm)	120”(3048mm)	VZET-2600-NT	\$942.39	\$ 1137.00
28”(711mm)	120”(3048mm)	VZET-2800-NTG	940.53	1133.70
34”(864mm)-58”(1473mm)	95”(2413mm)	VZET-3400-NT	929.37	1113.90
66”(1676mm)-90”(2286mm)	66”(1676mm)	VZET-6600-NT	867.99	1005.00
12' Ceiling Height				
26”(660mm)	148”(3759mm)	VZET-2600-NW	\$987.03	\$ 1216.20
28”(711mm)	148”(3759mm)	VZET-2800-NWG	983.31	1209.60
34”(864mm)-50”(1270mm)	120”(3048mm)	VZET-3400-NW	972.15	1189.80
58”(1473mm)-90”(2286mm)	95”(2413mm)	VZET-6600-NW	912.63	1084.20

Electrical Components

Hardwire

End-of-Run Top Feed Module, Hardwired (Pole Only) — Connections and Below WS Power

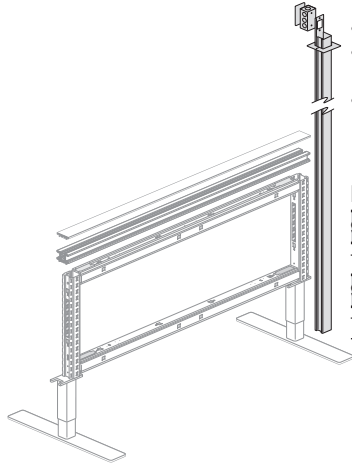

VZET-NTEC
VZET-NWEC



Class BC

Features

- Includes one electrical box, ceiling bezel plate, pole and hardware.
- For connection to the electrical source located in space above a drop ceiling.
- Removable cover on poles provides access to pathway.
- Pole longer than 120"(3048mm) will consist of two sections.

Specification Tips

- For routing and cabling capacities, see Specification Guide.
- Mounts to the end of the frame replacing end-of-run trim.
- Specification of end-of-run trim not necessary when using End-of-Run Top Feed.
- Not for use with 2-way, 3-way or 4-way applications.
- Application may require approval of local authority having jurisdiction (AHJ); ensure compliance before placing orders and installation.
- For use with Connections or below worksurface power. Provides below worksurface power access only.

To Order, Specify:

- 1) Product number.
- 2) Trim color.

Pole Length	Number	Trim	
		A	B
9.5' Ceiling Height			
120"(3048mm)	VZET-2600-NTEC	\$1318.08	\$1512.69
9.5'-12' Ceiling Height			
148"(3759mm)	VZET-2600-NWEC	\$1362.72	\$1591.89

End-of-Run Top Feed Module, Hardwired (Pole Only) — Beam Only

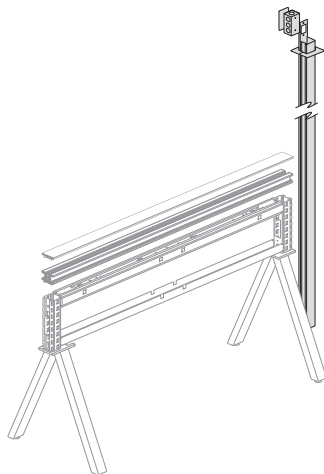

VZET-NTEJ
VZET-NWEJ



Class BC

Features

- Includes one electrical box, ceiling bezel plate, pole and hardware.
- For connection to the electrical source located in space above a drop ceiling.
- Removable cover on poles provides access to pathway.
- Pole longer than 120"(3048mm) will consist of two sections.

Specification Tips

- For routing and cabling capacities, see Specification Guide.
- Mounts to the end of the frame replacing end-of-run trim.
- Specification of end-of-run trim not necessary when using End-of-Run Top Feed.
- Not for use with 2-way, 3-way or 4-way applications.
- Application may require approval of local authority having jurisdiction (AHJ); ensure compliance before placing orders and installation.

To Order, Specify:

- 1) Product number.
- 2) Trim color.

Pole Length	Number	Trim	
		A	B
9.5' Ceiling Height			
120"(3048mm)	VZET-2600-NTEJ	\$1318.08	\$1512.69
9.5'-12' Ceiling Height			
148"(3759mm)	VZET-2600-NWEJ	\$1362.72	\$1591.89

Electrical Components

Hardwire

Raceway Retrofit Kits

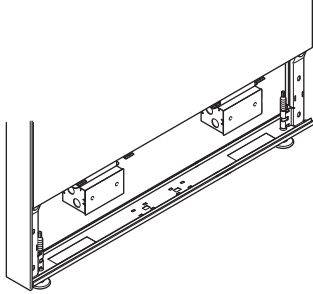

VZEK-C



Class BC

Features

- Hardwired power option kits includes two junction boxes, four blank plates and optional base covers. (Conduit and wiring field supplied)
- Converts non-powered frames to powered frames.

Specification Tips

- 8"(203mm) tiles cannot be used in place of base raceway cover.
- Not for use with tile to floor applications.
- 24"(610mm) raceway covers provide only one opening for power and data access on left side.
- **For single gang option, frame width must be 30"(762mm) or greater.**
- Order single gang adaptor plate separately (VZAP-000-G).
- Refer to Specification Guide for Planning with Utilities.
- **Receptacle and data blank covers must be specified separately.**

To Order, Specify:

1) Product number, including:

1 Cover Option Side One

(see chart below for upcharges)

- N** Tile to Floor
- H** Cover with knockouts
- B** Cover without knockouts
- G** Single Gang

2 Cover Option Side Two

(see chart below for upcharges)

- N** Tile to Floor
- H** Cover with knockouts
- B** Cover without knockouts
- G** Single Gang

2) Trim color for cover side 1.

3) Trim color for cover side 2.

Cover Option	Side One		Side Two	
	Trim A	Trim B	Trim A	Trim B
H	\$135.14	\$145.20	\$135.14	\$145.20
B	135.14	145.20	135.14	145.20
G	159.25	166.61	159.25	166.61

Panel Width

Number 1 2

Trim

A B

Panel Width	Number 1 2	Trim A	Trim B
24"(610mm)	VZEK-OR24-C ■ ■	\$368.34	\$ 381.26
30"(762mm)	VZEK-OR30-C ■ ■	386.36	401.08
36"(914mm)	VZEK-OR36-C ■ ■	404.38	420.90
42"(1067mm)	VZEK-OR42-C ■ ■	422.40	440.72
48"(1219mm)	VZEK-OR48-C ■ ■	440.42	460.54
54"(1372mm)	VZEK-OR54-C ■ ■	458.44	480.36
60"(1524mm)	VZEK-OR60-C ■ ■	476.46	500.18
72"(1829mm)	VZEK-OR72-C ■ ■	1142.40	1169.72

Electrical Components

Hardwire

Raceway Covers

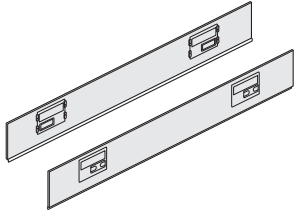

VZEK-N



Class BC

Features

- Includes two single covers unless tile to floor option is specified which includes one cover.

Specification Tips

- For single gang option, panel width must be 30"(762mm) or greater. Order adaptor plate separately (VZAP-0000-G).
- 8"(203mm) tiles cannot be used in place of base raceway cover.
- 18"(457mm) raceway cover has no knockouts.
- 24"(610mm) raceway covers provide only one knockout located on left side.
- Refer to Specification Guide for Planning with Utilities.
- **Receptacle and data blank covers must be specified separately.**

To Order, Specify:

1) Product number, including:

1 Cover Option Side One

(see chart below for upcharges)

- N** Tile to Floor
- H** Cover with knockouts
- B** Cover without knockouts
- G** Single gang

2 Cover Option Side Two

(see chart below for upcharges)

- H** Cover with knockouts
- B** Cover without knockouts
- G** Single gang

2) Trim color for cover side 1.

3) Trim color for cover side 2.

Cover Option	Side One		Side Two	
	Trim A	Trim B	Trim A	Trim B
H	\$135.14	\$148.06	\$135.14	\$148.06
B	135.14	148.06	135.14	148.06
G	24.11	38.33	24.11	38.33

Panel Width	Number 12	Trim	
		A	B
18"(457mm)	VZEK-OR18-NBB	\$296.24	\$307.36
24"(610mm)	VZEK-OR24-N ■ ■	179.12	185.58
30"(762mm)	VZEK-OR30-N ■ ■	197.14	204.50
36"(914mm)	VZEK-OR36-N ■ ■	215.16	223.42
42"(1067mm)	VZEK-OR42-N ■ ■	233.18	242.34
48"(1219mm)	VZEK-OR48-N ■ ■	251.20	261.26
54"(1372mm)	VZEK-OR54-N ■ ■	269.22	280.18
60"(1524mm)	VZEK-OR60-N ■ ■	287.24	299.10
72"(1829mm)	VZEK-OR72-N ■ ■	408.81	422.47

Electrical Components

Hardwire

Hardwire Power Kit — Single Sided for 26”(660mm)H Below WS, Connections and 42”(1067mm)H Panels at the Beltline

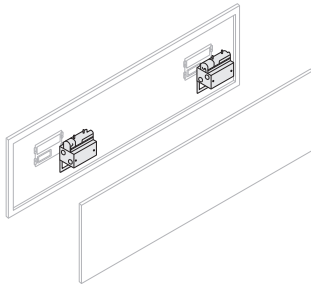

VZEK-2600-C1
Class BC

Features

- Includes two 24 cubic inch junction boxes, four blank plates and mounting hardware.
- Provides power access behind a tile with technology option or field ported fabric tile at below worksurface for 26”(660mm)H and Connections panels and at the beltline for 42”(1067mm)H panels.
- Conduit, fittings, wiring, and receptacles are field supplied.
- Conforms to city of Chicago code.

Specification Tips

- For use with Technology tile or field ported fabric tile on one side of frame only. Opposite side of frame can use any standard/non-technology tile.
- For use with non-technology hard surface tiles on back side.
- **Not for use with 8”(203mm)H tiles.**
- Power kit connects directly to the panel frame.
- Specify receptacle plates separately.

To Order, Specify:

- 1) Product number.
- 2) Trim color.
 - TR-R Beige
 - TR-AK Chalk
 - TR-K Charcoal
 - TR-J Graphite
 - TR-G Gray Tone
 - TR-TW Plaster
 - TR-AA Putty
 - TR-E Smoke

Panel / Frame Width	Number	Price
24”(610mm)-60”(1524mm)	VZEK-2600-C1	\$223.23

Hardwire Power Kit — Double Sided for 26”(660mm)H Below WS, Connections and 42”(1067mm)H Panels at the Beltline

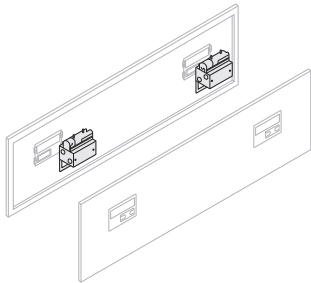

VZEK-2600-C2
Class BC

Features

- Includes two 29 cubic inch junction boxes, four blank plates and mounting hardware.
- Provides power access behind a tile with technology option or field ported fabric tile at below worksurface for 26”(660mm)H and Connections panels and at the beltline for 42”(1067mm)H panels.
- Conduit, fittings, wiring, and receptacles are field supplied.
- Conforms to city of Chicago code.

Specification Tips

- For use with matching width tile with technology option or field ported fabric tile.
- **Not for use with 8”(203mm)H tiles.**
- **Not for use with non-technology hard surface tiles on the back side.**
- Power kit connects directly to the panel frame.
- Specify receptacle plates separately.
- Match tile height on both sides of the frame.

To Order, Specify:

- 1) Product number.
- 2) Trim color.
 - TR-R Beige
 - TR-AK Chalk
 - TR-K Charcoal
 - TR-J Graphite
 - TR-G Gray Tone
 - TR-TW Plaster
 - TR-AA Putty
 - TR-E Smoke

Panel / Frame Width	Number	Price
24”(610mm)-60”(1524mm)	VZEK-2600-C2	\$223.23

Electrical Components

Hardwire

Hardwire Power Kit for Beltline, 50”(1270mm)H or Greater, Below WS and Standing Height

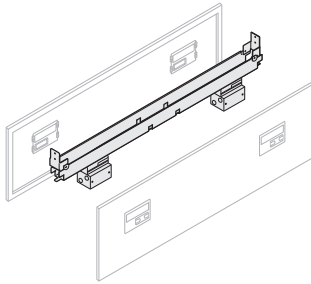

VZEK-C



Class BC

Features

- Includes two junction boxes, four blank plates, crossbar, brackets, aligner light block and mounting hardware.
Exception: 24”(610mm) hardwire kit includes one junction box, two blank plates, crossbar, brackets, aligner light block and mounting hardware.
- Provides power access behind a tile with technology option or field ported fabric tile at the beltline, below beltline or standing height.
- Conduit, fittings, wiring and receptacles are field supplied.
- Conforms to city of Chicago code.

Specification Tips

- For use with matching width tile with technology option or field ported fabric tile.
- **Not for use with 8”(203mm)H tiles.**
- **Not for use with non-technology hard surface tiles on the back side.**
- Not for use at standing height on 58”(1473mm)H panel.
- Specify receptacle plates separately.
- Match tile height on both sides of the frame.
- Refer to Specification Guide for planning with utilities.

To Order, Specify:

- 1) Product number.
 - 2) Trim color.
- | | |
|-------|-----------|
| TR-R | Beige |
| TR-AK | Chalk |
| TR-K | Charcoal |
| TR-J | Graphite |
| TR-G | Gray Tone |
| TR-TW | Plaster |
| TR-AA | Putty |
| TR-E | Smoke |

Panel / Frame Width	Number	Price
24”(610mm)	VZEK-OB24-C	\$ 325.17
30”(762mm)	VZEK-OB30-C	332.97
36”(914mm)	VZEK-OB36-C	340.77
42”(1067mm)	VZEK-OB42-C	348.57
48”(1219mm)	VZEK-OB48-C	356.37
54”(1372mm)	VZEK-OB54-C	364.17
60”(1524mm)	VZEK-OB60-C	371.97
72”(1829mm)	VZEK-OB72-C	613.10

Electrical Components

Hardwire

Hardwire Power Kit — Single Sided for Beam

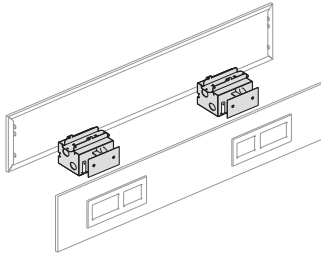

VZEK-0800-C1
Class BC

Features

- Single sided kit includes two 24 cubic inch junction boxes and four blank plates and mounting hardware.
- Conduit, fittings, wiring, and receptacles are field supplied.
- Conforms to city of Chicago code.

Specification Tips

- For use with Technology tile or field ported fabric tile on one side of frame only. Opposite side of frame can use any standard/non-technology tile.
- Provides technology access to one side of the frame.
- Specify receptacle plates separately.

To Order, Specify:

1) Product number.

2) Trim color.

- TR-R Beige
- TR-AK Chalk
- TR-K Charcoal
- TR-J Graphite
- TR-G Gray Tone
- TR-TW Plaster
- TR-AA Putty
- TR-E Smoke

Frame Width	Number	Price
24"(610mm)-72"(1829mm)	VZEK-0800-C1	\$223.23

Hardwire Power Kit — Double Sided for Beam

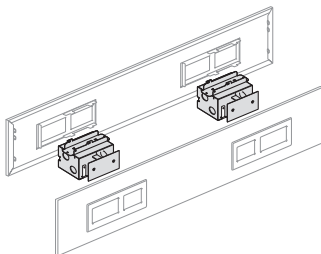

VZEK-0800-C2
Class BC

Features

- Double sided kit includes two 29 cubic inch junction boxes and four blank plates and mounting hardware.
- Conduit, fittings, wiring, and receptacles are field supplied.
- Conforms to city of Chicago code.

Specification Tips

- **Not for use with non-technology hard surface tile on the back side.**
- For use with Technology tile or field ported fabric tile.
- Provides technology access to both sides of the frame.
- Specify receptacle plates separately.

To Order, Specify:

1) Product number.

2) Trim color.

- TR-R Beige
- TR-AK Chalk
- TR-K Charcoal
- TR-J Graphite
- TR-G Gray Tone
- TR-TW Plaster
- TR-AA Putty
- TR-E Smoke

Frame Width	Number	Price
24"(610mm)-72"(1829mm)	VZEK-0800-C2	\$223.23

Electrical Components

Hardware

Receptacle Plate, Hardwired

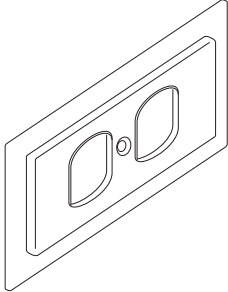

VZAP-0000-C
Class BC

Features

- Includes 4 receptacle plates.
- Mounts to hardwired junction box to allow mounting of a duplex receptacle. Hardwired Plate aligns receptacle with opening of bezel in Technology Tile or Base Raceway Cover.

To Order, Specify:

- 1) Product number.
- 2) Trim color.
 - TR-R Beige
 - TR-AK Chalk
 - TR-K Charcoal
 - TR-J Graphite
 - TR-G Gray Tone
 - TR-TW Plaster
 - TR-AA Putty
 - TR-E Smoke

Number

VZAP-0000-C

Price

\$ 53.49

Receptacle Plate, Hardwired

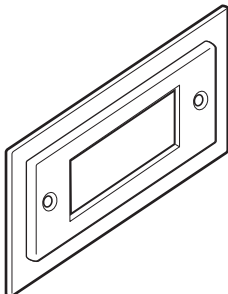

VZAP-0000-R
Class BC

Features

- Includes 4 receptacle plates.
- Mount to hardwired junction box to allow mounting of duplex receptacle. Hardwired Plate aligns receptacle with opening of bezel.

Specification Tip

- For use with Decora® receptacles with a rectangular face.

To Order, Specify:

- 1) Product number.
- 2) Trim color.
 - TR-R Beige
 - TR-AK Chalk
 - TR-K Charcoal
 - TR-J Graphite
 - TR-G Gray Tone
 - TR-TW Plaster
 - TR-AA Putty
 - TR-E Smoke

Number

VZAP-0000-R

Price

\$ 53.49

Gallery Panel

Gallery Panel to Full Panel

Catalog Logic

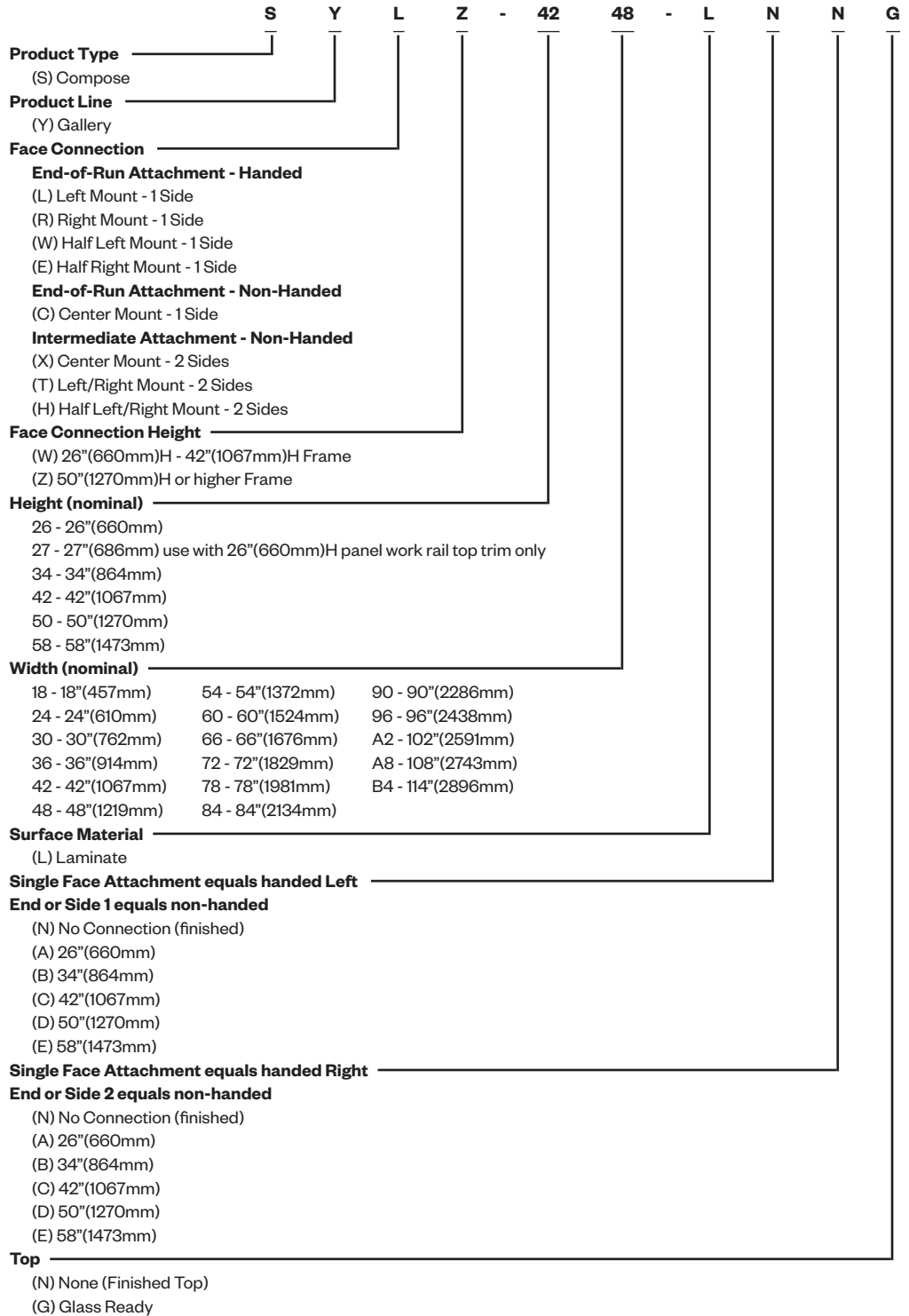

Gallery Panel

Gallery Panel to Beam

Catalog Logic

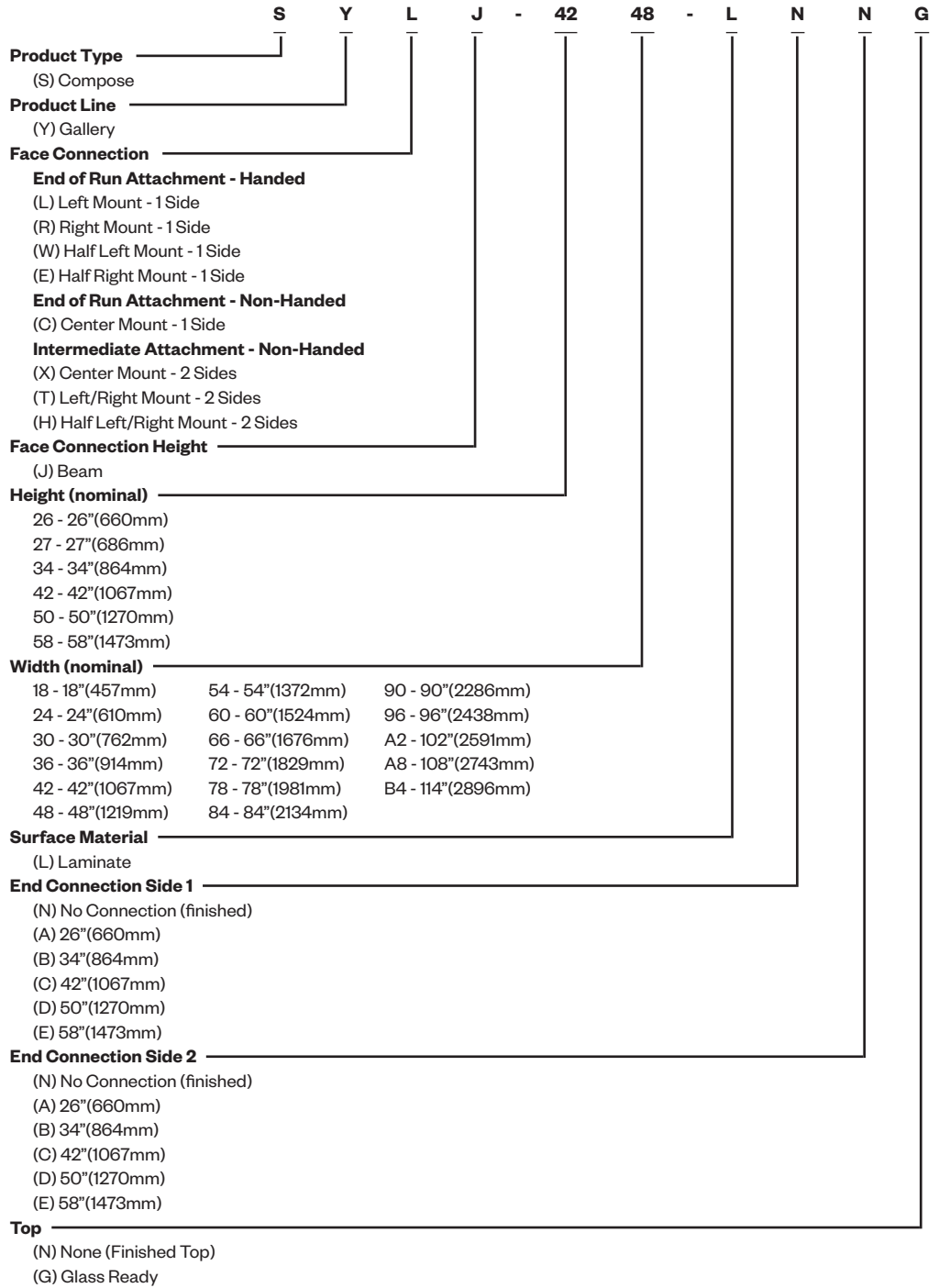

Gallery Panel

Gallery Panel to Gallery Panel

Catalog Logic

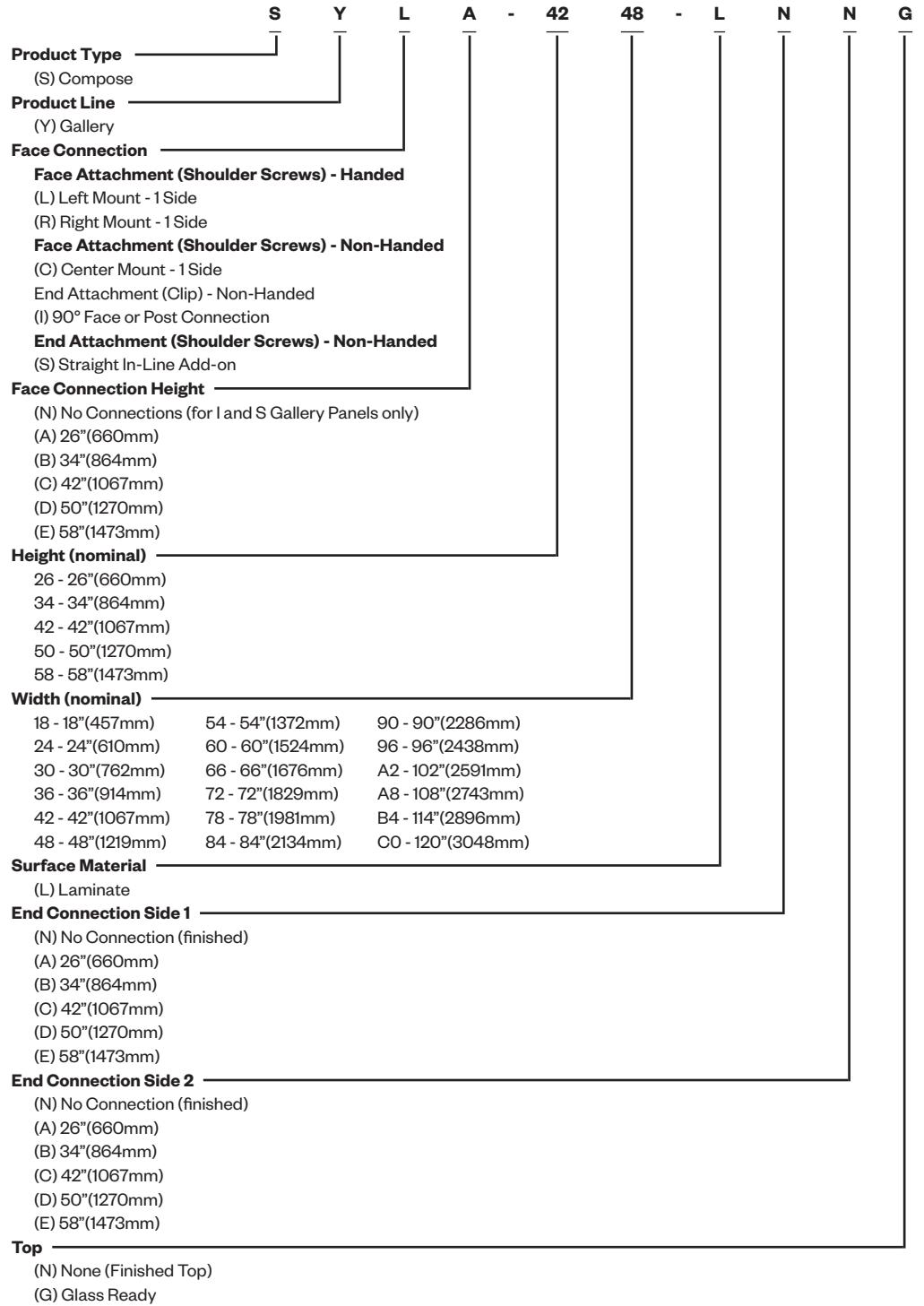

Gallery Panel to Compose Panel End-of-Run

L/R (Left or Right Mount)

(L) Left Hand Gallery Panel

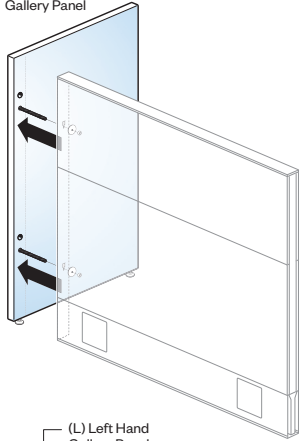

(L) Left Hand Gallery Panel

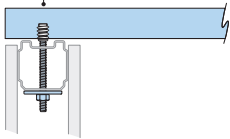

SYLW (Left Face)
SYLZ

(R) Right Hand Gallery Panel

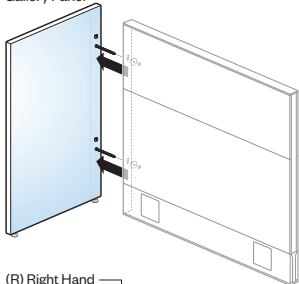

(R) Right Hand Gallery Panel

SYRW (Right Face)
SYRZ

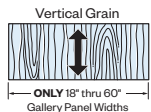
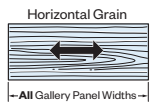

Class BC

Features

- Includes one pre-drilled, finished panel and attachment hardware.
- Gallery Panel is 1.18" (30mm) thick. Compose panel adds 3" (76mm) to width.
- High Pressure Laminate (HPL) panel has 1mm edgeband.
- Glides provide 1.5" (38mm) level adjustment.
- Panel and hardware are field installed.
- Rail for glass ready option standard in black.
- Handedness is determined by Face Connection.

Specification Tips

- For use at the end of a Compose Full Panel Frame. Takes the place of End-of-Run Trim. Separately specify Variable Height End-of-Run Trim if the Gallery Panel is shorter than the Panel application.
- Not for use with Compose Glass Panels.
- Gallery Panels and Compose Panel Frames can be the same height, lower or taller than each other. Full Panel Frame attachment heights on the Face of the Gallery Panel are available at 26" (660mm)H or 50" (1270mm)H:
 - If the Gallery Panel or Compose Panel Frame are 42" (1067mm)H or lower, select W (26" (660mm)H) for mounting height.
 - If the Gallery Panel and Compose Panel Frame are 50" (1270mm)H or higher select Z (50" (1270mm)H) for mounting height.
 - In conditions with Stack Frames, choose connection based on height of Full Panel Frame. **DO NOT MATCH HEIGHT OF STACK FRAME(S).**
- Gallery Panel has one Face connection only; select RH or LH.
- Gallery Panel End attachment is not allowed on the same hand as the Face attachment. Refer to the Specification Guide for Face and End mounting application guidelines.
- Specify No Glass option when using Glass Topper Holder Kit.
- "No Glass" Gallery Panels option cannot be retrofit to Glass Ready Option.
- Separately specify:
 - Insert Glass for Glass-Ready Gallery Panels
 - Glass Topper Holder Kit

To Order, Specify:

1) Product number, including:

1 Face Handed Connection

- L** Left Face
- R** Right Face

2 Face Connection Height

- W** 26" (660mm)H-42" (1067mm)H Frame
- Z** 50" (1270mm)H or higher Frame

3 Left End (Finished End or Connection End)

- N** No Connection (Finished End)
- A** 26" (660mm)H Connection (not available for Left-Hand orientation)
- B** 34" (864mm)H Connection (not available for Left-Hand orientation)
- C** 42" (1067mm)H Connection (not available for Left-Hand orientation)
- D** 50" (1270mm)H Connection (not available for Left-Hand orientation)
- E** 58" (1473mm)H Connection (not available for Left-Hand orientation)

4 Right End (Finished End or Connection End)

- N** No Connection (Finished End)
- A** 26" (660mm)H Connection (not available for Right-Hand orientation)
- B** 34" (864mm)H Connection (not available for Right-Hand orientation)
- C** 42" (1067mm)H Connection (not available for Right-Hand orientation)
- D** 50" (1270mm)H Connection (not available for Right-Hand orientation)
- E** 58" (1473mm)H Connection (not available for Right-Hand orientation)

5 Glass Options

- N** No Glass (Finished Top)
- G** Glass Ready

2) Laminate surface color.

3) Edgeband color.

Gallery Panel to Compose Panel End-of-Run

L/R (Left or Right Mount)

Nominal Height	Actual Width	Nominal Width	Number		No Glass HPL		Glass Ready HPL	
			①②	③④⑤	A	B	A	B
Gallery Panels 26"(660mm)H-42"(1067mm)H								
26"(660mm)	21"(533mm)	18"(457mm)	SY	W-2618-L	\$ 532.58	\$ 535.25	\$ 761.17	\$ 763.84
	27"(686mm)	24"(610mm)	SY	W-2624-L	565.22	573.23	848.31	856.32
	33"(838mm)	30"(762mm)	SY	W-2630-L	597.86	611.21	935.45	948.80
	39"(991mm)	36"(914mm)	SY	W-2636-L	785.94	804.63	1178.03	1196.72
	45"(1143mm)	42"(1067mm)	SY	W-2642-L	915.73	939.76	1362.32	1386.35
	51"(1295mm)	48"(1219mm)	SY	W-2648-L	948.37	977.74	1449.46	1478.83
	57"(1448mm)	54"(1372mm)	SY	W-2654-L	981.01	1015.72	1536.60	1571.31
	63"(1600mm)	60"(1524mm)	SY	W-2660-L	1013.65	1053.70	1623.74	1663.79
	69"(1753mm)	66"(1676mm)	SY	W-2666-L	1046.29	1091.68	1710.88	1756.27
	75"(1905mm)	72"(1829mm)	SY	W-2672-L	1078.93	1129.66	1798.02	1848.75
	81"(2057mm)	78"(1981mm)	SY	W-2678-L	1111.57	1167.64	1885.16	1941.23
	87"(2210mm)	84"(2134mm)	SY	W-2684-L	1144.21	1205.62	1972.30	2033.71
	93"(2362mm)	90"(2286mm)	SY	W-2690-L	1176.85	1243.60	2059.44	2126.19
	99"(2515mm)	96"(2438mm)	SY	W-2696-L	1209.49	1281.58	2146.58	2218.67
	105"(2667mm)	102"(2591mm)	SY	W-26A2-L	1242.13	1319.56	2233.72	2311.15
	111"(2819mm)	108"(2743mm)	SY	W-26A8-L	1274.77	1357.54	2320.86	2403.63
	117"(2972mm)	114"(2896mm)	SY	W-26B4-L	1307.41	1395.52	2408.00	2496.11
27"(686mm)	21"(533mm)	18"(457mm)	SY	W-2718-L	\$ 540.35	\$ 544.29	\$ 768.94	\$ 772.88
	27"(686mm)	24"(610mm)	SY	W-2724-L	572.99	582.27	856.08	865.36
	33"(838mm)	30"(762mm)	SY	W-2730-L	605.63	620.25	943.22	957.84
	39"(991mm)	36"(914mm)	SY	W-2736-L	793.71	813.67	1185.80	1205.76
	45"(1143mm)	42"(1067mm)	SY	W-2742-L	923.50	948.80	1370.09	1395.39
	51"(1295mm)	48"(1219mm)	SY	W-2748-L	956.14	986.78	1457.23	1487.87
	57"(1448mm)	54"(1372mm)	SY	W-2754-L	988.78	1024.76	1544.37	1580.35
	63"(1600mm)	60"(1524mm)	SY	W-2760-L	1021.42	1062.74	1631.51	1672.83
	69"(1753mm)	66"(1676mm)	SY	W-2766-L	1054.06	1100.72	1718.65	1765.31
	75"(1905mm)	72"(1829mm)	SY	W-2772-L	1086.70	1138.70	1805.79	1857.79
	81"(2057mm)	78"(1981mm)	SY	W-2778-L	1119.34	1176.68	1892.93	1950.27
	87"(2210mm)	84"(2134mm)	SY	W-2784-L	1151.98	1214.66	1980.07	2042.75
	93"(2362mm)	90"(2286mm)	SY	W-2790-L	1184.62	1252.64	2067.21	2135.23
	99"(2515mm)	96"(2438mm)	SY	W-2796-L	1217.26	1290.62	2154.35	2227.71
	105"(2667mm)	102"(2591mm)	SY	W-27A2-L	1249.90	1328.60	2241.49	2320.19
	111"(2819mm)	108"(2743mm)	SY	W-27A8-L	1282.54	1366.58	2328.63	2412.67
	117"(2972mm)	114"(2896mm)	SY	W-27B4-L	1315.18	1404.56	2415.77	2505.15
34"(864mm)	21"(533mm)	18"(457mm)	SY	W-3418-L	\$ 594.74	\$ 607.57	\$ 823.33	\$ 836.16
	27"(686mm)	24"(610mm)	SY	W-3424-L	627.38	645.55	910.47	928.64
	33"(838mm)	30"(762mm)	SY	W-3430-L	660.02	683.53	997.61	1021.12
	39"(991mm)	36"(914mm)	SY	W-3436-L	848.10	876.95	1240.19	1269.04
	45"(1143mm)	42"(1067mm)	SY	W-3442-L	977.89	1012.08	1424.48	1458.67
	51"(1295mm)	48"(1219mm)	SY	W-3448-L	1010.53	1050.06	1511.62	1551.15
	57"(1448mm)	54"(1372mm)	SY	W-3454-L	1043.17	1088.04	1598.76	1643.63
	63"(1600mm)	60"(1524mm)	SY	W-3460-L	1075.81	1126.02	1685.90	1736.11
	69"(1753mm)	66"(1676mm)	SY	W-3466-L	1108.45	1164.00	1773.04	1828.59
	75"(1905mm)	72"(1829mm)	SY	W-3472-L	1141.09	1201.98	1860.18	1921.07
	81"(2057mm)	78"(1981mm)	SY	W-3478-L	1173.73	1239.96	1947.32	2013.55
	87"(2210mm)	84"(2134mm)	SY	W-3484-L	1206.37	1277.94	2034.46	2106.03
	93"(2362mm)	90"(2286mm)	SY	W-3490-L	1239.01	1315.92	2121.60	2198.51
	99"(2515mm)	96"(2438mm)	SY	W-3496-L	1271.65	1353.90	2208.74	2290.99
	105"(2667mm)	102"(2591mm)	SY	W-34A2-L	1304.29	1391.88	2295.88	2383.47
	111"(2819mm)	108"(2743mm)	SY	W-34A8-L	1336.93	1429.86	2383.02	2475.95
	117"(2972mm)	114"(2896mm)	SY	W-34B4-L	1369.57	1467.84	2470.16	2568.43

Gallery Panel to Compose Panel End-of-Run

L/R (Left or Right Mount)

Nominal Height	Actual Width	Nominal Width	Number		No Glass HPL		Glass Ready HPL	
			①②	③④⑤	A	B	A	B
42"(1067mm)	21"(533mm)	18"(457mm)	SY	W-4218-L	\$ 656.90	\$ 679.89	\$ 885.49	\$ 908.48
	27"(686mm)	24"(610mm)	SY	W-4224-L	689.54	717.87	972.63	1000.96
	33"(838mm)	30"(762mm)	SY	W-4230-L	722.18	755.85	1059.77	1093.44
	39"(991mm)	36"(914mm)	SY	W-4236-L	910.26	949.27	1302.35	1341.36
	45"(1143mm)	42"(1067mm)	SY	W-4242-L	1040.05	1084.40	1486.64	1530.99
	51"(1295mm)	48"(1219mm)	SY	W-4248-L	1072.69	1122.38	1573.78	1623.47
	57"(1448mm)	54"(1372mm)	SY	W-4254-L	1105.33	1160.36	1660.92	1715.95
	63"(1600mm)	60"(1524mm)	SY	W-4260-L	1137.97	1198.34	1748.06	1808.43
	69"(1753mm)	66"(1676mm)	SY	W-4266-L	1170.61	1236.32	1835.20	1900.91
	75"(1905mm)	72"(1829mm)	SY	W-4272-L	1203.25	1274.30	1922.34	1993.39
	81"(2057mm)	78"(1981mm)	SY	W-4278-L	1235.89	1312.28	2009.48	2085.87
	87"(2210mm)	84"(2134mm)	SY	W-4284-L	1268.53	1350.26	2096.62	2178.35
	93"(2362mm)	90"(2286mm)	SY	W-4290-L	1301.17	1388.24	2183.76	2270.83
	99"(2515mm)	96"(2438mm)	SY	W-4296-L	1333.81	1426.22	2270.90	2363.31
	105"(2667mm)	102"(2591mm)	SY	W-42A2-L	1366.45	1464.20	2358.04	2455.79
	111"(2819mm)	108"(2743mm)	SY	W-42A8-L	1399.09	1502.18	2445.18	2548.27
	117"(2972mm)	114"(2896mm)	SY	W-42B4-L	1431.73	1540.16	2532.32	2640.75
Gallery Panels 50"(1270mm)H								
50"(1270mm)	21"(533mm)	18"(457mm)	SY	-5018-L	\$ 719.06	\$ 752.21	\$ 947.65	\$ 980.80
	27"(686mm)	24"(610mm)	SY	-5024-L	751.70	790.19	1034.79	1073.28
	33"(838mm)	30"(762mm)	SY	-5030-L	784.34	828.17	1121.93	1165.76
	39"(991mm)	36"(914mm)	SY	-5036-L	972.42	1021.59	1364.51	1413.68
	45"(1143mm)	42"(1067mm)	SY	-5042-L	1102.21	1156.72	1548.80	1603.31
	51"(1295mm)	48"(1219mm)	SY	-5048-L	1134.85	1194.70	1635.94	1695.79
	57"(1448mm)	54"(1372mm)	SY	-5054-L	1167.49	1232.68	1723.08	1788.27
	63"(1600mm)	60"(1524mm)	SY	-5060-L	1200.13	1270.66	1810.22	1880.75
	69"(1753mm)	66"(1676mm)	SY	-5066-L	1232.77	1308.64	1897.36	1973.23
	75"(1905mm)	72"(1829mm)	SY	-5072-L	1265.41	1346.62	1984.50	2065.71
	81"(2057mm)	78"(1981mm)	SY	-5078-L	1298.05	1384.60	2071.64	2158.19
	87"(2210mm)	84"(2134mm)	SY	-5084-L	1330.69	1422.58	2158.78	2250.67
	93"(2362mm)	90"(2286mm)	SY	-5090-L	1363.33	1460.56	2245.92	2343.15
	99"(2515mm)	96"(2438mm)	SY	-5096-L	1395.97	1498.54	2333.06	2435.63
	105"(2667mm)	102"(2591mm)	SY	-50A2-L	1428.61	1536.52	2420.20	2528.11
	111"(2819mm)	108"(2743mm)	SY	-50A8-L	1461.25	1574.50	2507.34	2620.59
	117"(2972mm)	114"(2896mm)	SY	-50B4-L	1493.89	1612.48	2594.48	2713.07
Gallery Panels 58"(1473mm)H								
58"(1473mm)	21"(533mm)	18"(457mm)	SY	-5818-L	\$ 781.22	\$ 824.53	\$ 1009.81	\$ 1053.12
	27"(686mm)	24"(610mm)	SY	-5824-L	813.86	862.51	1096.95	1145.60
	33"(838mm)	30"(762mm)	SY	-5830-L	846.50	900.49	1184.09	1238.08
	39"(991mm)	36"(914mm)	SY	-5836-L	1034.58	1093.91	1426.67	1486.00
	45"(1143mm)	42"(1067mm)	SY	-5842-L	1164.37	1229.04	1610.96	1675.63
	51"(1295mm)	48"(1219mm)	SY	-5848-L	1197.01	1267.02	1698.10	1768.11
	57"(1448mm)	54"(1372mm)	SY	-5854-L	1229.65	1305.00	1785.24	1860.59
	63"(1600mm)	60"(1524mm)	SY	-5860-L	1262.29	1342.98	1872.38	1953.07

Gallery Panel to Compose Panel End-of-Run W/E (Half Left or Half Right Mount)

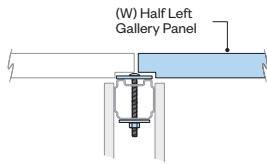
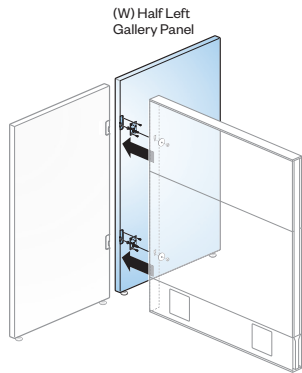

SYWW (Left Face)
SYWZ

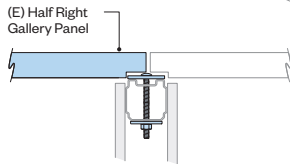
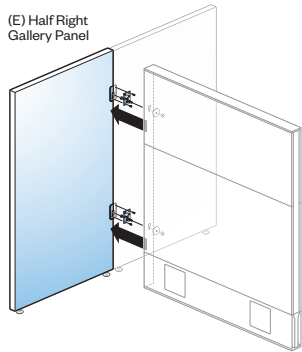

SYEW (Right Face)
SYEZ

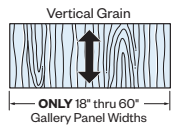
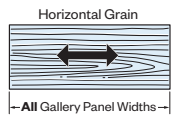

Class BC

Features

- Includes one pre-drilled, finished panel and attachment hardware.
- Gallery Panel is 1.18" (30mm) thick. Half Compose panel adds 1.5" (38mm) to width.
- High Pressure Laminate (HPL) panel has 1mm edgeband.
- Glides provide 1.5" (38mm) level adjustment.
- Rail for glass ready option standard in black.
- Handedness is determined by Face Connection.
- Panel and hardware are field installed.

Specification Tips

- A Half-Left (W) and a Half-Right (E) Gallery Panel are required for this application. Gallery Panel heights must match, widths may be different.
- For use at the end of a Compose panel frame. Takes the place of End-of-Run Trim. Separately specify Variable Height End-of-Run Trim if the Gallery Panel is shorter than the panel application.
- Not for use with Compose Glass Panels.
- Gallery Panels and Compose panel frames can be the same height, lower or taller than each other. Panel frame attachment heights on the Face of the Gallery Panel are available at 26" (660mm)H or 50" (1270mm)H:
 - If the Gallery Panel or panel frame are 42" (1067mm)H or lower, select W (26" (660mm)H) for mounting height.
 - If the Gallery Panel and panel frame are 50" (1270mm)H or higher select Z (50" (1270mm)H) for mounting height.
 - In conditions with Stack Frames, choose connection based on height of panel frame. **DO NOT MATCH HEIGHT OF STACK FRAME(S).**
- Gallery Panel has one Face connection only; select RH or LH.
- Gallery Panel End attachment is not allowed on the same hand as the Face attachment. Refer to the Specification Guide for Face and End mounting application guidelines.
- Specify No Glass option when using Glass Topper Holder Kit.
- "No Glass" Gallery Panels option cannot be retrofit to Glass Ready Option.
- Separately specify:
 - Insert Glass for Glass-Ready Gallery Panels
 - Glass Topper Holder Kit

To Order, Specify:

1) Product number, including:

1 Face Connection Height

- W** 26" (660mm)H-42" (1067mm)H Frame
- Z** 50" (1270mm)H or higher Frame

2 Left End (Finished End or Connection End)

- N** No Connection (Finished End)
- A** 26" (660mm)H Connection (not available for Left-Hand orientation)
- B** 34" (864mm)H Connection (not available for Left-Hand orientation)
- C** 42" (1067mm)H Connection (not available for Left-Hand orientation)
- D** 50" (1270mm)H Connection (not available for Left-Hand orientation)
- E** 58" (1473mm)H Connection (not available for Left-Hand orientation)

3 Right End (Finished End or Connection End)

- N** No Connection (Finished End)
- A** 26" (660mm)H Connection (not available for Right-Hand orientation)
- B** 34" (864mm)H Connection (not available for Right-Hand orientation)
- C** 42" (1067mm)H Connection (not available for Right-Hand orientation)
- D** 50" (1270mm)H Connection (not available for Right-Hand orientation)
- E** 58" (1473mm)H Connection (not available for Right-Hand orientation)

4 Glass Options

- N** No Glass (Finished Top)
- G** Glass Ready

2) Laminate surface color.

3) Edgeband color.

Gallery Panel to Compose Panel End-of-Run W/E (Half Left or Half Right Mount)

Nominal Height	Actual Width	Nominal Width	Number			No Glass HPL		Glass Ready HPL	
			①	②③④		A	B	A	B
East / Right Face Connection									
Gallery Panels 26"(660mm)H-42"(1067mm)H									
26"(660mm)	19.5"(495mm)	18"(457mm)	SYEW-2618-L	N		\$ 532.58	\$ 535.25	\$ 761.17	\$ 763.84
	25.5"(648mm)	24"(610mm)	SYEW-2624-L	N		565.22	573.23	848.31	856.32
	31.5"(800mm)	30"(762mm)	SYEW-2630-L	N		597.86	611.21	935.45	948.80
	37.5"(953mm)	36"(914mm)	SYEW-2636-L	N		785.94	804.63	1178.03	1196.72
	43.5"(1105mm)	42"(1067mm)	SYEW-2642-L	N		915.73	939.76	1362.32	1386.35
	49.5"(1257mm)	48"(1219mm)	SYEW-2648-L	N		948.37	977.74	1449.46	1478.83
	55.5"(1410mm)	54"(1372mm)	SYEW-2654-L	N		981.01	1015.72	1536.60	1571.31
	61.5"(1562mm)	60"(1524mm)	SYEW-2660-L	N		1013.65	1053.70	1623.74	1663.79
	67.5"(1715mm)	66"(1676mm)	SYEW-2666-L	N		1046.29	1091.68	1710.88	1756.27
	73.5"(1867mm)	72"(1829mm)	SYEW-2672-L	N		1078.93	1129.66	1798.02	1848.75
	79.5"(2019mm)	78"(1981mm)	SYEW-2678-L	N		1111.57	1167.64	1885.16	1941.23
	85.5"(2172mm)	84"(2134mm)	SYEW-2684-L	N		1144.21	1205.62	1972.30	2033.71
	91.5"(2324mm)	90"(2286mm)	SYEW-2690-L	N		1176.85	1243.60	2059.44	2126.19
	97.5"(2477mm)	96"(2438mm)	SYEW-2696-L	N		1209.49	1281.58	2146.58	2218.67
	103.5"(2629mm)	102"(2591mm)	SYEW-26A2-L	N		1242.13	1319.56	2233.72	2311.15
	109.5"(2781mm)	108"(2743mm)	SYEW-26A8-L	N		1274.77	1357.54	2320.86	2403.63
	115.5"(2934mm)	114"(2896mm)	SYEW-26B4-L	N		1307.41	1395.52	2408.00	2496.11
27"(686mm)	19.5"(495mm)	18"(457mm)	SYEW-2718-L	N		\$ 540.35	\$ 544.29	\$ 768.94	\$ 772.88
	25.5"(648mm)	24"(610mm)	SYEW-2724-L	N		572.99	582.27	856.08	865.36
	31.5"(800mm)	30"(762mm)	SYEW-2730-L	N		605.63	620.25	943.22	957.84
	37.5"(953mm)	36"(914mm)	SYEW-2736-L	N		793.71	813.67	1185.80	1205.76
	43.5"(1105mm)	42"(1067mm)	SYEW-2742-L	N		923.50	948.80	1370.09	1395.39
	49.5"(1257mm)	48"(1219mm)	SYEW-2748-L	N		956.14	986.78	1457.23	1487.87
	55.5"(1410mm)	54"(1372mm)	SYEW-2754-L	N		988.78	1024.76	1544.37	1580.35
	61.5"(1562mm)	60"(1524mm)	SYEW-2760-L	N		1021.42	1062.74	1631.51	1672.83
	67.5"(1715mm)	66"(1676mm)	SYEW-2766-L	N		1054.06	1100.72	1718.65	1765.31
	73.5"(1867mm)	72"(1829mm)	SYEW-2772-L	N		1086.70	1138.70	1805.79	1857.79
	79.5"(2019mm)	78"(1981mm)	SYEW-2778-L	N		1119.34	1176.68	1892.93	1950.27
	85.5"(2172mm)	84"(2134mm)	SYEW-2784-L	N		1151.98	1214.66	1980.07	2042.75
	91.5"(2324mm)	90"(2286mm)	SYEW-2790-L	N		1184.62	1252.64	2067.21	2135.23
	97.5"(2477mm)	96"(2438mm)	SYEW-2796-L	N		1217.26	1290.62	2154.35	2227.71
	103.5"(2629mm)	102"(2591mm)	SYEW-27A2-L	N		1249.90	1328.60	2241.49	2320.19
	109.5"(2781mm)	108"(2743mm)	SYEW-27A8-L	N		1282.54	1366.58	2328.63	2412.67
	115.5"(2934mm)	114"(2896mm)	SYEW-27B4-L	N		1315.18	1404.56	2415.77	2505.15
34"(864mm)	19.5"(495mm)	18"(457mm)	SYEW-3418-L	N		\$ 594.74	\$ 607.57	\$ 823.33	\$ 836.16
	25.5"(648mm)	24"(610mm)	SYEW-3424-L	N		627.38	645.55	910.47	928.64
	31.5"(800mm)	30"(762mm)	SYEW-3430-L	N		660.02	683.53	997.61	1021.12
	37.5"(953mm)	36"(914mm)	SYEW-3436-L	N		848.10	876.95	1240.19	1269.04
	43.5"(1105mm)	42"(1067mm)	SYEW-3442-L	N		977.89	1012.08	1424.48	1458.67
	49.5"(1257mm)	48"(1219mm)	SYEW-3448-L	N		1010.53	1050.06	1511.62	1551.15
	55.5"(1410mm)	54"(1372mm)	SYEW-3454-L	N		1043.17	1088.04	1598.76	1643.63
	61.5"(1562mm)	60"(1524mm)	SYEW-3460-L	N		1075.81	1126.02	1685.90	1736.11
	67.5"(1715mm)	66"(1676mm)	SYEW-3466-L	N		1108.45	1164.00	1773.04	1828.59
	73.5"(1867mm)	72"(1829mm)	SYEW-3472-L	N		1141.09	1201.98	1860.18	1921.07
	79.5"(2019mm)	78"(1981mm)	SYEW-3478-L	N		1173.73	1239.96	1947.32	2013.55
	85.5"(2172mm)	84"(2134mm)	SYEW-3484-L	N		1206.37	1277.94	2034.46	2106.03
	91.5"(2324mm)	90"(2286mm)	SYEW-3490-L	N		1239.01	1315.92	2121.60	2198.51
	97.5"(2477mm)	96"(2438mm)	SYEW-3496-L	N		1271.65	1353.90	2208.74	2290.99
	103.5"(2629mm)	102"(2591mm)	SYEW-34A2-L	N		1304.29	1391.88	2295.88	2383.47
	109.5"(2781mm)	108"(2743mm)	SYEW-34A8-L	N		1336.93	1429.86	2383.02	2475.95
	115.5"(2934mm)	114"(2896mm)	SYEW-34B4-L	N		1369.57	1467.84	2470.16	2568.43

Gallery Panel to Compose Panel End-of-Run W/E (Half Left or Half Right Mount)

Nominal Height	Actual Width	Nominal Width	Number		No Glass HPL		Glass Ready HPL	
			①	②③④	A	B	A	B
42"(1067mm)	19.5"(495mm)	18"(457mm)	SYEW-4218-L	N	\$ 656.90	\$ 679.89	\$ 885.49	\$ 908.48
	25.5"(648mm)	24"(610mm)	SYEW-4224-L	N	689.54	717.87	972.63	1000.96
	31.5"(800mm)	30"(762mm)	SYEW-4230-L	N	722.18	755.85	1059.77	1093.44
	37.5"(953mm)	36"(914mm)	SYEW-4236-L	N	910.26	949.27	1302.35	1341.36
	43.5"(1105mm)	42"(1067mm)	SYEW-4242-L	N	1040.05	1084.40	1486.64	1530.99
	49.5"(1257mm)	48"(1219mm)	SYEW-4248-L	N	1072.69	1122.38	1573.78	1623.47
	55.5"(1410mm)	54"(1372mm)	SYEW-4254-L	N	1105.33	1160.36	1660.92	1715.95
	61.5"(1562mm)	60"(1524mm)	SYEW-4260-L	N	1137.97	1198.34	1748.06	1808.43
	67.5"(1715mm)	66"(1676mm)	SYEW-4266-L	N	1170.61	1236.32	1835.20	1900.91
	73.5"(1867mm)	72"(1829mm)	SYEW-4272-L	N	1203.25	1274.30	1922.34	1993.39
	79.5"(2019mm)	78"(1981mm)	SYEW-4278-L	N	1235.89	1312.28	2009.48	2085.87
	85.5"(2172mm)	84"(2134mm)	SYEW-4284-L	N	1268.53	1350.26	2096.62	2178.35
	91.5"(2324mm)	90"(2286mm)	SYEW-4290-L	N	1301.17	1388.24	2183.76	2270.83
	97.5"(2477mm)	96"(2438mm)	SYEW-4296-L	N	1333.81	1426.22	2270.90	2363.31
	103.5"(2629mm)	102"(2591mm)	SYEW-42A2-L	N	1366.45	1464.20	2358.04	2455.79
	109.5"(2781mm)	108"(2743mm)	SYEW-42A8-L	N	1399.09	1502.18	2445.18	2548.27
	115.5"(2934mm)	114"(2896mm)	SYEW-42B4-L	N	1431.73	1540.16	2532.32	2640.75
Gallery Panels 50"(1270mm)H								
50"(1270mm)	19.5"(495mm)	18"(457mm)	SYE -5018-L	N	\$ 719.06	\$ 752.21	\$ 947.65	\$ 980.80
	25.5"(648mm)	24"(610mm)	SYE -5024-L	N	751.70	790.19	1034.79	1073.28
	31.5"(800mm)	30"(762mm)	SYE -5030-L	N	784.34	828.17	1121.93	1165.76
	37.5"(953mm)	36"(914mm)	SYE -5036-L	N	972.42	1021.59	1364.51	1413.68
	43.5"(1105mm)	42"(1067mm)	SYE -5042-L	N	1102.21	1156.72	1548.80	1603.31
	49.5"(1257mm)	48"(1219mm)	SYE -5048-L	N	1134.85	1194.70	1635.94	1695.79
	55.5"(1410mm)	54"(1372mm)	SYE -5054-L	N	1167.49	1232.68	1723.08	1788.27
	61.5"(1562mm)	60"(1524mm)	SYE -5060-L	N	1200.13	1270.66	1810.22	1880.75
	67.5"(1715mm)	66"(1676mm)	SYE -5066-L	N	1232.77	1308.64	1897.36	1973.23
	73.5"(1867mm)	72"(1829mm)	SYE -5072-L	N	1265.41	1346.62	1984.50	2065.71
	79.5"(2019mm)	78"(1981mm)	SYE -5078-L	N	1298.05	1384.60	2071.64	2158.19
	85.5"(2172mm)	84"(2134mm)	SYE -5084-L	N	1330.69	1422.58	2158.78	2250.67
	91.5"(2324mm)	90"(2286mm)	SYE -5090-L	N	1363.33	1460.56	2245.92	2343.15
	97.5"(2477mm)	96"(2438mm)	SYE -5096-L	N	1395.97	1498.54	2333.06	2435.63
	103.5"(2629mm)	102"(2591mm)	SYE -50A2-L	N	1428.61	1536.52	2420.20	2528.11
	109.5"(2781mm)	108"(2743mm)	SYE -50A8-L	N	1461.25	1574.50	2507.34	2620.59
	115.5"(2934mm)	114"(2896mm)	SYE -50B4-L	N	1493.89	1612.48	2594.48	2713.07
Gallery Panels 58"(1473mm)H								
58"(1473mm)	19.5"(495mm)	18"(457mm)	SYE -5818-L	N	\$ 781.22	\$ 824.53	\$ 1009.81	\$ 1053.12
	25.5"(648mm)	24"(610mm)	SYE -5824-L	N	813.86	862.51	1096.95	1145.60
	31.5"(800mm)	30"(762mm)	SYE -5830-L	N	846.50	900.49	1184.09	1238.08
	37.5"(953mm)	36"(914mm)	SYE -5836-L	N	1034.58	1093.91	1426.67	1486.00
	43.5"(1105mm)	42"(1067mm)	SYE -5842-L	N	1164.37	1229.04	1610.96	1675.63
	49.5"(1257mm)	48"(1219mm)	SYE -5848-L	N	1197.01	1267.02	1698.10	1768.11
	55.5"(1410mm)	54"(1372mm)	SYE -5854-L	N	1229.65	1305.00	1785.24	1860.59
	61.5"(1562mm)	60"(1524mm)	SYE -5860-L	N	1262.29	1342.98	1872.38	1953.07

Gallery Panel to Compose Panel End-of-Run W/E (Half Left or Half Right Mount)

Nominal Height	Actual Width	Nominal Width	Number			No Glass HPL		Glass Ready HPL	
			①	②③④		A	B	A	B
West / Left Face Connection									
Gallery Panels 26"(660mm)H-42"(1067mm)H									
26"(660mm)	19.5"(495mm)	18"(457mm)	SYWW-2618-LN			\$ 532.58	\$ 535.25	\$ 761.17	\$ 763.84
	25.5"(648mm)	24"(610mm)	SYWW-2624-LN			565.22	573.23	848.31	856.32
	31.5"(800mm)	30"(762mm)	SYWW-2630-LN			597.86	611.21	935.45	948.80
	37.5"(953mm)	36"(914mm)	SYWW-2636-LN			785.94	804.63	1178.03	1196.72
	43.5"(1105mm)	42"(1067mm)	SYWW-2642-LN			915.73	939.76	1362.32	1386.35
	49.5"(1257mm)	48"(1219mm)	SYWW-2648-LN			948.37	977.74	1449.46	1478.83
	55.5"(1410mm)	54"(1372mm)	SYWW-2654-LN			981.01	1015.72	1536.60	1571.31
	61.5"(1562mm)	60"(1524mm)	SYWW-2660-LN			1013.65	1053.70	1623.74	1663.79
	67.5"(1715mm)	66"(1676mm)	SYWW-2666-LN			1046.29	1091.68	1710.88	1756.27
	73.5"(1867mm)	72"(1829mm)	SYWW-2672-LN			1078.93	1129.66	1798.02	1848.75
	79.5"(2019mm)	78"(1981mm)	SYWW-2678-LN			1111.57	1167.64	1885.16	1941.23
	85.5"(2172mm)	84"(2134mm)	SYWW-2684-LN			1144.21	1205.62	1972.30	2033.71
	91.5"(2324mm)	90"(2286mm)	SYWW-2690-LN			1176.85	1243.60	2059.44	2126.19
	97.5"(2477mm)	96"(2438mm)	SYWW-2696-LN			1209.49	1281.58	2146.58	2218.67
	103.5"(2629mm)	102"(2591mm)	SYWW-26A2-LN			1242.13	1319.56	2233.72	2311.15
	109.5"(2781mm)	108"(2743mm)	SYWW-26A8-LN			1274.77	1357.54	2320.86	2403.63
	115.5"(2934mm)	114"(2896mm)	SYWW-26B4-LN			1307.41	1395.52	2408.00	2496.11
27"(686mm)	19.5"(495mm)	18"(457mm)	SYWW-2718-LN			\$ 540.35	\$ 544.29	\$ 768.94	\$ 772.88
	25.5"(648mm)	24"(610mm)	SYWW-2724-LN			572.99	582.27	856.08	865.36
	31.5"(800mm)	30"(762mm)	SYWW-2730-LN			605.63	620.25	943.22	957.84
	37.5"(953mm)	36"(914mm)	SYWW-2736-LN			793.71	813.67	1185.80	1205.76
	43.5"(1105mm)	42"(1067mm)	SYWW-2742-LN			923.50	948.80	1370.09	1395.39
	49.5"(1257mm)	48"(1219mm)	SYWW-2748-LN			956.14	986.78	1457.23	1487.87
	55.5"(1410mm)	54"(1372mm)	SYWW-2754-LN			988.78	1024.76	1544.37	1580.35
	61.5"(1562mm)	60"(1524mm)	SYWW-2760-LN			1021.42	1062.74	1631.51	1672.83
	67.5"(1715mm)	66"(1676mm)	SYWW-2766-LN			1054.06	1100.72	1718.65	1765.31
	73.5"(1867mm)	72"(1829mm)	SYWW-2772-LN			1086.70	1138.70	1805.79	1857.79
	79.5"(2019mm)	78"(1981mm)	SYWW-2778-LN			1119.34	1176.68	1892.93	1950.27
	85.5"(2172mm)	84"(2134mm)	SYWW-2784-LN			1151.98	1214.66	1980.07	2042.75
	91.5"(2324mm)	90"(2286mm)	SYWW-2790-LN			1184.62	1252.64	2067.21	2135.23
	97.5"(2477mm)	96"(2438mm)	SYWW-2796-LN			1217.26	1290.62	2154.35	2227.71
	103.5"(2629mm)	102"(2591mm)	SYWW-27A2-LN			1249.90	1328.60	2241.49	2320.19
	109.5"(2781mm)	108"(2743mm)	SYWW-27A8-LN			1282.54	1366.58	2328.63	2412.67
	115.5"(2934mm)	114"(2896mm)	SYWW-27B4-LN			1315.18	1404.56	2415.77	2505.15
34"(864mm)	19.5"(495mm)	18"(457mm)	SYWW-3418-LN			\$ 594.74	\$ 607.57	\$ 823.33	\$ 836.16
	25.5"(648mm)	24"(610mm)	SYWW-3424-LN			627.38	645.55	910.47	928.64
	31.5"(800mm)	30"(762mm)	SYWW-3430-LN			660.02	683.53	997.61	1021.12
	37.5"(953mm)	36"(914mm)	SYWW-3436-LN			848.10	876.95	1240.19	1269.04
	43.5"(1105mm)	42"(1067mm)	SYWW-3442-LN			977.89	1012.08	1424.48	1458.67
	49.5"(1257mm)	48"(1219mm)	SYWW-3448-LN			1010.53	1050.06	1511.62	1551.15
	55.5"(1410mm)	54"(1372mm)	SYWW-3454-LN			1043.17	1088.04	1598.76	1643.63
	61.5"(1562mm)	60"(1524mm)	SYWW-3460-LN			1075.81	1126.02	1685.90	1736.11
	67.5"(1715mm)	66"(1676mm)	SYWW-3466-LN			1108.45	1164.00	1773.04	1828.59
	73.5"(1867mm)	72"(1829mm)	SYWW-3472-LN			1141.09	1201.98	1860.18	1921.07
	79.5"(2019mm)	78"(1981mm)	SYWW-3478-LN			1173.73	1239.96	1947.32	2013.55
	85.5"(2172mm)	84"(2134mm)	SYWW-3484-LN			1206.37	1277.94	2034.46	2106.03
	91.5"(2324mm)	90"(2286mm)	SYWW-3490-LN			1239.01	1315.92	2121.60	2198.51
	97.5"(2477mm)	96"(2438mm)	SYWW-3496-LN			1271.65	1353.90	2208.74	2290.99
	103.5"(2629mm)	102"(2591mm)	SYWW-34A2-LN			1304.29	1391.88	2295.88	2383.47
	109.5"(2781mm)	108"(2743mm)	SYWW-34A8-LN			1336.93	1429.86	2383.02	2475.95
	115.5"(2934mm)	114"(2896mm)	SYWW-34B4-LN			1369.57	1467.84	2470.16	2568.43

Gallery Panel to Compose Panel End-of-Run W/E (Half Left or Half Right Mount)

Nominal Height	Actual Width	Nominal Width	Number		No Glass HPL		Glass Ready HPL	
			①	②③④	A	B	A	B
42"(1067mm)	19.5"(495mm)	18"(457mm)	SYWW-4218-LN	■ ■	\$ 656.90	\$ 679.89	\$ 885.49	\$ 908.48
	25.5"(648mm)	24"(610mm)	SYWW-4224-LN	■ ■	689.54	717.87	972.63	1000.96
	31.5"(800mm)	30"(762mm)	SYWW-4230-LN	■ ■	722.18	755.85	1059.77	1093.44
	37.5"(953mm)	36"(914mm)	SYWW-4236-LN	■ ■	910.26	949.27	1302.35	1341.36
	43.5"(1105mm)	42"(1067mm)	SYWW-4242-LN	■ ■	1040.05	1084.40	1486.64	1530.99
	49.5"(1257mm)	48"(1219mm)	SYWW-4248-LN	■ ■	1072.69	1122.38	1573.78	1623.47
	55.5"(1410mm)	54"(1372mm)	SYWW-4254-LN	■ ■	1105.33	1160.36	1660.92	1715.95
	61.5"(1562mm)	60"(1524mm)	SYWW-4260-LN	■ ■	1137.97	1198.34	1748.06	1808.43
	67.5"(1715mm)	66"(1676mm)	SYWW-4266-LN	■ ■	1170.61	1236.32	1835.20	1900.91
	73.5"(1867mm)	72"(1829mm)	SYWW-4272-LN	■ ■	1203.25	1274.30	1922.34	1993.39
	79.5"(2019mm)	78"(1981mm)	SYWW-4278-LN	■ ■	1235.89	1312.28	2009.48	2085.87
	85.5"(2172mm)	84"(2134mm)	SYWW-4284-LN	■ ■	1268.53	1350.26	2096.62	2178.35
	91.5"(2324mm)	90"(2286mm)	SYWW-4290-LN	■ ■	1301.17	1388.24	2183.76	2270.83
	97.5"(2477mm)	96"(2438mm)	SYWW-4296-LN	■ ■	1333.81	1426.22	2270.90	2363.31
	103.5"(2629mm)	102"(2591mm)	SYWW-42A2-LN	■ ■	1366.45	1464.20	2358.04	2455.79
	109.5"(2781mm)	108"(2743mm)	SYWW-42A8-LN	■ ■	1399.09	1502.18	2445.18	2548.27
	115.5"(2934mm)	114"(2896mm)	SYWW-42B4-LN	■ ■	1431.73	1540.16	2532.32	2640.75
Gallery Panels 50"(1270mm)H								
50"(1270mm)	19.5"(495mm)	18"(457mm)	SYW -5018-LN	■ ■	\$ 719.06	\$ 752.21	\$ 947.65	\$ 980.80
	25.5"(648mm)	24"(610mm)	SYW -5024-LN	■ ■	751.70	790.19	1034.79	1073.28
	31.5"(800mm)	30"(762mm)	SYW -5030-LN	■ ■	784.34	828.17	1121.93	1165.76
	37.5"(953mm)	36"(914mm)	SYW -5036-LN	■ ■	972.42	1021.59	1364.51	1413.68
	43.5"(1105mm)	42"(1067mm)	SYW -5042-LN	■ ■	1102.21	1156.72	1548.80	1603.31
	49.5"(1257mm)	48"(1219mm)	SYW -5048-LN	■ ■	1134.85	1194.70	1635.94	1695.79
	55.5"(1410mm)	54"(1372mm)	SYW -5054-LN	■ ■	1167.49	1232.68	1723.08	1788.27
	61.5"(1562mm)	60"(1524mm)	SYW -5060-LN	■ ■	1200.13	1270.66	1810.22	1880.75
	67.5"(1715mm)	66"(1676mm)	SYW -5066-LN	■ ■	1232.77	1308.64	1897.36	1973.23
	73.5"(1867mm)	72"(1829mm)	SYW -5072-LN	■ ■	1265.41	1346.62	1984.50	2065.71
	79.5"(2019mm)	78"(1981mm)	SYW -5078-LN	■ ■	1298.05	1384.60	2071.64	2158.19
	85.5"(2172mm)	84"(2134mm)	SYW -5084-LN	■ ■	1330.69	1422.58	2158.78	2250.67
	91.5"(2324mm)	90"(2286mm)	SYW -5090-LN	■ ■	1363.33	1460.56	2245.92	2343.15
	97.5"(2477mm)	96"(2438mm)	SYW -5096-LN	■ ■	1395.97	1498.54	2333.06	2435.63
	103.5"(2629mm)	102"(2591mm)	SYW -50A2-LN	■ ■	1428.61	1536.52	2420.20	2528.11
	109.5"(2781mm)	108"(2743mm)	SYW -50A8-LN	■ ■	1461.25	1574.50	2507.34	2620.59
	115.5"(2934mm)	114"(2896mm)	SYW -50B4-LN	■ ■	1493.89	1612.48	2594.48	2713.07
Gallery Panels 58"(1473mm)H								
58"(1473mm)	19.5"(495mm)	18"(457mm)	SYW -5818-LN	■ ■	\$ 781.22	\$ 824.53	\$ 1009.81	\$ 1053.12
	25.5"(648mm)	24"(610mm)	SYW -5824-LN	■ ■	813.86	862.51	1096.95	1145.60
	31.5"(800mm)	30"(762mm)	SYW -5830-LN	■ ■	846.50	900.49	1184.09	1238.08
	37.5"(953mm)	36"(914mm)	SYW -5836-LN	■ ■	1034.58	1093.91	1426.67	1486.00
	43.5"(1105mm)	42"(1067mm)	SYW -5842-LN	■ ■	1164.37	1229.04	1610.96	1675.63
	49.5"(1257mm)	48"(1219mm)	SYW -5848-LN	■ ■	1197.01	1267.02	1698.10	1768.11
	55.5"(1410mm)	54"(1372mm)	SYW -5854-LN	■ ■	1229.65	1305.00	1785.24	1860.59
	61.5"(1562mm)	60"(1524mm)	SYW -5860-LN	■ ■	1262.29	1342.98	1872.38	1953.07

Gallery Panel to Compose Panel End-of-Run C (Center Mount)

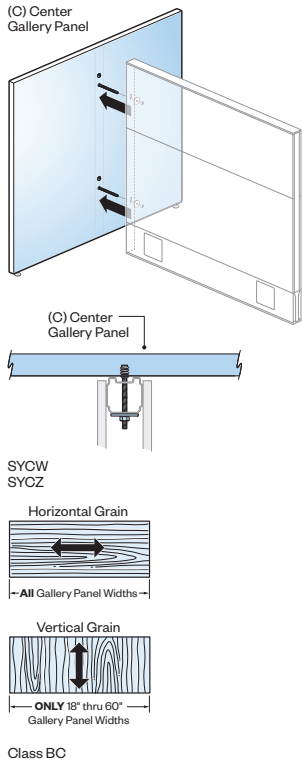

Class BC

Features

- Includes one pre-drilled, finished panel and attachment hardware.
- Gallery Panel is 1.18”(30mm) thick. Compose panel adds 3”(76mm) to width.
- High Pressured Laminate (HPL) panel has 1mm edgeband.
- Glides provide 1.5”(38mm) level adjustment.
- Panel and hardware are field installed.
- Rail for glass ready option standard in black.
- Handedness is determined by Face Connection.

Specification Tips

- For use at the end of a Compose panel frame. Takes the place of End-of-Run Trim. Separately specify Variable Height End-of-Run Trim if the Gallery Panel is shorter than the panel application.
- Not for use with Compose Glass Panels.
- Gallery Panels and Compose panel frames can be the same height, lower or taller than each other. Compose panel frame attachment heights on the Face of the Gallery Panel are available at 26”(660mm)H or 50”(1270mm)H:
 - If the Gallery Panel or Compose panel frame are 42”(1067mm)H or lower, select W (26”(660mm)H) for mounting height.
 - If the Gallery Panel and Compose panel frame are 50”(1270mm)H or higher select Z (50”(1270mm)H) for mounting height.
 - In conditions with Stack Frames, choose connection based on height of panel frame. **DO NOT MATCH HEIGHT OF STACK FRAME(S).**
- Gallery Panel has one center Face connection only.
- Refer to the Specification Guide for Face and End mounting application guidelines.
- Specify No Glass option when using Glass Topper Holder Kit.
- “No Glass” Gallery Panels option cannot be retrofit to Glass Ready Option.
- Separately specify:
 - Insert Glass for Glass-Ready Gallery Panels
 - Glass Topper Holder Kit

To Order, Specify:

1) Product number, including:

1 Face Connection Height

- W** 26”(660mm)H-42”(1067mm)H Frame
- Z** 50”(1270mm)H or higher Frame

2 Left End (Finished End or Connection End)

- N** No Connection (Finished End)
- A** 26”(660mm)H Connection (not available for Left-Hand orientation)
- B** 34”(864mm)H Connection (not available for Left-Hand orientation)
- C** 42”(1067mm)H Connection (not available for Left-Hand orientation)
- D** 50”(1270mm)H Connection (not available for Left-Hand orientation)
- E** 58”(1473mm)H Connection (not available for Left-Hand orientation)

3 Right End (Finished End or Connection End)

- N** No Connection (Finished End)
- A** 26”(660mm)H Connection (not available for Right-Hand orientation)
- B** 34”(864mm)H Connection (not available for Right-Hand orientation)
- C** 42”(1067mm)H Connection (not available for Right-Hand orientation)
- D** 50”(1270mm)H Connection (not available for Right-Hand orientation)
- E** 58”(1473mm)H Connection (not available for Right-Hand orientation)

4 Glass Options

- N** No Glass (Finished Top)
- G** Glass Ready

2) Laminate surface color.

3) Edgeband color.

Gallery Panel to Compose Panel End-of-Run C (Center Mount)

Nominal Height	Actual Width	Nominal Width	Number		No Glass HPL		Glass Ready HPL	
			①	②③④	A	B	A	B
Gallery Panels 26"(660mm)H-42"(1067mm)H								
26"(660mm)	21"(533mm)	18"(457mm)	SYCW-2618-L	■ ■ ■ ■	\$ 532.58	\$ 535.25	\$ 761.17	\$ 763.84
	27"(686mm)	24"(610mm)	SYCW-2624-L	■ ■ ■ ■	565.22	573.23	848.31	856.32
	33"(838mm)	30"(762mm)	SYCW-2630-L	■ ■ ■ ■	597.86	611.21	935.45	948.80
	39"(991mm)	36"(914mm)	SYCW-2636-L	■ ■ ■ ■	785.94	804.63	1178.03	1196.72
	45"(1143mm)	42"(1067mm)	SYCW-2642-L	■ ■ ■ ■	915.73	939.76	1362.32	1386.35
	51"(1295mm)	48"(1219mm)	SYCW-2648-L	■ ■ ■ ■	948.37	977.74	1449.46	1478.83
	57"(1448mm)	54"(1372mm)	SYCW-2654-L	■ ■ ■ ■	981.01	1015.72	1536.60	1571.31
	63"(1600mm)	60"(1524mm)	SYCW-2660-L	■ ■ ■ ■	1013.65	1053.70	1623.74	1663.79
	69"(1753mm)	66"(1676mm)	SYCW-2666-L	■ ■ ■ ■	1046.29	1091.68	1710.88	1756.27
	75"(1905mm)	72"(1829mm)	SYCW-2672-L	■ ■ ■ ■	1078.93	1129.66	1798.02	1848.75
	81"(2057mm)	78"(1981mm)	SYCW-2678-L	■ ■ ■ ■	1111.57	1167.64	1885.16	1941.23
	87"(2210mm)	84"(2134mm)	SYCW-2684-L	■ ■ ■ ■	1144.21	1205.62	1972.30	2033.71
	93"(2362mm)	90"(2286mm)	SYCW-2690-L	■ ■ ■ ■	1176.85	1243.60	2059.44	2126.19
	99"(2515mm)	96"(2438mm)	SYCW-2696-L	■ ■ ■ ■	1209.49	1281.58	2146.58	2218.67
	105"(2667mm)	102"(2591mm)	SYCW-26A2-L	■ ■ ■ ■	1242.13	1319.56	2233.72	2311.15
	111"(2819mm)	108"(2743mm)	SYCW-26A8-L	■ ■ ■ ■	1274.77	1357.54	2320.86	2403.63
	117"(2972mm)	114"(2896mm)	SYCW-26B4-L	■ ■ ■ ■	1307.41	1395.52	2408.00	2496.11
27"(686mm)	21"(533mm)	18"(457mm)	SYCW-2718-L	■ ■ ■ ■	\$ 540.35	\$ 544.29	\$ 768.94	\$ 772.88
	27"(686mm)	24"(610mm)	SYCW-2724-L	■ ■ ■ ■	572.99	582.27	856.08	865.36
	33"(838mm)	30"(762mm)	SYCW-2730-L	■ ■ ■ ■	605.63	620.25	943.22	957.84
	39"(991mm)	36"(914mm)	SYCW-2736-L	■ ■ ■ ■	793.71	813.67	1185.80	1205.76
	45"(1143mm)	42"(1067mm)	SYCW-2742-L	■ ■ ■ ■	923.50	948.80	1370.09	1395.39
	51"(1295mm)	48"(1219mm)	SYCW-2748-L	■ ■ ■ ■	956.14	986.78	1457.23	1487.87
	57"(1448mm)	54"(1372mm)	SYCW-2754-L	■ ■ ■ ■	988.78	1024.76	1544.37	1580.35
	63"(1600mm)	60"(1524mm)	SYCW-2760-L	■ ■ ■ ■	1021.42	1062.74	1631.51	1672.83
	69"(1753mm)	66"(1676mm)	SYCW-2766-L	■ ■ ■ ■	1054.06	1100.72	1718.65	1765.31
	75"(1905mm)	72"(1829mm)	SYCW-2772-L	■ ■ ■ ■	1086.70	1138.70	1805.79	1857.79
	81"(2057mm)	78"(1981mm)	SYCW-2778-L	■ ■ ■ ■	1119.34	1176.68	1892.93	1950.27
	87"(2210mm)	84"(2134mm)	SYCW-2784-L	■ ■ ■ ■	1151.98	1214.66	1980.07	2042.75
	93"(2362mm)	90"(2286mm)	SYCW-2790-L	■ ■ ■ ■	1184.62	1252.64	2067.21	2135.23
	99"(2515mm)	96"(2438mm)	SYCW-2796-L	■ ■ ■ ■	1217.26	1290.62	2154.35	2227.71
	105"(2667mm)	102"(2591mm)	SYCW-27A2-L	■ ■ ■ ■	1249.90	1328.60	2241.49	2320.19
	111"(2819mm)	108"(2743mm)	SYCW-27A8-L	■ ■ ■ ■	1282.54	1366.58	2328.63	2412.67
	117"(2972mm)	114"(2896mm)	SYCW-27B4-L	■ ■ ■ ■	1315.18	1404.56	2415.77	2505.15
34"(864mm)	21"(533mm)	18"(457mm)	SYCW-3418-L	■ ■ ■ ■	\$ 594.74	\$ 607.57	\$ 823.33	\$ 836.16
	27"(686mm)	24"(610mm)	SYCW-3424-L	■ ■ ■ ■	627.38	645.55	910.47	928.64
	33"(838mm)	30"(762mm)	SYCW-3430-L	■ ■ ■ ■	660.02	683.53	997.61	1021.12
	39"(991mm)	36"(914mm)	SYCW-3436-L	■ ■ ■ ■	848.10	876.95	1240.19	1269.04
	45"(1143mm)	42"(1067mm)	SYCW-3442-L	■ ■ ■ ■	977.89	1012.08	1424.48	1458.67
	51"(1295mm)	48"(1219mm)	SYCW-3448-L	■ ■ ■ ■	1010.53	1050.06	1511.62	1551.15
	57"(1448mm)	54"(1372mm)	SYCW-3454-L	■ ■ ■ ■	1043.17	1088.04	1598.76	1643.63
	63"(1600mm)	60"(1524mm)	SYCW-3460-L	■ ■ ■ ■	1075.81	1126.02	1685.90	1736.11
	69"(1753mm)	66"(1676mm)	SYCW-3466-L	■ ■ ■ ■	1108.45	1164.00	1773.04	1828.59
	75"(1905mm)	72"(1829mm)	SYCW-3472-L	■ ■ ■ ■	1141.09	1201.98	1860.18	1921.07
	81"(2057mm)	78"(1981mm)	SYCW-3478-L	■ ■ ■ ■	1173.73	1239.96	1947.32	2013.55
	87"(2210mm)	84"(2134mm)	SYCW-3484-L	■ ■ ■ ■	1206.37	1277.94	2034.46	2106.03
	93"(2362mm)	90"(2286mm)	SYCW-3490-L	■ ■ ■ ■	1239.01	1315.92	2121.60	2198.51
	99"(2515mm)	96"(2438mm)	SYCW-3496-L	■ ■ ■ ■	1271.65	1353.90	2208.74	2290.99
	105"(2667mm)	102"(2591mm)	SYCW-34A2-L	■ ■ ■ ■	1304.29	1391.88	2295.88	2383.47
	111"(2819mm)	108"(2743mm)	SYCW-34A8-L	■ ■ ■ ■	1336.93	1429.86	2383.02	2475.95
	117"(2972mm)	114"(2896mm)	SYCW-34B4-L	■ ■ ■ ■	1369.57	1467.84	2470.16	2568.43

Gallery Panel to Compose Panel End-of-Run C (Center Mount)

Nominal Height	Actual Width	Nominal Width	Number		No Glass HPL		Glass Ready HPL	
			①	②③④	A	B	A	B
42"(1067mm)	21"(533mm)	18"(457mm)	SYCW-4218-L	■■■■	\$ 656.90	\$ 679.89	\$ 885.49	\$ 908.48
	27"(686mm)	24"(610mm)	SYCW-4224-L	■■■■	689.54	717.87	972.63	1000.96
	33"(838mm)	30"(762mm)	SYCW-4230-L	■■■■	722.18	755.85	1059.77	1093.44
	39"(991mm)	36"(914mm)	SYCW-4236-L	■■■■	910.26	949.27	1302.35	1341.36
	45"(1143mm)	42"(1067mm)	SYCW-4242-L	■■■■	1040.05	1084.40	1486.64	1530.99
	51"(1295mm)	48"(1219mm)	SYCW-4248-L	■■■■	1072.69	1122.38	1573.78	1623.47
	57"(1448mm)	54"(1372mm)	SYCW-4254-L	■■■■	1105.33	1160.36	1660.92	1715.95
	63"(1600mm)	60"(1524mm)	SYCW-4260-L	■■■■	1137.97	1198.34	1748.06	1808.43
	69"(1753mm)	66"(1676mm)	SYCW-4266-L	■■■■	1170.61	1236.32	1835.20	1900.91
	75"(1905mm)	72"(1829mm)	SYCW-4272-L	■■■■	1203.25	1274.30	1922.34	1993.39
	81"(2057mm)	78"(1981mm)	SYCW-4278-L	■■■■	1235.89	1312.28	2009.48	2085.87
	87"(2210mm)	84"(2134mm)	SYCW-4284-L	■■■■	1268.53	1350.26	2096.62	2178.35
	93"(2362mm)	90"(2286mm)	SYCW-4290-L	■■■■	1301.17	1388.24	2183.76	2270.83
	99"(2515mm)	96"(2438mm)	SYCW-4296-L	■■■■	1333.81	1426.22	2270.90	2363.31
	105"(2667mm)	102"(2591mm)	SYCW-42A2-L	■■■■	1366.45	1464.20	2358.04	2455.79
	111"(2819mm)	108"(2743mm)	SYCW-42A8-L	■■■■	1399.09	1502.18	2445.18	2548.27
	117"(2972mm)	114"(2896mm)	SYCW-42B4-L	■■■■	1431.73	1540.16	2532.32	2640.75
Gallery Panels 50"(1270mm)H								
50"(1270mm)	21"(533mm)	18"(457mm)	SYC -5018-L	■■■■	\$ 719.06	\$ 752.21	\$ 947.65	\$ 980.80
	27"(686mm)	24"(610mm)	SYC -5024-L	■■■■	751.70	790.19	1034.79	1073.28
	33"(838mm)	30"(762mm)	SYC -5030-L	■■■■	784.34	828.17	1121.93	1165.76
	39"(991mm)	36"(914mm)	SYC -5036-L	■■■■	972.42	1021.59	1364.51	1413.68
	45"(1143mm)	42"(1067mm)	SYC -5042-L	■■■■	1102.21	1156.72	1548.80	1603.31
	51"(1295mm)	48"(1219mm)	SYC -5048-L	■■■■	1134.85	1194.70	1635.94	1695.79
	57"(1448mm)	54"(1372mm)	SYC -5054-L	■■■■	1167.49	1232.68	1723.08	1788.27
	63"(1600mm)	60"(1524mm)	SYC -5060-L	■■■■	1200.13	1270.66	1810.22	1880.75
	69"(1753mm)	66"(1676mm)	SYC -5066-L	■■■■	1232.77	1308.64	1897.36	1973.23
	75"(1905mm)	72"(1829mm)	SYC -5072-L	■■■■	1265.41	1346.62	1984.50	2065.71
	81"(2057mm)	78"(1981mm)	SYC -5078-L	■■■■	1298.05	1384.60	2071.64	2158.19
	87"(2210mm)	84"(2134mm)	SYC -5084-L	■■■■	1330.69	1422.58	2158.78	2250.67
	93"(2362mm)	90"(2286mm)	SYC -5090-L	■■■■	1363.33	1460.56	2245.92	2343.15
	99"(2515mm)	96"(2438mm)	SYC -5096-L	■■■■	1395.97	1498.54	2333.06	2435.63
	105"(2667mm)	102"(2591mm)	SYC -50A2-L	■■■■	1428.61	1536.52	2420.20	2528.11
	111"(2819mm)	108"(2743mm)	SYC -50A8-L	■■■■	1461.25	1574.50	2507.34	2620.59
	117"(2972mm)	114"(2896mm)	SYC -50B4-L	■■■■	1493.89	1612.48	2594.48	2713.07
Gallery Panels 58"(1473mm)H								
58"(1473mm)	21"(533mm)	18"(457mm)	SYC -5818-L	■■■■	\$ 781.22	\$ 824.53	\$ 1009.81	\$ 1053.12
	27"(686mm)	24"(610mm)	SYC -5824-L	■■■■	813.86	862.51	1096.95	1145.60
	33"(838mm)	30"(762mm)	SYC -5830-L	■■■■	846.50	900.49	1184.09	1238.08
	39"(991mm)	36"(914mm)	SYC -5836-L	■■■■	1034.58	1093.91	1426.67	1486.00
	45"(1143mm)	42"(1067mm)	SYC -5842-L	■■■■	1164.37	1229.04	1610.96	1675.63
	51"(1295mm)	48"(1219mm)	SYC -5848-L	■■■■	1197.01	1267.02	1698.10	1768.11
	57"(1448mm)	54"(1372mm)	SYC -5854-L	■■■■	1229.65	1305.00	1785.24	1860.59
	63"(1600mm)	60"(1524mm)	SYC -5860-L	■■■■	1262.29	1342.98	1872.38	1953.07

Gallery Panel to Compose Panel Intermediate T (Two-Sided Left/Right)

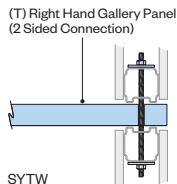
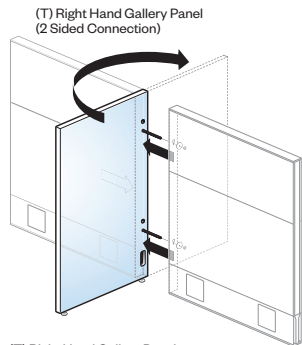
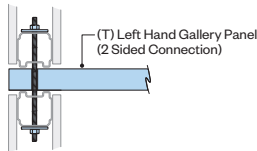
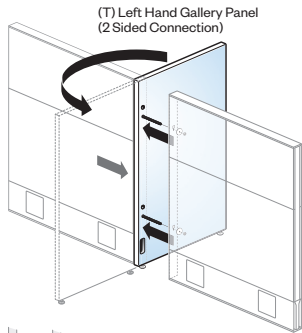

SYTW
SYTZ

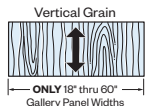
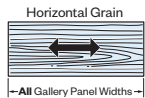

Class BC

Features

- Includes one pre-drilled, finished panel and attachment hardware.
- Gallery Panel is 1.18"(30mm) thick. Compose panel adds 3"(76mm) to width.
- High Pressure Laminate (HPL) panel has 1mm edgeband.
- Glides provide 1.5"(38mm) level adjustment.
- Panel and hardware are field installed.
- Rail for glass ready option standard in black.
- Handedness is determined by Face Connection.
- **Power pass through standard at the base.**

Specification Tips

- For intermediate use between two Compose panel frames. The two Compose panel frames must be the same height. Specify two Variable Height End-of-Run Trim or a Gallery Panel Variable Height In-Line Trim Post if the Gallery Panel is shorter than the two Compose panel frames.
- Not for use with Compose Glass Panels.
- Gallery Panels and Compose panel frames can be the same height, lower or taller than each other. Panel frame attachment heights on the Face of the Gallery Panel are available at 26"(660mm)H or 50"(1270mm)H:
 - If the Gallery Panel or panel frame are 42"(1067mm)H or lower, select W (26"(660mm)H) for mounting height.
 - If the Gallery Panel and panel frame are 50"(1270mm)H or higher select Z (50"(1270mm)H) for mounting height.
 - In conditions with Stack Frames, choose connection based on height of panel frame. **DO NOT MATCH HEIGHT OF STACK FRAME(S).**
- Gallery Panel has a handed face connection on both sides.
- Refer to the Specification Guide for Face and End mounting application guidelines.
- Base power applications require separately specified Flexible Power Connector - Corner Span, Work-height (VZEF-OBOQ-).
- Specify No Glass option when using Glass Topper Holder Kit.
- "No Glass" Gallery Panels option cannot be retrofit to Glass Ready Option.
- Separately specify:
 - Insert Glass for Glass-Ready Gallery Panels
 - Glass Topper Holder Kit

To Order, Specify:

1) Product number, including:

1 Face Connection Height

W 26"(660mm)H-42"(1067mm)H
Frame

Z 50"(1270mm)H or higher
Frame

2 Other End (Finished End or Connection End)

N No Connection (Finished End)

A 26"(660mm)H Connection

B 34"(864mm)H Connection

C 42"(1067mm)H Connection

D 50"(1270mm)H Connection

E 58"(1473mm)H Connection

3 Glass Options

N No Glass (Finished Top)

G Glass Ready

2) Laminate surface color.

3) Edgeband color.

Gallery Panel to Compose Panel Intermediate T (Two-Sided Left/Right)

Nominal Height	Actual Width	Nominal Width	Number		No Glass HPL		Glass Ready HPL	
			①	②③	A	B	A	B
Gallery Panels 26"(660mm)H-42"(1067mm)H								
26"(660mm)	21"(533mm)	18"(457mm)	SYTW-2618-LN		\$ 665.95	\$ 668.62	\$ 894.54	\$ 897.21
	27"(686mm)	24"(610mm)	SYTW-2624-LN		698.59	706.60	981.68	989.69
	33"(838mm)	30"(762mm)	SYTW-2630-LN		731.23	744.58	1068.82	1082.17
	39"(991mm)	36"(914mm)	SYTW-2636-LN		919.31	938.00	1311.40	1330.09
	45"(1143mm)	42"(1067mm)	SYTW-2642-LN		1049.10	1073.13	1495.69	1519.72
	51"(1295mm)	48"(1219mm)	SYTW-2648-LN		1081.74	1111.11	1582.83	1612.20
	57"(1448mm)	54"(1372mm)	SYTW-2654-LN		1114.38	1149.09	1669.97	1704.68
	63"(1600mm)	60"(1524mm)	SYTW-2660-LN		1147.02	1187.07	1757.11	1797.16
	69"(1753mm)	66"(1676mm)	SYTW-2666-LN		1179.66	1225.05	1844.25	1889.64
	75"(1905mm)	72"(1829mm)	SYTW-2672-LN		1212.30	1263.03	1931.39	1982.12
	81"(2057mm)	78"(1981mm)	SYTW-2678-LN		1244.94	1301.01	2018.53	2074.60
	87"(2210mm)	84"(2134mm)	SYTW-2684-LN		1277.58	1338.99	2105.67	2167.08
	93"(2362mm)	90"(2286mm)	SYTW-2690-LN		1310.22	1376.97	2192.81	2259.56
	99"(2515mm)	96"(2438mm)	SYTW-2696-LN		1342.86	1414.95	2279.95	2352.04
	105"(2667mm)	102"(2591mm)	SYTW-26A2-LN		1375.50	1452.93	2367.09	2444.52
	111"(2819mm)	108"(2743mm)	SYTW-26A8-LN		1408.14	1490.91	2454.23	2537.00
	117"(2972mm)	114"(2896mm)	SYTW-26B4-LN		1440.78	1528.89	2541.37	2629.48
27"(686mm)	21"(533mm)	18"(457mm)	SYTW-2718-LN		\$ 673.72	\$ 677.66	\$ 902.31	\$ 906.25
	27"(686mm)	24"(610mm)	SYTW-2724-LN		706.36	715.64	989.45	998.73
	33"(838mm)	30"(762mm)	SYTW-2730-LN		739.00	753.62	1076.59	1091.21
	39"(991mm)	36"(914mm)	SYTW-2736-LN		927.08	947.04	1319.17	1339.13
	45"(1143mm)	42"(1067mm)	SYTW-2742-LN		1056.87	1082.17	1503.46	1528.76
	51"(1295mm)	48"(1219mm)	SYTW-2748-LN		1089.51	1120.15	1590.60	1621.24
	57"(1448mm)	54"(1372mm)	SYTW-2754-LN		1122.15	1158.13	1677.74	1713.72
	63"(1600mm)	60"(1524mm)	SYTW-2760-LN		1154.79	1196.11	1764.88	1806.20
	69"(1753mm)	66"(1676mm)	SYTW-2766-LN		1187.43	1234.09	1852.02	1898.68
	75"(1905mm)	72"(1829mm)	SYTW-2772-LN		1220.07	1272.07	1939.16	1991.16
	81"(2057mm)	78"(1981mm)	SYTW-2778-LN		1252.71	1310.05	2026.30	2083.64
	87"(2210mm)	84"(2134mm)	SYTW-2784-LN		1285.35	1348.03	2113.44	2176.12
	93"(2362mm)	90"(2286mm)	SYTW-2790-LN		1317.99	1386.01	2200.58	2268.60
	99"(2515mm)	96"(2438mm)	SYTW-2796-LN		1350.63	1423.99	2287.72	2361.08
	105"(2667mm)	102"(2591mm)	SYTW-27A2-LN		1383.27	1461.97	2374.86	2453.56
	111"(2819mm)	108"(2743mm)	SYTW-27A8-LN		1415.91	1499.95	2462.00	2546.04
	117"(2972mm)	114"(2896mm)	SYTW-27B4-LN		1448.55	1537.93	2549.14	2638.52
34"(864mm)	21"(533mm)	18"(457mm)	SYTW-3418-LN		\$ 728.11	\$ 740.94	\$ 956.70	\$ 969.53
	27"(686mm)	24"(610mm)	SYTW-3424-LN		760.75	778.92	1043.84	1062.01
	33"(838mm)	30"(762mm)	SYTW-3430-LN		793.39	816.90	1130.98	1154.49
	39"(991mm)	36"(914mm)	SYTW-3436-LN		981.47	1010.32	1373.56	1402.41
	45"(1143mm)	42"(1067mm)	SYTW-3442-LN		1111.26	1145.45	1557.85	1592.04
	51"(1295mm)	48"(1219mm)	SYTW-3448-LN		1143.90	1183.43	1644.99	1684.52
	57"(1448mm)	54"(1372mm)	SYTW-3454-LN		1176.54	1221.41	1732.13	1777.00
	63"(1600mm)	60"(1524mm)	SYTW-3460-LN		1209.18	1259.39	1819.27	1869.48
	69"(1753mm)	66"(1676mm)	SYTW-3466-LN		1241.82	1297.37	1906.41	1961.96
	75"(1905mm)	72"(1829mm)	SYTW-3472-LN		1274.46	1335.35	1993.55	2054.44
	81"(2057mm)	78"(1981mm)	SYTW-3478-LN		1307.10	1373.33	2080.69	2146.92
	87"(2210mm)	84"(2134mm)	SYTW-3484-LN		1339.74	1411.31	2167.83	2239.40
	93"(2362mm)	90"(2286mm)	SYTW-3490-LN		1372.38	1449.29	2254.97	2331.88
	99"(2515mm)	96"(2438mm)	SYTW-3496-LN		1405.02	1487.27	2342.11	2424.36
	105"(2667mm)	102"(2591mm)	SYTW-34A2-LN		1437.66	1525.25	2429.25	2516.84
	111"(2819mm)	108"(2743mm)	SYTW-34A8-LN		1470.30	1563.23	2516.39	2609.32
	117"(2972mm)	114"(2896mm)	SYTW-34B4-LN		1502.94	1601.21	2603.53	2701.80

Gallery Panel to Compose Panel Intermediate T (Two-Sided Left/Right)

Nominal Height	Actual Width	Nominal Width	Number		No Glass HPL		Glass Ready HPL	
			①	②③	A	B	A	B
42"(1067mm)	21"(533mm)	18"(457mm)	SYTW-4218-LN		\$ 790.27	\$ 813.26	\$ 1018.86	\$ 1041.85
	27"(686mm)	24"(610mm)	SYTW-4224-LN		822.91	851.24	1106.00	1134.33
	33"(838mm)	30"(762mm)	SYTW-4230-LN		855.55	889.22	1193.14	1226.81
	39"(991mm)	36"(914mm)	SYTW-4236-LN		1043.63	1082.64	1435.72	1474.73
	45"(1143mm)	42"(1067mm)	SYTW-4242-LN		1173.42	1217.77	1620.01	1664.36
	51"(1295mm)	48"(1219mm)	SYTW-4248-LN		1206.06	1255.75	1707.15	1756.84
	57"(1448mm)	54"(1372mm)	SYTW-4254-LN		1238.70	1293.73	1794.29	1849.32
	63"(1600mm)	60"(1524mm)	SYTW-4260-LN		1271.34	1331.71	1881.43	1941.80
	69"(1753mm)	66"(1676mm)	SYTW-4266-LN		1303.98	1369.69	1968.57	2034.28
	75"(1905mm)	72"(1829mm)	SYTW-4272-LN		1336.62	1407.67	2055.71	2126.76
	81"(2057mm)	78"(1981mm)	SYTW-4278-LN		1369.26	1445.65	2142.85	2219.24
	87"(2210mm)	84"(2134mm)	SYTW-4284-LN		1401.90	1483.63	2229.99	2311.72
	93"(2362mm)	90"(2286mm)	SYTW-4290-LN		1434.54	1521.61	2317.13	2404.20
	99"(2515mm)	96"(2438mm)	SYTW-4296-LN		1467.18	1559.59	2404.27	2496.68
	105"(2667mm)	102"(2591mm)	SYTW-42A2-LN		1499.82	1597.57	2491.41	2589.16
	111"(2819mm)	108"(2743mm)	SYTW-42A8-LN		1532.46	1635.55	2578.55	2681.64
	117"(2972mm)	114"(2896mm)	SYTW-42B4-LN		1565.10	1673.53	2665.69	2774.12
Gallery Panels 50"(1270mm)H								
50"(1270mm)	21"(533mm)	18"(457mm)	SYT -5018-LN		\$ 852.43	\$ 885.58	\$ 1081.02	\$ 1114.17
	27"(686mm)	24"(610mm)	SYT -5024-LN		885.07	923.56	1168.16	1206.65
	33"(838mm)	30"(762mm)	SYT -5030-LN		917.71	961.54	1255.30	1299.13
	39"(991mm)	36"(914mm)	SYT -5036-LN		1105.79	1154.96	1497.88	1547.05
	45"(1143mm)	42"(1067mm)	SYT -5042-LN		1235.58	1290.09	1682.17	1736.68
	51"(1295mm)	48"(1219mm)	SYT -5048-LN		1268.22	1328.07	1769.31	1829.16
	57"(1448mm)	54"(1372mm)	SYT -5054-LN		1300.86	1366.05	1856.45	1921.64
	63"(1600mm)	60"(1524mm)	SYT -5060-LN		1333.50	1404.03	1943.59	2014.12
	69"(1753mm)	66"(1676mm)	SYT -5066-LN		1366.14	1442.01	2030.73	2106.60
	75"(1905mm)	72"(1829mm)	SYT -5072-LN		1398.78	1479.99	2117.87	2199.08
	81"(2057mm)	78"(1981mm)	SYT -5078-LN		1431.42	1517.97	2205.01	2291.56
	87"(2210mm)	84"(2134mm)	SYT -5084-LN		1464.06	1555.95	2292.15	2384.04
	93"(2362mm)	90"(2286mm)	SYT -5090-LN		1496.70	1593.93	2379.29	2476.52
	99"(2515mm)	96"(2438mm)	SYT -5096-LN		1529.34	1631.91	2466.43	2569.00
	105"(2667mm)	102"(2591mm)	SYT -50A2-LN		1561.98	1669.89	2553.57	2661.48
	111"(2819mm)	108"(2743mm)	SYT -50A8-LN		1594.62	1707.87	2640.71	2753.96
	117"(2972mm)	114"(2896mm)	SYT -50B4-LN		1627.26	1745.85	2727.85	2846.44
Gallery Panels 58"(1473mm)H								
58"(1473mm)	21"(533mm)	18"(457mm)	SYT -5818-LN		\$ 914.59	\$ 957.90	\$ 1143.18	\$ 1186.49
	27"(686mm)	24"(610mm)	SYT -5824-LN		947.23	995.88	1230.32	1278.97
	33"(838mm)	30"(762mm)	SYT -5830-LN		979.87	1033.86	1317.46	1371.45
	39"(991mm)	36"(914mm)	SYT -5836-LN		1167.95	1227.28	1560.04	1619.37
	45"(1143mm)	42"(1067mm)	SYT -5842-LN		1297.74	1362.41	1744.33	1809.00
	51"(1295mm)	48"(1219mm)	SYT -5848-LN		1330.38	1400.39	1831.47	1901.48
	57"(1448mm)	54"(1372mm)	SYT -5854-LN		1363.02	1438.37	1918.61	1993.96
	63"(1600mm)	60"(1524mm)	SYT -5860-LN		1395.66	1476.35	2005.75	2086.44

Gallery Panel to Compose Panel Intermediate H (Two-Sided Half Left/Right)

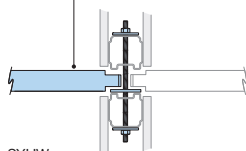
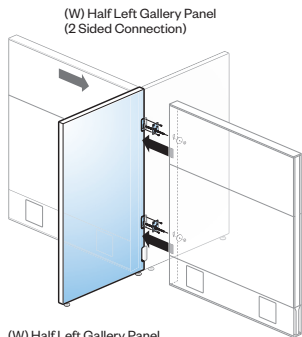
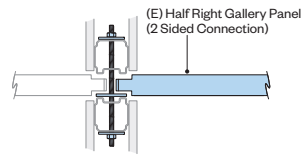
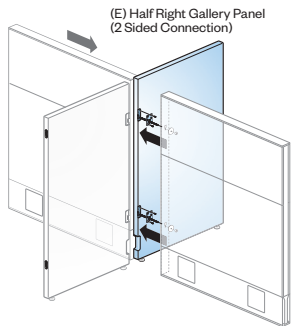

SYHW
SYHZ

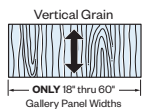
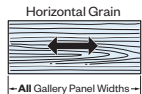

Class BC

Features

- Includes one pre-drilled, finished panel and attachment hardware.
- Attachment hardware includes two flat brackets to install on one side of the Gallery Panel.
- Gallery Panel is 1.18"(30mm) thick. Half Compose panel adds 1.5"(38mm) to width.
- High Pressure Laminate (HPL) panel has 1mm edgeband.
- Glides provide 1.5"(38mm) level adjustment.
- Panel and hardware are field installed.
- Rail for glass ready option standard in black.
- Power pass through standard at the base.

Specification Tips

- Two (H) Half Intermediate Gallery Panels are required for this application. Gallery Panel heights must match, widths may be different.
- For intermediate use between two Compose panel frames. The two Compose panel frames must be the same height. Specify two Variable Height End-of-Run Trim or a Gallery Panel Variable Height In-Line Trim Post if the Gallery Panel is shorter than the two panel frames.
- Not for use with Compose Glass Panels.
- Gallery Panels and Compose panel frames can be the same height, lower or taller than each other. Panel frame attachment heights on the Face of the Gallery Panel are available at 26"(660mm)H or 50"(1270mm)H:
 - If the Gallery Panel or panel frame are 42"(1067mm)H or lower, select W (26"(660mm)H) for mounting height.
 - If the Gallery Panel and panel frame are 50"(1270mm)H or higher select Z (50"(1270mm)H) for mounting height.
 - In conditions with Stack Frames, choose connection based on height of panel frame. **DO NOT MATCH HEIGHT OF STACK FRAME(S).**
- Gallery Panel has a handed face connection on both sides.
- Refer to the Specification Guide for Face and End mounting application guidelines.
- Base power applications require separately specified Flexible Power Connector - Corner Span, Work-height (VZEF-OBOQ-).
- Specify No Glass option when using Glass Topper Holder Kit.
- "No Glass" Gallery Panels option cannot be retrofit to Glass Ready Option.
- Separately specify:
 - Insert Glass for Glass-Ready Gallery Panels
 - Glass Topper Holder Kit

To Order, Specify:

1) Product number, including:

1 Face Connection Height for Both Faces

W 26"(660mm)H-42"(1067mm)H Frame

Z 50"(1270mm)H or higher Frame

2 Other End (Finished End or Connection End)

N No Connection (Finished End)

A 26"(660mm)H Connection

B 34"(864mm)H Connection

C 42"(1067mm)H Connection

D 50"(1270mm)H Connection

E 58"(1473mm)H Connection

3 Glass Options

N No Glass (Finished Top)

G Glass Ready

2) Laminate surface color.

3) Edgeband color.

Gallery Panel to Compose Panel Intermediate H (Two-Sided Half Left/Right)

Nominal Height	Actual Width	Nominal Width	Number		No Glass HPL		Glass Ready HPL	
			①	②③	A	B	A	B
Gallery Panels 26"(660mm)H-42"(1067mm)H								
26"(660mm)	19.5"(495mm)	18"(457mm)	SYHW-2618-LN		\$ 665.95	\$ 668.62	\$ 894.54	\$ 897.21
	25.5"(648mm)	24"(610mm)	SYHW-2624-LN		698.59	706.60	981.68	989.69
	31.5"(800mm)	30"(762mm)	SYHW-2630-LN		731.23	744.58	1068.82	1082.17
	37.5"(953mm)	36"(914mm)	SYHW-2636-LN		919.31	938.00	1311.40	1330.09
	43.5"(1105mm)	42"(1067mm)	SYHW-2642-LN		1049.10	1073.13	1495.69	1519.72
	49.5"(1257mm)	48"(1219mm)	SYHW-2648-LN		1081.74	1111.11	1582.83	1612.20
	55.5"(1410mm)	54"(1372mm)	SYHW-2654-LN		1114.38	1149.09	1669.97	1704.68
	61.5"(1562mm)	60"(1524mm)	SYHW-2660-LN		1147.02	1187.07	1757.11	1797.16
	67.5"(1715mm)	66"(1676mm)	SYHW-2666-LN		1179.66	1225.05	1844.25	1889.64
	73.5"(1867mm)	72"(1829mm)	SYHW-2672-LN		1212.30	1263.03	1931.39	1982.12
	79.5"(2019mm)	78"(1981mm)	SYHW-2678-LN		1244.94	1301.01	2018.53	2074.60
	85.5"(2172mm)	84"(2134mm)	SYHW-2684-LN		1277.58	1338.99	2105.67	2167.08
	91.5"(2324mm)	90"(2286mm)	SYHW-2690-LN		1310.22	1376.97	2192.81	2259.56
	97.5"(2477mm)	96"(2438mm)	SYHW-2696-LN		1342.86	1414.95	2279.95	2352.04
	103.5"(2629mm)	102"(2591mm)	SYHW-26A2-LN		1375.50	1452.93	2367.09	2444.52
	109.5"(2781mm)	108"(2743mm)	SYHW-26A8-LN		1408.14	1490.91	2454.23	2537.00
	115.5"(2934mm)	114"(2896mm)	SYHW-26B4-LN		1440.78	1528.89	2541.37	2629.48
27"(686mm)	19.5"(495mm)	18"(457mm)	SYHW-2718-LN		\$ 673.72	\$ 677.66	\$ 902.31	\$ 906.25
	25.5"(648mm)	24"(610mm)	SYHW-2724-LN		706.36	715.64	989.45	998.73
	31.5"(800mm)	30"(762mm)	SYHW-2730-LN		739.00	753.62	1076.59	1091.21
	37.5"(953mm)	36"(914mm)	SYHW-2736-LN		927.08	947.04	1319.17	1339.13
	43.5"(1105mm)	42"(1067mm)	SYHW-2742-LN		1056.87	1082.17	1503.46	1528.76
	49.5"(1257mm)	48"(1219mm)	SYHW-2748-LN		1089.51	1120.15	1590.60	1621.24
	55.5"(1410mm)	54"(1372mm)	SYHW-2754-LN		1122.15	1158.13	1677.74	1713.72
	61.5"(1562mm)	60"(1524mm)	SYHW-2760-LN		1154.79	1196.11	1764.88	1806.20
	67.5"(1715mm)	66"(1676mm)	SYHW-2766-LN		1187.43	1234.09	1852.02	1898.68
	73.5"(1867mm)	72"(1829mm)	SYHW-2772-LN		1220.07	1272.07	1939.16	1991.16
	79.5"(2019mm)	78"(1981mm)	SYHW-2778-LN		1252.71	1310.05	2026.30	2083.64
	85.5"(2172mm)	84"(2134mm)	SYHW-2784-LN		1285.35	1348.03	2113.44	2176.12
	91.5"(2324mm)	90"(2286mm)	SYHW-2790-LN		1317.99	1386.01	2200.58	2268.60
	97.5"(2477mm)	96"(2438mm)	SYHW-2796-LN		1350.63	1423.99	2287.72	2361.08
	103.5"(2629mm)	102"(2591mm)	SYHW-27A2-LN		1383.27	1461.97	2374.86	2453.56
	109.5"(2781mm)	108"(2743mm)	SYHW-27A8-LN		1415.91	1499.95	2462.00	2546.04
	115.5"(2934mm)	114"(2896mm)	SYHW-27B4-LN		1448.55	1537.93	2549.14	2638.52
34"(864mm)	19.5"(495mm)	18"(457mm)	SYHW-3418-LN		\$ 728.11	\$ 740.94	\$ 956.70	\$ 969.53
	25.5"(648mm)	24"(610mm)	SYHW-3424-LN		760.75	778.92	1043.84	1062.01
	31.5"(800mm)	30"(762mm)	SYHW-3430-LN		793.39	816.90	1130.98	1154.49
	37.5"(953mm)	36"(914mm)	SYHW-3436-LN		981.47	1010.32	1373.56	1402.41
	43.5"(1105mm)	42"(1067mm)	SYHW-3442-LN		1111.26	1145.45	1557.85	1592.04
	49.5"(1257mm)	48"(1219mm)	SYHW-3448-LN		1143.90	1183.43	1644.99	1684.52
	55.5"(1410mm)	54"(1372mm)	SYHW-3454-LN		1176.54	1221.41	1732.13	1777.00
	61.5"(1562mm)	60"(1524mm)	SYHW-3460-LN		1209.18	1259.39	1819.27	1869.48
	67.5"(1715mm)	66"(1676mm)	SYHW-3466-LN		1241.82	1297.37	1906.41	1961.96
	73.5"(1867mm)	72"(1829mm)	SYHW-3472-LN		1274.46	1335.35	1993.55	2054.44
	79.5"(2019mm)	78"(1981mm)	SYHW-3478-LN		1307.10	1373.33	2080.69	2146.92
	85.5"(2172mm)	84"(2134mm)	SYHW-3484-LN		1339.74	1411.31	2167.83	2239.40
	91.5"(2324mm)	90"(2286mm)	SYHW-3490-LN		1372.38	1449.29	2254.97	2331.88
	97.5"(2477mm)	96"(2438mm)	SYHW-3496-LN		1405.02	1487.27	2342.11	2424.36
	103.5"(2629mm)	102"(2591mm)	SYHW-34A2-LN		1437.66	1525.25	2429.25	2516.84
	109.5"(2781mm)	108"(2743mm)	SYHW-34A8-LN		1470.30	1563.23	2516.39	2609.32
	115.5"(2934mm)	114"(2896mm)	SYHW-34B4-LN		1502.94	1601.21	2603.53	2701.80

Gallery Panel to Compose Panel Intermediate H (Two-Sided Half Left/Right)

Nominal Height	Actual Width	Nominal Width	Number		No Glass HPL		Glass Ready HPL	
			①	②③	A	B	A	B
42"(1067mm)	19.5"(495mm)	18"(457mm)	SYHW-4218-LN		\$ 790.27	\$ 813.26	\$ 1018.86	\$ 1041.85
	25.5"(648mm)	24"(610mm)	SYHW-4224-LN		822.91	851.24	1106.00	1134.33
	31.5"(800mm)	30"(762mm)	SYHW-4230-LN		855.55	889.22	1193.14	1226.81
	37.5"(953mm)	36"(914mm)	SYHW-4236-LN		1043.63	1082.64	1435.72	1474.73
	43.5"(1105mm)	42"(1067mm)	SYHW-4242-LN		1173.42	1217.77	1620.01	1664.36
	49.5"(1257mm)	48"(1219mm)	SYHW-4248-LN		1206.06	1255.75	1707.15	1756.84
	55.5"(1410mm)	54"(1372mm)	SYHW-4254-LN		1238.70	1293.73	1794.29	1849.32
	61.5"(1562mm)	60"(1524mm)	SYHW-4260-LN		1271.34	1331.71	1881.43	1941.80
	67.5"(1715mm)	66"(1676mm)	SYHW-4266-LN		1303.98	1369.69	1968.57	2034.28
	73.5"(1867mm)	72"(1829mm)	SYHW-4272-LN		1336.62	1407.67	2055.71	2126.76
	79.5"(2019mm)	78"(1981mm)	SYHW-4278-LN		1369.26	1445.65	2142.85	2219.24
	85.5"(2172mm)	84"(2134mm)	SYHW-4284-LN		1401.90	1483.63	2229.99	2311.72
	91.5"(2324mm)	90"(2286mm)	SYHW-4290-LN		1434.54	1521.61	2317.13	2404.20
	97.5"(2477mm)	96"(2438mm)	SYHW-4296-LN		1467.18	1559.59	2404.27	2496.68
	103.5"(2629mm)	102"(2591mm)	SYHW-42A2-LN		1499.82	1597.57	2491.41	2589.16
	109.5"(2781mm)	108"(2743mm)	SYHW-42A8-LN		1532.46	1635.55	2578.55	2681.64
	115.5"(2934mm)	114"(2896mm)	SYHW-42B4-LN		1565.10	1673.53	2665.69	2774.12
Gallery Panels 50"(1270mm)H								
50"(1270mm)	19.5"(495mm)	18"(457mm)	SYH -5018-LN		\$ 852.43	\$ 885.58	\$ 1081.02	\$ 1114.17
	25.5"(648mm)	24"(610mm)	SYH -5024-LN		885.07	923.56	1168.16	1206.65
	31.5"(800mm)	30"(762mm)	SYH -5030-LN		917.71	961.54	1255.30	1299.13
	37.5"(953mm)	36"(914mm)	SYH -5036-LN		1105.79	1154.96	1497.88	1547.05
	43.5"(1105mm)	42"(1067mm)	SYH -5042-LN		1235.58	1290.09	1682.17	1736.68
	49.5"(1257mm)	48"(1219mm)	SYH -5048-LN		1268.22	1328.07	1769.31	1829.16
	55.5"(1410mm)	54"(1372mm)	SYH -5054-LN		1300.86	1366.05	1856.45	1921.64
	61.5"(1562mm)	60"(1524mm)	SYH -5060-LN		1333.50	1404.03	1943.59	2014.12
	67.5"(1715mm)	66"(1676mm)	SYH -5066-LN		1366.14	1442.01	2030.73	2106.60
	73.5"(1867mm)	72"(1829mm)	SYH -5072-LN		1398.78	1479.99	2117.87	2199.08
	79.5"(2019mm)	78"(1981mm)	SYH -5078-LN		1431.42	1517.97	2205.01	2291.56
	85.5"(2172mm)	84"(2134mm)	SYH -5084-LN		1464.06	1555.95	2292.15	2384.04
	91.5"(2324mm)	90"(2286mm)	SYH -5090-LN		1496.70	1593.93	2379.29	2476.52
	97.5"(2477mm)	96"(2438mm)	SYH -5096-LN		1529.34	1631.91	2466.43	2569.00
	103.5"(2629mm)	102"(2591mm)	SYH -50A2-LN		1561.98	1669.89	2553.57	2661.48
	109.5"(2781mm)	108"(2743mm)	SYH -50A8-LN		1594.62	1707.87	2640.71	2753.96
	115.5"(2934mm)	114"(2896mm)	SYH -50B4-LN		1627.26	1745.85	2727.85	2846.44
Gallery Panels 58"(1473mm)H								
58"(1473mm)	19.5"(495mm)	18"(457mm)	SYH -5818-LN		\$ 914.59	\$ 957.90	\$ 1143.18	\$ 1186.49
	25.5"(648mm)	24"(610mm)	SYH -5824-LN		947.23	995.88	1230.32	1278.97
	31.5"(800mm)	30"(762mm)	SYH -5830-LN		979.87	1033.86	1317.46	1371.45
	37.5"(953mm)	36"(914mm)	SYH -5836-LN		1167.95	1227.28	1560.04	1619.37
	43.5"(1105mm)	42"(1067mm)	SYH -5842-LN		1297.74	1362.41	1744.33	1809.00
	49.5"(1257mm)	48"(1219mm)	SYH -5848-LN		1330.38	1400.39	1831.47	1901.48
	55.5"(1410mm)	54"(1372mm)	SYH -5854-LN		1363.02	1438.37	1918.61	1993.96
	61.5"(1562mm)	60"(1524mm)	SYH -5860-LN		1395.66	1476.35	2005.75	2086.44

Gallery Panel to Compose Panel Intermediate X (Center - Two Sided Mount)

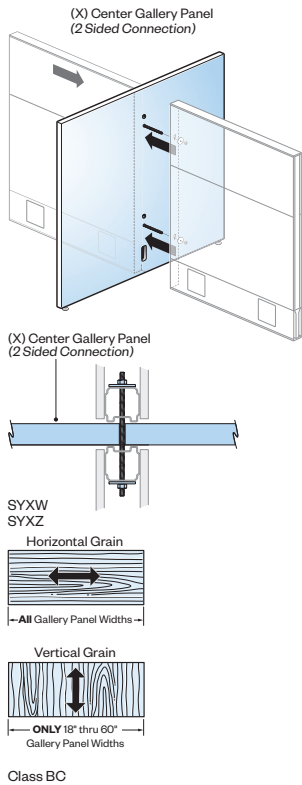

Class BC

Features

- Includes one pre-drilled, finished panel and attachment hardware.
- Gallery Panel is 1.18" (30mm) thick. Compose panel adds 3" (76mm) to width.
- High Pressure Laminate (HPL) panel has 1mm edgeband.
- Glides provide 1.5" (38mm) level adjustment.
- Panel and hardware are field installed.
- Rail for glass ready option standard in black.
- **Power pass through standard at the base.**

Specification Tips

- For intermediate use between two Compose panel frames. The two panel frames must be the same height. Specify two Variable Height End-of-Run Trim or a Gallery Panel Variable Height In-Line Trim Post if the Gallery Panel is shorter than the two panel frames.
- Not for use with Compose Glass Panels.
- Gallery Panels and Compose panel frames can be the same height, lower or taller than each other. Compose panel frame attachment heights on the Face of the Gallery Panel are available at 26" (660mm)H or 50" (1270mm)H:
 - If the Gallery Panel or panel frame are 42" (1067mm)H or lower, select W (26" (660mm)H) for mounting height.
 - If the Gallery Panel and panel frame are 50" (1270mm)H or higher select Z (50" (1270mm)H) for mounting height.
 - In conditions with Stack Frames, choose connection based on height of panel frame. **DO NOT MATCH HEIGHT OF STACK FRAME(S).**
- Gallery Panel has a center face connection on both sides.
- Refer to the Specification Guide for Face and End mounting application guidelines.
- Base power applications require separately specified Flexible Power Connector - Corner Span, Work-height (VZEF-0B0Q-).
- Specify No Glass option when using Glass Topper Holder Kit.
- "No Glass" Gallery Panels option cannot be retrofit to Glass Ready Option.
- Separately specify:
 - Insert Glass for Glass-Ready Gallery Panels
 - Glass Topper Holder Kit

To Order, Specify:

1) Product number, including:

1 Face Connection Height for Both Faces

W 26" (660mm)H-42" (1067mm)H Frame

Z 50" (1270mm)H or higher Frame

2 First End (Finished End or Connection End)

N No Connection (Finished End)

A 26" (660mm)H Connection

B 34" (864mm)H Connection

C 42" (1067mm)H Connection

D 50" (1270mm)H Connection

E 58" (1473mm)H Connection

3 Other End (Finished End or Connection End)

N No Connection (Finished End)

A 26" (660mm)H Connection

B 34" (864mm)H Connection

C 42" (1067mm)H Connection

D 50" (1270mm)H Connection

E 58" (1473mm)H Connection

4 Glass Options

N No Glass (Finished Top)

G Glass Ready

2) Laminate surface color.

3) Edgeband color.

Gallery Panel to Compose Panel Intermediate X (Center - Two Sided Mount)

Nominal Height	Actual Width	Nominal Width	Number			No Glass HPL		Glass Ready HPL	
			①	②③④		A	B	A	B
Gallery Panels 26"(660mm)H-42"(1067mm)H									
26"(660mm)	21"(533mm)	18"(457mm)	SYXW-2618-L	■ ■ ■ ■		\$ 665.95	\$ 668.62	\$ 894.54	\$ 897.21
	27"(686mm)	24"(610mm)	SYXW-2624-L	■ ■ ■ ■		698.59	706.60	981.68	989.69
	33"(838mm)	30"(762mm)	SYXW-2630-L	■ ■ ■ ■		731.23	744.58	1068.82	1082.17
	39"(991mm)	36"(914mm)	SYXW-2636-L	■ ■ ■ ■		919.31	938.00	1311.40	1330.09
	45"(1143mm)	42"(1067mm)	SYXW-2642-L	■ ■ ■ ■		1049.10	1073.13	1495.69	1519.72
	51"(1295mm)	48"(1219mm)	SYXW-2648-L	■ ■ ■ ■		1081.74	1111.11	1582.83	1612.20
	57"(1448mm)	54"(1372mm)	SYXW-2654-L	■ ■ ■ ■		1114.38	1149.09	1669.97	1704.68
	63"(1600mm)	60"(1524mm)	SYXW-2660-L	■ ■ ■ ■		1147.02	1187.07	1757.11	1797.16
	69"(1753mm)	66"(1676mm)	SYXW-2666-L	■ ■ ■ ■		1179.66	1225.05	1844.25	1889.64
	75"(1905mm)	72"(1829mm)	SYXW-2672-L	■ ■ ■ ■		1212.30	1263.03	1931.39	1982.12
	81"(2057mm)	78"(1981mm)	SYXW-2678-L	■ ■ ■ ■		1244.94	1301.01	2018.53	2074.60
	87"(2210mm)	84"(2134mm)	SYXW-2684-L	■ ■ ■ ■		1277.58	1338.99	2105.67	2167.08
	93"(2362mm)	90"(2286mm)	SYXW-2690-L	■ ■ ■ ■		1310.22	1376.97	2192.81	2259.56
	99"(2515mm)	96"(2438mm)	SYXW-2696-L	■ ■ ■ ■		1342.86	1414.95	2279.95	2352.04
	105"(2667mm)	102"(2591mm)	SYXW-26A2-L	■ ■ ■ ■		1375.50	1452.93	2367.09	2444.52
	111"(2819mm)	108"(2743mm)	SYXW-26A8-L	■ ■ ■ ■		1408.14	1490.91	2454.23	2537.00
	117"(2972mm)	114"(2896mm)	SYXW-26B4-L	■ ■ ■ ■		1440.78	1528.89	2541.37	2629.48
27"(686mm)	21"(533mm)	18"(457mm)	SYXW-2718-L	■ ■ ■ ■		\$ 673.72	\$ 677.66	\$ 902.31	\$ 906.25
	27"(686mm)	24"(610mm)	SYXW-2724-L	■ ■ ■ ■		706.36	715.64	989.45	998.73
	33"(838mm)	30"(762mm)	SYXW-2730-L	■ ■ ■ ■		739.00	753.62	1076.59	1091.21
	39"(991mm)	36"(914mm)	SYXW-2736-L	■ ■ ■ ■		927.08	947.04	1319.17	1339.13
	45"(1143mm)	42"(1067mm)	SYXW-2742-L	■ ■ ■ ■		1056.87	1082.17	1503.46	1528.76
	51"(1295mm)	48"(1219mm)	SYXW-2748-L	■ ■ ■ ■		1089.51	1120.15	1590.60	1621.24
	57"(1448mm)	54"(1372mm)	SYXW-2754-L	■ ■ ■ ■		1122.15	1158.13	1677.74	1713.72
	63"(1600mm)	60"(1524mm)	SYXW-2760-L	■ ■ ■ ■		1154.79	1196.11	1764.88	1806.20
	69"(1753mm)	66"(1676mm)	SYXW-2766-L	■ ■ ■ ■		1187.43	1234.09	1852.02	1898.68
	75"(1905mm)	72"(1829mm)	SYXW-2772-L	■ ■ ■ ■		1220.07	1272.07	1939.16	1991.16
	81"(2057mm)	78"(1981mm)	SYXW-2778-L	■ ■ ■ ■		1252.71	1310.05	2026.30	2083.64
	87"(2210mm)	84"(2134mm)	SYXW-2784-L	■ ■ ■ ■		1285.35	1348.03	2113.44	2176.12
	93"(2362mm)	90"(2286mm)	SYXW-2790-L	■ ■ ■ ■		1317.99	1386.01	2200.58	2268.60
	99"(2515mm)	96"(2438mm)	SYXW-2796-L	■ ■ ■ ■		1350.63	1423.99	2287.72	2361.08
	105"(2667mm)	102"(2591mm)	SYXW-27A2-L	■ ■ ■ ■		1383.27	1461.97	2374.86	2453.56
	111"(2819mm)	108"(2743mm)	SYXW-27A8-L	■ ■ ■ ■		1415.91	1499.95	2462.00	2546.04
	117"(2972mm)	114"(2896mm)	SYXW-27B4-L	■ ■ ■ ■		1448.55	1537.93	2549.14	2638.52
34"(864mm)	21"(533mm)	18"(457mm)	SYXW-3418-L	■ ■ ■ ■		\$ 728.11	\$ 740.94	\$ 956.70	\$ 969.53
	27"(686mm)	24"(610mm)	SYXW-3424-L	■ ■ ■ ■		760.75	778.92	1043.84	1062.01
	33"(838mm)	30"(762mm)	SYXW-3430-L	■ ■ ■ ■		793.39	816.90	1130.98	1154.49
	39"(991mm)	36"(914mm)	SYXW-3436-L	■ ■ ■ ■		981.47	1010.32	1373.56	1402.41
	45"(1143mm)	42"(1067mm)	SYXW-3442-L	■ ■ ■ ■		1111.26	1145.45	1557.85	1592.04
	51"(1295mm)	48"(1219mm)	SYXW-3448-L	■ ■ ■ ■		1143.90	1183.43	1644.99	1684.52
	57"(1448mm)	54"(1372mm)	SYXW-3454-L	■ ■ ■ ■		1176.54	1221.41	1732.13	1777.00
	63"(1600mm)	60"(1524mm)	SYXW-3460-L	■ ■ ■ ■		1209.18	1259.39	1819.27	1869.48
	69"(1753mm)	66"(1676mm)	SYXW-3466-L	■ ■ ■ ■		1241.82	1297.37	1906.41	1961.96
	75"(1905mm)	72"(1829mm)	SYXW-3472-L	■ ■ ■ ■		1274.46	1335.35	1993.55	2054.44
	81"(2057mm)	78"(1981mm)	SYXW-3478-L	■ ■ ■ ■		1307.10	1373.33	2080.69	2146.92
	87"(2210mm)	84"(2134mm)	SYXW-3484-L	■ ■ ■ ■		1339.74	1411.31	2167.83	2239.40
	93"(2362mm)	90"(2286mm)	SYXW-3490-L	■ ■ ■ ■		1372.38	1449.29	2254.97	2331.88
	99"(2515mm)	96"(2438mm)	SYXW-3496-L	■ ■ ■ ■		1405.02	1487.27	2342.11	2424.36
	105"(2667mm)	102"(2591mm)	SYXW-34A2-L	■ ■ ■ ■		1437.66	1525.25	2429.25	2516.84
	111"(2819mm)	108"(2743mm)	SYXW-34A8-L	■ ■ ■ ■		1470.30	1563.23	2516.39	2609.32
	117"(2972mm)	114"(2896mm)	SYXW-34B4-L	■ ■ ■ ■		1502.94	1601.21	2603.53	2701.80

Gallery Panel to Compose Panel Intermediate X (Center - Two Sided Mount)

Nominal Height	Actual Width	Nominal Width	Number	No Glass HPL		Glass Ready HPL		
				A	B	A	B	
42"(1067mm)	21"(533mm)	18"(457mm)	SYXW-4218-L	█ █ █ █	\$ 790.27	\$ 813.26	\$ 1018.86	\$ 1041.85
	27"(686mm)	24"(610mm)	SYXW-4224-L	█ █ █ █	822.91	851.24	1106.00	1134.33
	33"(838mm)	30"(762mm)	SYXW-4230-L	█ █ █ █	855.55	889.22	1193.14	1226.81
	39"(991mm)	36"(914mm)	SYXW-4236-L	█ █ █ █	1043.63	1082.64	1435.72	1474.73
	45"(1143mm)	42"(1067mm)	SYXW-4242-L	█ █ █ █	1173.42	1217.77	1620.01	1664.36
	51"(1295mm)	48"(1219mm)	SYXW-4248-L	█ █ █ █	1206.06	1255.75	1707.15	1756.84
	57"(1448mm)	54"(1372mm)	SYXW-4254-L	█ █ █ █	1238.70	1293.73	1794.29	1849.32
	63"(1600mm)	60"(1524mm)	SYXW-4260-L	█ █ █ █	1271.34	1331.71	1881.43	1941.80
	69"(1753mm)	66"(1676mm)	SYXW-4266-L	█ █ █ █	1303.98	1369.69	1968.57	2034.28
	75"(1905mm)	72"(1829mm)	SYXW-4272-L	█ █ █ █	1336.62	1407.67	2055.71	2126.76
	81"(2057mm)	78"(1981mm)	SYXW-4278-L	█ █ █ █	1369.26	1445.65	2142.85	2219.24
	87"(2210mm)	84"(2134mm)	SYXW-4284-L	█ █ █ █	1401.90	1483.63	2229.99	2311.72
	93"(2362mm)	90"(2286mm)	SYXW-4290-L	█ █ █ █	1434.54	1521.61	2317.13	2404.20
	99"(2515mm)	96"(2438mm)	SYXW-4296-L	█ █ █ █	1467.18	1559.59	2404.27	2496.68
	105"(2667mm)	102"(2591mm)	SYXW-42A2-L	█ █ █ █	1499.82	1597.57	2491.41	2589.16
	111"(2819mm)	108"(2743mm)	SYXW-42A8-L	█ █ █ █	1532.46	1635.55	2578.55	2681.64
117"(2972mm)	114"(2896mm)	SYXW-42B4-L	█ █ █ █	1565.10	1673.53	2665.69	2774.12	
Gallery Panels 50"(1270mm)H								
50"(1270mm)	21"(533mm)	18"(457mm)	SYX -5018-L	█ █ █ █	\$ 852.43	\$ 885.58	\$ 1081.02	\$ 1114.17
	27"(686mm)	24"(610mm)	SYX -5024-L	█ █ █ █	885.07	923.56	1168.16	1206.65
	33"(838mm)	30"(762mm)	SYX -5030-L	█ █ █ █	917.71	961.54	1255.30	1299.13
	39"(991mm)	36"(914mm)	SYX -5036-L	█ █ █ █	1105.79	1154.96	1497.88	1547.05
	45"(1143mm)	42"(1067mm)	SYX -5042-L	█ █ █ █	1235.58	1290.09	1682.17	1736.68
	51"(1295mm)	48"(1219mm)	SYX -5048-L	█ █ █ █	1268.22	1328.07	1769.31	1829.16
	57"(1448mm)	54"(1372mm)	SYX -5054-L	█ █ █ █	1300.86	1366.05	1856.45	1921.64
	63"(1600mm)	60"(1524mm)	SYX -5060-L	█ █ █ █	1333.50	1404.03	1943.59	2014.12
	69"(1753mm)	66"(1676mm)	SYX -5066-L	█ █ █ █	1366.14	1442.01	2030.73	2106.60
	75"(1905mm)	72"(1829mm)	SYX -5072-L	█ █ █ █	1398.78	1479.99	2117.87	2199.08
	81"(2057mm)	78"(1981mm)	SYX -5078-L	█ █ █ █	1431.42	1517.97	2205.01	2291.56
	87"(2210mm)	84"(2134mm)	SYX -5084-L	█ █ █ █	1464.06	1555.95	2292.15	2384.04
	93"(2362mm)	90"(2286mm)	SYX -5090-L	█ █ █ █	1496.70	1593.93	2379.29	2476.52
	99"(2515mm)	96"(2438mm)	SYX -5096-L	█ █ █ █	1529.34	1631.91	2466.43	2569.00
	105"(2667mm)	102"(2591mm)	SYX -50A2-L	█ █ █ █	1561.98	1669.89	2553.57	2661.48
	111"(2819mm)	108"(2743mm)	SYX -50A8-L	█ █ █ █	1594.62	1707.87	2640.71	2753.96
117"(2972mm)	114"(2896mm)	SYX -50B4-L	█ █ █ █	1627.26	1745.85	2727.85	2846.44	
Gallery Panels 58"(1473mm)H								
58"(1473mm)	21"(533mm)	18"(457mm)	SYX -5818-L	█ █ █ █	\$ 914.59	\$ 957.90	\$ 1143.18	\$ 1186.49
	27"(686mm)	24"(610mm)	SYX -5824-L	█ █ █ █	947.23	995.88	1230.32	1278.97
	33"(838mm)	30"(762mm)	SYX -5830-L	█ █ █ █	979.87	1033.86	1317.46	1371.45
	39"(991mm)	36"(914mm)	SYX -5836-L	█ █ █ █	1167.95	1227.28	1560.04	1619.37
	45"(1143mm)	42"(1067mm)	SYX -5842-L	█ █ █ █	1297.74	1362.41	1744.33	1809.00
	51"(1295mm)	48"(1219mm)	SYX -5848-L	█ █ █ █	1330.38	1400.39	1831.47	1901.48
	57"(1448mm)	54"(1372mm)	SYX -5854-L	█ █ █ █	1363.02	1438.37	1918.61	1993.96
	63"(1600mm)	60"(1524mm)	SYX -5860-L	█ █ █ █	1395.66	1476.35	2005.75	2086.44

Gallery Panel to Compose Beam End-of-Run

L/R (Left or Right Mount)

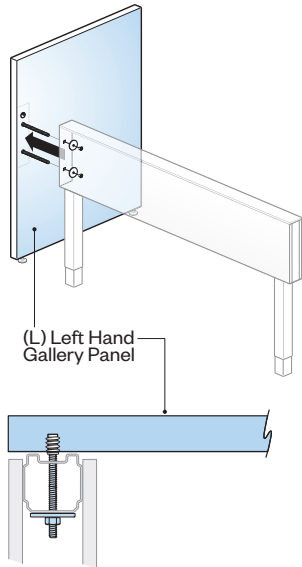

SYLJ (Left Face)

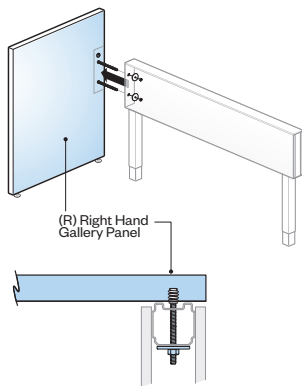

SYRJ (Right Face)

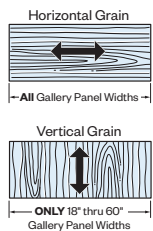

Class BC

Features

- Includes one pre-drilled, finished panel and attachment hardware.
- Gallery Panel is 1.18"(30mm) thick. Compose Beam adds 3"(76mm) to width.
- High Pressure Laminate (HPL) panel has 1mm edgeband.
- Glides provide 1.5"(38mm) level adjustment.
- Beam and hardware are field installed.
- Rail for glass ready option standard in black.
- Handedness is determined by Face Connection.

Specification Tips

- For use at the end of a Compose Beam. Takes the place of Beam End-of-Run Trim.
- Gallery Panels can be the same height or taller than the Beam.
- Gallery Panel has one face connection only; select RH or LH.
- Gallery Panel End attachment is not allowed on the same hand as the face attachment. Refer to the Specification Guide for Face and End mounting application guidelines.
- Specify No Glass option when using Glass Topper Holder Kit.
- "No Glass" Gallery Panels option cannot be retrofit to Glass Ready Option.
- Separately specify:
 - Insert Glass for Glass-Ready Gallery Panels
 - Glass Topper Holder Kit

To Order, Specify:

1) Product number, including:

1 Face Handed Connection

- L** Left Face
- R** Right Face

2 Left End (Finished End or Connection End)

- N** No Connection (Finished End)
- A** 26"(660mm)H or 27"(686mm)H Connection (not available for Left-Hand orientation)
- B** 34"(864mm)H Connection (not available for Left-Hand orientation)
- C** 42"(1067mm)H Connection (not available for Left-Hand orientation)
- D** 50"(1270mm)H Connection (not available for Left-Hand orientation)
- E** 58"(1473mm)H Connection (not available for Left-Hand orientation)

3 Right End (Finished End or Connection End)

- N** No Connection (Finished End)
- A** 26"(660mm)H or 27"(686mm)H Connection (not available for Right-Hand orientation)
- B** 34"(864mm)H Connection (not available for Right-Hand orientation)
- C** 42"(1067mm)H Connection (not available for Right-Hand orientation)
- D** 50"(1270mm)H Connection (not available for Right-Hand orientation)
- E** 58"(1473mm)H Connection (not available for Right-Hand orientation)

4 Glass Options

- N** No Glass (Finished Top)
- G** Glass Ready

2) Laminate surface color.

3) Edgeband color.

Gallery Panel to Compose Beam End-of-Run

L/R (Left or Right Mount)

Nominal Height	Actual Width	Nominal Width	Number		No Glass HPL		Glass Ready HPL	
			①	②③④	A	B	A	B
Gallery Panels 26"(660mm)H-34"(864mm)H								
26"(660mm)	21"(533mm)	18"(457mm)	SY	J-2618-L	\$ 532.58	\$ 535.25	\$ 761.17	\$ 763.84
	27"(686mm)	24"(610mm)	SY	J-2624-L	565.22	573.23	848.31	856.32
	33"(838mm)	30"(762mm)	SY	J-2630-L	597.86	611.21	935.45	948.80
	39"(991mm)	36"(914mm)	SY	J-2636-L	785.94	804.63	1178.03	1196.72
	45"(1143mm)	42"(1067mm)	SY	J-2642-L	915.73	939.76	1362.32	1386.35
	51"(1295mm)	48"(1219mm)	SY	J-2648-L	948.37	977.74	1449.46	1478.83
	57"(1448mm)	54"(1372mm)	SY	J-2654-L	981.01	1015.72	1536.60	1571.31
	63"(1600mm)	60"(1524mm)	SY	J-2660-L	1013.65	1053.70	1623.74	1663.79
	69"(1753mm)	66"(1676mm)	SY	J-2666-L	1046.29	1091.68	1710.88	1756.27
	75"(1905mm)	72"(1829mm)	SY	J-2672-L	1078.93	1129.66	1798.02	1848.75
	81"(2057mm)	78"(1981mm)	SY	J-2678-L	1111.57	1167.64	1885.16	1941.23
	87"(2210mm)	84"(2134mm)	SY	J-2684-L	1144.21	1205.62	1972.30	2033.71
	93"(2362mm)	90"(2286mm)	SY	J-2690-L	1176.85	1243.60	2059.44	2126.19
	99"(2515mm)	96"(2438mm)	SY	J-2696-L	1209.49	1281.58	2146.58	2218.67
	105"(2667mm)	102"(2591mm)	SY	J-26A2-L	1242.13	1319.56	2233.72	2311.15
	111"(2819mm)	108"(2743mm)	SY	J-26A8-L	1274.77	1357.54	2320.86	2403.63
	117"(2972mm)	114"(2896mm)	SY	J-26B4-L	1307.41	1395.52	2408.00	2496.11
27"(686mm)	21"(533mm)	18"(457mm)	SY	J-2718-L	\$ 540.35	\$ 544.29	\$ 768.94	\$ 772.88
	27"(686mm)	24"(610mm)	SY	J-2724-L	572.99	582.27	856.08	865.36
	33"(838mm)	30"(762mm)	SY	J-2730-L	605.63	620.25	943.22	957.84
	39"(991mm)	36"(914mm)	SY	J-2736-L	793.71	813.67	1185.80	1205.76
	45"(1143mm)	42"(1067mm)	SY	J-2742-L	923.50	948.80	1370.09	1395.39
	51"(1295mm)	48"(1219mm)	SY	J-2748-L	956.14	986.78	1457.23	1487.87
	57"(1448mm)	54"(1372mm)	SY	J-2754-L	988.78	1024.76	1544.37	1580.35
	63"(1600mm)	60"(1524mm)	SY	J-2760-L	1021.42	1062.74	1631.51	1672.83
	69"(1753mm)	66"(1676mm)	SY	J-2766-L	1054.06	1100.72	1718.65	1765.31
	75"(1905mm)	72"(1829mm)	SY	J-2772-L	1086.70	1138.70	1805.79	1857.79
	81"(2057mm)	78"(1981mm)	SY	J-2778-L	1119.34	1176.68	1892.93	1950.27
	87"(2210mm)	84"(2134mm)	SY	J-2784-L	1151.98	1214.66	1980.07	2042.75
	93"(2362mm)	90"(2286mm)	SY	J-2790-L	1184.62	1252.64	2067.21	2135.23
	99"(2515mm)	96"(2438mm)	SY	J-2796-L	1217.26	1290.62	2154.35	2227.71
	105"(2667mm)	102"(2591mm)	SY	J-27A2-L	1249.90	1328.60	2241.49	2320.19
	111"(2819mm)	108"(2743mm)	SY	J-27A8-L	1282.54	1366.58	2328.63	2412.67
	117"(2972mm)	114"(2896mm)	SY	J-27B4-L	1315.18	1404.56	2415.77	2505.15
34"(864mm)	21"(533mm)	18"(457mm)	SY	J-3418-L	\$ 594.74	\$ 607.57	\$ 823.33	\$ 836.16
	27"(686mm)	24"(610mm)	SY	J-3424-L	627.38	645.55	910.47	928.64
	33"(838mm)	30"(762mm)	SY	J-3430-L	660.02	683.53	997.61	1021.12
	39"(991mm)	36"(914mm)	SY	J-3436-L	848.10	876.95	1240.19	1269.04
	45"(1143mm)	42"(1067mm)	SY	J-3442-L	977.89	1012.08	1424.48	1458.67
	51"(1295mm)	48"(1219mm)	SY	J-3448-L	1010.53	1050.06	1511.62	1551.15
	57"(1448mm)	54"(1372mm)	SY	J-3454-L	1043.17	1088.04	1598.76	1643.63
	63"(1600mm)	60"(1524mm)	SY	J-3460-L	1075.81	1126.02	1685.90	1736.11
	69"(1753mm)	66"(1676mm)	SY	J-3466-L	1108.45	1164.00	1773.04	1828.59
	75"(1905mm)	72"(1829mm)	SY	J-3472-L	1141.09	1201.98	1860.18	1921.07
	81"(2057mm)	78"(1981mm)	SY	J-3478-L	1173.73	1239.96	1947.32	2013.55
	87"(2210mm)	84"(2134mm)	SY	J-3484-L	1206.37	1277.94	2034.46	2106.03
	93"(2362mm)	90"(2286mm)	SY	J-3490-L	1239.01	1315.92	2121.60	2198.51
	99"(2515mm)	96"(2438mm)	SY	J-3496-L	1271.65	1353.90	2208.74	2290.99
	105"(2667mm)	102"(2591mm)	SY	J-34A2-L	1304.29	1391.88	2295.88	2383.47
	111"(2819mm)	108"(2743mm)	SY	J-34A8-L	1336.93	1429.86	2383.02	2475.95
	117"(2972mm)	114"(2896mm)	SY	J-34B4-L	1369.57	1467.84	2470.16	2568.43

Gallery Panel to Compose Beam End-of-Run

L/R (Left or Right Mount)

Nominal Height	Actual Width	Nominal Width	Number		No Glass HPL		Glass Ready HPL	
			①	②③④	A	B	A	B
Gallery Panels 42"(1067mm)H-50"(1270mm)H								
42"(1067mm)	21"(533mm)	18"(457mm)	SY	J-4218-L	\$ 656.90	\$ 679.89	\$ 885.49	\$ 908.48
	27"(686mm)	24"(610mm)	SY	J-4224-L	689.54	717.87	972.63	1000.96
	33"(838mm)	30"(762mm)	SY	J-4230-L	722.18	755.85	1059.77	1093.44
	39"(991mm)	36"(914mm)	SY	J-4236-L	910.26	949.27	1302.35	1341.36
	45"(1143mm)	42"(1067mm)	SY	J-4242-L	1040.05	1084.40	1486.64	1530.99
	51"(1295mm)	48"(1219mm)	SY	J-4248-L	1072.69	1122.38	1573.78	1623.47
	57"(1448mm)	54"(1372mm)	SY	J-4254-L	1105.33	1160.36	1660.92	1715.95
	63"(1600mm)	60"(1524mm)	SY	J-4260-L	1137.97	1198.34	1748.06	1808.43
	69"(1753mm)	66"(1676mm)	SY	J-4266-L	1170.61	1236.32	1835.20	1900.91
	75"(1905mm)	72"(1829mm)	SY	J-4272-L	1203.25	1274.30	1922.34	1993.39
	81"(2057mm)	78"(1981mm)	SY	J-4278-L	1235.89	1312.28	2009.48	2085.87
	87"(2210mm)	84"(2134mm)	SY	J-4284-L	1268.53	1350.26	2096.62	2178.35
	93"(2362mm)	90"(2286mm)	SY	J-4290-L	1301.17	1388.24	2183.76	2270.83
	99"(2515mm)	96"(2438mm)	SY	J-4296-L	1333.81	1426.22	2270.90	2363.31
	105"(2667mm)	102"(2591mm)	SY	J-42A2-L	1366.45	1464.20	2358.04	2455.79
	111"(2819mm)	108"(2743mm)	SY	J-42A8-L	1399.09	1502.18	2445.18	2548.27
	117"(2972mm)	114"(2896mm)	SY	J-42B4-L	1431.73	1540.16	2532.32	2640.75
50"(1270mm)								
	21"(533mm)	18"(457mm)	SY	J-5018-L	\$ 719.06	\$ 752.21	\$ 947.65	\$ 980.80
	27"(686mm)	24"(610mm)	SY	J-5024-L	751.70	790.19	1034.79	1073.28
	33"(838mm)	30"(762mm)	SY	J-5030-L	784.34	828.17	1121.93	1165.76
	39"(991mm)	36"(914mm)	SY	J-5036-L	972.42	1021.59	1364.51	1413.68
	45"(1143mm)	42"(1067mm)	SY	J-5042-L	1102.21	1156.72	1548.80	1603.31
	51"(1295mm)	48"(1219mm)	SY	J-5048-L	1134.85	1194.70	1635.94	1695.79
	57"(1448mm)	54"(1372mm)	SY	J-5054-L	1167.49	1232.68	1723.08	1788.27
	63"(1600mm)	60"(1524mm)	SY	J-5060-L	1200.13	1270.66	1810.22	1880.75
	69"(1753mm)	66"(1676mm)	SY	J-5066-L	1232.77	1308.64	1897.36	1973.23
	75"(1905mm)	72"(1829mm)	SY	J-5072-L	1265.41	1346.62	1984.50	2065.71
	81"(2057mm)	78"(1981mm)	SY	J-5078-L	1298.05	1384.60	2071.64	2158.19
	87"(2210mm)	84"(2134mm)	SY	J-5084-L	1330.69	1422.58	2158.78	2250.67
	93"(2362mm)	90"(2286mm)	SY	J-5090-L	1363.33	1460.56	2245.92	2343.15
	99"(2515mm)	96"(2438mm)	SY	J-5096-L	1395.97	1498.54	2333.06	2435.63
	105"(2667mm)	102"(2591mm)	SY	J-50A2-L	1428.61	1536.52	2420.20	2528.11
	111"(2819mm)	108"(2743mm)	SY	J-50A8-L	1461.25	1574.50	2507.34	2620.59
	117"(2972mm)	114"(2896mm)	SY	J-50B4-L	1493.89	1612.48	2594.48	2713.07
Gallery Panels 58"(1473mm)H								
58"(1473mm)	21"(533mm)	18"(457mm)	SY	J-5818-L	\$ 781.22	\$ 824.53	\$ 1009.81	\$ 1053.12
	27"(686mm)	24"(610mm)	SY	J-5824-L	813.86	862.51	1096.95	1145.60
	33"(838mm)	30"(762mm)	SY	J-5830-L	846.50	900.49	1184.09	1238.08
	39"(991mm)	36"(914mm)	SY	J-5836-L	1034.58	1093.91	1426.67	1486.00
	45"(1143mm)	42"(1067mm)	SY	J-5842-L	1164.37	1229.04	1610.96	1675.63
	51"(1295mm)	48"(1219mm)	SY	J-5848-L	1197.01	1267.02	1698.10	1768.11
	57"(1448mm)	54"(1372mm)	SY	J-5854-L	1229.65	1305.00	1785.24	1860.59
	63"(1600mm)	60"(1524mm)	SY	J-5860-L	1262.29	1342.98	1872.38	1953.07

Gallery Panel to Compose Beam End-of-Run W/E (Half Left or Half Right Mount)

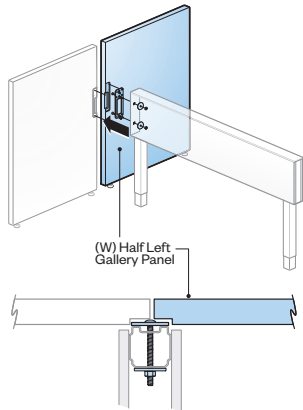

SYWJ (Left Face)

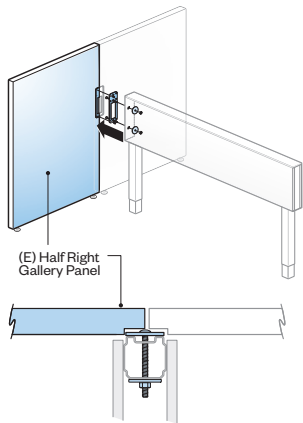

SYEJ (Right Face)

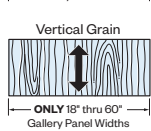
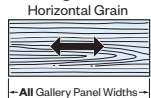

Class BC

Features

- Includes one pre-drilled, finished panel and attachment hardware.
- Gallery Panel is 1.18" (30mm) thick. Half Compose Beam adds 1.5" (38mm) to width.
- High Pressure Laminate (HPL) panel has 1mm edgeband.
- Glides provide 1.5" (38mm) level adjustment.
- Beam and hardware are field installed.
- Rail for glass ready option standard in black.
- Handedness is determined by Face Connection.

Specification Tips

- A Half-Left and a Half-Right Gallery Panel are required for this application. Gallery Panel heights must match, widths may be different.
- For use at the end of a Compose Beam. Takes the place of Beam End-of-Run Trim.
- Gallery Panels can be the same height or taller than the Beam.
- Gallery Panel has one face connection only; select RH or LH.
- Gallery Panel End attachment is not allowed on the same hand as the face attachment. Refer to the Specification Guide for End mounting application guidelines.
- Specify No Glass option when using Glass Topper Holder Kit.
- "No Glass" Gallery Panels option cannot be retrofit to Glass Ready Option.
- Separately specify:
 - Insert Glass for Glass-Ready Gallery Panels
 - Glass Topper Holder Kit

To Order, Specify:

1) Product number, including:

1 Left End (Finished End or Connection End)

- N** No Connection (Finished End)
- A** 26" (660mm)H or 27" (686mm)H Connection (not available for Left-Hand orientation)
- B** 34" (864mm)H Connection (not available for Left-Hand orientation)
- C** 42" (1067mm)H Connection (not available for Left-Hand orientation)
- D** 50" (1270mm)H Connection (not available for Left-Hand orientation)
- E** 58" (1473mm)H Connection (not available for Left-Hand orientation)

2 Right End (Finished End or Connection End)

- N** No Connection (Finished End)
- A** 26" (660mm)H or 27" (686mm)H Connection (not available for Right-Hand orientation)
- B** 34" (864mm)H Connection (not available for Right-Hand orientation)
- C** 42" (1067mm)H Connection (not available for Right-Hand orientation)
- D** 50" (1270mm)H Connection (not available for Right-Hand orientation)
- E** 58" (1473mm)H Connection (not available for Right-Hand orientation)

3 Glass Options

- N** No Glass (Finished Top)
- G** Glass Ready

- 2) Laminate surface color.
- 3) Edgeband color.

Gallery Panel to Compose Beam End-of-Run W/E (Half Left or Half Right Mount)

Nominal Height	Actual Width	Nominal Width	Number 123	No Glass HPL		Glass Ready HPL	
				A	B	A	B
East / Right Face Connection							
Gallery Panels 26"(660mm)H-34"(864mm)H							
26"(660mm)	19.5"(495mm)	18"(457mm)	SYEJ-2618-L N	\$ 532.58	\$ 535.25	\$ 761.17	\$ 763.84
	25.5"(648mm)	24"(610mm)	SYEJ-2624-L N	565.22	573.23	848.31	856.32
	31.5"(800mm)	30"(762mm)	SYEJ-2630-L N	597.86	611.21	935.45	948.80
	37.5"(953mm)	36"(914mm)	SYEJ-2636-L N	785.94	804.63	1178.03	1196.72
	43.5"(1105mm)	42"(1067mm)	SYEJ-2642-L N	915.73	939.76	1362.32	1386.35
	49.5"(1257mm)	48"(1219mm)	SYEJ-2648-L N	948.37	977.74	1449.46	1478.83
	55.5"(1410mm)	54"(1372mm)	SYEJ-2654-L N	981.01	1015.72	1536.60	1571.31
	61.5"(1562mm)	60"(1524mm)	SYEJ-2660-L N	1013.65	1053.70	1623.74	1663.79
	67.5"(1715mm)	66"(1676mm)	SYEJ-2666-L N	1046.29	1091.68	1710.88	1756.27
	73.5"(1867mm)	72"(1829mm)	SYEJ-2672-L N	1078.93	1129.66	1798.02	1848.75
	79.5"(2019mm)	78"(1981mm)	SYEJ-2678-L N	1111.57	1167.64	1885.16	1941.23
	85.5"(2172mm)	84"(2134mm)	SYEJ-2684-L N	1144.21	1205.62	1972.30	2033.71
	91.5"(2324mm)	90"(2286mm)	SYEJ-2690-L N	1176.85	1243.60	2059.44	2126.19
	97.5"(2477mm)	96"(2438mm)	SYEJ-2696-L N	1209.49	1281.58	2146.58	2218.67
	103.5"(2629mm)	102"(2591mm)	SYEJ-26A2-L N	1242.13	1319.56	2233.72	2311.15
	109.5"(2781mm)	108"(2743mm)	SYEJ-26A8-L N	1274.77	1357.54	2320.86	2403.63
	115.5"(2934mm)	114"(2896mm)	SYEJ-26B4-L N	1307.41	1395.52	2408.00	2496.11
27"(686mm)	19.5"(495mm)	18"(457mm)	SYEJ-2718-L N	\$ 540.35	\$ 544.29	\$ 768.94	\$ 772.88
	25.5"(648mm)	24"(610mm)	SYEJ-2724-L N	572.99	582.27	856.08	865.36
	31.5"(800mm)	30"(762mm)	SYEJ-2730-L N	605.63	620.25	943.22	957.84
	37.5"(953mm)	36"(914mm)	SYEJ-2736-L N	793.71	813.67	1185.80	1205.76
	43.5"(1105mm)	42"(1067mm)	SYEJ-2742-L N	923.50	948.80	1370.09	1395.39
	49.5"(1257mm)	48"(1219mm)	SYEJ-2748-L N	956.14	986.78	1457.23	1487.87
	55.5"(1410mm)	54"(1372mm)	SYEJ-2754-L N	988.78	1024.76	1544.37	1580.35
	61.5"(1562mm)	60"(1524mm)	SYEJ-2760-L N	1021.42	1062.74	1631.51	1672.83
	67.5"(1715mm)	66"(1676mm)	SYEJ-2766-L N	1054.06	1100.72	1718.65	1765.31
	73.5"(1867mm)	72"(1829mm)	SYEJ-2772-L N	1086.70	1138.70	1805.79	1857.79
	79.5"(2019mm)	78"(1981mm)	SYEJ-2778-L N	1119.34	1176.68	1892.93	1950.27
	85.5"(2172mm)	84"(2134mm)	SYEJ-2784-L N	1151.98	1214.66	1980.07	2042.75
	91.5"(2324mm)	90"(2286mm)	SYEJ-2790-L N	1184.62	1252.64	2067.21	2135.23
	97.5"(2477mm)	96"(2438mm)	SYEJ-2796-L N	1217.26	1290.62	2154.35	2227.71
	103.5"(2629mm)	102"(2591mm)	SYEJ-27A2-L N	1249.90	1328.60	2241.49	2320.19
	109.5"(2781mm)	108"(2743mm)	SYEJ-27A8-L N	1282.54	1366.58	2328.63	2412.67
	115.5"(2934mm)	114"(2896mm)	SYEJ-27B4-L N	1315.18	1404.56	2415.77	2505.15
34"(864mm)	19.5"(495mm)	18"(457mm)	SYEJ-3418-L N	\$ 594.74	\$ 607.57	\$ 823.33	\$ 836.16
	25.5"(648mm)	24"(610mm)	SYEJ-3424-L N	627.38	645.55	910.47	928.64
	31.5"(800mm)	30"(762mm)	SYEJ-3430-L N	660.02	683.53	997.61	1021.12
	37.5"(953mm)	36"(914mm)	SYEJ-3436-L N	848.10	876.95	1240.19	1269.04
	43.5"(1105mm)	42"(1067mm)	SYEJ-3442-L N	977.89	1012.08	1424.48	1458.67
	49.5"(1257mm)	48"(1219mm)	SYEJ-3448-L N	1010.53	1050.06	1511.62	1551.15
	55.5"(1410mm)	54"(1372mm)	SYEJ-3454-L N	1043.17	1088.04	1598.76	1643.63
	61.5"(1562mm)	60"(1524mm)	SYEJ-3460-L N	1075.81	1126.02	1685.90	1736.11
	67.5"(1715mm)	66"(1676mm)	SYEJ-3466-L N	1108.45	1164.00	1773.04	1828.59
	73.5"(1867mm)	72"(1829mm)	SYEJ-3472-L N	1141.09	1201.98	1860.18	1921.07
	79.5"(2019mm)	78"(1981mm)	SYEJ-3478-L N	1173.73	1239.96	1947.32	2013.55
	85.5"(2172mm)	84"(2134mm)	SYEJ-3484-L N	1206.37	1277.94	2034.46	2106.03
	91.5"(2324mm)	90"(2286mm)	SYEJ-3490-L N	1239.01	1315.92	2121.60	2198.51
	97.5"(2477mm)	96"(2438mm)	SYEJ-3496-L N	1271.65	1353.90	2208.74	2290.99
	103.5"(2629mm)	102"(2591mm)	SYEJ-34A2-L N	1304.29	1391.88	2295.88	2383.47
	109.5"(2781mm)	108"(2743mm)	SYEJ-34A8-L N	1336.93	1429.86	2383.02	2475.95
	115.5"(2934mm)	114"(2896mm)	SYEJ-34B4-L N	1369.57	1467.84	2470.16	2568.43

Gallery Panel to Compose Beam End-of-Run W/E (Half Left or Half Right Mount)

Nominal Height	Actual Width	Nominal Width	Number ①②③	No Glass HPL		Glass Ready HPL	
				A	B	A	B
Gallery Panels 42"(1067mm)H-50"(1270mm)H							
42"(1067mm)	19.5"(495mm)	18"(457mm)	SYEJ-4218-L N	\$ 656.90	\$ 679.89	\$ 885.49	\$ 908.48
	25.5"(648mm)	24"(610mm)	SYEJ-4224-L N	689.54	717.87	972.63	1000.96
	31.5"(800mm)	30"(762mm)	SYEJ-4230-L N	722.18	755.85	1059.77	1093.44
	37.5"(953mm)	36"(914mm)	SYEJ-4236-L N	910.26	949.27	1302.35	1341.36
	43.5"(1105mm)	42"(1067mm)	SYEJ-4242-L N	1040.05	1084.40	1486.64	1530.99
	49.5"(1257mm)	48"(1219mm)	SYEJ-4248-L N	1072.69	1122.38	1573.78	1623.47
	55.5"(1410mm)	54"(1372mm)	SYEJ-4254-L N	1105.33	1160.36	1660.92	1715.95
	61.5"(1562mm)	60"(1524mm)	SYEJ-4260-L N	1137.97	1198.34	1748.06	1808.43
	67.5"(1715mm)	66"(1676mm)	SYEJ-4266-L N	1170.61	1236.32	1835.20	1900.91
	73.5"(1867mm)	72"(1829mm)	SYEJ-4272-L N	1203.25	1274.30	1922.34	1993.39
	79.5"(2019mm)	78"(1981mm)	SYEJ-4278-L N	1235.89	1312.28	2009.48	2085.87
	85.5"(2172mm)	84"(2134mm)	SYEJ-4284-L N	1268.53	1350.26	2096.62	2178.35
	91.5"(2324mm)	90"(2286mm)	SYEJ-4290-L N	1301.17	1388.24	2183.76	2270.83
	97.5"(2477mm)	96"(2438mm)	SYEJ-4296-L N	1333.81	1426.22	2270.90	2363.31
	103.5"(2629mm)	102"(2591mm)	SYEJ-42A2-L N	1366.45	1464.20	2358.04	2455.79
	109.5"(2781mm)	108"(2743mm)	SYEJ-42A8-L N	1399.09	1502.18	2445.18	2548.27
	115.5"(2934mm)	114"(2896mm)	SYEJ-42B4-L N	1431.73	1540.16	2532.32	2640.75
50"(1270mm)							
	19.5"(495mm)	18"(457mm)	SYEJ-5018-L N	\$ 719.06	\$ 752.21	\$ 947.65	\$ 980.80
	25.5"(648mm)	24"(610mm)	SYEJ-5024-L N	751.70	790.19	1034.79	1073.28
	31.5"(800mm)	30"(762mm)	SYEJ-5030-L N	784.34	828.17	1121.93	1165.76
	37.5"(953mm)	36"(914mm)	SYEJ-5036-L N	972.42	1021.59	1364.51	1413.68
	43.5"(1105mm)	42"(1067mm)	SYEJ-5042-L N	1102.21	1156.72	1548.80	1603.31
	49.5"(1257mm)	48"(1219mm)	SYEJ-5048-L N	1134.85	1194.70	1635.94	1695.79
	55.5"(1410mm)	54"(1372mm)	SYEJ-5054-L N	1167.49	1232.68	1723.08	1788.27
	61.5"(1562mm)	60"(1524mm)	SYEJ-5060-L N	1200.13	1270.66	1810.22	1880.75
	67.5"(1715mm)	66"(1676mm)	SYEJ-5066-L N	1232.77	1308.64	1897.36	1973.23
	73.5"(1867mm)	72"(1829mm)	SYEJ-5072-L N	1265.41	1346.62	1984.50	2065.71
	79.5"(2019mm)	78"(1981mm)	SYEJ-5078-L N	1298.05	1384.60	2071.64	2158.19
	85.5"(2172mm)	84"(2134mm)	SYEJ-5084-L N	1330.69	1422.58	2158.78	2250.67
	91.5"(2324mm)	90"(2286mm)	SYEJ-5090-L N	1363.33	1460.56	2245.92	2343.15
	97.5"(2477mm)	96"(2438mm)	SYEJ-5096-L N	1395.97	1498.54	2333.06	2435.63
	103.5"(2629mm)	102"(2591mm)	SYEJ-50A2-L N	1428.61	1536.52	2420.20	2528.11
	109.5"(2781mm)	108"(2743mm)	SYEJ-50A8-L N	1461.25	1574.50	2507.34	2620.59
	115.5"(2934mm)	114"(2896mm)	SYEJ-50B4-L N	1493.89	1612.48	2594.48	2713.07
Gallery Panels 58"(1473mm)H							
58"(1473mm)	19.5"(495mm)	18"(457mm)	SYEJ-5818-L N	\$ 781.22	\$ 824.53	\$ 1009.81	\$ 1053.12
	25.5"(648mm)	24"(610mm)	SYEJ-5824-L N	813.86	862.51	1096.95	1145.60
	31.5"(800mm)	30"(762mm)	SYEJ-5830-L N	846.50	900.49	1184.09	1238.08
	37.5"(953mm)	36"(914mm)	SYEJ-5836-L N	1034.58	1093.91	1426.67	1486.00
	43.5"(1105mm)	42"(1067mm)	SYEJ-5842-L N	1164.37	1229.04	1610.96	1675.63
	49.5"(1257mm)	48"(1219mm)	SYEJ-5848-L N	1197.01	1267.02	1698.10	1768.11
	55.5"(1410mm)	54"(1372mm)	SYEJ-5854-L N	1229.65	1305.00	1785.24	1860.59
	61.5"(1562mm)	60"(1524mm)	SYEJ-5860-L N	1262.29	1342.98	1872.38	1953.07

Gallery Panel to Compose Beam End-of-Run W/E (Half Left or Half Right Mount)

Nominal Height	Actual Width	Nominal Width	Number ①②③	No Glass HPL		Glass Ready HPL	
				A	B	A	B
West / Left Face Connection							
Gallery Panels 26"(660mm)H-34"(864mm)H							
26"(660mm)	19.5"(495mm)	18"(457mm)	SYWJ-2618-LN ■■	\$ 532.58	\$ 535.25	\$ 761.17	\$ 763.84
	25.5"(648mm)	24"(610mm)	SYWJ-2624-LN ■■	565.22	573.23	848.31	856.32
	31.5"(800mm)	30"(762mm)	SYWJ-2630-LN ■■	597.86	611.21	935.45	948.80
	37.5"(953mm)	36"(914mm)	SYWJ-2636-LN ■■	785.94	804.63	1178.03	1196.72
	43.5"(1105mm)	42"(1067mm)	SYWJ-2642-LN ■■	915.73	939.76	1362.32	1386.35
	49.5"(1257mm)	48"(1219mm)	SYWJ-2648-LN ■■	948.37	977.74	1449.46	1478.83
	55.5"(1410mm)	54"(1372mm)	SYWJ-2654-LN ■■	981.01	1015.72	1536.60	1571.31
	61.5"(1562mm)	60"(1524mm)	SYWJ-2660-LN ■■	1013.65	1053.70	1623.74	1663.79
	67.5"(1715mm)	66"(1676mm)	SYWJ-2666-LN ■■	1046.29	1091.68	1710.88	1756.27
	73.5"(1867mm)	72"(1829mm)	SYWJ-2672-LN ■■	1078.93	1129.66	1798.02	1848.75
	79.5"(2019mm)	78"(1981mm)	SYWJ-2678-LN ■■	1111.57	1167.64	1885.16	1941.23
	85.5"(2172mm)	84"(2134mm)	SYWJ-2684-LN ■■	1144.21	1205.62	1972.30	2033.71
	91.5"(2324mm)	90"(2286mm)	SYWJ-2690-LN ■■	1176.85	1243.60	2059.44	2126.19
	97.5"(2477mm)	96"(2438mm)	SYWJ-2696-LN ■■	1209.49	1281.58	2146.58	2218.67
	103.5"(2629mm)	102"(2591mm)	SYWJ-26A2-LN ■■	1242.13	1319.56	2233.72	2311.15
	109.5"(2781mm)	108"(2743mm)	SYWJ-26A8-LN ■■	1274.77	1357.54	2320.86	2403.63
	115.5"(2934mm)	114"(2896mm)	SYWJ-26B4-LN ■■	1307.41	1395.52	2408.00	2496.11
27"(686mm)	19.5"(495mm)	18"(457mm)	SYWJ-2718-LN ■■	\$ 540.35	\$ 544.29	\$ 768.94	\$ 772.88
	25.5"(648mm)	24"(610mm)	SYWJ-2724-LN ■■	572.99	582.27	856.08	865.36
	31.5"(800mm)	30"(762mm)	SYWJ-2730-LN ■■	605.63	620.25	943.22	957.84
	37.5"(953mm)	36"(914mm)	SYWJ-2736-LN ■■	793.71	813.67	1185.80	1205.76
	43.5"(1105mm)	42"(1067mm)	SYWJ-2742-LN ■■	923.50	948.80	1370.09	1395.39
	49.5"(1257mm)	48"(1219mm)	SYWJ-2748-LN ■■	956.14	986.78	1457.23	1487.87
	55.5"(1410mm)	54"(1372mm)	SYWJ-2754-LN ■■	988.78	1024.76	1544.37	1580.35
	61.5"(1562mm)	60"(1524mm)	SYWJ-2760-LN ■■	1021.42	1062.74	1631.51	1672.83
	67.5"(1715mm)	66"(1676mm)	SYWJ-2766-LN ■■	1054.06	1100.72	1718.65	1765.31
	73.5"(1867mm)	72"(1829mm)	SYWJ-2772-LN ■■	1086.70	1138.70	1805.79	1857.79
	79.5"(2019mm)	78"(1981mm)	SYWJ-2778-LN ■■	1119.34	1176.68	1892.93	1950.27
	85.5"(2172mm)	84"(2134mm)	SYWJ-2784-LN ■■	1151.98	1214.66	1980.07	2042.75
	91.5"(2324mm)	90"(2286mm)	SYWJ-2790-LN ■■	1184.62	1252.64	2067.21	2135.23
	97.5"(2477mm)	96"(2438mm)	SYWJ-2796-LN ■■	1217.26	1290.62	2154.35	2227.71
	103.5"(2629mm)	102"(2591mm)	SYWJ-27A2-LN ■■	1249.90	1328.60	2241.49	2320.19
	109.5"(2781mm)	108"(2743mm)	SYWJ-27A8-LN ■■	1282.54	1366.58	2328.63	2412.67
	115.5"(2934mm)	114"(2896mm)	SYWJ-27B4-LN ■■	1315.18	1404.56	2415.77	2505.15
34"(864mm)	19.5"(495mm)	18"(457mm)	SYWJ-3418-LN ■■	\$ 594.74	\$ 607.57	\$ 823.33	\$ 836.16
	25.5"(648mm)	24"(610mm)	SYWJ-3424-LN ■■	627.38	645.55	910.47	928.64
	31.5"(800mm)	30"(762mm)	SYWJ-3430-LN ■■	660.02	683.53	997.61	1021.12
	37.5"(953mm)	36"(914mm)	SYWJ-3436-LN ■■	848.10	876.95	1240.19	1269.04
	43.5"(1105mm)	42"(1067mm)	SYWJ-3442-LN ■■	977.89	1012.08	1424.48	1458.67
	49.5"(1257mm)	48"(1219mm)	SYWJ-3448-LN ■■	1010.53	1050.06	1511.62	1551.15
	55.5"(1410mm)	54"(1372mm)	SYWJ-3454-LN ■■	1043.17	1088.04	1598.76	1643.63
	61.5"(1562mm)	60"(1524mm)	SYWJ-3460-LN ■■	1075.81	1126.02	1685.90	1736.11
	67.5"(1715mm)	66"(1676mm)	SYWJ-3466-LN ■■	1108.45	1164.00	1773.04	1828.59
	73.5"(1867mm)	72"(1829mm)	SYWJ-3472-LN ■■	1141.09	1201.98	1860.18	1921.07
	79.5"(2019mm)	78"(1981mm)	SYWJ-3478-LN ■■	1173.73	1239.96	1947.32	2013.55
	85.5"(2172mm)	84"(2134mm)	SYWJ-3484-LN ■■	1206.37	1277.94	2034.46	2106.03
	91.5"(2324mm)	90"(2286mm)	SYWJ-3490-LN ■■	1239.01	1315.92	2121.60	2198.51
	97.5"(2477mm)	96"(2438mm)	SYWJ-3496-LN ■■	1271.65	1353.90	2208.74	2290.99
	103.5"(2629mm)	102"(2591mm)	SYWJ-34A2-LN ■■	1304.29	1391.88	2295.88	2383.47
	109.5"(2781mm)	108"(2743mm)	SYWJ-34A8-LN ■■	1336.93	1429.86	2383.02	2475.95
	115.5"(2934mm)	114"(2896mm)	SYWJ-34B4-LN ■■	1369.57	1467.84	2470.16	2568.43

Gallery Panel to Compose Beam End-of-Run W/E (Half Left or Half Right Mount)

Nominal Height	Actual Width	Nominal Width	Number ①②③	No Glass HPL		Glass Ready HPL	
				A	B	A	B
Gallery Panels 42"(1067mm)H-50"(1270mm)H							
42"(1067mm)	19.5"(495mm)	18"(457mm)	SYWJ-4218-LN ■■	\$ 656.90	\$ 679.89	\$ 885.49	\$ 908.48
	25.5"(648mm)	24"(610mm)	SYWJ-4224-LN ■■	689.54	717.87	972.63	1000.96
	31.5"(800mm)	30"(762mm)	SYWJ-4230-LN ■■	722.18	755.85	1059.77	1093.44
	37.5"(953mm)	36"(914mm)	SYWJ-4236-LN ■■	910.26	949.27	1302.35	1341.36
	43.5"(1105mm)	42"(1067mm)	SYWJ-4242-LN ■■	1040.05	1084.40	1486.64	1530.99
	49.5"(1257mm)	48"(1219mm)	SYWJ-4248-LN ■■	1072.69	1122.38	1573.78	1623.47
	55.5"(1410mm)	54"(1372mm)	SYWJ-4254-LN ■■	1105.33	1160.36	1660.92	1715.95
	61.5"(1562mm)	60"(1524mm)	SYWJ-4260-LN ■■	1137.97	1198.34	1748.06	1808.43
	67.5"(1715mm)	66"(1676mm)	SYWJ-4266-LN ■■	1170.61	1236.32	1835.20	1900.91
	73.5"(1867mm)	72"(1829mm)	SYWJ-4272-LN ■■	1203.25	1274.30	1922.34	1993.39
	79.5"(2019mm)	78"(1981mm)	SYWJ-4278-LN ■■	1235.89	1312.28	2009.48	2085.87
	85.5"(2172mm)	84"(2134mm)	SYWJ-4284-LN ■■	1268.53	1350.26	2096.62	2178.35
	91.5"(2324mm)	90"(2286mm)	SYWJ-4290-LN ■■	1301.17	1388.24	2183.76	2270.83
	97.5"(2477mm)	96"(2438mm)	SYWJ-4296-LN ■■	1333.81	1426.22	2270.90	2363.31
	103.5"(2629mm)	102"(2591mm)	SYWJ-42A2-LN ■■	1366.45	1464.20	2358.04	2455.79
	109.5"(2781mm)	108"(2743mm)	SYWJ-42A8-LN ■■	1399.09	1502.18	2445.18	2548.27
	115.5"(2934mm)	114"(2896mm)	SYWJ-42B4-LN ■■	1431.73	1540.16	2532.32	2640.75
50"(1270mm)							
	19.5"(495mm)	18"(457mm)	SYWJ-5018-LN ■■	\$ 719.06	\$ 752.21	\$ 947.65	\$ 980.80
	25.5"(648mm)	24"(610mm)	SYWJ-5024-LN ■■	751.70	790.19	1034.79	1073.28
	31.5"(800mm)	30"(762mm)	SYWJ-5030-LN ■■	784.34	828.17	1121.93	1165.76
	37.5"(953mm)	36"(914mm)	SYWJ-5036-LN ■■	972.42	1021.59	1364.51	1413.68
	43.5"(1105mm)	42"(1067mm)	SYWJ-5042-LN ■■	1102.21	1156.72	1548.80	1603.31
	49.5"(1257mm)	48"(1219mm)	SYWJ-5048-LN ■■	1134.85	1194.70	1635.94	1695.79
	55.5"(1410mm)	54"(1372mm)	SYWJ-5054-LN ■■	1167.49	1232.68	1723.08	1788.27
	61.5"(1562mm)	60"(1524mm)	SYWJ-5060-LN ■■	1200.13	1270.66	1810.22	1880.75
	67.5"(1715mm)	66"(1676mm)	SYWJ-5066-LN ■■	1232.77	1308.64	1897.36	1973.23
	73.5"(1867mm)	72"(1829mm)	SYWJ-5072-LN ■■	1265.41	1346.62	1984.50	2065.71
	79.5"(2019mm)	78"(1981mm)	SYWJ-5078-LN ■■	1298.05	1384.60	2071.64	2158.19
	85.5"(2172mm)	84"(2134mm)	SYWJ-5084-LN ■■	1330.69	1422.58	2158.78	2250.67
	91.5"(2324mm)	90"(2286mm)	SYWJ-5090-LN ■■	1363.33	1460.56	2245.92	2343.15
	97.5"(2477mm)	96"(2438mm)	SYWJ-5096-LN ■■	1395.97	1498.54	2333.06	2435.63
	103.5"(2629mm)	102"(2591mm)	SYWJ-50A2-LN ■■	1428.61	1536.52	2420.20	2528.11
	109.5"(2781mm)	108"(2743mm)	SYWJ-50A8-LN ■■	1461.25	1574.50	2507.34	2620.59
	115.5"(2934mm)	114"(2896mm)	SYWJ-50B4-LN ■■	1493.89	1612.48	2594.48	2713.07
Gallery Panels 58"(1473mm)H							
58"(1473mm)	19.5"(495mm)	18"(457mm)	SYWJ-5818-LN ■■	\$ 781.22	\$ 824.53	\$ 1009.81	\$ 1053.12
	25.5"(648mm)	24"(610mm)	SYWJ-5824-LN ■■	813.86	862.51	1096.95	1145.60
	31.5"(800mm)	30"(762mm)	SYWJ-5830-LN ■■	846.50	900.49	1184.09	1238.08
	37.5"(953mm)	36"(914mm)	SYWJ-5836-LN ■■	1034.58	1093.91	1426.67	1486.00
	43.5"(1105mm)	42"(1067mm)	SYWJ-5842-LN ■■	1164.37	1229.04	1610.96	1675.63
	49.5"(1257mm)	48"(1219mm)	SYWJ-5848-LN ■■	1197.01	1267.02	1698.10	1768.11
	55.5"(1410mm)	54"(1372mm)	SYWJ-5854-LN ■■	1229.65	1305.00	1785.24	1860.59
	61.5"(1562mm)	60"(1524mm)	SYWJ-5860-LN ■■	1262.29	1342.98	1872.38	1953.07

Gallery Panel to Compose Beam End-of-Run C (Center Mount)

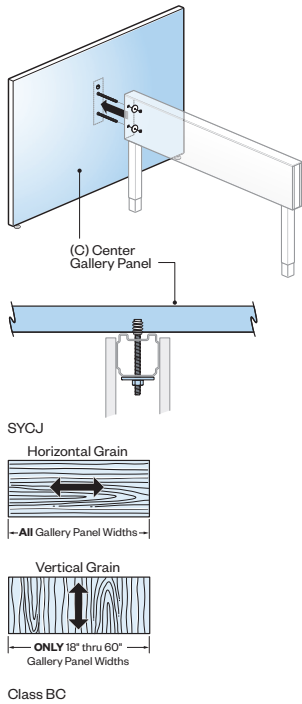

Features

- Includes one pre-drilled, finished panel and attachment hardware.
- Gallery Panel is 1.18" (30mm) thick. Compose Beam adds 3" (76mm) to width.
- High Pressure Laminate (HPL) panel has 1mm edgeband.
- Glides provide 1.5" (38mm) level adjustment.
- Beam and hardware are field installed.
- Rail for glass ready option standard in black.
- Handedness is determined by Face Connection.

Specification Tips

- For use at the end of a Compose Beam. Takes the place of Beam End-of-Run Trim.
- Gallery Panels can be the same height or taller than the Beam.
- Gallery Panel has one center face connection only.
- Refer to the Specification Guide for End mounting application guidelines.
- Specify No Glass option when using Glass Topper Holder Kit.
- "No Glass" Gallery Panels option cannot be retrofit to Glass Ready Option.
- Separately specify:
 - Insert Glass for Glass-Ready Gallery Panels
 - Glass Topper Holder Kit

To Order, Specify:

1) Product number, including:

1 Left End (Finished End or Connection End)

- N** No Connection (Finished End)
- A** 26" (660mm)H or 27" (686mm)H Connection
- B** 34" (864mm)H Connection
- C** 42" (1067mm)H Connection
- D** 50" (1270mm)H Connection
- E** 58" (1473mm)H Connection

2 Right End (Finished End or Connection End)

- N** No Connection (Finished End)
- A** 26" (660mm)H or 27" (686mm)H Connection
- B** 34" (864mm)H Connection
- C** 42" (1067mm)H Connection
- D** 50" (1270mm)H Connection
- E** 58" (1473mm)H Connection

3 Glass Options

- N** No Glass (Finished Top)
- G** Glass Ready

2) Laminate surface color.
3) Edgeband color.

Gallery Panel to Compose Beam End-of-Run C (Center Mount)

Nominal Height	Actual Width	Nominal Width	Number ①②③	No Glass HPL		Glass Ready HPL	
				A	B	A	B
Gallery Panels 26"(660mm)H-34"(864mm)H							
26"(660mm)	21"(533mm)	18"(457mm)	SYCJ-2618-L	\$ 532.58	\$ 535.25	\$ 761.17	\$ 763.84
	27"(686mm)	24"(610mm)	SYCJ-2624-L	565.22	573.23	848.31	856.32
	33"(838mm)	30"(762mm)	SYCJ-2630-L	597.86	611.21	935.45	948.80
	39"(991mm)	36"(914mm)	SYCJ-2636-L	785.94	804.63	1178.03	1196.72
	45"(1143mm)	42"(1067mm)	SYCJ-2642-L	915.73	939.76	1362.32	1386.35
	51"(1295mm)	48"(1219mm)	SYCJ-2648-L	948.37	977.74	1449.46	1478.83
	57"(1448mm)	54"(1372mm)	SYCJ-2654-L	981.01	1015.72	1536.60	1571.31
	63"(1600mm)	60"(1524mm)	SYCJ-2660-L	1013.65	1053.70	1623.74	1663.79
	69"(1753mm)	66"(1676mm)	SYCJ-2666-L	1046.29	1091.68	1710.88	1756.27
	75"(1905mm)	72"(1829mm)	SYCJ-2672-L	1078.93	1129.66	1798.02	1848.75
	81"(2057mm)	78"(1981mm)	SYCJ-2678-L	1111.57	1167.64	1885.16	1941.23
	87"(2210mm)	84"(2134mm)	SYCJ-2684-L	1144.21	1205.62	1972.30	2033.71
	93"(2362mm)	90"(2286mm)	SYCJ-2690-L	1176.85	1243.60	2059.44	2126.19
	99"(2515mm)	96"(2438mm)	SYCJ-2696-L	1209.49	1281.58	2146.58	2218.67
105"(2667mm)	102"(2591mm)	SYCJ-26A2-L	1242.13	1319.56	2233.72	2311.15	
111"(2819mm)	108"(2743mm)	SYCJ-26A8-L	1274.77	1357.54	2320.86	2403.63	
117"(2972mm)	114"(2896mm)	SYCJ-26B4-L	1307.41	1395.52	2408.00	2496.11	
27"(686mm)	21"(533mm)	18"(457mm)	SYCJ-2718-L	\$ 540.35	\$ 544.29	\$ 768.94	\$ 772.88
	27"(686mm)	24"(610mm)	SYCJ-2724-L	572.99	582.27	856.08	865.36
	33"(838mm)	30"(762mm)	SYCJ-2730-L	605.63	620.25	943.22	957.84
	39"(991mm)	36"(914mm)	SYCJ-2736-L	793.71	813.67	1185.80	1205.76
	45"(1143mm)	42"(1067mm)	SYCJ-2742-L	923.50	948.80	1370.09	1395.39
	51"(1295mm)	48"(1219mm)	SYCJ-2748-L	956.14	986.78	1457.23	1487.87
	57"(1448mm)	54"(1372mm)	SYCJ-2754-L	988.78	1024.76	1544.37	1580.35
	63"(1600mm)	60"(1524mm)	SYCJ-2760-L	1021.42	1062.74	1631.51	1672.83
	69"(1753mm)	66"(1676mm)	SYCJ-2766-L	1054.06	1100.72	1718.65	1765.31
	75"(1905mm)	72"(1829mm)	SYCJ-2772-L	1086.70	1138.70	1805.79	1857.79
	81"(2057mm)	78"(1981mm)	SYCJ-2778-L	1119.34	1176.68	1892.93	1950.27
	87"(2210mm)	84"(2134mm)	SYCJ-2784-L	1151.98	1214.66	1980.07	2042.75
	93"(2362mm)	90"(2286mm)	SYCJ-2790-L	1184.62	1252.64	2067.21	2135.23
	99"(2515mm)	96"(2438mm)	SYCJ-2796-L	1217.26	1290.62	2154.35	2227.71
105"(2667mm)	102"(2591mm)	SYCJ-27A2-L	1249.90	1328.60	2241.49	2320.19	
111"(2819mm)	108"(2743mm)	SYCJ-27A8-L	1282.54	1366.58	2328.63	2412.67	
117"(2972mm)	114"(2896mm)	SYCJ-27B4-L	1315.18	1404.56	2415.77	2505.15	
34"(864mm)	21"(533mm)	18"(457mm)	SYCJ-3418-L	\$ 594.74	\$ 607.57	\$ 823.33	\$ 836.16
	27"(686mm)	24"(610mm)	SYCJ-3424-L	627.38	645.55	910.47	928.64
	33"(838mm)	30"(762mm)	SYCJ-3430-L	660.02	683.53	997.61	1021.12
	39"(991mm)	36"(914mm)	SYCJ-3436-L	848.10	876.95	1240.19	1269.04
	45"(1143mm)	42"(1067mm)	SYCJ-3442-L	977.89	1012.08	1424.48	1458.67
	51"(1295mm)	48"(1219mm)	SYCJ-3448-L	1010.53	1050.06	1511.62	1551.15
	57"(1448mm)	54"(1372mm)	SYCJ-3454-L	1043.17	1088.04	1598.76	1643.63
	63"(1600mm)	60"(1524mm)	SYCJ-3460-L	1075.81	1126.02	1685.90	1736.11
	69"(1753mm)	66"(1676mm)	SYCJ-3466-L	1108.45	1164.00	1773.04	1828.59
	75"(1905mm)	72"(1829mm)	SYCJ-3472-L	1141.09	1201.98	1860.18	1921.07
	81"(2057mm)	78"(1981mm)	SYCJ-3478-L	1173.73	1239.96	1947.32	2013.55
	87"(2210mm)	84"(2134mm)	SYCJ-3484-L	1206.37	1277.94	2034.46	2106.03
	93"(2362mm)	90"(2286mm)	SYCJ-3490-L	1239.01	1315.92	2121.60	2198.51
	99"(2515mm)	96"(2438mm)	SYCJ-3496-L	1271.65	1353.90	2208.74	2290.99
105"(2667mm)	102"(2591mm)	SYCJ-34A2-L	1304.29	1391.88	2295.88	2383.47	
111"(2819mm)	108"(2743mm)	SYCJ-34A8-L	1336.93	1429.86	2383.02	2475.95	
117"(2972mm)	114"(2896mm)	SYCJ-34B4-L	1369.57	1467.84	2470.16	2568.43	

Gallery Panel to Compose Beam End-of-Run C (Center Mount)

Nominal Height	Actual Width	Nominal Width	Number ①②③	No Glass HPL		Glass Ready HPL	
				A	B	A	B
Gallery Panels 42"(1067mm)H-50"(1270mm)H							
42"(1067mm)	21"(533mm)	18"(457mm)	SYCJ-4218-L	\$ 656.90	\$ 679.89	\$ 885.49	\$ 908.48
	27"(686mm)	24"(610mm)	SYCJ-4224-L	689.54	717.87	972.63	1000.96
	33"(838mm)	30"(762mm)	SYCJ-4230-L	722.18	755.85	1059.77	1093.44
	39"(991mm)	36"(914mm)	SYCJ-4236-L	910.26	949.27	1302.35	1341.36
	45"(1143mm)	42"(1067mm)	SYCJ-4242-L	1040.05	1084.40	1486.64	1530.99
	51"(1295mm)	48"(1219mm)	SYCJ-4248-L	1072.69	1122.38	1573.78	1623.47
	57"(1448mm)	54"(1372mm)	SYCJ-4254-L	1105.33	1160.36	1660.92	1715.95
	63"(1600mm)	60"(1524mm)	SYCJ-4260-L	1137.97	1198.34	1748.06	1808.43
	69"(1753mm)	66"(1676mm)	SYCJ-4266-L	1170.61	1236.32	1835.20	1900.91
	75"(1905mm)	72"(1829mm)	SYCJ-4272-L	1203.25	1274.30	1922.34	1993.39
	81"(2057mm)	78"(1981mm)	SYCJ-4278-L	1235.89	1312.28	2009.48	2085.87
	87"(2210mm)	84"(2134mm)	SYCJ-4284-L	1268.53	1350.26	2096.62	2178.35
	93"(2362mm)	90"(2286mm)	SYCJ-4290-L	1301.17	1388.24	2183.76	2270.83
	99"(2515mm)	96"(2438mm)	SYCJ-4296-L	1333.81	1426.22	2270.90	2363.31
	105"(2667mm)	102"(2591mm)	SYCJ-42A2-L	1366.45	1464.20	2358.04	2455.79
	111"(2819mm)	108"(2743mm)	SYCJ-42A8-L	1399.09	1502.18	2445.18	2548.27
	117"(2972mm)	114"(2896mm)	SYCJ-42B4-L	1431.73	1540.16	2532.32	2640.75
50"(1270mm)							
	21"(533mm)	18"(457mm)	SYCJ-5018-L	\$ 719.06	\$ 752.21	\$ 947.65	\$ 980.80
	27"(686mm)	24"(610mm)	SYCJ-5024-L	751.70	790.19	1034.79	1073.28
	33"(838mm)	30"(762mm)	SYCJ-5030-L	784.34	828.17	1121.93	1165.76
	39"(991mm)	36"(914mm)	SYCJ-5036-L	972.42	1021.59	1364.51	1413.68
	45"(1143mm)	42"(1067mm)	SYCJ-5042-L	1102.21	1156.72	1548.80	1603.31
	51"(1295mm)	48"(1219mm)	SYCJ-5048-L	1134.85	1194.70	1635.94	1695.79
	57"(1448mm)	54"(1372mm)	SYCJ-5054-L	1167.49	1232.68	1723.08	1788.27
	63"(1600mm)	60"(1524mm)	SYCJ-5060-L	1200.13	1270.66	1810.22	1880.75
	69"(1753mm)	66"(1676mm)	SYCJ-5066-L	1232.77	1308.64	1897.36	1973.23
	75"(1905mm)	72"(1829mm)	SYCJ-5072-L	1265.41	1346.62	1984.50	2065.71
	81"(2057mm)	78"(1981mm)	SYCJ-5078-L	1298.05	1384.60	2071.64	2158.19
	87"(2210mm)	84"(2134mm)	SYCJ-5084-L	1330.69	1422.58	2158.78	2250.67
	93"(2362mm)	90"(2286mm)	SYCJ-5090-L	1363.33	1460.56	2245.92	2343.15
	99"(2515mm)	96"(2438mm)	SYCJ-5096-L	1395.97	1498.54	2333.06	2435.63
	105"(2667mm)	102"(2591mm)	SYCJ-50A2-L	1428.61	1536.52	2420.20	2528.11
	111"(2819mm)	108"(2743mm)	SYCJ-50A8-L	1461.25	1574.50	2507.34	2620.59
	117"(2972mm)	114"(2896mm)	SYCJ-50B4-L	1493.89	1612.48	2594.48	2713.07
Gallery Panels 58"(1473mm)H							
58"(1473mm)	21"(533mm)	18"(457mm)	SYCJ-5818-L	\$ 781.22	\$ 824.53	\$ 1009.81	\$ 1053.12
	27"(686mm)	24"(610mm)	SYCJ-5824-L	813.86	862.51	1096.95	1145.60
	33"(838mm)	30"(762mm)	SYCJ-5830-L	846.50	900.49	1184.09	1238.08
	39"(991mm)	36"(914mm)	SYCJ-5836-L	1034.58	1093.91	1426.67	1486.00
	45"(1143mm)	42"(1067mm)	SYCJ-5842-L	1164.37	1229.04	1610.96	1675.63
	51"(1295mm)	48"(1219mm)	SYCJ-5848-L	1197.01	1267.02	1698.10	1768.11
	57"(1448mm)	54"(1372mm)	SYCJ-5854-L	1229.65	1305.00	1785.24	1860.59
	63"(1600mm)	60"(1524mm)	SYCJ-5860-L	1262.29	1342.98	1872.38	1953.07

Gallery Panel to Compose Beam Intermediate T (Two Sided Left/Right)

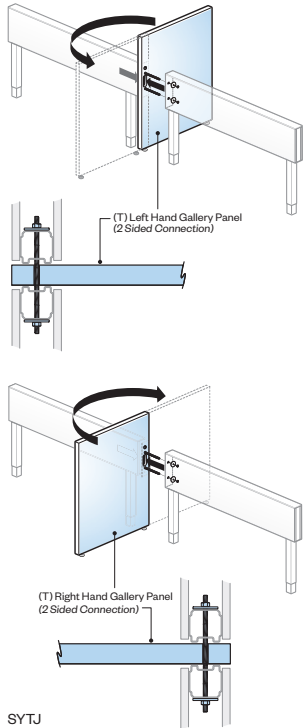

SYTJ

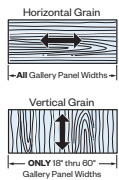

Class BC

Features

- Includes one pre-drilled, finished panel and attachment hardware.
- Gallery Panel is 1.18"(30mm) thick. Compose Beam adds 3"(76mm) to width.
- High Pressure Laminate (HPL) panel has 1mm edgeband.
- Glides provide 1.5"(38mm) level adjustment.
- Beam and hardware are field installed.
- Rail for glass ready option standard in black.
- Power pass through standard at below worksurface.

Specification Tips

- For intermediate use between two Compose Beams.
- Gallery Panels can be the same height or taller than the Beam.
- Gallery Panel has one face connection on both sides.
- Gallery Panel End attachment is not allowed on the same hand as the face attachment. Refer to the Specification Guide for End mounting application guidelines.
- Base power applications require separately specified Flexible Power Connector - Corner Span, Work-height (VZEF-OBOQ-).
- Specify No Glass option when using Glass Topper Holder Kit.
- "No Glass" Gallery Panels option cannot be retrofit to Glass Ready Option.
- Separately specify:
 - Insert Glass for Glass-Ready Gallery Panels
 - Glass Topper Holder Kit

To Order, Specify:

1) Product number, including:

1 Other End (Finished End or Connection End)

- N** No Connection (Finished End)
- A** 26"(660mm)H or 27"(686mm)H Connection
- B** 34"(864mm)H Connection
- C** 42"(1067mm)H Connection
- D** 50"(1270mm)H Connection
- E** 58"(1473mm)H Connection

2 Glass Options

- N** No Glass (Finished Top)
- G** Glass Ready

2) Laminate surface color.
3) Edgeband color.

Gallery Panel to Compose Beam Intermediate T (Two Sided Left/Right)

Nominal Height	Actual Width	Nominal Width	Number	①②	No Glass HPL		Glass Ready HPL	
					A	B	A	B
Gallery Panels 26"(660mm)H-34"(864mm)H								
26"(660mm)	21"(533mm)	18"(457mm)	SYTJ-2618-LN	■ ■	\$ 665.95	\$ 668.62	\$ 894.54	\$ 897.21
	27"(686mm)	24"(610mm)	SYTJ-2624-LN	■ ■	698.59	706.60	981.68	989.69
	33"(838mm)	30"(762mm)	SYTJ-2630-LN	■ ■	731.23	744.58	1068.82	1082.17
	39"(991mm)	36"(914mm)	SYTJ-2636-LN	■ ■	919.31	938.00	1311.40	1330.09
	45"(1143mm)	42"(1067mm)	SYTJ-2642-LN	■ ■	1049.10	1073.13	1495.69	1519.72
	51"(1295mm)	48"(1219mm)	SYTJ-2648-LN	■ ■	1081.74	1111.11	1582.83	1612.20
	57"(1448mm)	54"(1372mm)	SYTJ-2654-LN	■ ■	1114.38	1149.09	1669.97	1704.68
	63"(1600mm)	60"(1524mm)	SYTJ-2660-LN	■ ■	1147.02	1187.07	1757.11	1797.16
	69"(1753mm)	66"(1676mm)	SYTJ-2666-LN	■ ■	1179.66	1225.05	1844.25	1889.64
	75"(1905mm)	72"(1829mm)	SYTJ-2672-LN	■ ■	1212.30	1263.03	1931.39	1982.12
	81"(2057mm)	78"(1981mm)	SYTJ-2678-LN	■ ■	1244.94	1301.01	2018.53	2074.60
	87"(2210mm)	84"(2134mm)	SYTJ-2684-LN	■ ■	1277.58	1338.99	2105.67	2167.08
	93"(2362mm)	90"(2286mm)	SYTJ-2690-LN	■ ■	1310.22	1376.97	2192.81	2259.56
	99"(2515mm)	96"(2438mm)	SYTJ-2696-LN	■ ■	1342.86	1414.95	2279.95	2352.04
105"(2667mm)	102"(2591mm)	SYTJ-26A2-LN	■ ■	1375.50	1452.93	2367.09	2444.52	
111"(2819mm)	108"(2743mm)	SYTJ-26A8-LN	■ ■	1408.14	1490.91	2454.23	2537.00	
117"(2972mm)	114"(2896mm)	SYTJ-26B4-LN	■ ■	1440.78	1528.89	2541.37	2629.48	
27"(686mm)	21"(533mm)	18"(457mm)	SYTJ-2718-LN	■ ■	\$ 673.72	\$ 677.66	\$ 902.31	\$ 906.25
	27"(686mm)	24"(610mm)	SYTJ-2724-LN	■ ■	706.36	715.64	989.45	998.73
	33"(838mm)	30"(762mm)	SYTJ-2730-LN	■ ■	739.00	753.62	1076.59	1091.21
	39"(991mm)	36"(914mm)	SYTJ-2736-LN	■ ■	927.08	947.04	1319.17	1339.13
	45"(1143mm)	42"(1067mm)	SYTJ-2742-LN	■ ■	1056.87	1082.17	1503.46	1528.76
	51"(1295mm)	48"(1219mm)	SYTJ-2748-LN	■ ■	1089.51	1120.15	1590.60	1621.24
	57"(1448mm)	54"(1372mm)	SYTJ-2754-LN	■ ■	1122.15	1158.13	1677.74	1713.72
	63"(1600mm)	60"(1524mm)	SYTJ-2760-LN	■ ■	1154.79	1196.11	1764.88	1806.20
	69"(1753mm)	66"(1676mm)	SYTJ-2766-LN	■ ■	1187.43	1234.09	1852.02	1898.68
	75"(1905mm)	72"(1829mm)	SYTJ-2772-LN	■ ■	1220.07	1272.07	1939.16	1991.16
	81"(2057mm)	78"(1981mm)	SYTJ-2778-LN	■ ■	1252.71	1310.05	2026.30	2083.64
	87"(2210mm)	84"(2134mm)	SYTJ-2784-LN	■ ■	1285.35	1348.03	2113.44	2176.12
	93"(2362mm)	90"(2286mm)	SYTJ-2790-LN	■ ■	1317.99	1386.01	2200.58	2268.60
	99"(2515mm)	96"(2438mm)	SYTJ-2796-LN	■ ■	1350.63	1423.99	2287.72	2361.08
105"(2667mm)	102"(2591mm)	SYTJ-27A2-LN	■ ■	1383.27	1461.97	2374.86	2453.56	
111"(2819mm)	108"(2743mm)	SYTJ-27A8-LN	■ ■	1415.91	1499.95	2462.00	2546.04	
117"(2972mm)	114"(2896mm)	SYTJ-27B4-LN	■ ■	1448.55	1537.93	2549.14	2638.52	
34"(864mm)	21"(533mm)	18"(457mm)	SYTJ-3418-LN	■ ■	\$ 728.11	\$ 740.94	\$ 956.70	\$ 969.53
	27"(686mm)	24"(610mm)	SYTJ-3424-LN	■ ■	760.75	778.92	1043.84	1062.01
	33"(838mm)	30"(762mm)	SYTJ-3430-LN	■ ■	793.39	816.90	1130.98	1154.49
	39"(991mm)	36"(914mm)	SYTJ-3436-LN	■ ■	981.47	1010.32	1373.56	1402.41
	45"(1143mm)	42"(1067mm)	SYTJ-3442-LN	■ ■	1111.26	1145.45	1557.85	1592.04
	51"(1295mm)	48"(1219mm)	SYTJ-3448-LN	■ ■	1143.90	1183.43	1644.99	1684.52
	57"(1448mm)	54"(1372mm)	SYTJ-3454-LN	■ ■	1176.54	1221.41	1732.13	1777.00
	63"(1600mm)	60"(1524mm)	SYTJ-3460-LN	■ ■	1209.18	1259.39	1819.27	1869.48
	69"(1753mm)	66"(1676mm)	SYTJ-3466-LN	■ ■	1241.82	1297.37	1906.41	1961.96
	75"(1905mm)	72"(1829mm)	SYTJ-3472-LN	■ ■	1274.46	1335.35	1993.55	2054.44
	81"(2057mm)	78"(1981mm)	SYTJ-3478-LN	■ ■	1307.10	1373.33	2080.69	2146.92
	87"(2210mm)	84"(2134mm)	SYTJ-3484-LN	■ ■	1339.74	1411.31	2167.83	2239.40
	93"(2362mm)	90"(2286mm)	SYTJ-3490-LN	■ ■	1372.38	1449.29	2254.97	2331.88
	99"(2515mm)	96"(2438mm)	SYTJ-3496-LN	■ ■	1405.02	1487.27	2342.11	2424.36
105"(2667mm)	102"(2591mm)	SYTJ-34A2-LN	■ ■	1437.66	1525.25	2429.25	2516.84	
111"(2819mm)	108"(2743mm)	SYTJ-34A8-LN	■ ■	1470.30	1563.23	2516.39	2609.32	
117"(2972mm)	114"(2896mm)	SYTJ-34B4-LN	■ ■	1502.94	1601.21	2603.53	2701.80	

Gallery Panel to Compose Beam Intermediate T (Two Sided Left/Right)

Nominal Height	Actual Width	Nominal Width	Number	①②	No Glass HPL		Glass Ready HPL	
					A	B	A	B
Gallery Panels 42"(1067mm)H-50"(1270mm)H								
42"(1067mm)	21"(533mm)	18"(457mm)	SYTJ-4218-LN	■ ■	\$ 790.27	\$ 813.26	\$ 1018.86	\$ 1041.85
	27"(686mm)	24"(610mm)	SYTJ-4224-LN	■ ■	822.91	851.24	1106.00	1134.33
	33"(838mm)	30"(762mm)	SYTJ-4230-LN	■ ■	855.55	889.22	1193.14	1226.81
	39"(991mm)	36"(914mm)	SYTJ-4236-LN	■ ■	1043.63	1082.64	1435.72	1474.73
	45"(1143mm)	42"(1067mm)	SYTJ-4242-LN	■ ■	1173.42	1217.77	1620.01	1664.36
	51"(1295mm)	48"(1219mm)	SYTJ-4248-LN	■ ■	1206.06	1255.75	1707.15	1756.84
	57"(1448mm)	54"(1372mm)	SYTJ-4254-LN	■ ■	1238.70	1293.73	1794.29	1849.32
	63"(1600mm)	60"(1524mm)	SYTJ-4260-LN	■ ■	1271.34	1331.71	1881.43	1941.80
	69"(1753mm)	66"(1676mm)	SYTJ-4266-LN	■ ■	1303.98	1369.69	1968.57	2034.28
	75"(1905mm)	72"(1829mm)	SYTJ-4272-LN	■ ■	1336.62	1407.67	2055.71	2126.76
	81"(2057mm)	78"(1981mm)	SYTJ-4278-LN	■ ■	1369.26	1445.65	2142.85	2219.24
	87"(2210mm)	84"(2134mm)	SYTJ-4284-LN	■ ■	1401.90	1483.63	2229.99	2311.72
	93"(2362mm)	90"(2286mm)	SYTJ-4290-LN	■ ■	1434.54	1521.61	2317.13	2404.20
	99"(2515mm)	96"(2438mm)	SYTJ-4296-LN	■ ■	1467.18	1559.59	2404.27	2496.68
	105"(2667mm)	102"(2591mm)	SYTJ-42A2-LN	■ ■	1499.82	1597.57	2491.41	2589.16
	111"(2819mm)	108"(2743mm)	SYTJ-42A8-LN	■ ■	1532.46	1635.55	2578.55	2681.64
	117"(2972mm)	114"(2896mm)	SYTJ-42B4-LN	■ ■	1565.10	1673.53	2665.69	2774.12
50"(1270mm)	21"(533mm)	18"(457mm)	SYTJ-5018-LN	■ ■	\$ 852.43	\$ 885.58	\$ 1081.02	\$ 1114.17
	27"(686mm)	24"(610mm)	SYTJ-5024-LN	■ ■	885.07	923.56	1168.16	1206.65
	33"(838mm)	30"(762mm)	SYTJ-5030-LN	■ ■	917.71	961.54	1255.30	1299.13
	39"(991mm)	36"(914mm)	SYTJ-5036-LN	■ ■	1105.79	1154.96	1497.88	1547.05
	45"(1143mm)	42"(1067mm)	SYTJ-5042-LN	■ ■	1235.58	1290.09	1682.17	1736.68
	51"(1295mm)	48"(1219mm)	SYTJ-5048-LN	■ ■	1268.22	1328.07	1769.31	1829.16
	57"(1448mm)	54"(1372mm)	SYTJ-5054-LN	■ ■	1300.86	1366.05	1856.45	1921.64
	63"(1600mm)	60"(1524mm)	SYTJ-5060-LN	■ ■	1333.50	1404.03	1943.59	2014.12
	69"(1753mm)	66"(1676mm)	SYTJ-5066-LN	■ ■	1366.14	1442.01	2030.73	2106.60
	75"(1905mm)	72"(1829mm)	SYTJ-5072-LN	■ ■	1398.78	1479.99	2117.87	2199.08
	81"(2057mm)	78"(1981mm)	SYTJ-5078-LN	■ ■	1431.42	1517.97	2205.01	2291.56
	87"(2210mm)	84"(2134mm)	SYTJ-5084-LN	■ ■	1464.06	1555.95	2292.15	2384.04
	93"(2362mm)	90"(2286mm)	SYTJ-5090-LN	■ ■	1496.70	1593.93	2379.29	2476.52
	99"(2515mm)	96"(2438mm)	SYTJ-5096-LN	■ ■	1529.34	1631.91	2466.43	2569.00
	105"(2667mm)	102"(2591mm)	SYTJ-50A2-LN	■ ■	1561.98	1669.89	2553.57	2661.48
	111"(2819mm)	108"(2743mm)	SYTJ-50A8-LN	■ ■	1594.62	1707.87	2640.71	2753.96
	117"(2972mm)	114"(2896mm)	SYTJ-50B4-LN	■ ■	1627.26	1745.85	2727.85	2846.44
Gallery Panels 58"(1473mm)H								
58"(1473mm)	21"(533mm)	18"(457mm)	SYTJ-5818-LN	■ ■	\$ 914.59	\$ 957.90	\$ 1143.18	\$ 1186.49
	27"(686mm)	24"(610mm)	SYTJ-5824-LN	■ ■	947.23	995.88	1230.32	1278.97
	33"(838mm)	30"(762mm)	SYTJ-5830-LN	■ ■	979.87	1033.86	1317.46	1371.45
	39"(991mm)	36"(914mm)	SYTJ-5836-LN	■ ■	1167.95	1227.28	1560.04	1619.37
	45"(1143mm)	42"(1067mm)	SYTJ-5842-LN	■ ■	1297.74	1362.41	1744.33	1809.00
	51"(1295mm)	48"(1219mm)	SYTJ-5848-LN	■ ■	1330.38	1400.39	1831.47	1901.48
	57"(1448mm)	54"(1372mm)	SYTJ-5854-LN	■ ■	1363.02	1438.37	1918.61	1993.96
	63"(1600mm)	60"(1524mm)	SYTJ-5860-LN	■ ■	1395.66	1476.35	2005.75	2086.44

Gallery Panel to Compose Beam Intermediate H (Two Sided Half Left/Right)

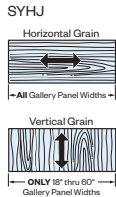
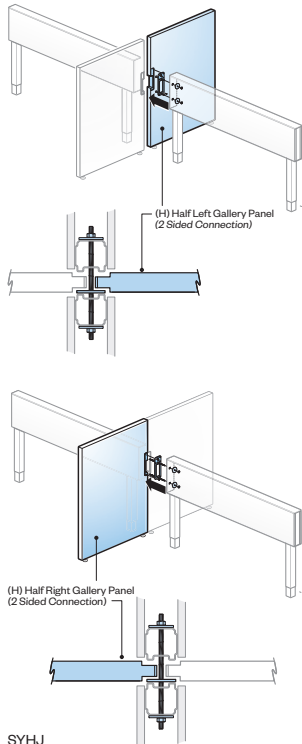

Class BC

Features

- Includes one pre-drilled, finished panel and attachment hardware.
- Attachment hardware includes one flat bracket to install on one side of the Gallery Panel.
- Gallery Panel is 1.18"(30mm) thick. Half Compose Beam adds 1.5"(38mm) to width.
- High Pressure Laminate (HPL) panel has 1mm edgeband.
- Glides provide 1.5"(38mm) level adjustment.
- Beam and hardware are field installed.
- Rail for glass ready option standard in black.
- Power pass through standard at below worksurface.

Specification Tips

- Two (H) Half Intermediate Gallery Panels are required for this application. Gallery Panel heights must match, widths may be different.
- For intermediate use between two Compose Beams.
- Gallery Panels can be the same height or taller than the Beam.
- Gallery Panel End attachment is not allowed on the same hand as the face attachment. Refer to the Specification Guide for End mounting application guidelines.
- Base power applications require separately specified Flexible Power Connector - Corner Span, Work-height (VZEF-OBOQ-).
- Specify No Glass option when using Glass Topper Holder Kit.
- "No Glass" Gallery Panels option cannot be retrofit to Glass Ready Option.
- Separately specify:
 - Insert Glass for Glass-Ready Gallery Panels
 - Glass Topper Holder Kit

To Order, Specify:

1) Product number, including:

1 Other End (Finished End or Connection End)

- N** No Connection (Finished End)
- A** 26"(660mm)H or 27"(686mm)H Connection
- B** 34"(864mm)H Connection
- C** 42"(1067mm)H Connection
- D** 50"(1270mm)H Connection
- E** 58"(1473mm)H Connection

2 Glass Options

- N** No Glass (Finished Top)
- G** Glass Ready

2) Laminate surface color.
3) Edgeband color.

Gallery Panel to Compose Beam Intermediate H (Two Sided Half Left/Right)

Nominal Height	Actual Width	Nominal Width	Number	①②	No Glass HPL		Glass Ready HPL	
					A	B	A	B
Gallery Panels 26"(660mm)H-34"(864mm)H								
26"(660mm)	19.5"(495mm)	18"(457mm)	SYHJ-2618-LN	■ ■	\$ 665.95	\$ 668.62	\$ 894.54	\$ 897.21
	25.5"(648mm)	24"(610mm)	SYHJ-2624-LN	■ ■	698.59	706.60	981.68	989.69
	31.5"(800mm)	30"(762mm)	SYHJ-2630-LN	■ ■	731.23	744.58	1068.82	1082.17
	37.5"(953mm)	36"(914mm)	SYHJ-2636-LN	■ ■	919.31	938.00	1311.40	1330.09
	43.5"(1105mm)	42"(1067mm)	SYHJ-2642-LN	■ ■	1049.10	1073.13	1495.69	1519.72
	49.5"(1257mm)	48"(1219mm)	SYHJ-2648-LN	■ ■	1081.74	1111.11	1582.83	1612.20
	55.5"(1410mm)	54"(1372mm)	SYHJ-2654-LN	■ ■	1114.38	1149.09	1669.97	1704.68
	61.5"(1562mm)	60"(1524mm)	SYHJ-2660-LN	■ ■	1147.02	1187.07	1757.11	1797.16
	67.5"(1715mm)	66"(1676mm)	SYHJ-2666-LN	■ ■	1179.66	1225.05	1844.25	1889.64
	73.5"(1867mm)	72"(1829mm)	SYHJ-2672-LN	■ ■	1212.30	1263.03	1931.39	1982.12
	79.5"(2019mm)	78"(1981mm)	SYHJ-2678-LN	■ ■	1244.94	1301.01	2018.53	2074.60
	85.5"(2172mm)	84"(2134mm)	SYHJ-2684-LN	■ ■	1277.58	1338.99	2105.67	2167.08
	91.5"(2324mm)	90"(2286mm)	SYHJ-2690-LN	■ ■	1310.22	1376.97	2192.81	2259.56
	97.5"(2477mm)	96"(2438mm)	SYHJ-2696-LN	■ ■	1342.86	1414.95	2279.95	2352.04
	103.5"(2629mm)	102"(2591mm)	SYHJ-26A2-LN	■ ■	1375.50	1452.93	2367.09	2444.52
	109.5"(2781mm)	108"(2743mm)	SYHJ-26A8-LN	■ ■	1408.14	1490.91	2454.23	2537.00
	115.5"(2934mm)	114"(2896mm)	SYHJ-26B4-LN	■ ■	1440.78	1528.89	2541.37	2629.48
27"(686mm)	19.5"(495mm)	18"(457mm)	SYHJ-2718-LN	■ ■	\$ 673.72	\$ 677.66	\$ 902.31	\$ 906.25
	25.5"(648mm)	24"(610mm)	SYHJ-2724-LN	■ ■	706.36	715.64	989.45	998.73
	31.5"(800mm)	30"(762mm)	SYHJ-2730-LN	■ ■	739.00	753.62	1076.59	1091.21
	37.5"(953mm)	36"(914mm)	SYHJ-2736-LN	■ ■	927.08	947.04	1319.17	1339.13
	43.5"(1105mm)	42"(1067mm)	SYHJ-2742-LN	■ ■	1056.87	1082.17	1503.46	1528.76
	49.5"(1257mm)	48"(1219mm)	SYHJ-2748-LN	■ ■	1089.51	1120.15	1590.60	1621.24
	55.5"(1410mm)	54"(1372mm)	SYHJ-2754-LN	■ ■	1122.15	1158.13	1677.74	1713.72
	61.5"(1562mm)	60"(1524mm)	SYHJ-2760-LN	■ ■	1154.79	1196.11	1764.88	1806.20
	67.5"(1715mm)	66"(1676mm)	SYHJ-2766-LN	■ ■	1187.43	1234.09	1852.02	1898.68
	73.5"(1867mm)	72"(1829mm)	SYHJ-2772-LN	■ ■	1220.07	1272.07	1939.16	1991.16
	79.5"(2019mm)	78"(1981mm)	SYHJ-2778-LN	■ ■	1252.71	1310.05	2026.30	2083.64
	85.5"(2172mm)	84"(2134mm)	SYHJ-2784-LN	■ ■	1285.35	1348.03	2113.44	2176.12
	91.5"(2324mm)	90"(2286mm)	SYHJ-2790-LN	■ ■	1317.99	1386.01	2200.58	2268.60
	97.5"(2477mm)	96"(2438mm)	SYHJ-2796-LN	■ ■	1350.63	1423.99	2287.72	2361.08
	103.5"(2629mm)	102"(2591mm)	SYHJ-27A2-LN	■ ■	1383.27	1461.97	2374.86	2453.56
	109.5"(2781mm)	108"(2743mm)	SYHJ-27A8-LN	■ ■	1415.91	1499.95	2462.00	2546.04
	115.5"(2934mm)	114"(2896mm)	SYHJ-27B4-LN	■ ■	1448.55	1537.93	2549.14	2638.52
34"(864mm)	19.5"(495mm)	18"(457mm)	SYHJ-3418-LN	■ ■	\$ 728.11	\$ 740.94	\$ 956.70	\$ 969.53
	25.5"(648mm)	24"(610mm)	SYHJ-3424-LN	■ ■	760.75	778.92	1043.84	1062.01
	31.5"(800mm)	30"(762mm)	SYHJ-3430-LN	■ ■	793.39	816.90	1130.98	1154.49
	37.5"(953mm)	36"(914mm)	SYHJ-3436-LN	■ ■	981.47	1010.32	1373.56	1402.41
	43.5"(1105mm)	42"(1067mm)	SYHJ-3442-LN	■ ■	1111.26	1145.45	1557.85	1592.04
	49.5"(1257mm)	48"(1219mm)	SYHJ-3448-LN	■ ■	1143.90	1183.43	1644.99	1684.52
	55.5"(1410mm)	54"(1372mm)	SYHJ-3454-LN	■ ■	1176.54	1221.41	1732.13	1777.00
	61.5"(1562mm)	60"(1524mm)	SYHJ-3460-LN	■ ■	1209.18	1259.39	1819.27	1869.48
	67.5"(1715mm)	66"(1676mm)	SYHJ-3466-LN	■ ■	1241.82	1297.37	1906.41	1961.96
	73.5"(1867mm)	72"(1829mm)	SYHJ-3472-LN	■ ■	1274.46	1335.35	1993.55	2054.44
	79.5"(2019mm)	78"(1981mm)	SYHJ-3478-LN	■ ■	1307.10	1373.33	2080.69	2146.92
	85.5"(2172mm)	84"(2134mm)	SYHJ-3484-LN	■ ■	1339.74	1411.31	2167.83	2239.40
	91.5"(2324mm)	90"(2286mm)	SYHJ-3490-LN	■ ■	1372.38	1449.29	2254.97	2331.88
	97.5"(2477mm)	96"(2438mm)	SYHJ-3496-LN	■ ■	1405.02	1487.27	2342.11	2424.36
	103.5"(2629mm)	102"(2591mm)	SYHJ-34A2-LN	■ ■	1437.66	1525.25	2429.25	2516.84
	109.5"(2781mm)	108"(2743mm)	SYHJ-34A8-LN	■ ■	1470.30	1563.23	2516.39	2609.32
	115.5"(2934mm)	114"(2896mm)	SYHJ-34B4-LN	■ ■	1502.94	1601.21	2603.53	2701.80

Gallery Panel to Compose Beam Intermediate H (Two Sided Half Left/Right)

Nominal Height	Actual Width	Nominal Width	Number	①②	No Glass HPL		Glass Ready HPL	
					A	B	A	B
Gallery Panels 42"(1067mm)H-50"(1270mm)H								
42"(1067mm)	19.5"(495mm)	18"(457mm)	SYHJ-4218-LN	■ ■	\$ 790.27	\$ 813.26	\$ 1018.86	\$ 1041.85
	25.5"(648mm)	24"(610mm)	SYHJ-4224-LN	■ ■	822.91	851.24	1106.00	1134.33
	31.5"(800mm)	30"(762mm)	SYHJ-4230-LN	■ ■	855.55	889.22	1193.14	1226.81
	37.5"(953mm)	36"(914mm)	SYHJ-4236-LN	■ ■	1043.63	1082.64	1435.72	1474.73
	43.5"(1105mm)	42"(1067mm)	SYHJ-4242-LN	■ ■	1173.42	1217.77	1620.01	1664.36
	49.5"(1257mm)	48"(1219mm)	SYHJ-4248-LN	■ ■	1206.06	1255.75	1707.15	1756.84
	55.5"(1410mm)	54"(1372mm)	SYHJ-4254-LN	■ ■	1238.70	1293.73	1794.29	1849.32
	61.5"(1562mm)	60"(1524mm)	SYHJ-4260-LN	■ ■	1271.34	1331.71	1881.43	1941.80
	67.5"(1715mm)	66"(1676mm)	SYHJ-4266-LN	■ ■	1303.98	1369.69	1968.57	2034.28
	73.5"(1867mm)	72"(1829mm)	SYHJ-4272-LN	■ ■	1336.62	1407.67	2055.71	2126.76
	79.5"(2019mm)	78"(1981mm)	SYHJ-4278-LN	■ ■	1369.26	1445.65	2142.85	2219.24
	85.5"(2172mm)	84"(2134mm)	SYHJ-4284-LN	■ ■	1401.90	1483.63	2229.99	2311.72
	91.5"(2324mm)	90"(2286mm)	SYHJ-4290-LN	■ ■	1434.54	1521.61	2317.13	2404.20
	97.5"(2477mm)	96"(2438mm)	SYHJ-4296-LN	■ ■	1467.18	1559.59	2404.27	2496.68
	103.5"(2629mm)	102"(2591mm)	SYHJ-42A2-LN	■ ■	1499.82	1597.57	2491.41	2589.16
	109.5"(2781mm)	108"(2743mm)	SYHJ-42A8-LN	■ ■	1532.46	1635.55	2578.55	2681.64
	115.5"(2934mm)	114"(2896mm)	SYHJ-42B4-LN	■ ■	1565.10	1673.53	2665.69	2774.12
50"(1270mm)	19.5"(495mm)	18"(457mm)	SYHJ-5018-LN	■ ■	\$ 852.43	\$ 885.58	\$ 1081.02	\$ 1114.17
	25.5"(648mm)	24"(610mm)	SYHJ-5024-LN	■ ■	885.07	923.56	1168.16	1206.65
	31.5"(800mm)	30"(762mm)	SYHJ-5030-LN	■ ■	917.71	961.54	1255.30	1299.13
	37.5"(953mm)	36"(914mm)	SYHJ-5036-LN	■ ■	1105.79	1154.96	1497.88	1547.05
	43.5"(1105mm)	42"(1067mm)	SYHJ-5042-LN	■ ■	1235.58	1290.09	1682.17	1736.68
	49.5"(1257mm)	48"(1219mm)	SYHJ-5048-LN	■ ■	1268.22	1328.07	1769.31	1829.16
	55.5"(1410mm)	54"(1372mm)	SYHJ-5054-LN	■ ■	1300.86	1366.05	1856.45	1921.64
	61.5"(1562mm)	60"(1524mm)	SYHJ-5060-LN	■ ■	1333.50	1404.03	1943.59	2014.12
	67.5"(1715mm)	66"(1676mm)	SYHJ-5066-LN	■ ■	1366.14	1442.01	2030.73	2106.60
	73.5"(1867mm)	72"(1829mm)	SYHJ-5072-LN	■ ■	1398.78	1479.99	2117.87	2199.08
	79.5"(2019mm)	78"(1981mm)	SYHJ-5078-LN	■ ■	1431.42	1517.97	2205.01	2291.56
	85.5"(2172mm)	84"(2134mm)	SYHJ-5084-LN	■ ■	1464.06	1555.95	2292.15	2384.04
	91.5"(2324mm)	90"(2286mm)	SYHJ-5090-LN	■ ■	1496.70	1593.93	2379.29	2476.52
	97.5"(2477mm)	96"(2438mm)	SYHJ-5096-LN	■ ■	1529.34	1631.91	2466.43	2569.00
	103.5"(2629mm)	102"(2591mm)	SYHJ-50A2-LN	■ ■	1561.98	1669.89	2553.57	2661.48
	109.5"(2781mm)	108"(2743mm)	SYHJ-50A8-LN	■ ■	1594.62	1707.87	2640.71	2753.96
	115.5"(2934mm)	114"(2896mm)	SYHJ-50B4-LN	■ ■	1627.26	1745.85	2727.85	2846.44
Gallery Panels 58"(1473mm)H								
58"(1473mm)	19.5"(495mm)	18"(457mm)	SYHJ-5818-LN	■ ■	\$ 914.59	\$ 957.90	\$ 1143.18	\$ 1186.49
	25.5"(648mm)	24"(610mm)	SYHJ-5824-LN	■ ■	947.23	995.88	1230.32	1278.97
	31.5"(800mm)	30"(762mm)	SYHJ-5830-LN	■ ■	979.87	1033.86	1317.46	1371.45
	37.5"(953mm)	36"(914mm)	SYHJ-5836-LN	■ ■	1167.95	1227.28	1560.04	1619.37
	43.5"(1105mm)	42"(1067mm)	SYHJ-5842-LN	■ ■	1297.74	1362.41	1744.33	1809.00
	49.5"(1257mm)	48"(1219mm)	SYHJ-5848-LN	■ ■	1330.38	1400.39	1831.47	1901.48
	55.5"(1410mm)	54"(1372mm)	SYHJ-5854-LN	■ ■	1363.02	1438.37	1918.61	1993.96
	61.5"(1562mm)	60"(1524mm)	SYHJ-5860-LN	■ ■	1395.66	1476.35	2005.75	2086.44

Gallery Panel to Compose Beam Intermediate X (Center - Two-Sided Mount)

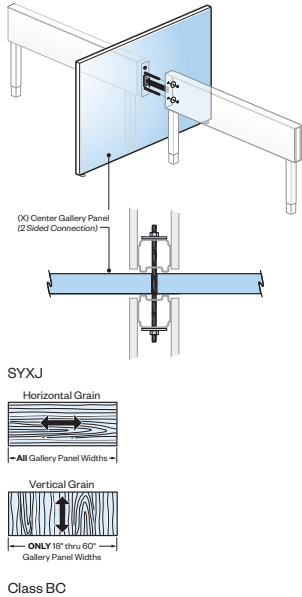

Class BC

Features

- Includes one pre-drilled, finished panel and attachment hardware.
- Gallery Panel is 1.18”(30mm) thick. Compose Beam adds 3”(76mm) to width.
- High Pressure Laminate (HPL) panel has 1mm edgeband.
- Glides provide 1.5”(38mm) level adjustment.
- Beam and hardware are field installed.
- Rail for glass ready option standard in black.
- Power pass through standard at below worksurface.

Specification Tips

- For in-line use between two Compose Beams.
- Gallery Panels can be the same height or taller than the Compose Beam.
- Gallery Panel has one center face connection both sides.
- Refer to the Specification Guide for Face and Beam End mounting application guidelines.
- Base power applications require separately specified Flexible Power Connector - Corner Span, Work-height (VZEF-0B0Q-).
- Specify No Glass option when using Glass Topper Holder Kit.
- “No Glass” Gallery Panels option cannot be retrofit to Glass Ready Option.
- Separately specify:
 - Insert Glass for Glass-Ready Gallery Panels
 - Glass Topper Holder Kit

To Order, Specify:

1) Product number, including:

1 First End (Finished End or Connection End)

- N** No Connection (Finished End)
- A** 26”(660mm)H or 27”(686mm)H Connection
- B** 34”(864mm)H Connection
- C** 42”(1067mm)H Connection
- D** 50”(1270mm)H Connection
- E** 58”(1473mm)H Connection

2 Other End (Finished End or Connection End)

- N** No Connection (Finished End)
- A** 26”(660mm)H or 27”(686mm)H Connection
- B** 34”(864mm)H Connection
- C** 42”(1067mm)H Connection
- D** 50”(1270mm)H Connection
- E** 58”(1473mm)H Connection

3 Glass Options

- N** No Glass (Finished Top)
- G** Glass Ready

2) Laminate surface color.
3) Edgeband

Gallery Panel to Compose Beam Intermediate X (Center - Two-Sided Mount)

Nominal Height	Actual Width	Nominal Width	Number ①②③	No Glass HPL		Glass Ready HPL	
				A	B	A	B
Gallery Panels 26"(660mm)H-34"(864mm)H							
26"(660mm)	21"(533mm)	18"(457mm)	SYXJ-2618-L	\$ 665.95	\$ 668.62	\$ 894.54	\$ 897.21
	27"(686mm)	24"(610mm)	SYXJ-2624-L	698.59	706.60	981.68	989.69
	33"(838mm)	30"(762mm)	SYXJ-2630-L	731.23	744.58	1068.82	1082.17
	39"(991mm)	36"(914mm)	SYXJ-2636-L	919.31	938.00	1311.40	1330.09
	45"(1143mm)	42"(1067mm)	SYXJ-2642-L	1049.10	1073.13	1495.69	1519.72
	51"(1295mm)	48"(1219mm)	SYXJ-2648-L	1081.74	1111.11	1582.83	1612.20
	57"(1448mm)	54"(1372mm)	SYXJ-2654-L	1114.38	1149.09	1669.97	1704.68
	63"(1600mm)	60"(1524mm)	SYXJ-2660-L	1147.02	1187.07	1757.11	1797.16
	69"(1753mm)	66"(1676mm)	SYXJ-2666-L	1179.66	1225.05	1844.25	1889.64
	75"(1905mm)	72"(1829mm)	SYXJ-2672-L	1212.30	1263.03	1931.39	1982.12
	81"(2057mm)	78"(1981mm)	SYXJ-2678-L	1244.94	1301.01	2018.53	2074.60
	87"(2210mm)	84"(2134mm)	SYXJ-2684-L	1277.58	1338.99	2105.67	2167.08
	93"(2362mm)	90"(2286mm)	SYXJ-2690-L	1310.22	1376.97	2192.81	2259.56
	99"(2515mm)	96"(2438mm)	SYXJ-2696-L	1342.86	1414.95	2279.95	2352.04
105"(2667mm)	102"(2591mm)	SYXJ-26A2-L	1375.50	1452.93	2367.09	2444.52	
111"(2819mm)	108"(2743mm)	SYXJ-26A8-L	1408.14	1490.91	2454.23	2537.00	
117"(2972mm)	114"(2896mm)	SYXJ-26B4-L	1440.78	1528.89	2541.37	2629.48	
27"(686mm)	21"(533mm)	18"(457mm)	SYXJ-2718-L	\$ 673.72	\$ 677.66	\$ 902.31	\$ 906.25
	27"(686mm)	24"(610mm)	SYXJ-2724-L	706.36	715.64	989.45	998.73
	33"(838mm)	30"(762mm)	SYXJ-2730-L	739.00	753.62	1076.59	1091.21
	39"(991mm)	36"(914mm)	SYXJ-2736-L	927.08	947.04	1319.17	1339.13
	45"(1143mm)	42"(1067mm)	SYXJ-2742-L	1056.87	1082.17	1503.46	1528.76
	51"(1295mm)	48"(1219mm)	SYXJ-2748-L	1089.51	1120.15	1590.60	1621.24
	57"(1448mm)	54"(1372mm)	SYXJ-2754-L	1122.15	1158.13	1677.74	1713.72
	63"(1600mm)	60"(1524mm)	SYXJ-2760-L	1154.79	1196.11	1764.88	1806.20
	69"(1753mm)	66"(1676mm)	SYXJ-2766-L	1187.43	1234.09	1852.02	1898.68
	75"(1905mm)	72"(1829mm)	SYXJ-2772-L	1220.07	1272.07	1939.16	1991.16
	81"(2057mm)	78"(1981mm)	SYXJ-2778-L	1252.71	1310.05	2026.30	2083.64
	87"(2210mm)	84"(2134mm)	SYXJ-2784-L	1285.35	1348.03	2113.44	2176.12
	93"(2362mm)	90"(2286mm)	SYXJ-2790-L	1317.99	1386.01	2200.58	2268.60
	99"(2515mm)	96"(2438mm)	SYXJ-2796-L	1350.63	1423.99	2287.72	2361.08
105"(2667mm)	102"(2591mm)	SYXJ-27A2-L	1383.27	1461.97	2374.86	2453.56	
111"(2819mm)	108"(2743mm)	SYXJ-27A8-L	1415.91	1499.95	2462.00	2546.04	
117"(2972mm)	114"(2896mm)	SYXJ-27B4-L	1448.55	1537.93	2549.14	2638.52	
34"(864mm)	21"(533mm)	18"(457mm)	SYXJ-3418-L	\$ 728.11	\$ 740.94	\$ 956.70	\$ 969.53
	27"(686mm)	24"(610mm)	SYXJ-3424-L	760.75	778.92	1043.84	1062.01
	33"(838mm)	30"(762mm)	SYXJ-3430-L	793.39	816.90	1130.98	1154.49
	39"(991mm)	36"(914mm)	SYXJ-3436-L	981.47	1010.32	1373.56	1402.41
	45"(1143mm)	42"(1067mm)	SYXJ-3442-L	1111.26	1145.45	1557.85	1592.04
	51"(1295mm)	48"(1219mm)	SYXJ-3448-L	1143.90	1183.43	1644.99	1684.52
	57"(1448mm)	54"(1372mm)	SYXJ-3454-L	1176.54	1221.41	1732.13	1777.00
	63"(1600mm)	60"(1524mm)	SYXJ-3460-L	1209.18	1259.39	1819.27	1869.48
	69"(1753mm)	66"(1676mm)	SYXJ-3466-L	1241.82	1297.37	1906.41	1961.96
	75"(1905mm)	72"(1829mm)	SYXJ-3472-L	1274.46	1335.35	1993.55	2054.44
	81"(2057mm)	78"(1981mm)	SYXJ-3478-L	1307.10	1373.33	2080.69	2146.92
	87"(2210mm)	84"(2134mm)	SYXJ-3484-L	1339.74	1411.31	2167.83	2239.40
	93"(2362mm)	90"(2286mm)	SYXJ-3490-L	1372.38	1449.29	2254.97	2331.88
	99"(2515mm)	96"(2438mm)	SYXJ-3496-L	1405.02	1487.27	2342.11	2424.36
105"(2667mm)	102"(2591mm)	SYXJ-34A2-L	1437.66	1525.25	2429.25	2516.84	
111"(2819mm)	108"(2743mm)	SYXJ-34A8-L	1470.30	1563.23	2516.39	2609.32	
117"(2972mm)	114"(2896mm)	SYXJ-34B4-L	1502.94	1601.21	2603.53	2701.80	

Gallery Panel to Compose Beam Intermediate X (Center - Two-Sided Mount)

Nominal Height	Actual Width	Nominal Width	Number ①②③	No Glass HPL		Glass Ready HPL	
				A	B	A	B
Gallery Panels 42"(1067mm)H-50"(1270mm)H							
42"(1067mm)	21"(533mm)	18"(457mm)	SYXJ-4218-L	\$ 790.27	\$ 813.26	\$ 1018.86	\$ 1041.85
	27"(686mm)	24"(610mm)	SYXJ-4224-L	822.91	851.24	1106.00	1134.33
	33"(838mm)	30"(762mm)	SYXJ-4230-L	855.55	889.22	1193.14	1226.81
	39"(991mm)	36"(914mm)	SYXJ-4236-L	1043.63	1082.64	1435.72	1474.73
	45"(1143mm)	42"(1067mm)	SYXJ-4242-L	1173.42	1217.77	1620.01	1664.36
	51"(1295mm)	48"(1219mm)	SYXJ-4248-L	1206.06	1255.75	1707.15	1756.84
	57"(1448mm)	54"(1372mm)	SYXJ-4254-L	1238.70	1293.73	1794.29	1849.32
	63"(1600mm)	60"(1524mm)	SYXJ-4260-L	1271.34	1331.71	1881.43	1941.80
	69"(1753mm)	66"(1676mm)	SYXJ-4266-L	1303.98	1369.69	1968.57	2034.28
	75"(1905mm)	72"(1829mm)	SYXJ-4272-L	1336.62	1407.67	2055.71	2126.76
	81"(2057mm)	78"(1981mm)	SYXJ-4278-L	1369.26	1445.65	2142.85	2219.24
	87"(2210mm)	84"(2134mm)	SYXJ-4284-L	1401.90	1483.63	2229.99	2311.72
	93"(2362mm)	90"(2286mm)	SYXJ-4290-L	1434.54	1521.61	2317.13	2404.20
	99"(2515mm)	96"(2438mm)	SYXJ-4296-L	1467.18	1559.59	2404.27	2496.68
	105"(2667mm)	102"(2591mm)	SYXJ-42A2-L	1499.82	1597.57	2491.41	2589.16
	111"(2819mm)	108"(2743mm)	SYXJ-42A8-L	1532.46	1635.55	2578.55	2681.64
	117"(2972mm)	114"(2896mm)	SYXJ-42B4-L	1565.10	1673.53	2665.69	2774.12
50"(1270mm)							
	21"(533mm)	18"(457mm)	SYXJ-5018-L	\$ 852.43	\$ 885.58	\$ 1081.02	\$ 1114.17
	27"(686mm)	24"(610mm)	SYXJ-5024-L	885.07	923.56	1168.16	1206.65
	33"(838mm)	30"(762mm)	SYXJ-5030-L	917.71	961.54	1255.30	1299.13
	39"(991mm)	36"(914mm)	SYXJ-5036-L	1105.79	1154.96	1497.88	1547.05
	45"(1143mm)	42"(1067mm)	SYXJ-5042-L	1235.58	1290.09	1682.17	1736.68
	51"(1295mm)	48"(1219mm)	SYXJ-5048-L	1268.22	1328.07	1769.31	1829.16
	57"(1448mm)	54"(1372mm)	SYXJ-5054-L	1300.86	1366.05	1856.45	1921.64
	63"(1600mm)	60"(1524mm)	SYXJ-5060-L	1333.50	1404.03	1943.59	2014.12
	69"(1753mm)	66"(1676mm)	SYXJ-5066-L	1366.14	1442.01	2030.73	2106.60
	75"(1905mm)	72"(1829mm)	SYXJ-5072-L	1398.78	1479.99	2117.87	2199.08
	81"(2057mm)	78"(1981mm)	SYXJ-5078-L	1431.42	1517.97	2205.01	2291.56
	87"(2210mm)	84"(2134mm)	SYXJ-5084-L	1464.06	1555.95	2292.15	2384.04
	93"(2362mm)	90"(2286mm)	SYXJ-5090-L	1496.70	1593.93	2379.29	2476.52
	99"(2515mm)	96"(2438mm)	SYXJ-5096-L	1529.34	1631.91	2466.43	2569.00
	105"(2667mm)	102"(2591mm)	SYXJ-50A2-L	1561.98	1669.89	2553.57	2661.48
	111"(2819mm)	108"(2743mm)	SYXJ-50A8-L	1594.62	1707.87	2640.71	2753.96
	117"(2972mm)	114"(2896mm)	SYXJ-50B4-L	1627.26	1745.85	2727.85	2846.44
Gallery Panels 58"(1473mm)H							
58"(1473mm)	21"(533mm)	18"(457mm)	SYXJ-5818-L	\$ 914.59	\$ 957.90	\$ 1143.18	\$ 1186.49
	27"(686mm)	24"(610mm)	SYXJ-5824-L	947.23	995.88	1230.32	1278.97
	33"(838mm)	30"(762mm)	SYXJ-5830-L	979.87	1033.86	1317.46	1371.45
	39"(991mm)	36"(914mm)	SYXJ-5836-L	1167.95	1227.28	1560.04	1619.37
	45"(1143mm)	42"(1067mm)	SYXJ-5842-L	1297.74	1362.41	1744.33	1809.00
	51"(1295mm)	48"(1219mm)	SYXJ-5848-L	1330.38	1400.39	1831.47	1901.48
	57"(1448mm)	54"(1372mm)	SYXJ-5854-L	1363.02	1438.37	1918.61	1993.96
	63"(1600mm)	60"(1524mm)	SYXJ-5860-L	1395.66	1476.35	2005.75	2086.44

Gallery Panel to Gallery Panel Face Attachment

L/R (Left or Right Mount)

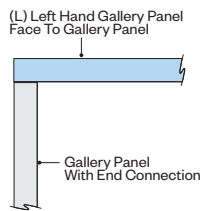
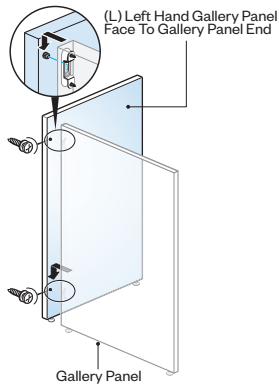

SYLD (Left Face)

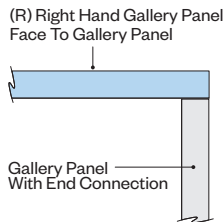
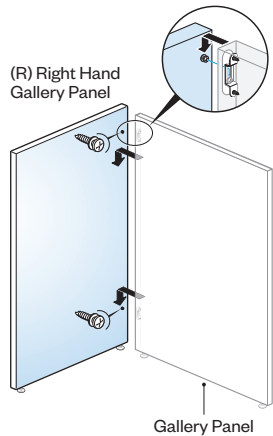

SYRD (Right Face)

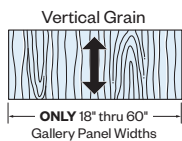
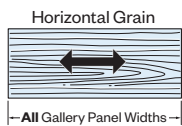

Class BC

Features

- Includes one pre-drilled, finished panel and attachment hardware.
- Gallery Panel is 1.18"(30mm) thick. Additional Gallery Panel adds 1.18"(30mm) to width.
- High Pressure Laminate (HPL) panel has 1mm edgeband.
- Glides provide 1.5"(38mm) level adjustment.
- Panel and hardware are field installed.
- Rail for glass ready option standard in black.
- Handedness is determined by Face Connection.

Specification Tips

- Designed to connect to other Compose Gallery Panels on the Face and/or Ends.
- Connecting Compose Gallery Panels may be shorter, the same height or taller than each other. For each connection:
 - If Gallery Panels are different heights, select the connection height of the shortest Gallery Panel.
 - If Gallery Panels are the same height, select this connection height.
 - Gallery Panel End attachment is not allowed on the same hand as the face attachment. Refer to the Specification Guide for Face and End mounting application guidelines.
- Gallery Panel has one face connection only; select RH or LH.
- Must separately specify two (one each side) Tie Plates (ZBBP-0000-PN) to secure End-to-End Gallery Panels in 180° conditions. Required at each End-to-End connection. Tie Plates are not required for Post Connection Option.
- Specify No Glass option when using Glass Topper Holder Kit.
- "No Glass" Gallery Panels option cannot be retrofit to Glass Ready Option.
- Separately specify:
 - Insert Glass for Glass-Ready Gallery Panels
 - Glass Topper Holder Kit

To Order, Specify:

1) Product number, including:

1 Face Handed Connection

- L** Left Face
- R** Right Face

2 Face Connection Height

- A** 26"(660mm)H or 27"(686mm)H Connection
- B** 34"(864mm)H Connection
- C** 42"(1067mm)H Connection
- D** 50"(1270mm)H Connection
- E** 58"(1473mm)H Connection

3 Left End (Finished End or Connection End)

- N** No Connection (Finished End)
- A** 26"(660mm)H or 27"(686mm)H Connection (not available for Left-Hand orientation)
- B** 34"(864mm)H Connection (not available for Left-Hand orientation)
- C** 42"(1067mm)H Connection (not available for Left-Hand orientation)
- D** 50"(1270mm)H Connection (not available for Left-Hand orientation)
- E** 58"(1473mm)H Connection (not available for Left-Hand orientation)

4 Right End (Finished End or Connection End)

- N** No Connection (Finished End)
- A** 26"(660mm)H or 27"(686mm)H Connection (not available for Right-Hand orientation)
- B** 34"(864mm)H Connection (not available for Right-Hand orientation)
- C** 42"(1067mm)H Connection (not available for Right-Hand orientation)
- D** 50"(1270mm)H Connection (not available for Right-Hand orientation)
- E** 58"(1473mm)H Connection (not available for Right-Hand orientation)

5 Glass Options

- N** No Glass (Finished Top)
- G** Glass Ready

2) Laminate surface color.

3) Edgeband color.

Gallery Panel to Gallery Panel Face Attachment

L/R (Left or Right Mount)

Nominal Height	Actual Width	Nominal Width	Number		No Glass HPL		Glass Ready HPL	
			①②	③④⑤	A	B	A	B
Gallery Panels 26"(660mm)H-34"(864mm)H								
26"(660mm)	19.8"(503mm)	18"(457mm)	SY	A-2618-L	\$ 484.71	\$ 487.38	\$ 713.30	\$ 715.97
	25.8"(655mm)	24"(610mm)	SY	A-2624-L	517.35	525.36	800.44	808.45
	31.8"(808mm)	30"(762mm)	SY	A-2630-L	549.99	563.34	887.58	900.93
	37.8"(960mm)	36"(914mm)	SY	A-2636-L	738.07	756.76	1130.16	1148.85
	43.8"(1113mm)	42"(1067mm)	SY	A-2642-L	867.86	891.89	1314.45	1338.48
	49.8"(1265mm)	48"(1219mm)	SY	A-2648-L	900.50	929.87	1401.59	1430.96
	45.8"(1163mm)	54"(1372mm)	SY	A-2654-L	933.14	967.85	1488.73	1523.44
	61.8"(1570mm)	60"(1524mm)	SY	A-2660-L	965.78	1005.83	1575.87	1615.92
	67.8"(1722mm)	66"(1676mm)	SY	A-2666-L	998.42	1043.81	1663.01	1708.40
	73.8"(1875mm)	72"(1829mm)	SY	A-2672-L	1031.06	1081.79	1750.15	1800.88
	79.8"(2027mm)	78"(1981mm)	SY	A-2678-L	1063.70	1119.77	1837.29	1893.36
	85.8"(2179mm)	84"(2134mm)	SY	A-2684-L	1096.34	1157.75	1924.43	1985.84
	91.8"(2332mm)	90"(2286mm)	SY	A-2690-L	1128.98	1195.73	2011.57	2078.32
	97.8"(2484mm)	96"(2438mm)	SY	A-2696-L	1161.62	1233.71	2098.71	2170.80
	103.8"(2637mm)	102"(2591mm)	SY	A-26A2-L	1194.26	1271.69	2185.85	2263.28
	109.8"(2789mm)	108"(2743mm)	SY	A-26A8-L	1226.90	1309.67	2272.99	2355.76
	115.8"(2941mm)	114"(2896mm)	SY	A-26B4-L	1259.54	1347.65	2360.13	2448.24
27"(686mm)	19.8"(503mm)	18"(457mm)	SY	A-2718-L	\$ 492.48	\$ 496.42	\$ 721.07	\$ 725.01
	25.8"(655mm)	24"(610mm)	SY	A-2724-L	525.12	534.40	808.21	817.49
	31.8"(808mm)	30"(762mm)	SY	A-2730-L	557.76	572.38	895.35	909.97
	37.8"(960mm)	36"(914mm)	SY	A-2736-L	745.84	765.80	1137.93	1157.89
	43.8"(1113mm)	42"(1067mm)	SY	A-2742-L	875.63	900.93	1322.22	1347.52
	49.8"(1265mm)	48"(1219mm)	SY	A-2748-L	908.27	938.91	1409.36	1440.00
	45.8"(1163mm)	54"(1372mm)	SY	A-2754-L	940.91	976.89	1496.50	1532.48
	61.8"(1570mm)	60"(1524mm)	SY	A-2760-L	973.55	1014.87	1583.64	1624.96
	67.8"(1722mm)	66"(1676mm)	SY	A-2766-L	1006.19	1052.85	1670.78	1717.44
	73.8"(1875mm)	72"(1829mm)	SY	A-2772-L	1038.83	1090.83	1757.92	1809.92
	79.8"(2027mm)	78"(1981mm)	SY	A-2778-L	1071.47	1128.81	1845.06	1902.40
	85.8"(2179mm)	84"(2134mm)	SY	A-2784-L	1104.11	1166.79	1932.20	1994.88
	91.8"(2332mm)	90"(2286mm)	SY	A-2790-L	1136.75	1204.77	2019.34	2087.36
	97.8"(2484mm)	96"(2438mm)	SY	A-2796-L	1169.39	1242.75	2106.48	2179.84
	103.8"(2637mm)	102"(2591mm)	SY	A-27A2-L	1202.03	1280.73	2193.62	2272.32
	109.8"(2789mm)	108"(2743mm)	SY	A-27A8-L	1234.67	1318.71	2280.76	2364.80
	115.8"(2941mm)	114"(2896mm)	SY	A-27B4-L	1267.31	1356.69	2367.90	2457.28
34"(864mm)	19.8"(503mm)	18"(457mm)	SY	-3418-L	\$ 546.87	\$ 559.70	\$ 775.46	\$ 788.29
	25.8"(655mm)	24"(610mm)	SY	-3424-L	579.51	597.68	862.60	880.77
	31.8"(808mm)	30"(762mm)	SY	-3430-L	612.15	635.66	949.74	973.25
	37.8"(960mm)	36"(914mm)	SY	-3436-L	800.23	829.08	1192.32	1221.17
	43.8"(1113mm)	42"(1067mm)	SY	-3442-L	930.02	964.21	1376.61	1410.80
	49.8"(1265mm)	48"(1219mm)	SY	-3448-L	962.66	1002.19	1463.75	1503.28
	45.8"(1163mm)	54"(1372mm)	SY	-3454-L	995.30	1040.17	1550.89	1595.76
	61.8"(1570mm)	60"(1524mm)	SY	-3460-L	1027.94	1078.15	1638.03	1688.24
	67.8"(1722mm)	66"(1676mm)	SY	-3466-L	1060.58	1116.13	1725.17	1780.72
	73.8"(1875mm)	72"(1829mm)	SY	-3472-L	1093.22	1154.11	1812.31	1873.20
	79.8"(2027mm)	78"(1981mm)	SY	-3478-L	1125.86	1192.09	1899.45	1965.68
	85.8"(2179mm)	84"(2134mm)	SY	-3484-L	1158.50	1230.07	1986.59	2058.16
	91.8"(2332mm)	90"(2286mm)	SY	-3490-L	1191.14	1268.05	2073.73	2150.64
	97.8"(2484mm)	96"(2438mm)	SY	-3496-L	1223.78	1306.03	2160.87	2243.12
	103.8"(2637mm)	102"(2591mm)	SY	-34A2-L	1256.42	1344.01	2248.01	2335.60
	109.8"(2789mm)	108"(2743mm)	SY	-34A8-L	1289.06	1381.99	2335.15	2428.08
	115.8"(2941mm)	114"(2896mm)	SY	-34B4-L	1321.70	1419.97	2422.29	2520.56

Gallery Panel to Gallery Panel Face Attachment

L/R (Left or Right Mount)

Nominal Height	Actual Width	Nominal Width	Number		No Glass HPL		Glass Ready HPL	
			①②	③④⑤	A	B	A	B
Gallery Panels 42"(1067mm)H-50"(1270mm)H								
42"(1067mm)	19.8"(503mm)	18"(457mm)	SY ■■■ -4218-L ■■■■		\$ 609.03	\$ 632.02	\$ 837.62	\$ 860.61
	25.8"(655mm)	24"(610mm)	SY ■■■ -4224-L ■■■■		641.67	670.00	924.76	953.09
	31.8"(808mm)	30"(762mm)	SY ■■■ -4230-L ■■■■		674.31	707.98	1011.90	1045.57
	37.8"(960mm)	36"(914mm)	SY ■■■ -4236-L ■■■■		862.39	901.40	1254.48	1293.49
	43.8"(1113mm)	42"(1067mm)	SY ■■■ -4242-L ■■■■		992.18	1036.53	1438.77	1483.12
	49.8"(1265mm)	48"(1219mm)	SY ■■■ -4248-L ■■■■		1024.82	1074.51	1525.91	1575.60
	45.8"(1163mm)	54"(1372mm)	SY ■■■ -4254-L ■■■■		1057.46	1112.49	1613.05	1668.08
	61.8"(1570mm)	60"(1524mm)	SY ■■■ -4260-L ■■■■		1090.10	1150.47	1700.19	1760.56
	67.8"(1722mm)	66"(1676mm)	SY ■■■ -4266-L ■■■■		1122.74	1188.45	1787.33	1853.04
	73.8"(1875mm)	72"(1829mm)	SY ■■■ -4272-L ■■■■		1155.38	1226.43	1874.47	1945.52
	79.8"(2027mm)	78"(1981mm)	SY ■■■ -4278-L ■■■■		1188.02	1264.41	1961.61	2038.00
	85.8"(2179mm)	84"(2134mm)	SY ■■■ -4284-L ■■■■		1220.66	1302.39	2048.75	2130.48
	91.8"(2332mm)	90"(2286mm)	SY ■■■ -4290-L ■■■■		1253.30	1340.37	2135.89	2222.96
	97.8"(2484mm)	96"(2438mm)	SY ■■■ -4296-L ■■■■		1285.94	1378.35	2223.03	2315.44
	103.8"(2637mm)	102"(2591mm)	SY ■■■ -42A2-L ■■■■		1318.58	1416.33	2310.17	2407.92
	109.8"(2789mm)	108"(2743mm)	SY ■■■ -42A8-L ■■■■		1351.22	1454.31	2397.31	2500.40
	115.8"(2941mm)	114"(2896mm)	SY ■■■ -42B4-L ■■■■		1383.86	1492.29	2484.45	2592.88
50"(1270mm)								
	19.8"(503mm)	18"(457mm)	SY ■■■ -5018-L ■■■■		\$ 671.19	\$ 704.34	\$ 899.78	\$ 932.93
	25.8"(655mm)	24"(610mm)	SY ■■■ -5024-L ■■■■		703.83	742.32	986.92	1025.41
	31.8"(808mm)	30"(762mm)	SY ■■■ -5030-L ■■■■		736.47	780.30	1074.06	1117.89
	37.8"(960mm)	36"(914mm)	SY ■■■ -5036-L ■■■■		924.55	973.72	1316.64	1365.81
	43.8"(1113mm)	42"(1067mm)	SY ■■■ -5042-L ■■■■		1054.34	1108.85	1500.93	1555.44
	49.8"(1265mm)	48"(1219mm)	SY ■■■ -5048-L ■■■■		1086.98	1146.83	1588.07	1647.92
	45.8"(1163mm)	54"(1372mm)	SY ■■■ -5054-L ■■■■		1119.62	1184.81	1675.21	1740.40
	61.8"(1570mm)	60"(1524mm)	SY ■■■ -5060-L ■■■■		1152.26	1222.79	1762.35	1832.88
	67.8"(1722mm)	66"(1676mm)	SY ■■■ -5066-L ■■■■		1184.90	1260.77	1849.49	1925.36
	73.8"(1875mm)	72"(1829mm)	SY ■■■ -5072-L ■■■■		1217.54	1298.75	1936.63	2017.84
	79.8"(2027mm)	78"(1981mm)	SY ■■■ -5078-L ■■■■		1250.18	1336.73	2023.77	2110.32
	85.8"(2179mm)	84"(2134mm)	SY ■■■ -5084-L ■■■■		1282.82	1374.71	2110.91	2202.80
	91.8"(2332mm)	90"(2286mm)	SY ■■■ -5090-L ■■■■		1315.46	1412.69	2198.05	2295.28
	97.8"(2484mm)	96"(2438mm)	SY ■■■ -5096-L ■■■■		1348.10	1450.67	2285.19	2387.76
	103.8"(2637mm)	102"(2591mm)	SY ■■■ -50A2-L ■■■■		1380.74	1488.65	2372.33	2480.24
	109.8"(2789mm)	108"(2743mm)	SY ■■■ -50A8-L ■■■■		1413.38	1526.63	2459.47	2572.72
	115.8"(2941mm)	114"(2896mm)	SY ■■■ -50B4-L ■■■■		1446.02	1564.61	2546.61	2665.20
Gallery Panels 58"(1473mm)H								
58"(1473mm)	19.8"(503mm)	18"(457mm)	SY ■■■ -5818-L ■■■■		\$ 733.35	\$ 776.66	\$ 961.94	\$ 1005.25
	25.8"(655mm)	24"(610mm)	SY ■■■ -5824-L ■■■■		765.99	814.64	1049.08	1097.73
	31.8"(808mm)	30"(762mm)	SY ■■■ -5830-L ■■■■		798.63	852.62	1136.22	1190.21
	37.8"(960mm)	36"(914mm)	SY ■■■ -5836-L ■■■■		986.71	1046.04	1378.80	1438.13
	43.8"(1113mm)	42"(1067mm)	SY ■■■ -5842-L ■■■■		1116.50	1181.17	1563.09	1627.76
	49.8"(1265mm)	48"(1219mm)	SY ■■■ -5848-L ■■■■		1149.14	1219.15	1650.23	1720.24
	45.8"(1163mm)	54"(1372mm)	SY ■■■ -5854-L ■■■■		1181.78	1257.13	1737.37	1812.72
	61.8"(1570mm)	60"(1524mm)	SY ■■■ -5860-L ■■■■		1214.42	1295.11	1824.51	1905.20

Gallery Panel to Gallery Panel Face Attachment C (Center Mount)

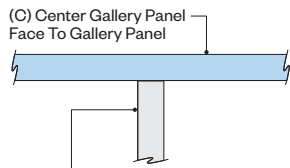
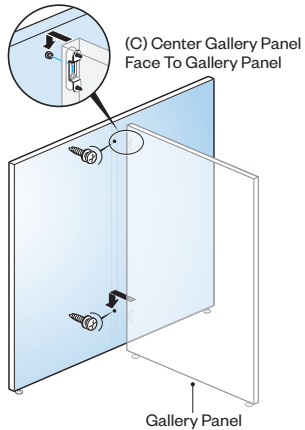

SYCD

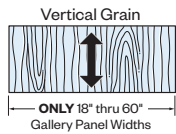
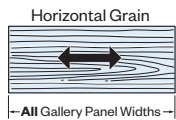

Class BC

Features

- Includes one pre-drilled, finished panel and attachment hardware.
- Gallery Panel is 1.18"(30mm) thick. Additional Gallery Panel adds 1.18"(30mm) to width.
- High Pressure Laminate (HPL) panel has 1mm edgeband.
- Glides provide 1.5"(38mm) level adjustment.
- Panel and hardware are field installed.
- Rail for glass ready option standard in black.
- Handedness is determined by Face Connection.

Specification Tips

- Designed to connect to other Compose Gallery Panels on the Face and/or Ends.
- Connecting Compose Gallery Panels may be shorter, the same height or taller than each other. For each connection:
 - If Gallery Panels are different heights, select the connection height of the shortest Gallery Panel.
 - If Gallery Panels are the same height, select this connection height.
 - Refer to the Specification Guide for Face and End mounting application guidelines.
- Gallery Panel has one face connection only.
- Must separately specify four (two each side) Attachment Brackets (ZUBW-0000-_N) to secure the two Gallery Panels in 90° condition.
- Specify No Glass option when using Glass Topper Holder Kit.
- "No Glass" Gallery Panels option cannot be retrofit to Glass Ready Option.
- Separately specify:
 - Insert Glass for Glass-Ready Gallery Panels
 - Glass Topper Holder Kit

To Order, Specify:

1) Product number, including:

1 Face Connection Height

- A** 26"(660mm)H or 27"(686mm)H Connection
- B** 34"(864mm)H Connection
- C** 42"(1067mm)H Connection
- D** 50"(1270mm)H Connection
- E** 58"(1473mm)H Connection

2 Left End (Finished End or Connection End)

- N** No Connection (Finished End)
- A** 26"(660mm)H or 27"(686mm)H Connection
- B** 34"(864mm)H Connection
- C** 42"(1067mm)H Connection
- D** 50"(1270mm)H Connection
- E** 58"(1473mm)H Connection

3 Right End (Finished End or Connection End)

- N** No Connection (Finished End)
- A** 26"(660mm)H or 27"(686mm)H Connection
- B** 34"(864mm)H Connection
- C** 42"(1067mm)H Connection
- D** 50"(1270mm)H Connection
- E** 58"(1473mm)H Connection

4 Glass Options

- N** No Glass (Finished Top)
- G** Glass Ready

2) Laminate surface color.

3) Edgeband color.

Gallery Panel to Gallery Panel Face Attachment C (Center Mount)

Nominal Height	Actual Width	Nominal Width	Number		No Glass HPL		Glass Ready HPL	
			①	②③④	A	B	A	B
Gallery Panels 26"(660mm)H-34"(864mm)H								
26"(660mm)	19.8"(503mm)	18"(457mm)	SYCA-2618-L	■ ■ ■ ■	\$ 484.71	\$ 487.38	\$ 713.30	\$ 715.97
	25.8"(655mm)	24"(610mm)	SYCA-2624-L	■ ■ ■ ■	517.35	525.36	800.44	808.45
	31.8"(808mm)	30"(762mm)	SYCA-2630-L	■ ■ ■ ■	549.99	563.34	887.58	900.93
	37.8"(960mm)	36"(914mm)	SYCA-2636-L	■ ■ ■ ■	738.07	756.76	1130.16	1148.85
	43.8"(1113mm)	42"(1067mm)	SYCA-2642-L	■ ■ ■ ■	867.86	891.89	1314.45	1338.48
	49.8"(1265mm)	48"(1219mm)	SYCA-2648-L	■ ■ ■ ■	900.50	929.87	1401.59	1430.96
	55.8"(1417mm)	54"(1372mm)	SYCA-2654-L	■ ■ ■ ■	933.14	967.85	1488.73	1523.44
	61.8"(1570mm)	60"(1524mm)	SYCA-2660-L	■ ■ ■ ■	965.78	1005.83	1575.87	1615.92
	67.8"(1722mm)	66"(1676mm)	SYCA-2666-L	■ ■ ■ ■	998.42	1043.81	1663.01	1708.40
	73.8"(1875mm)	72"(1829mm)	SYCA-2672-L	■ ■ ■ ■	1031.06	1081.79	1750.15	1800.88
	79.8"(2027mm)	78"(1981mm)	SYCA-2678-L	■ ■ ■ ■	1063.70	1119.77	1837.29	1893.36
	85.8"(2179mm)	84"(2134mm)	SYCA-2684-L	■ ■ ■ ■	1096.34	1157.75	1924.43	1985.84
	91.8"(2332mm)	90"(2286mm)	SYCA-2690-L	■ ■ ■ ■	1128.98	1195.73	2011.57	2078.32
	97.8"(2484mm)	96"(2438mm)	SYCA-2696-L	■ ■ ■ ■	1161.62	1233.71	2098.71	2170.80
	103.8"(2637mm)	102"(2591mm)	SYCA-26A2-L	■ ■ ■ ■	1194.26	1271.69	2185.85	2263.28
	109.8"(2789mm)	108"(2743mm)	SYCA-26A8-L	■ ■ ■ ■	1226.90	1309.67	2272.99	2355.76
	115.8"(2941mm)	114"(2896mm)	SYCA-26B4-L	■ ■ ■ ■	1259.54	1347.65	2360.13	2448.24
27"(686mm)	19.8"(503mm)	18"(457mm)	SYCA-2718-L	■ ■ ■ ■	\$ 492.48	\$ 496.42	\$ 721.07	\$ 725.01
	25.8"(655mm)	24"(610mm)	SYCA-2724-L	■ ■ ■ ■	525.12	534.40	808.21	817.49
	31.8"(808mm)	30"(762mm)	SYCA-2730-L	■ ■ ■ ■	557.76	572.38	895.35	909.97
	37.8"(960mm)	36"(914mm)	SYCA-2736-L	■ ■ ■ ■	745.84	765.80	1137.93	1157.89
	43.8"(1113mm)	42"(1067mm)	SYCA-2742-L	■ ■ ■ ■	875.63	900.93	1322.22	1347.52
	49.8"(1265mm)	48"(1219mm)	SYCA-2748-L	■ ■ ■ ■	908.27	938.91	1409.36	1440.00
	55.8"(1417mm)	54"(1372mm)	SYCA-2754-L	■ ■ ■ ■	940.91	976.89	1496.50	1532.48
	61.8"(1570mm)	60"(1524mm)	SYCA-2760-L	■ ■ ■ ■	973.55	1014.87	1583.64	1624.96
	67.8"(1722mm)	66"(1676mm)	SYCA-2766-L	■ ■ ■ ■	1006.19	1052.85	1670.78	1717.44
	73.8"(1875mm)	72"(1829mm)	SYCA-2772-L	■ ■ ■ ■	1038.83	1090.83	1757.92	1809.92
	79.8"(2027mm)	78"(1981mm)	SYCA-2778-L	■ ■ ■ ■	1071.47	1128.81	1845.06	1902.40
	85.8"(2179mm)	84"(2134mm)	SYCA-2784-L	■ ■ ■ ■	1104.11	1166.79	1932.20	1994.88
	91.8"(2332mm)	90"(2286mm)	SYCA-2790-L	■ ■ ■ ■	1136.75	1204.77	2019.34	2087.36
	97.8"(2484mm)	96"(2438mm)	SYCA-2796-L	■ ■ ■ ■	1169.39	1242.75	2106.48	2179.84
	103.8"(2637mm)	102"(2591mm)	SYCA-27A2-L	■ ■ ■ ■	1202.03	1280.73	2193.62	2272.32
	109.8"(2789mm)	108"(2743mm)	SYCA-27A8-L	■ ■ ■ ■	1234.67	1318.71	2280.76	2364.80
	115.8"(2941mm)	114"(2896mm)	SYCA-27B4-L	■ ■ ■ ■	1267.31	1356.69	2367.90	2457.28
34"(864mm)	19.8"(503mm)	18"(457mm)	SYC -3418-L	■ ■ ■ ■	\$ 546.87	\$ 559.70	\$ 775.46	\$ 788.29
	25.8"(655mm)	24"(610mm)	SYC -3424-L	■ ■ ■ ■	579.51	597.68	862.60	880.77
	31.8"(808mm)	30"(762mm)	SYC -3430-L	■ ■ ■ ■	612.15	635.66	949.74	973.25
	37.8"(960mm)	36"(914mm)	SYC -3436-L	■ ■ ■ ■	800.23	829.08	1192.32	1221.17
	43.8"(1113mm)	42"(1067mm)	SYC -3442-L	■ ■ ■ ■	930.02	964.21	1376.61	1410.80
	49.8"(1265mm)	48"(1219mm)	SYC -3448-L	■ ■ ■ ■	962.66	1002.19	1463.75	1503.28
	55.8"(1417mm)	54"(1372mm)	SYC -3454-L	■ ■ ■ ■	995.30	1040.17	1550.89	1595.76
	61.8"(1570mm)	60"(1524mm)	SYC -3460-L	■ ■ ■ ■	1027.94	1078.15	1638.03	1688.24
	67.8"(1722mm)	66"(1676mm)	SYC -3466-L	■ ■ ■ ■	1060.58	1116.13	1725.17	1780.72
	73.8"(1875mm)	72"(1829mm)	SYC -3472-L	■ ■ ■ ■	1093.22	1154.11	1812.31	1873.20
	79.8"(2027mm)	78"(1981mm)	SYC -3478-L	■ ■ ■ ■	1125.86	1192.09	1899.45	1965.68
	85.8"(2179mm)	84"(2134mm)	SYC -3484-L	■ ■ ■ ■	1158.50	1230.07	1986.59	2058.16
	91.8"(2332mm)	90"(2286mm)	SYC -3490-L	■ ■ ■ ■	1191.14	1268.05	2073.73	2150.64
	97.8"(2484mm)	96"(2438mm)	SYC -3496-L	■ ■ ■ ■	1223.78	1306.03	2160.87	2243.12
	103.8"(2637mm)	102"(2591mm)	SYC -34A2-L	■ ■ ■ ■	1256.42	1344.01	2248.01	2335.60
	109.8"(2789mm)	108"(2743mm)	SYC -34A8-L	■ ■ ■ ■	1289.06	1381.99	2335.15	2428.08
	115.8"(2941mm)	114"(2896mm)	SYC -34B4-L	■ ■ ■ ■	1321.70	1419.97	2422.29	2520.56

Gallery Panel to Gallery Panel Face Attachment C (Center Mount)

Nominal Height	Actual Width	Nominal Width	Number		No Glass HPL		Glass Ready HPL	
			①	②③④	A	B	A	B
Gallery Panels 42"(1067mm)H-50"(1270mm)H								
42"(1067mm)	19.8"(503mm)	18"(457mm)	SYC	-4218-L	\$ 609.03	\$ 632.02	\$ 837.62	\$ 860.61
	25.8"(655mm)	24"(610mm)	SYC	-4224-L	641.67	670.00	924.76	953.09
	31.8"(808mm)	30"(762mm)	SYC	-4230-L	674.31	707.98	1011.90	1045.57
	37.8"(960mm)	36"(914mm)	SYC	-4236-L	862.39	901.40	1254.48	1293.49
	43.8"(1113mm)	42"(1067mm)	SYC	-4242-L	992.18	1036.53	1438.77	1483.12
	49.8"(1265mm)	48"(1219mm)	SYC	-4248-L	1024.82	1074.51	1525.91	1575.60
	55.8"(1417mm)	54"(1372mm)	SYC	-4254-L	1057.46	1112.49	1613.05	1668.08
	61.8"(1570mm)	60"(1524mm)	SYC	-4260-L	1090.10	1150.47	1700.19	1760.56
	67.8"(1722mm)	66"(1676mm)	SYC	-4266-L	1122.74	1188.45	1787.33	1853.04
	73.8"(1875mm)	72"(1829mm)	SYC	-4272-L	1155.38	1226.43	1874.47	1945.52
	79.8"(2027mm)	78"(1981mm)	SYC	-4278-L	1188.02	1264.41	1961.61	2038.00
	85.8"(2179mm)	84"(2134mm)	SYC	-4284-L	1220.66	1302.39	2048.75	2130.48
	91.8"(2332mm)	90"(2286mm)	SYC	-4290-L	1253.30	1340.37	2135.89	2222.96
	97.8"(2484mm)	96"(2438mm)	SYC	-4296-L	1285.94	1378.35	2223.03	2315.44
	103.8"(2637mm)	102"(2591mm)	SYC	-42A2-L	1318.58	1416.33	2310.17	2407.92
	109.8"(2789mm)	108"(2743mm)	SYC	-42A8-L	1351.22	1454.31	2397.31	2500.40
	115.8"(2941mm)	114"(2896mm)	SYC	-42B4-L	1383.86	1492.29	2484.45	2592.88
50"(1270mm)								
	19.8"(503mm)	18"(457mm)	SYC	-5018-L	\$ 671.19	\$ 704.34	\$ 899.78	\$ 932.93
	25.8"(655mm)	24"(610mm)	SYC	-5024-L	703.83	742.32	986.92	1025.41
	31.8"(808mm)	30"(762mm)	SYC	-5030-L	736.47	780.30	1074.06	1117.89
	37.8"(960mm)	36"(914mm)	SYC	-5036-L	924.55	973.72	1316.64	1365.81
	43.8"(1113mm)	42"(1067mm)	SYC	-5042-L	1054.34	1108.85	1500.93	1555.44
	49.8"(1265mm)	48"(1219mm)	SYC	-5048-L	1086.98	1146.83	1588.07	1647.92
	55.8"(1417mm)	54"(1372mm)	SYC	-5054-L	1119.62	1184.81	1675.21	1740.40
	61.8"(1570mm)	60"(1524mm)	SYC	-5060-L	1152.26	1222.79	1762.35	1832.88
	67.8"(1722mm)	66"(1676mm)	SYC	-5066-L	1184.90	1260.77	1849.49	1925.36
	73.8"(1875mm)	72"(1829mm)	SYC	-5072-L	1217.54	1298.75	1936.63	2017.84
	79.8"(2027mm)	78"(1981mm)	SYC	-5078-L	1250.18	1336.73	2023.77	2110.32
	85.8"(2179mm)	84"(2134mm)	SYC	-5084-L	1282.82	1374.71	2110.91	2202.80
	91.8"(2332mm)	90"(2286mm)	SYC	-5090-L	1315.46	1412.69	2198.05	2295.28
	97.8"(2484mm)	96"(2438mm)	SYC	-5096-L	1348.10	1450.67	2285.19	2387.76
	103.8"(2637mm)	102"(2591mm)	SYC	-50A2-L	1380.74	1488.65	2372.33	2480.24
	109.8"(2789mm)	108"(2743mm)	SYC	-50A8-L	1413.38	1526.63	2459.47	2572.72
	115.8"(2941mm)	114"(2896mm)	SYC	-50B4-L	1446.02	1564.61	2546.61	2665.20
Gallery Panels 58"(1473mm)H								
58"(1473mm)	19.8"(503mm)	18"(457mm)	SYC	-5818-L	\$ 733.35	\$ 776.66	\$ 961.94	\$ 1005.25
	25.8"(655mm)	24"(610mm)	SYC	-5824-L	765.99	814.64	1049.08	1097.73
	31.8"(808mm)	30"(762mm)	SYC	-5830-L	798.63	852.62	1136.22	1190.21
	37.8"(960mm)	36"(914mm)	SYC	-5836-L	986.71	1046.04	1378.80	1438.13
	43.8"(1113mm)	42"(1067mm)	SYC	-5842-L	1116.50	1181.17	1563.09	1627.76
	49.8"(1265mm)	48"(1219mm)	SYC	-5848-L	1149.14	1219.15	1650.23	1720.24
	55.8"(1417mm)	54"(1372mm)	SYC	-5854-L	1181.78	1257.13	1737.37	1812.72
	61.8"(1570mm)	60"(1524mm)	SYC	-5860-L	1214.42	1295.11	1824.51	1905.20

Gallery Panel to Gallery Panel End Attachment I (90° Face or Post Connection)

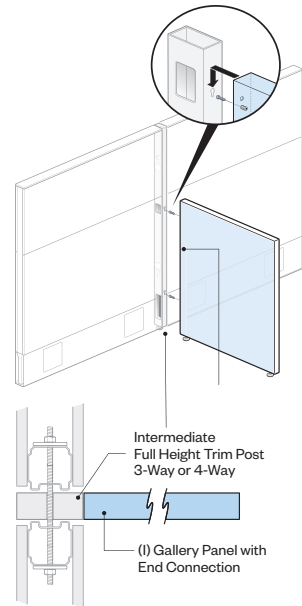
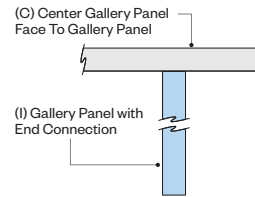
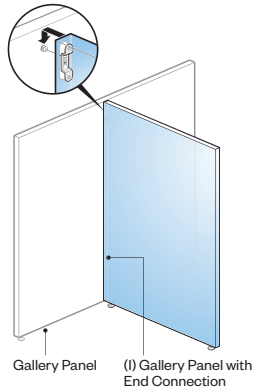

SYSN

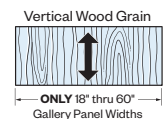
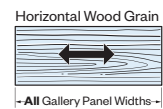

Class BC

Features

- Includes one pre-drilled, finished panel and attachment hardware.
- Panel is 1.18"(30mm) thick.
- High Pressure Laminate (HPL) panel has 1mm edgeband.
- Glides provide 1.5"(38mm) level adjustment.
- Panel and hardware are field installed.
- Rail for glass ready option standard in black.

Specification Tips

- Connection End is designed to attach to other Compose Gallery Panels perpendicular to the Face (L/R or C) or Connection End to Intermediate Full Height Trim Post -3-Way or 4-Way.
- Connecting Gallery Panels may be shorter, the same height or taller than each other. For each connection:
 - If Gallery Panels are different heights, select the connection height of the shortest Gallery Panel.
 - If Gallery Panels are the same height, select this connection height.
 - Refer to the Specification Guide for Face and End mounting application guidelines.
- Gallery Panel has End connections only.
- Must separately specify two (one each side) Tie Plates (ZBBP-0000-PN) to secure End-to-End Gallery Panels in 180° conditions. Required at each End-to-End connection. Tie Plates are not required for Post Connection Option.
- Specify No Glass option when using Glass Topper Holder Kit.
- "No Glass" Gallery Panels option cannot be retrofitted to Glass Ready Option.
- Separately specify:
 - Insert Glass for Glass-Ready Gallery Panels
 - Glass Topper Holder Kit

To Order, Specify:

1) Product number, including:

1 Connection End

- A** 26"(660mm)H or 27"(686mm)H Connection
- B** 34"(864mm)H Connection
- C** 42"(1067mm)H Connection
- D** 50"(1270mm)H Connection
- E** 58"(1473mm)H Connection
- Z** Post Connection

2 Other End (Finished End or Connection End)

- N** No Connection (Finished End)
- A** 26"(660mm)H or 27"(686mm)H Connection
- B** 34"(864mm)H Connection
- C** 42"(1067mm)H Connection
- D** 50"(1270mm)H Connection
- E** 58"(1473mm)H Connection

3 Glass Options

- N** No Glass (Finished Top)
- G** Glass Ready

2) Laminate surface color.

3) Edgeband color.

Gallery Panel to Gallery Panel End Attachment I (90° Face or Post Connection)

Nominal Height	Nominal Width	Number ①②③	No Glass HPL		Glass Ready HPL	
			A	B	A	B
Gallery Panels 26"(660mm)H-34"(864mm)H						
26"(660mm)	18"(457mm)	SYIN-2618-LA	\$ 508.20	\$ 510.87	\$ 736.79	\$ 739.46
	24"(610mm)	SYIN-2624-LA	540.84	548.85	823.93	831.94
	30"(762mm)	SYIN-2630-LA	573.48	586.83	911.07	924.42
	36"(914mm)	SYIN-2636-LA	761.56	780.25	1153.65	1172.34
	42"(1067mm)	SYIN-2642-LA	891.35	915.38	1337.94	1361.97
	48"(1219mm)	SYIN-2648-LA	923.99	953.36	1425.08	1454.45
	54"(1372mm)	SYIN-2654-LA	956.63	991.34	1512.22	1546.93
	60"(1524mm)	SYIN-2660-LA	989.27	1029.32	1599.36	1639.41
	66"(1676mm)	SYIN-2666-LA	1021.91	1067.30	1686.50	1731.89
	72"(1829mm)	SYIN-2672-LA	1054.55	1105.28	1773.64	1824.37
	78"(1981mm)	SYIN-2678-LA	1087.19	1143.26	1860.78	1916.85
	84"(2134mm)	SYIN-2684-LA	1119.83	1181.24	1947.92	2009.33
	90"(2286mm)	SYIN-2690-LA	1152.47	1219.22	2035.06	2101.81
	96"(2438mm)	SYIN-2696-LA	1185.11	1257.20	2122.20	2194.29
	102"(2591mm)	SYIN-26A2-LA	1217.75	1295.18	2209.34	2286.77
	108"(2743mm)	SYIN-26A8-LA	1250.39	1333.16	2296.48	2379.25
114"(2896mm)	SYIN-26B4-LA	1283.03	1371.14	2383.62	2471.73	
120"(3048mm)	SYIN-26C0-LA	1315.67	1409.12	2470.76	2564.21	
27"(686mm)	18"(457mm)	SYIN-2718-LA	\$ 515.97	\$ 519.91	\$ 744.56	\$ 748.50
	24"(610mm)	SYIN-2724-LA	548.61	557.89	831.70	840.98
	30"(762mm)	SYIN-2730-LA	581.25	595.87	918.84	933.46
	36"(914mm)	SYIN-2736-LA	769.33	789.29	1161.42	1181.38
	42"(1067mm)	SYIN-2742-LA	899.12	924.42	1345.71	1371.01
	48"(1219mm)	SYIN-2748-LA	931.76	962.40	1432.85	1463.49
	54"(1372mm)	SYIN-2754-LA	964.40	1000.38	1519.99	1555.97
	60"(1524mm)	SYIN-2760-LA	997.04	1038.36	1607.13	1648.45
	66"(1676mm)	SYIN-2766-LA	1029.68	1076.34	1694.27	1740.93
	72"(1829mm)	SYIN-2772-LA	1062.32	1114.32	1781.41	1833.41
	78"(1981mm)	SYIN-2778-LA	1094.96	1152.30	1868.55	1925.89
	84"(2134mm)	SYIN-2784-LA	1127.60	1190.28	1955.69	2018.37
	90"(2286mm)	SYIN-2790-LA	1160.24	1228.26	2042.83	2110.85
	96"(2438mm)	SYIN-2796-LA	1192.88	1266.24	2129.97	2203.33
	102"(2591mm)	SYIN-27A2-LA	1225.52	1304.22	2217.11	2295.81
	108"(2743mm)	SYIN-27A8-LA	1258.16	1342.20	2304.25	2388.29
114"(2896mm)	SYIN-27B4-LA	1290.80	1380.18	2391.39	2480.77	
120"(3048mm)	SYIN-27C0-LA	1323.44	1418.16	2478.53	2573.25	
34"(864mm)	18"(457mm)	SYIN-3418-L	\$ 570.36	\$ 583.19	\$ 798.95	\$ 811.78
	24"(610mm)	SYIN-3424-L	603.00	621.17	886.09	904.26
	30"(762mm)	SYIN-3430-L	635.64	659.15	973.23	996.74
	36"(914mm)	SYIN-3436-L	823.72	852.57	1215.81	1244.66
	42"(1067mm)	SYIN-3442-L	953.51	987.70	1400.10	1434.29
	48"(1219mm)	SYIN-3448-L	986.15	1025.68	1487.24	1526.77
	54"(1372mm)	SYIN-3454-L	1018.79	1063.66	1574.38	1619.25
	60"(1524mm)	SYIN-3460-L	1051.43	1101.64	1661.52	1711.73
	66"(1676mm)	SYIN-3466-L	1084.07	1139.62	1748.66	1804.21
	72"(1829mm)	SYIN-3472-L	1116.71	1177.60	1835.80	1896.69
	78"(1981mm)	SYIN-3478-L	1149.35	1215.58	1922.94	1989.17
	84"(2134mm)	SYIN-3484-L	1181.99	1253.56	2010.08	2081.65
	90"(2286mm)	SYIN-3490-L	1214.63	1291.54	2097.22	2174.13
	96"(2438mm)	SYIN-3496-L	1247.27	1329.52	2184.36	2266.61
	102"(2591mm)	SYIN-34A2-L	1279.91	1367.50	2271.50	2359.09
	108"(2743mm)	SYIN-34A8-L	1312.55	1405.48	2358.64	2451.57
114"(2896mm)	SYIN-34B4-L	1345.19	1443.46	2445.78	2544.05	
120"(3048mm)	SYIN-34C0-L	1377.83	1481.44	2532.92	2636.53	

Gallery Panel to Gallery Panel End Attachment I (90° Face or Post Connection)

Nominal Height	Nominal Width	Number ①②③	No Glass HPL		Glass Ready HPL	
			A	B	A	B
Gallery Panels 42"(1067mm)H-50"(1270mm)H						
42"(1067mm)	18"(457mm)	SYIN-4218-L	\$ 632.52	\$ 655.51	\$ 861.11	\$ 884.10
	24"(610mm)	SYIN-4224-L	665.16	693.49	948.25	976.58
	30"(762mm)	SYIN-4230-L	697.80	731.47	1035.39	1069.06
	36"(914mm)	SYIN-4236-L	885.88	924.89	1277.97	1316.98
	42"(1067mm)	SYIN-4242-L	1015.67	1060.02	1462.26	1506.61
	48"(1219mm)	SYIN-4248-L	1048.31	1098.00	1549.40	1599.09
	54"(1372mm)	SYIN-4254-L	1080.95	1135.98	1636.54	1691.57
	60"(1524mm)	SYIN-4260-L	1113.59	1173.96	1723.68	1784.05
	66"(1676mm)	SYIN-4266-L	1146.23	1211.94	1810.82	1876.53
	72"(1829mm)	SYIN-4272-L	1178.87	1249.92	1897.96	1969.01
	78"(1981mm)	SYIN-4278-L	1211.51	1287.90	1985.10	2061.49
	84"(2134mm)	SYIN-4284-L	1244.15	1325.88	2072.24	2153.97
	90"(2286mm)	SYIN-4290-L	1276.79	1363.86	2159.38	2246.45
	96"(2438mm)	SYIN-4296-L	1309.43	1401.84	2246.52	2338.93
	102"(2591mm)	SYIN-42A2-L	1342.07	1439.82	2333.66	2431.41
	108"(2743mm)	SYIN-42A8-L	1374.71	1477.80	2420.80	2523.89
114"(2896mm)	SYIN-42B4-L	1407.35	1515.78	2507.94	2616.37	
120"(3048mm)	SYIN-42C0-L	1439.99	1553.76	2595.08	2708.85	
50"(1270mm)	18"(457mm)	SYIN-5018-L	\$ 694.68	\$ 727.83	\$ 923.27	\$ 956.42
	24"(610mm)	SYIN-5024-L	727.32	765.81	1010.41	1048.90
	30"(762mm)	SYIN-5030-L	759.96	803.79	1097.55	1141.38
	36"(914mm)	SYIN-5036-L	948.04	997.21	1340.13	1389.30
	42"(1067mm)	SYIN-5042-L	1077.83	1132.34	1524.42	1578.93
	48"(1219mm)	SYIN-5048-L	1110.47	1170.32	1611.56	1671.41
	54"(1372mm)	SYIN-5054-L	1143.11	1208.30	1698.70	1763.89
	60"(1524mm)	SYIN-5060-L	1175.75	1246.28	1785.84	1856.37
	66"(1676mm)	SYIN-5066-L	1208.39	1284.26	1872.98	1948.85
	72"(1829mm)	SYIN-5072-L	1241.03	1322.24	1960.12	2041.33
	78"(1981mm)	SYIN-5078-L	1273.67	1360.22	2047.26	2133.81
	84"(2134mm)	SYIN-5084-L	1306.31	1398.20	2134.40	2226.29
	90"(2286mm)	SYIN-5090-L	1338.95	1436.18	2221.54	2318.77
	96"(2438mm)	SYIN-5096-L	1371.59	1474.16	2308.68	2411.25
	102"(2591mm)	SYIN-50A2-L	1404.23	1512.14	2395.82	2503.73
	108"(2743mm)	SYIN-50A8-L	1436.87	1550.12	2482.96	2596.21
114"(2896mm)	SYIN-50B4-L	1469.51	1588.10	2570.10	2688.69	
120"(3048mm)	SYIN-50C0-L	1502.15	1626.08	2657.24	2781.17	
Gallery Panels 58"(1473mm)H						
58"(1473mm)	18"(457mm)	SYIN-5818-L	\$ 756.84	\$ 800.15	\$ 985.43	\$ 1028.74
	24"(610mm)	SYIN-5824-L	789.48	838.13	1072.57	1121.22
	30"(762mm)	SYIN-5830-L	822.12	876.11	1159.71	1213.70
	36"(914mm)	SYIN-5836-L	1010.20	1069.53	1402.29	1461.62
	42"(1067mm)	SYIN-5842-L	1139.99	1204.66	1586.58	1651.25
	48"(1219mm)	SYIN-5848-L	1172.63	1242.64	1673.72	1743.73
	54"(1372mm)	SYIN-5854-L	1205.27	1280.62	1760.86	1836.21
	60"(1524mm)	SYIN-5860-L	1237.91	1318.60	1848.00	1928.69
	66"(1676mm)	SYIN-5866-L	1270.55	1356.58	1935.14	2021.17
	72"(1829mm)	SYIN-5872-L	1303.19	1394.56	2022.28	2113.65
	78"(1981mm)	SYIN-5878-L	1335.83	1432.54	2109.42	2206.13
	84"(2134mm)	SYIN-5884-L	1368.47	1470.52	2196.56	2298.61
	90"(2286mm)	SYIN-5890-L	1401.11	1508.50	2283.70	2391.09
	96"(2438mm)	SYIN-5896-L	1433.75	1546.48	2370.84	2483.57
	102"(2591mm)	SYIN-58A2-L	1466.39	1584.46	2457.98	2576.05
	108"(2743mm)	SYIN-58A8-L	1499.03	1622.44	2545.12	2668.53
114"(2896mm)	SYIN-58B4-L	1531.67	1660.42	2632.26	2761.01	
120"(3048mm)	SYIN-58C0-L	1564.31	1698.40	2719.40	2853.49	

Gallery Panel to Gallery Panel End Attachment

S (Straight In-Line Add-On)

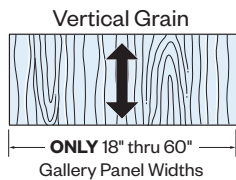
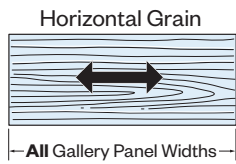
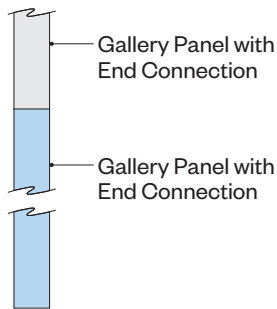
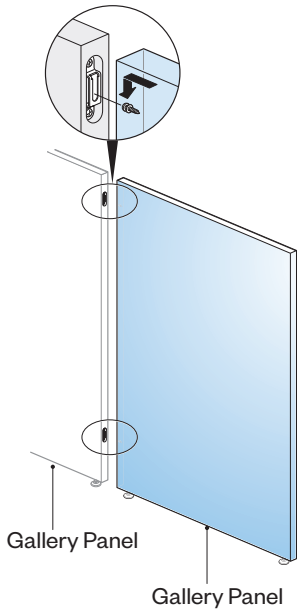

SYSN
Class BC

Features

- Includes one pre-drilled, finished panel and attachment hardware.
- Panel is 1.18"(30mm) thick.
- High Pressure Laminate (HPL) panel has 1mm edgeband.
- Glides provide 1.5"(38mm) level adjustment.
- Panel and hardware are field installed.
- Rail for glass ready option standard in black.

Specification Tips

- Connection End is designed to attach to another Compose Gallery Panel End-to-End in straight in-line conditions.
- Connecting Gallery Panels may be shorter, the same height or taller than each other. For each connection:
 - If Gallery Panels are different heights, select the connection height of the shortest Gallery Panel.
 - If Gallery Panels are the same height, select this connection height.
 - Refer to the Specification Guide for Face and End mounting application guidelines.
- Gallery Panel has End connections only.
- Must separately specify two (one each side) Tie Plates (ZBBP-0000-PN) to secure End-to-End Gallery Panels in 180° conditions. Required at each End-to-End connection.
- Specify No Glass option when using Glass Topper Holder Kit.
- "No Glass" Gallery Panels option cannot be retrofitted to Glass Ready Option.
- Separately specify:
 - Insert Glass for Glass-Ready Gallery Panels
 - Glass Topper Holder Kit

To Order, Specify:

1) Product number, including:

1 Connection End

- A** 26"(660mm)H or 27"(686mm)H Connection
- B** 34"(864mm)H Connection
- C** 42"(1067mm)H Connection
- D** 50"(1270mm)H Connection
- E** 58"(1473mm)H Connection

2 Other End (Finished End or Connection End)

- N** No Connection (Finished End)
- A** 26"(660mm)H or 27"(686mm)H Connection
- B** 34"(864mm)H Connection
- C** 42"(1067mm)H Connection
- D** 50"(1270mm)H Connection
- E** 58"(1473mm)H Connection

3 Glass Options

- N** No Glass (Finished Top)
- G** Glass Ready

2) Laminate surface color.
3) Edgeband color.

Gallery Panel to Gallery Panel End Attachment

S (Straight In-Line Add-On)

Nominal Height	Nominal Width	Number ①②③	No Glass		Glass Ready	
			HPL A	HPL B	HPL A	HPL B
Gallery Panels 26"(660mm)H-34"(864mm)H						
26"(660mm)	18"(457mm)	SYSN-2618-LA	\$ 508.20	\$ 510.87	\$ 736.79	\$ 739.46
	24"(610mm)	SYSN-2624-LA	540.84	548.85	823.93	831.94
	30"(762mm)	SYSN-2630-LA	573.48	586.83	911.07	924.42
	36"(914mm)	SYSN-2636-LA	761.56	780.25	1153.65	1172.34
	42"(1067mm)	SYSN-2642-LA	891.35	915.38	1337.94	1361.97
	48"(1219mm)	SYSN-2648-LA	923.99	953.36	1425.08	1454.45
	54"(1372mm)	SYSN-2654-LA	956.63	991.34	1512.22	1546.93
	60"(1524mm)	SYSN-2660-LA	989.27	1029.32	1599.36	1639.41
	66"(1676mm)	SYSN-2666-LA	1021.91	1067.30	1686.50	1731.89
	72"(1829mm)	SYSN-2672-LA	1054.55	1105.28	1773.64	1824.37
	78"(1981mm)	SYSN-2678-LA	1087.19	1143.26	1860.78	1916.85
	84"(2134mm)	SYSN-2684-LA	1119.83	1181.24	1947.92	2009.33
	90"(2286mm)	SYSN-2690-LA	1152.47	1219.22	2035.06	2101.81
	96"(2438mm)	SYSN-2696-LA	1185.11	1257.20	2122.20	2194.29
	102"(2591mm)	SYSN-26A2-LA	1217.75	1295.18	2209.34	2286.77
108"(2743mm)	SYSN-26A8-LA	1250.39	1333.16	2296.48	2379.25	
114"(2896mm)	SYSN-26B4-LA	1283.03	1371.14	2383.62	2471.73	
120"(3048mm)	SYSN-26C0-LA	1315.67	1409.12	2470.76	2564.21	
27"(686mm)	18"(457mm)	SYSN-2718-LA	\$ 515.97	\$ 519.91	\$ 744.56	\$ 748.50
	24"(610mm)	SYSN-2724-LA	548.61	557.89	831.70	840.98
	30"(762mm)	SYSN-2730-LA	581.25	595.87	918.84	933.46
	36"(914mm)	SYSN-2736-LA	769.33	789.29	1161.42	1181.38
	42"(1067mm)	SYSN-2742-LA	899.12	924.42	1345.71	1371.01
	48"(1219mm)	SYSN-2748-LA	931.76	962.40	1432.85	1463.49
	54"(1372mm)	SYSN-2754-LA	964.40	1000.38	1519.99	1555.97
	60"(1524mm)	SYSN-2760-LA	997.04	1038.36	1607.13	1648.45
	66"(1676mm)	SYSN-2766-LA	1029.68	1076.34	1694.27	1740.93
	72"(1829mm)	SYSN-2772-LA	1062.32	1114.32	1781.41	1833.41
	78"(1981mm)	SYSN-2778-LA	1094.96	1152.30	1868.55	1925.89
	84"(2134mm)	SYSN-2784-LA	1127.60	1190.28	1955.69	2018.37
	90"(2286mm)	SYSN-2790-LA	1160.24	1228.26	2042.83	2110.85
	96"(2438mm)	SYSN-2796-LA	1192.88	1266.24	2129.97	2203.33
	102"(2591mm)	SYSN-27A2-LA	1225.52	1304.22	2217.11	2295.81
108"(2743mm)	SYSN-27A8-LA	1258.16	1342.20	2304.25	2388.29	
114"(2896mm)	SYSN-27B4-LA	1290.80	1380.18	2391.39	2480.77	
120"(3048mm)	SYSN-27C0-LA	1323.44	1418.16	2478.53	2573.25	
34"(864mm)	18"(457mm)	SYSN-3418-L	\$ 570.36	\$ 583.19	\$ 798.95	\$ 811.78
	24"(610mm)	SYSN-3424-L	603.00	621.17	886.09	904.26
	30"(762mm)	SYSN-3430-L	635.64	659.15	973.23	996.74
	36"(914mm)	SYSN-3436-L	823.72	852.57	1215.81	1244.66
	42"(1067mm)	SYSN-3442-L	953.51	987.70	1400.10	1434.29
	48"(1219mm)	SYSN-3448-L	986.15	1025.68	1487.24	1526.77
	54"(1372mm)	SYSN-3454-L	1018.79	1063.66	1574.38	1619.25
	60"(1524mm)	SYSN-3460-L	1051.43	1101.64	1661.52	1711.73
	66"(1676mm)	SYSN-3466-L	1084.07	1139.62	1748.66	1804.21
	72"(1829mm)	SYSN-3472-L	1116.71	1177.60	1835.80	1896.69
	78"(1981mm)	SYSN-3478-L	1149.35	1215.58	1922.94	1989.17
	84"(2134mm)	SYSN-3484-L	1181.99	1253.56	2010.08	2081.65
	90"(2286mm)	SYSN-3490-L	1214.63	1291.54	2097.22	2174.13
	96"(2438mm)	SYSN-3496-L	1247.27	1329.52	2184.36	2266.61
	102"(2591mm)	SYSN-34A2-L	1279.91	1367.50	2271.50	2359.09
108"(2743mm)	SYSN-34A8-L	1312.55	1405.48	2358.64	2451.57	
114"(2896mm)	SYSN-34B4-L	1345.19	1443.46	2445.78	2544.05	
120"(3048mm)	SYSN-34C0-L	1377.83	1481.44	2532.92	2636.53	

Gallery Panel to Gallery Panel End Attachment S (Straight In-Line Add-On)

Nominal Height	Nominal Width	Number ①②③	No Glass		Glass Ready	
			HPL A	HPL B	HPL A	HPL B
Gallery Panels 42"(1067mm)H-50"(1270mm)H						
42"(1067mm)	18"(457mm)	SYSN-4218-L	\$ 632.52	\$ 655.51	\$ 861.11	\$ 884.10
	24"(610mm)	SYSN-4224-L	665.16	693.49	948.25	976.58
	30"(762mm)	SYSN-4230-L	697.80	731.47	1035.39	1069.06
	36"(914mm)	SYSN-4236-L	885.88	924.89	1277.97	1316.98
	42"(1067mm)	SYSN-4242-L	1015.67	1060.02	1462.26	1506.61
	48"(1219mm)	SYSN-4248-L	1048.31	1098.00	1549.40	1599.09
	54"(1372mm)	SYSN-4254-L	1080.95	1135.98	1636.54	1691.57
	60"(1524mm)	SYSN-4260-L	1113.59	1173.96	1723.68	1784.05
	66"(1676mm)	SYSN-4266-L	1146.23	1211.94	1810.82	1876.53
	72"(1829mm)	SYSN-4272-L	1178.87	1249.92	1897.96	1969.01
	78"(1981mm)	SYSN-4278-L	1211.51	1287.90	1985.10	2061.49
	84"(2134mm)	SYSN-4284-L	1244.15	1325.88	2072.24	2153.97
	90"(2286mm)	SYSN-4290-L	1276.79	1363.86	2159.38	2246.45
	96"(2438mm)	SYSN-4296-L	1309.43	1401.84	2246.52	2338.93
	102"(2591mm)	SYSN-42A2-L	1342.07	1439.82	2333.66	2431.41
	50"(1270mm)	108"(2743mm)	SYSN-42A8-L	1374.71	1477.80	2420.80
114"(2896mm)		SYSN-42B4-L	1407.35	1515.78	2507.94	2616.37
120"(3048mm)		SYSN-42C0-L	1439.99	1553.76	2595.08	2708.85
18"(457mm)		SYSN-5018-L	\$ 694.68	\$ 727.83	\$ 923.27	\$ 956.42
24"(610mm)		SYSN-5024-L	727.32	765.81	1010.41	1048.90
30"(762mm)		SYSN-5030-L	759.96	803.79	1097.55	1141.38
36"(914mm)		SYSN-5036-L	948.04	997.21	1340.13	1389.30
42"(1067mm)		SYSN-5042-L	1077.83	1132.34	1524.42	1578.93
48"(1219mm)		SYSN-5048-L	1110.47	1170.32	1611.56	1671.41
54"(1372mm)		SYSN-5054-L	1143.11	1208.30	1698.70	1763.89
60"(1524mm)		SYSN-5060-L	1175.75	1246.28	1785.84	1856.37
66"(1676mm)		SYSN-5066-L	1208.39	1284.26	1872.98	1948.85
72"(1829mm)		SYSN-5072-L	1241.03	1322.24	1960.12	2041.33
78"(1981mm)		SYSN-5078-L	1273.67	1360.22	2047.26	2133.81
84"(2134mm)		SYSN-5084-L	1306.31	1398.20	2134.40	2226.29
90"(2286mm)		SYSN-5090-L	1338.95	1436.18	2221.54	2318.77
96"(2438mm)	SYSN-5096-L	1371.59	1474.16	2308.68	2411.25	
102"(2591mm)	SYSN-50A2-L	1404.23	1512.14	2395.82	2503.73	
108"(2743mm)	SYSN-50A8-L	1436.87	1550.12	2482.96	2596.21	
114"(2896mm)	SYSN-50B4-L	1469.51	1588.10	2570.10	2688.69	
120"(3048mm)	SYSN-50C0-L	1502.15	1626.08	2657.24	2781.17	
Gallery Panels 58"(1473mm)H						
58"(1473mm)	18"(457mm)	SYSN-5818-L	\$ 756.84	\$ 800.15	\$ 985.43	\$ 1028.74
	24"(610mm)	SYSN-5824-L	789.48	838.13	1072.57	1121.22
	30"(762mm)	SYSN-5830-L	822.12	876.11	1159.71	1213.70
	36"(914mm)	SYSN-5836-L	1010.20	1069.53	1402.29	1461.62
	42"(1067mm)	SYSN-5842-L	1139.99	1204.66	1586.58	1651.25
	48"(1219mm)	SYSN-5848-L	1172.63	1242.64	1673.72	1743.73
	54"(1372mm)	SYSN-5854-L	1205.27	1280.62	1760.86	1836.21
	60"(1524mm)	SYSN-5860-L	1237.91	1318.60	1848.00	1928.69
	66"(1676mm)	SYSN-5866-L	1270.55	1356.58	1935.14	2021.17
	72"(1829mm)	SYSN-5872-L	1303.19	1394.56	2022.28	2113.65
	78"(1981mm)	SYSN-5878-L	1335.83	1432.54	2109.42	2206.13
	84"(2134mm)	SYSN-5884-L	1368.47	1470.52	2196.56	2298.61
	90"(2286mm)	SYSN-5890-L	1401.11	1508.50	2283.70	2391.09
	96"(2438mm)	SYSN-5896-L	1433.75	1546.48	2370.84	2483.57
	102"(2591mm)	SYSN-58A2-L	1466.39	1584.46	2457.98	2576.05
	108"(2743mm)	SYSN-58A8-L	1499.03	1622.44	2545.12	2668.53
114"(2896mm)	SYSN-58B4-L	1531.67	1660.42	2632.26	2761.01	
120"(3048mm)	SYSN-58C0-L	1564.31	1698.40	2719.40	2853.49	

Gallery Panel Accessories

Brackets

Tie Plate

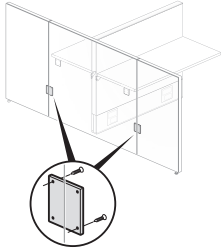

ZBBP-0000-PN
Class IN

Features

- Includes tie plate and attachment hardware.
- Tie plate is used to connect Gallery Panels inline.

Specification Tip

- Refer to Specification Guide for planning information.

To Order, Specify:

- 1) Product number.
- 2) Trim color (if applicable).

Description	Depth	Width	Number	Price	Trim	
					A	B
Black (No finish specification required)	3.5"(89mm)	3"(76mm)	ZBBP-0000-PN	\$28.62	N/A	N/A
Painted			ZBBP-0000-CN		\$34.62	\$39.62

Gallery Panel Accessories

Glass Topper

Nominal Height	Nominal Width	Number ①	Clear Glass (1C)	Satin Etch (E21)
8"(203mm)	18"(457mm)	VZSG-0818-1 4	\$ 376.84	\$ 395.95
	24"(610mm)	VZSG-0824-1 4	410.25	454.17
	30"(762mm)	VZSG-0830-1 4	443.66	512.39
	36"(914mm)	VZSG-0836-1 4	477.07	570.61
	42"(1067mm)	VZSG-0842-1 4	510.48	628.83
	48"(1219mm)	VZSG-0848-1 4	543.89	687.05
	54"(1372mm)	VZSG-0854-1 4	577.30	745.27
	60"(1524mm)	VZSG-0860-1 4	610.71	803.49
	66"(1676mm)	VZSG-0866-1 4	644.12	861.71
	72"(1829mm)	VZSG-0872-1 4	878.16	1120.56
	78"(1981mm)	VZSG-0878-1 4	986.49	1253.70
	84"(2134mm)	VZSG-0884-1 4	1019.90	1311.92
	90"(2286mm)	VZSG-0890-1 4	1053.31	1370.14
	96"(2438mm)	VZSG-0896-1 4	1086.72	1428.36
12"(305mm)	102"(2591mm)	VZSG-08A2-1 4	1120.13	1486.58
	108"(2743mm)	VZSG-08A8-1 4	1153.54	1544.80
	114"(2896mm)	VZSG-08B4-1 4	1186.95	1603.02
	120"(3048mm)	VZSG-08C0-1 4	1220.36	1661.24
	18"(457mm)	VZSG-1218-1 4	\$ 416.15	\$ 473.47
	24"(610mm)	VZSG-1224-1 4	449.56	531.69
	30"(762mm)	VZSG-1230-1 4	482.97	589.91
	36"(914mm)	VZSG-1236-1 4	516.38	648.13
	42"(1067mm)	VZSG-1242-1 4	549.79	706.35
	48"(1219mm)	VZSG-1248-1 4	604.82	786.19
16"(406mm)	54"(1372mm)	VZSG-1254-1 4	638.23	844.41
	60"(1524mm)	VZSG-1260-1 4	671.64	902.63
	66"(1676mm)	VZSG-1266-1 4	705.05	960.85
	72"(1829mm)	VZSG-1272-1 4	939.09	1219.70
	78"(1981mm)	VZSG-1278-1 4	1047.42	1352.84
	84"(2134mm)	VZSG-1284-1 4	1080.83	1411.06
	90"(2286mm)	VZSG-1290-1 4	1114.24	1469.28
	96"(2438mm)	VZSG-1296-1 4	1147.65	1527.50
	102"(2591mm)	VZSG-12A2-1 4	1181.06	1585.72
	108"(2743mm)	VZSG-12A8-1 4	1214.47	1643.94
	114"(2896mm)	VZSG-12B4-1 4	1247.88	1702.16
	120"(3048mm)	VZSG-12C0-1 4	1281.29	1760.38
	18"(457mm)	VZSG-1618-1 4	\$ 455.46	\$ 550.99
	24"(610mm)	VZSG-1624-1 4	488.87	609.21
30"(762mm)	VZSG-1630-1 4	522.28	667.43	
36"(914mm)	VZSG-1636-1 4	555.69	725.65	
42"(1067mm)	VZSG-1642-1 4	589.10	783.87	
48"(1219mm)	VZSG-1648-1 4	701.12	920.70	
54"(1372mm)	VZSG-1654-1 4	734.53	978.92	
60"(1524mm)	VZSG-1660-1 4	767.94	1037.14	
66"(1676mm)	VZSG-1666-1 4	801.35	1095.36	
72"(1829mm)	VZSG-1672-1 4	1035.39	1354.21	
78"(1981mm)	VZSG-1678-1 4	1143.72	1487.35	
84"(2134mm)	VZSG-1684-1 4	1177.13	1545.57	
90"(2286mm)	VZSG-1690-1 4	1210.54	1603.79	
96"(2438mm)	VZSG-1696-1 4	1243.95	1662.01	
102"(2591mm)	VZSG-16A2-1 4	1277.36	1720.23	
108"(2743mm)	VZSG-16A8-1 4	1310.77	1778.45	
114"(2896mm)	VZSG-16B4-1 4	1344.18	1836.67	
120"(3048mm)	VZSG-16C0-1 4	1377.59	1894.89	

Gallery Panel Accessories

Topper Holder Kit

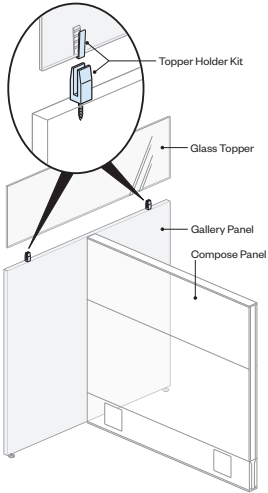

ZYST
Class BC

Features

- Includes brackets and attachment hardware for attaching one piece of glass to the top of a Gallery Panel.
- Field assembly to Gallery Panel.

Specification Tips

- For use with Gallery Panel. Separately specify 0.25”(6mm) thick Glass Topper or other field supplied glass.
- Topper Holder Kit and separately specified Glass Topper support centered or off-modular mounting on a Gallery Panel. Order one kit per Gallery Panel. Glass may span two or more Gallery Panels or be smaller than the mounting Gallery Panel.
- Not for use with “Glass Ready” Gallery Panel option.
- Refer to the Specification Guide for Topper Holder Kit and Glass Topper application guidelines.

To Order, Specify:

- 1) Product number.
- 2) Trim color.

Description	Quantity of Clips	Number	Trim	
			A	B
For Glass 72”(1829mm)W or less	2	VZST-2-4	\$ 131.35	\$ 136.35
For Glass greater than 72”(1829mm)W	3	VZST-3-4	197.03	202.03

Gallery Panel Accessories

Insert Glass

Nominal Height	Nominal Width	Number ① ②	Clear Glass (1C)	Satin Etch (E21)	Frosted Acrylic (1E)	
8"(203mm)	18"(457mm)	SYGG-0818- 4	\$ 465.73	\$ 848.54	\$ 1304.27	
	24"(610mm)	SYGG-0824- 4	498.99	909.74	1398.71	
	30"(762mm)	SYGG-0830- 4	532.25	970.94	1493.15	
	36"(914mm)	SYGG-0836- 4	565.51	1032.14	1587.59	
	42"(1067mm)	SYGG-0842- 4	598.77	1093.34	1682.03	
	48"(1219mm)	SYGG-0848- 4	632.03	1154.54	1776.47	
	54"(1372mm)	SYGG-0854- 4	665.29	1215.74	1870.91	
	60"(1524mm)	SYGG-0860- 4	698.55	1276.94	1965.35	
	66"(1676mm)	SYGG-0866- 4	731.81	1338.14	2059.79	
	72"(1829mm)	SYGG-0872- 4	765.07	1399.34	2154.23	
	78"(1981mm)	SYGG-0878- 4	798.33	1460.54	2248.67	
	84"(2134mm)	SYGG-0884- 4	831.59	1521.74	2343.11	
	90"(2286mm)	SYGG-0890- 4	864.85	1582.94	2437.55	
	96"(2438mm)	SYGG-0896- 4	898.11	1644.14	2531.99	
12"(305mm)	102"(2591mm)	SYGG-08A2- 4	931.37	1705.34	2626.43	
	108"(2743mm)	SYGG-08A8- 4	964.63	1766.54	2720.87	
	114"(2896mm)	SYGG-08B4- 4	997.89	1827.74	2815.31	
	120"(3048mm)	SYGG-08C0- 4	1031.15	1888.94	2909.75	
	12"(305mm)	18"(457mm)	SYGG-1218- 4	\$ 515.62	\$ 940.34	\$ 1445.93
		24"(610mm)	SYGG-1224- 4	565.51	1032.14	1587.59
		30"(762mm)	SYGG-1230- 4	615.40	1123.94	1729.25
		36"(914mm)	SYGG-1236- 4	665.29	1215.74	1870.91
		42"(1067mm)	SYGG-1242- 4	715.18	1307.54	2012.57
		48"(1219mm)	SYGG-1248- 4	765.07	1399.34	2154.23
		54"(1372mm)	SYGG-1254- 4	814.96	1491.14	2295.89
		60"(1524mm)	SYGG-1260- 4	864.85	1582.94	2437.55
		66"(1676mm)	SYGG-1266- 4	914.74	1674.74	2579.21
		72"(1829mm)	SYGG-1272- 4	964.63	1766.54	2720.87
78"(1981mm)		SYGG-1278- 4	1014.52	1858.34	2862.53	
84"(2134mm)		SYGG-1284- 4	1064.41	1950.14	3004.19	
90"(2286mm)		SYGG-1290- 4	1114.30	2041.94	3145.85	
96"(2438mm)		SYGG-1296- 4	1164.19	2133.74	3287.51	
16"(406mm)	102"(2591mm)	SYGG-12A2- 4	1214.08	2225.54	3429.17	
	108"(2743mm)	SYGG-12A8- 4	1263.97	2317.34	3570.83	
	114"(2896mm)	SYGG-12B4- 4	1313.86	2409.14	3712.49	
	120"(3048mm)	SYGG-12C0- 4	1363.75	2500.94	3854.15	
	16"(406mm)	18"(457mm)	SYGG-1618- 4	\$ 565.51	\$ 1032.14	\$ 1587.59
		24"(610mm)	SYGG-1624- 4	632.03	1154.54	1776.47
		30"(762mm)	SYGG-1630- 4	698.55	1276.94	1965.35
		36"(914mm)	SYGG-1636- 4	765.07	1399.34	2154.23
		42"(1067mm)	SYGG-1642- 4	831.59	1521.74	2343.11
		48"(1219mm)	SYGG-1648- 4	898.11	1644.14	2531.99
		54"(1372mm)	SYGG-1654- 4	964.63	1766.54	2720.87
		60"(1524mm)	SYGG-1660- 4	1031.15	1888.94	2909.75
		66"(1676mm)	SYGG-1666- 4	1097.67	2011.34	3098.63
		72"(1829mm)	SYGG-1672- 4	1164.19	2133.74	3287.51
78"(1981mm)		SYGG-1678- 4	1230.71	2256.14	3476.39	
84"(2134mm)		SYGG-1684- 4	1297.23	2378.54	3665.27	
90"(2286mm)		SYGG-1690- 4	1363.75	2500.94	3854.15	
96"(2438mm)		SYGG-1696- 4	1430.27	2623.34	4043.03	
16"(406mm)	102"(2591mm)	SYGG-16A2- 4	1496.79	2745.74	4231.91	
	108"(2743mm)	SYGG-16A8- 4	1563.31	2868.14	4420.79	
	114"(2896mm)	SYGG-16B4- 4	1629.83	2990.54	4609.67	
	120"(3048mm)	SYGG-16C0- 4	1696.35	3112.94	4798.55	

Gallery Panel Accessories

Compose Echo Tackboard

**For use with
Gallery Panels or
Wall Mount**

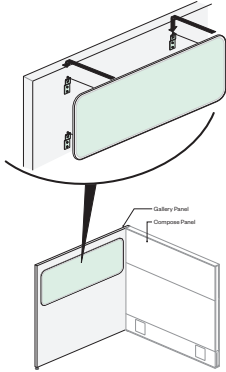

STUT
Class TR

Feature

- Includes one tackboard and mounting hardware.

Specification Tips

- Designed to mount on Compose Gallery Panels (Compose Price List) and Belong Gallery End Panels (Screens and Space Division Price List) or structural wall.
- Can be mounted using included mounting hardware or with separately specified Gallery Panel Hanging Bracket.
- Tackboard may:
 - span multiple Gallery Panels
 - be smaller than the Gallery Panel
 - be located off-modular.
- Fabric application guidelines:
 - 54"(1372mm)W rolls require railroad application on tackboards >52"(1321mm)
 - 60"(1524mm) and 66"(1676mm)W rolls require railroad application on tackboards >60"(1524mm)
- Dimensions shown are nominal dimensions. Actual width dimensions are 1" smaller than nominal.
- Refer to Specification Guide for details.

To Order, Specify:

- 1) Product number.
- 2) Fabric color.

Fabric

Height	Width	Number	A	B	C	D	E	F	G
12"(305mm)	18"(457mm)	STUT-1218-FNNUNS	\$ 159.14	\$ 175.72	\$ 193.96	\$ 213.85	\$ 233.75	\$260.28	\$ 276.86
	24"(610mm)	STUT-1224-FNNUNS	185.30	205.84	228.46	253.15	277.79	310.74	331.28
	30"(762mm)	STUT-1230-FNNUNS	211.46	235.96	262.96	292.45	321.83	361.20	385.70
	36"(914mm)	STUT-1236-FNNUNS	237.62	266.08	297.46	331.75	365.87	411.66	440.12
	42"(1067mm)	STUT-1242-FNNUNS	263.78	296.20	331.96	371.05	409.91	462.12	494.54
	48"(1219mm)	STUT-1248-FNNUNS	289.94	326.32	366.46	410.35	453.95	512.58	548.96
	54"(1372mm)	STUT-1254-FNNUNS	316.10	356.44	400.96	449.65	497.99	563.04	603.38
	60"(1524mm)	STUT-1260-FNNUNS	342.26	386.56	435.46	488.95	542.03	613.50	657.80
	66"(1676mm)	STUT-1266-FNNUNS	392.67	440.93	494.21	552.50	610.32	688.21	736.47
	72"(1829mm)	STUT-1272-FNNUNS	418.83	471.05	528.71	591.80	654.36	738.67	790.89
16"(406mm)	18"(457mm)	STUT-1618-FNNUNS	\$ 180.94	\$200.84	\$ 222.72	\$ 246.61	\$ 270.47	\$302.32	\$ 322.22
	24"(610mm)	STUT-1624-FNNUNS	207.10	230.96	257.22	285.91	314.51	352.78	376.64
	30"(762mm)	STUT-1630-FNNUNS	233.26	261.08	291.72	325.21	358.55	403.24	431.06
	36"(914mm)	STUT-1636-FNNUNS	259.42	291.20	326.22	364.51	402.59	453.70	485.48
	42"(1067mm)	STUT-1642-FNNUNS	285.58	321.32	360.72	403.81	446.63	504.16	539.90
	48"(1219mm)	STUT-1648-FNNUNS	311.74	351.44	395.22	443.11	490.67	554.62	594.32
	54"(1372mm)	STUT-1654-FNNUNS	337.90	381.56	429.72	482.41	534.71	605.08	648.74
	60"(1524mm)	STUT-1660-FNNUNS	364.06	411.68	464.22	521.71	578.75	655.54	703.16
	66"(1676mm)	STUT-1666-FNNUNS	414.47	466.05	522.97	585.26	647.04	730.25	781.83
	72"(1829mm)	STUT-1672-FNNUNS	440.63	496.17	557.47	624.56	691.08	780.71	836.25
24"(610mm)	18"(457mm)	STUT-2418-FNNUNS	\$ 224.54	\$ 251.08	\$ 280.24	\$ 312.13	\$ 343.91	\$386.40	\$ 412.94
	24"(610mm)	STUT-2424-FNNUNS	250.70	281.20	314.74	351.43	387.95	436.86	467.36
	30"(762mm)	STUT-2430-FNNUNS	276.86	311.32	349.24	390.73	431.99	487.32	521.78
	36"(914mm)	STUT-2436-FNNUNS	303.02	341.44	383.74	430.03	476.03	537.78	576.20
	42"(1067mm)	STUT-2442-FNNUNS	329.18	371.56	418.24	469.33	520.07	588.24	630.62
	48"(1219mm)	STUT-2448-FNNUNS	355.34	401.68	452.74	508.63	564.11	638.70	685.04
	54"(1372mm)	STUT-2454-FNNUNS	381.50	431.80	487.24	547.93	608.15	689.16	739.46
	60"(1524mm)	STUT-2460-FNNUNS	407.66	461.92	521.74	587.23	652.19	739.62	793.88
	66"(1676mm)	STUT-2466-FNNUNS	458.07	516.29	580.49	650.78	720.48	814.33	872.55
	72"(1829mm)	STUT-2472-FNNUNS	484.23	546.41	614.99	690.08	764.52	864.79	926.97
84"(2134mm)	78"(1981mm)	STUT-2478-FNNUNS	510.39	576.53	649.49	729.38	808.56	915.25	981.39
	84"(2134mm)	STUT-2484-FNNUNS	536.55	606.65	683.99	768.68	852.60	965.71	1035.81

Gallery Panel Accessories

Compose Tile Hardware Kit

For use with Gallery Panels or Wall Mount

- Includes six mounting brackets and mounting hardware for attaching one Compose Tile to a Gallery Panel.
- Hardware kit is specific to the tile type being mounted; specify accordingly.

To Order, Specify:

- 1) Product number.
(No finish specification required.)

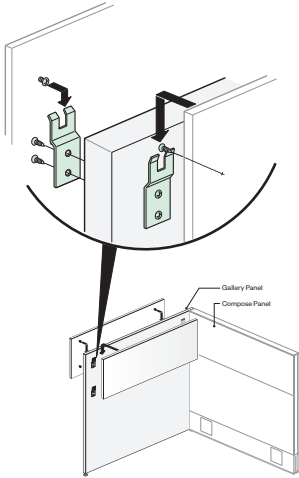

SYTI
Class BC

Description	Number	Price
Fabric	SYTI-0000-F	\$ 75.00
Markerboard	SYTI-0000-M	150.00

Gallery Panel Accessories

Gallery Panel Hanging Brackets

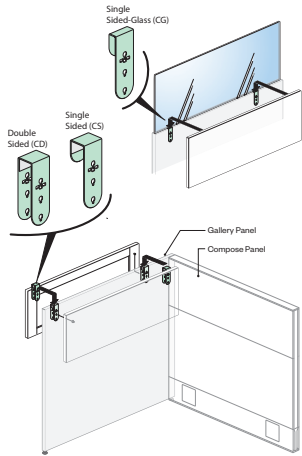

SYWB
Class BC – GSA; Open Market

Features

- Includes one bracket.
- Brackets allow attachment of components to Gallery Panel without leaving holes in the Gallery Panel.

Specification Tips

- Designed to mount on Compose Gallery Panels (Compose Price List) and Belong Gallery End Panels (Screens and Space Division Price List).
- **Single and Double Sided Finished Top brackets are designed for use on a Gallery Panel finished top.** Not for use with Compose Gallery Panels specified with Glass Ready option. Not recommended for use with Topper Kit due to installation sequence.
- **Single Sided - Inset/Frameless Glass Bracket is designed for use on Compose Gallery Panels with Glass Ready option only.**
- Designed to hang the following, separately specified, components found in the Compose Price List:
 - Compose Fabric Tile (VZTI-FNN)
 - Compose Markerboard Tile (VZTI-MNN)
 - Wall Mount Tackboard (KUAF)
 - Wall Mount Markerboard (KUAM)
 - Compose Echo Tackboard (STUT)
- See Application Guide for vertical and horizontal offset by component.
- Bracket supported components may span more than one in-line Gallery Panel. Bracket can mount on a Gallery Panel in-line seam.
 - Use two brackets per component. Use three brackets if component is 72”(1829mm) and greater.
- When using Double Sided Bracket, components must be the same on both sides. Cannot mix components.

To Order, Specify:

- 1) Product number.
- 2) Trim color.

Description	Number	Trim	
		A	B
Single Sided - Finished Top	SYWB-0000-CS	\$45.00	\$50.00
Double Sided - Finished Top	SYWB-0000-CD	50.00	55.00
Single Sided - Inset/Frameless Glass	SYWB-0000-CG	47.00	52.00

Gallery Panel Accessories

Trim Post

Variable Height — Intermediate Intersection

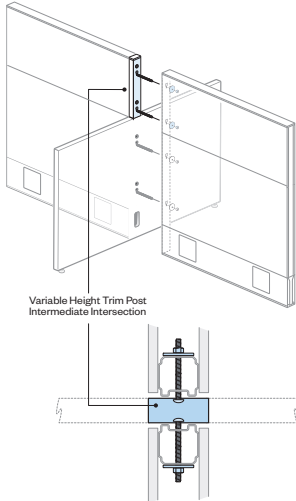

SYPX
Class BC

Feature

- Variable height post with steel or aluminum top cap and attachment hardware.

Specification Tips

- For use between two Compose panels of the same height and a shorter intermediate Gallery Panel application.
- Not for use with Compose Glass Panels.
- Trim Post height is the difference between Compose panel and Gallery Panel(s).
- Mixing Steel top trim with Aluminum top trim is not recommended.
- Refer to Specification Guide for Planning with Gallery Panel Variable Height Trim Posts.

To Order, Specify:

- 1) Product number, including:

1 Top Cap Options

- H** Steel
- A** Aluminum

- 2) Trim color for post.
- 3) Trim color for top cap.

Height	Number ①	Steel (H) Trim		Aluminum (A) Trim	
		A	B	A	B
Intermediate Intersection					
8"(203mm)	SYPX-0800- V	\$ 319.60	\$ 327.61	\$ 367.47	\$ 375.48
16"(406mm)	SYPX-1600- V	409.09	420.10	456.96	467.97
24"(610mm)	SYPX-2400- V	498.59	512.60	546.46	560.47
32"(813mm)	SYPX-3200- V	588.08	605.08	635.95	652.95

Gallery Panel Accessories

Trim Post

3-Way or 4-Way — Intermediate Full Height

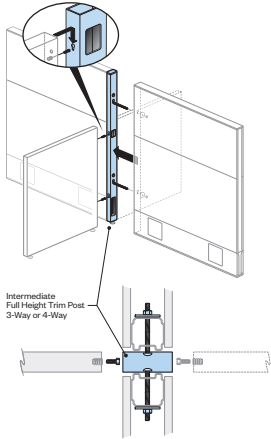

SYPT
Class BC

Feature

- Includes steel or aluminum variable height (Proud) post, cap and attachment hardware.

Specification Tips

- For intermediate use between two Compose panel frames of the same height.
- Not for use with Compose Glass Panels.
- Full Height Trim Post attaches to one (3-way) or two (4-way) Gallery Panel(s) on the End(s).
- Trim Post must match height of connecting Compose panel frames:
 - Select connection height to match attaching Gallery Panel height.
 - In 4-way conditions both Gallery Panels must be the same height.
 - Refer to the Specification Guide for Full Height Trim Post and End mounting application guidelines.
- Select top cap option to match trim on surrounding Compose panels.
- Gallery Panel may not be taller than the Intermediate Full Height Trim Post.
- Base power applications require separately specified Flexible Power Connector - Panel-to-Panel, Work-height (VZEF-OBOP-_)

To Order, Specify:

- 1) Product number, including:

1 Trim Option

- H** Steel
- A** Aluminum

- 2) Trim color for post.
- 3) Trim color for top cap.

Post Height	Gallery Panel Connection Height	Number ①	Steel (H) Trim		Aluminum (A) Trim	
			A	B	A	B
Intermediate 3-Way Intersection						
34"(864mm)	26"(660mm)	SYPT-3426- C	\$660.56	\$ 678.32	\$ 708.43	\$ 726.19
	34"(864mm)	SYPT-3434- C	660.56	678.32	708.43	726.19
42"(1067mm)	26"(660mm)	SYPT-4226- C	\$ 750.05	\$ 770.80	\$ 797.92	\$ 818.67
	34"(864mm)	SYPT-4234- C	750.05	770.80	797.92	818.67
	42"(1067mm)	SYPT-4242- C	750.05	770.80	797.92	818.67
50"(1270mm)	26"(660mm)	SYPT-5026- C	\$ 839.55	\$ 863.30	\$ 887.42	\$ 911.17
	34"(864mm)	SYPT-5034- C	839.55	863.30	887.42	911.17
	42"(1067mm)	SYPT-5042- C	839.55	863.30	887.42	911.17
	50"(1270mm)	SYPT-5050- C	839.55	863.30	887.42	911.17
58"(1473mm)	26"(660mm)	SYPT-5826- C	\$ 929.48	\$ 956.24	\$ 977.35	\$ 1004.11
	34"(864mm)	SYPT-5834- C	929.48	956.24	977.35	1004.11
	42"(1067mm)	SYPT-5842- C	929.48	956.24	977.35	1004.11
	50"(1270mm)	SYPT-5850- C	929.48	956.24	977.35	1004.11
	58"(1473mm)	SYPT-5858- C	929.48	956.24	977.35	1004.11
66"(1676mm)	26"(660mm)	SYPT-6626- C	\$1018.97	\$1048.73	\$1066.84	\$1096.60
	34"(864mm)	SYPT-6634- C	1018.97	1048.73	1066.84	1096.60
	42"(1067mm)	SYPT-6642- C	1018.97	1048.73	1066.84	1096.60
	50"(1270mm)	SYPT-6650- C	1018.97	1048.73	1066.84	1096.60
	58"(1473mm)	SYPT-6658- C	1018.97	1048.73	1066.84	1096.60
74"(1880mm)	26"(660mm)	SYPT-7426- C	\$1108.46	\$ 1141.22	\$ 1156.33	\$ 1189.09
	34"(864mm)	SYPT-7434- C	1108.46	1141.22	1156.33	1189.09
	42"(1067mm)	SYPT-7442- C	1108.46	1141.22	1156.33	1189.09
	50"(1270mm)	SYPT-7450- C	1108.46	1141.22	1156.33	1189.09
	58"(1473mm)	SYPT-7458- C	1108.46	1141.22	1156.33	1189.09
	74"(1880mm)	SYPT-7474- C	1108.46	1141.22	1156.33	1189.09
82"(2083mm)	26"(660mm)	SYPT-8226- C	\$ 1197.95	\$1233.70	\$ 1245.82	\$ 1281.57
	34"(864mm)	SYPT-8234- C	1197.95	1233.70	1245.82	1281.57
	42"(1067mm)	SYPT-8242- C	1197.95	1233.70	1245.82	1281.57
	50"(1270mm)	SYPT-8250- C	1197.95	1233.70	1245.82	1281.57
	58"(1473mm)	SYPT-8258- C	1197.95	1233.70	1245.82	1281.57
90"(2286mm)	26"(660mm)	SYPT-9026- C	\$1287.45	\$1326.20	\$ 1335.32	\$ 1374.07
	34"(864mm)	SYPT-9034- C	1287.45	1326.20	1335.32	1374.07
	42"(1067mm)	SYPT-9042- C	1287.45	1326.20	1335.32	1374.07
	50"(1270mm)	SYPT-9050- C	1287.45	1326.20	1335.32	1374.07
	58"(1473mm)	SYPT-9058- C	1287.45	1326.20	1335.32	1374.07

Gallery Panel Accessories

Trim Post

Post Height	Gallery Panel Post Height	Number ①	Steel (H) Trim		Aluminum (A) Trim	
			A	B	A	B
Intermediate 4-Way Intersection						
34"(864mm)	26"(660mm)	SYPX-3426- C	\$660.56	\$ 678.32	\$ 708.43	\$ 726.19
	34"(864mm)	SYPX-3434- C	660.56	678.32	708.43	726.19
42"(1067mm)	26"(660mm)	SYPX-4226- C	\$ 750.05	\$ 770.80	\$ 797.92	\$ 818.67
	34"(864mm)	SYPX-4234- C	750.05	770.80	797.92	818.67
	42"(1067mm)	SYPX-4242- C	750.05	770.80	797.92	818.67
50"(1270mm)	26"(660mm)	SYPX-5026- C	\$ 839.55	\$ 863.30	\$ 887.42	\$ 911.17
	34"(864mm)	SYPX-5034- C	839.55	863.30	887.42	911.17
	42"(1067mm)	SYPX-5042- C	839.55	863.30	887.42	911.17
	50"(1270mm)	SYPX-5050- C	839.55	863.30	887.42	911.17
58"(1473mm)	26"(660mm)	SYPX-5826- C	\$ 929.48	\$ 956.24	\$ 977.35	\$ 1004.11
	34"(864mm)	SYPX-5834- C	929.48	956.24	977.35	1004.11
	42"(1067mm)	SYPX-5842- C	929.48	956.24	977.35	1004.11
	50"(1270mm)	SYPX-5850- C	929.48	956.24	977.35	1004.11
	58"(1473mm)	SYPX-5858- C	929.48	956.24	977.35	1004.11
66"(1676mm)	26"(660mm)	SYPX-6626- C	\$1018.97	\$1048.73	\$1066.84	\$1096.60
	34"(864mm)	SYPX-6634- C	1018.97	1048.73	1066.84	1096.60
	42"(1067mm)	SYPX-6642- C	1018.97	1048.73	1066.84	1096.60
	50"(1270mm)	SYPX-6650- C	1018.97	1048.73	1066.84	1096.60
	58"(1473mm)	SYPX-6666- C	1018.97	1048.73	1066.84	1096.60
74"(1880mm)	26"(660mm)	SYPX-7426- C	\$1108.46	\$ 1141.22	\$ 1156.33	\$ 1189.09
	34"(864mm)	SYPX-7434- C	1108.46	1141.22	1156.33	1189.09
	42"(1067mm)	SYPX-7442- C	1108.46	1141.22	1156.33	1189.09
	50"(1270mm)	SYPX-7450- C	1108.46	1141.22	1156.33	1189.09
	58"(1473mm)	SYPX-7474- C	1108.46	1141.22	1156.33	1189.09
82"(2083mm)	26"(660mm)	SYPX-8226- C	\$ 1197.95	\$ 1233.70	\$ 1245.82	\$ 1281.57
	34"(864mm)	SYPX-8234- C	1197.95	1233.70	1245.82	1281.57
	42"(1067mm)	SYPX-8242- C	1197.95	1233.70	1245.82	1281.57
	50"(1270mm)	SYPX-8250- C	1197.95	1233.70	1245.82	1281.57
	58"(1473mm)	SYPX-8282- C	1197.95	1233.70	1245.82	1281.57
90"(2286mm)	26"(660mm)	SYPX-9026- C	\$1287.45	\$1326.20	\$ 1335.32	\$ 1374.07
	34"(864mm)	SYPX-9034- C	1287.45	1326.20	1335.32	1374.07
	42"(1067mm)	SYPX-9042- C	1287.45	1326.20	1335.32	1374.07
	50"(1270mm)	SYPX-9050- C	1287.45	1326.20	1335.32	1374.07
	58"(1473mm)	SYPX-9058- C	1287.45	1326.20	1335.32	1374.07

Adaptable Worksurfaces — Rectangular

General Specifications



WURA
Rectangular



WURT-N43
WURT-N34
Rectangular Transition



WURS
Rectangular Swell



WURW
Rectangular Inverse Swell

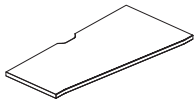

WURE-N34
WURE-N43
Wedge

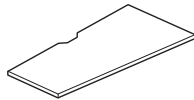

WURG-N34
WURG-N43
Sharp Wedge



WURR
Rectangular Radius End

- Includes work surface and tie plate.
- Available in high-pressure laminate (HPL) or wood veneer.
- Laminate edge option:
 - (J) 3mm edgeband on user side with 1mm edgeband on sides and back.
 - (F) Knife edge on user side and 1mm edgeband on sides and back.
- Wood veneer edge option:
 - (K) 3mm edgeband on user side with 1mm edgeband on sides and back.
 - (U) Knife edge on user side and 1mm edgeband on sides and back.
- Worksurfaces predrilled to accept most support options. 36"(914mm)W and above are predrilled for pedestals.
- Optional wireway:
 - 24"(610mm)W-60"(1524mm)W worksurfaces have one wireway centered on back edge.
 - Worksurfaces wider than 60"(1524mm) have two wireways on back edge.
 - Wireway will be color-matched to solid side/back edge trim. Wood veneer or patterned/wood grain laminate will have a Charcoal wireway.
 - Refer to Specification Guide for wireway details.
- Optional Belong Hatch cutout:
 - Laminate tops only with one cutout.
 - Available on worksurfaces 30"(762mm)D and widths 42"(1067mm), 48"(1219mm), 51"(1295mm), 54"(1372mm) and 60"(1524mm).
 - Requires separately specified Belong Hatch.
 - Refer to Specification Guide for cutout details.
- **Installed worksurfaces without wireway will not allow clearance for power plug.**
- Depths and widths shown in nominal dimensions.

Specification Tips

- **Work surface support specific to product line and work surface edge guidelines; must be separately specified.**
- Knife edge requires use of work surface supports for that application; work surface support panel and/or side bracket for use with knife edge.
- Intermediate support is required for unsupported work surface span greater than 60"(1524mm).
- Not intended for use on Height Adjustable Tables.

Note: Separately specified work surface reinforcement bar provides additional support for worksurfaces with 60"(1524mm) spans that are heavily loaded and not otherwise supported by mid-span cantilevers, work surface support panels, columns, legs or attached lower storage.

Adaptable Worksurfaces — Rectangular

Rectangular

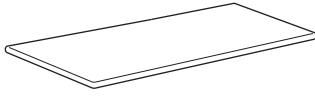

WURA
Class CA

To Order, Specify:

1) Product number, including:

1 Surface Option:

- L** Laminate
- W** Wood

2 Edge Option:

Laminate:

- J** Edgeband
- F** Knife

Wood:

- K** Edgeband
- U** Knife

3 Wireway/Cutout Option:

- A** Notched
- C** Without
- H** Belong Hatch

2) Laminate color or Wood finish color.

3) Edge trim color (laminite only).

Depth	Width	Number ①②③	HPL Edgeband (J)			HPL Knife Edge (F)			Wood Edgeband (K)		Wood Knife Edge (U)	
			A	B	E	A	B	E	A	B	A	B
18"(457mm)	24"(610mm)	WURA-1824- S	\$ 397.40	\$ 420.74	\$ 489.03	\$ 718.45	\$ 741.79	\$ 810.08	\$ 684.21	\$ 725.84	\$ 948.64	\$ 990.27
	27"(686mm)	WURA-1827- S	415.88	440.99	514.86	742.21	767.32	841.19	731.67	775.82	1005.48	1049.63
	30"(762mm)	WURA-1830- S	435.20	462.08	541.53	769.45	796.33	875.78	779.13	825.80	1067.01	1113.68
	33"(838mm)	WURA-1833- S	454.52	483.17	568.20	796.69	825.34	910.37	826.59	875.78	1128.54	1177.73
	36"(914mm)	WURA-1836- S	473.84	504.26	594.87	823.93	854.35	944.96	874.05	925.76	1190.07	1241.78
	39"(991mm)	WURA-1839- S	493.16	525.35	621.54	851.17	883.36	979.55	921.51	975.74	1251.60	1305.83
	42"(1067mm)	WURA-1842- S	512.48	546.44	648.21	878.41	912.37	1014.14	968.97	1025.72	1313.13	1369.88
	45"(1143mm)	WURA-1845- S	531.80	567.53	674.88	905.65	941.38	1048.73	1016.43	1075.70	1374.66	1433.93
	48"(1219mm)	WURA-1848- S	604.42	641.92	754.85	986.19	1023.69	1136.62	1172.19	1233.98	1544.49	1606.28
	51"(1295mm)	WURA-1851- S	623.74	663.01	781.52	1013.43	1052.70	1171.21	1219.65	1283.96	1606.02	1670.33
	54"(1372mm)	WURA-1854- S	643.06	684.10	808.19	1040.67	1081.71	1205.80	1267.11	1333.94	1667.55	1734.38
	57"(1448mm)	WURA-1857- S	662.38	705.19	834.86	1067.91	1110.72	1240.39	1314.57	1383.92	1729.08	1798.43
	60"(1524mm)	WURA-1860- S	681.70	726.28	861.53	1095.15	1139.73	1274.98	1362.03	1433.90	1790.61	1862.48
	63"(1600mm)	WURA-1863- S	701.02	747.37	888.20	1122.39	1168.74	1309.57	1409.49	1483.88	1852.14	1926.53
	66"(1676mm)	WURA-1866- S	720.34	768.46	914.87	1149.63	1197.75	1344.16	1456.95	1533.86	1913.67	1990.58
	69"(1753mm)	WURA-1869- S	739.66	789.55	941.54	1176.87	1226.76	1378.75	1504.41	1583.84	1975.20	2054.63
	72"(1829mm)	WURA-1872- S	758.98	810.64	968.21	1204.11	1255.77	1413.34	1551.87	1633.82	2036.73	2118.68
	75"(1905mm)	WURA-1875- S	778.30	831.73	994.88	1231.35	1284.78	1447.93	1599.33	1683.80	2098.26	2182.73
	78"(1981mm)	WURA-1878- S	797.62	852.82	1021.55	1258.59	1313.79	1482.52	1646.79	1733.78	2159.79	2246.78
	81"(2057mm)	WURA-1881- S	816.94	873.91	1048.22	1285.83	1342.80	1517.11	1694.25	1783.76	2221.32	2310.83
	84"(2134mm)	WURA-1884- S	836.26	895.00	1074.89	1313.07	1371.81	1551.70	1741.71	1833.74	2282.85	2374.88
	87"(2210mm)	WURA-1887- S	855.58	916.09	1101.56	1340.31	1400.82	1586.29	1789.17	1883.72	2344.38	2438.93
	90"(2286mm)	WURA-1890- S	874.90	937.18	1128.23	1367.55	1429.83	1620.88	1836.63	1933.70	2405.91	2502.98
	93"(2362mm)	WURA-1893- S	894.22	958.27	1154.90	1394.79	1458.84	1655.47	1884.09	1983.68	2467.44	2567.03
	96"(2438mm)	WURA-1896- S	913.54	979.36	1181.57	1422.03	1487.85	1690.06	1931.55	2033.66	2528.97	2631.08
	99"(2515mm)	WURA-1899- S	932.86	1000.45	1208.24	1449.27	1516.86	1724.65	1979.01	2083.64	2590.50	2695.13
	102"(2591mm)	WURA-18A2- S	952.18	1021.54	1234.91	1476.51	1545.87	1759.24	2026.47	2133.62	2652.03	2759.18
	105"(2667mm)	WURA-18A5- S	971.50	1042.63	1261.58	1503.75	1574.88	1793.83	2073.93	2183.60	2713.56	2823.23
	108"(2743mm)	WURA-18A8- S	990.82	1063.72	1288.25	1530.99	1603.89	1828.42	2121.39	2233.58	2775.09	2887.28
	111"(2819mm)	WURA-18B1- S	1010.14	1084.81	1314.92	1558.23	1632.90	1863.01	2168.85	2283.56	2836.62	2951.33
	114"(2896mm)	WURA-18B4- S	1029.46	1105.90	1341.59	1585.47	1661.91	1897.60	2216.31	2333.54	2898.15	3015.38
	117"(2972mm)	WURA-18B7- S	1048.78	1126.99	1368.26	1612.71	1690.92	1932.19	2263.77	2383.52	2959.68	3079.43
	120"(3048mm)	WURA-18C0- S	1068.10	1148.08	1394.93	1639.95	1719.93	1966.78	2311.23	2433.50	3021.21	3143.48

Adaptable Worksurfaces — Rectangular

Rectangular

Depth	Width	Number ①②③	HPL Edgeband (J)			HPL Knife Edge (F)			Wood Edgeband (K)		Wood Knife Edge (U)		
			A	B	E	A	B	E	A	B	A	B	
24"(610mm)	24"(610mm)	WURA-2424-	S	\$ 389.03	\$ 412.37	\$ 480.66	\$ 743.27	\$ 766.61	\$ 834.90	\$ 750.83	\$ 792.46	\$ 1040.01	\$ 1081.64
	27"(686mm)	WURA-2427-	S	414.41	439.52	513.39	773.93	799.04	872.91	803.24	847.39	1101.80	1145.95
	30"(762mm)	WURA-2430-	S	440.63	467.51	546.96	808.07	834.95	914.40	855.65	902.32	1168.28	1214.95
	33"(838mm)	WURA-2433-	S	466.85	495.50	580.53	842.21	870.86	955.89	908.06	957.25	1234.76	1283.95
	36"(914mm)	WURA-2436-	S	493.07	523.49	614.10	876.35	906.77	997.38	960.47	1012.18	1301.24	1352.95
	39"(991mm)	WURA-2439-	S	519.29	551.48	647.67	910.49	942.68	1038.87	1012.88	1067.11	1367.72	1421.95
	42"(1067mm)	WURA-2442-	S	545.51	579.47	681.24	944.63	978.59	1080.36	1065.29	1122.04	1434.20	1490.95
	45"(1143mm)	WURA-2445-	S	571.73	607.46	714.81	978.77	1014.50	1121.85	1117.70	1176.97	1500.68	1559.95
	48"(1219mm)	WURA-2448-	S	651.25	688.75	801.68	1066.21	1103.71	1216.64	1278.41	1340.20	1675.46	1737.25
	51"(1295mm)	WURA-2451-	S	677.47	716.74	835.25	1100.35	1139.62	1258.13	1330.82	1395.13	1741.94	1806.25
	54"(1372mm)	WURA-2454-	S	703.69	744.73	868.82	1134.49	1175.53	1299.62	1383.23	1450.06	1808.42	1875.25
	57"(1448mm)	WURA-2457-	S	729.91	772.72	902.39	1168.63	1211.44	1341.11	1435.64	1504.99	1874.90	1944.25
	60"(1524mm)	WURA-2460-	S	756.13	800.71	935.96	1202.77	1247.35	1382.60	1488.05	1559.92	1941.38	2013.25
	63"(1600mm)	WURA-2463-	S	782.35	828.70	969.53	1236.91	1283.26	1424.09	1540.46	1614.85	2007.86	2082.25
	66"(1676mm)	WURA-2466-	S	808.57	856.69	1003.10	1271.05	1319.17	1465.58	1592.87	1669.78	2074.34	2151.25
	69"(1753mm)	WURA-2469-	S	834.79	884.68	1036.67	1305.19	1355.08	1507.07	1645.28	1724.71	2140.82	2220.25
	72"(1829mm)	WURA-2472-	S	861.01	912.67	1070.24	1339.33	1390.99	1548.56	1697.69	1779.64	2207.30	2289.25
	75"(1905mm)	WURA-2475-	S	887.23	940.66	1103.81	1373.47	1426.90	1590.05	1750.10	1834.57	2273.78	2358.25
	78"(1981mm)	WURA-2478-	S	913.45	968.65	1137.38	1407.61	1462.81	1631.54	1802.51	1889.50	2340.26	2427.25
	81"(2057mm)	WURA-2481-	S	939.67	996.64	1170.95	1441.75	1498.72	1673.03	1854.92	1944.43	2406.74	2496.25
	84"(2134mm)	WURA-2484-	S	965.89	1024.63	1204.52	1475.89	1534.63	1714.52	1907.33	1999.36	2473.22	2565.25
	87"(2210mm)	WURA-2487-	S	992.11	1052.62	1238.09	1510.03	1570.54	1756.01	1959.74	2054.29	2539.70	2634.25
	90"(2286mm)	WURA-2490-	S	1018.33	1080.61	1271.66	1544.17	1606.45	1797.50	2012.15	2109.22	2606.18	2703.25
	93"(2362mm)	WURA-2493-	S	1044.55	1108.60	1305.23	1578.31	1642.36	1838.99	2064.56	2164.15	2672.66	2772.25
	96"(2438mm)	WURA-2496-	S	1070.77	1136.59	1338.80	1612.45	1678.27	1880.48	2116.97	2219.08	2739.14	2841.25
	99"(2515mm)	WURA-2499-	S	1096.99	1164.58	1372.37	1646.59	1714.18	1921.97	2169.38	2274.01	2805.62	2910.25
	102"(2591mm)	WURA-24A2-	S	1123.21	1192.57	1405.94	1680.73	1750.09	1963.46	2221.79	2328.94	2872.10	2979.25
	105"(2667mm)	WURA-24A5-	S	1149.43	1220.56	1439.51	1714.87	1786.00	2004.95	2274.20	2383.87	2938.58	3048.25
	108"(2743mm)	WURA-24A8-	S	1175.65	1248.55	1473.08	1749.01	1821.91	2046.44	2326.61	2438.80	3005.06	3117.25
	111"(2819mm)	WURA-24B1-	S	1201.87	1276.54	1506.65	1783.15	1857.82	2087.93	2379.02	2493.73	3071.54	3186.25
114"(2896mm)	WURA-24B4-	S	1228.09	1304.53	1540.22	1817.29	1893.73	2129.42	2431.43	2548.66	3138.02	3255.25	
117"(2972mm)	WURA-24B7-	S	1254.31	1332.52	1573.79	1851.43	1929.64	2170.91	2483.84	2603.59	3204.50	3324.25	
120"(3048mm)	WURA-24C0-	S	1280.53	1360.51	1607.36	1885.57	1965.55	2212.40	2536.25	2658.52	3270.98	3393.25	
30"(762mm)	24"(610mm)	WURA-3024-	S	\$ 430.67	\$ 454.01	\$ 522.30	\$ 917.54	\$ 940.88	\$ 1009.17	\$ 1099.91	\$ 1141.54	\$ 1479.79	\$ 1521.42
	27"(686mm)	WURA-3027-	S	458.57	483.68	557.55	950.72	975.83	1049.70	1157.42	1201.57	1546.68	1590.83
	30"(762mm)	WURA-3030-	S	487.31	514.19	593.64	987.38	1014.26	1093.71	1214.93	1261.60	1618.26	1664.93
	33"(838mm)	WURA-3033-	S	516.05	544.70	629.73	1024.04	1052.69	1137.72	1272.44	1321.63	1689.84	1739.03
	36"(914mm)	WURA-3036-	S	544.79	575.21	665.82	1060.70	1091.12	1181.73	1329.95	1381.66	1761.42	1813.13
	39"(991mm)	WURA-3039-	S	573.53	605.72	701.91	1097.36	1129.55	1225.74	1387.46	1441.69	1833.00	1887.23
	42"(1067mm)	WURA-3042-	S	602.27	636.23	738.00	1134.02	1167.98	1269.75	1444.97	1501.72	1904.58	1961.33
	45"(1143mm)	WURA-3045-	S	631.01	666.74	774.09	1170.68	1206.41	1313.76	1502.48	1561.75	1976.16	2035.43
	48"(1219mm)	WURA-3048-	S	713.05	760.55	863.48	1260.64	1298.14	1411.07	1668.29	1730.08	2156.04	2217.83
	51"(1295mm)	WURA-3051-	S	741.79	781.06	899.57	1297.30	1336.57	1455.08	1725.80	1790.11	2227.62	2291.93
	54"(1372mm)	WURA-3054-	S	770.53	811.57	935.66	1333.96	1375.00	1499.09	1783.31	1850.14	2299.20	2366.03
	57"(1448mm)	WURA-3057-	S	799.27	842.08	971.75	1370.62	1413.43	1543.10	1840.82	1910.17	2370.78	2440.13
	60"(1524mm)	WURA-3060-	S	828.01	872.59	1007.84	1407.28	1451.86	1587.11	1898.33	1970.20	2442.36	2514.23
	63"(1600mm)	WURA-3063-	S	856.75	903.10	1043.93	1443.94	1490.29	1631.12	1955.84	2030.23	2513.94	2588.33
	66"(1676mm)	WURA-3066-	S	885.49	933.61	1080.02	1480.60	1528.72	1675.13	2013.35	2090.26	2585.52	2662.43
	69"(1753mm)	WURA-3069-	S	914.23	964.12	1116.11	1517.26	1567.15	1719.14	2070.86	2150.29	2657.10	2736.53
	72"(1829mm)	WURA-3072-	S	942.97	994.63	1152.20	1553.92	1605.58	1763.15	2128.37	2210.32	2728.68	2810.63
	75"(1905mm)	WURA-3075-	S	971.71	1025.14	1188.29	1590.58	1644.01	1807.16	2185.88	2270.35	2800.26	2884.73
	78"(1981mm)	WURA-3078-	S	1000.45	1055.65	1224.38	1627.24	1682.44	1851.17	2243.39	2330.38	2871.84	2958.83
	81"(2057mm)	WURA-3081-	S	1029.19	1086.16	1260.47	1663.90	1720.87	1895.18	2300.90	2390.41	2943.42	3032.93
	84"(2134mm)	WURA-3084-	S	1057.93	1116.67	1296.56	1700.56	1759.30	1939.19	2358.41	2450.44	3015.00	3107.03
	87"(2210mm)	WURA-3087-	S	1086.67	1147.18	1332.65	1737.22	1797.73	1983.20	2415.92	2510.47	3086.58	3181.13
	90"(2286mm)	WURA-3090-	S	1115.41	1177.69	1368.74	1773.88	1836.16	2027.21	2473.43	2570.50	3158.16	3255.23
	93"(2362mm)	WURA-3093-	S	1144.15	1208.20	1404.83	1810.54	1874.59	2071.22	2530.94	2630.53	3229.74	3329.33
	96"(2438mm)	WURA-3096-	S	1172.89	1238.71	1440.92	1847.20	1913.02	2115.23	2588.45	2690.56	3301.32	3403.43
	99"(2515mm)	WURA-3099-	S	1201.63	1269.22	1477.01	1883.86	1951.45	2159.24	2645.96	2750.59	3372.90	3477.53
	102"(2591mm)	WURA-30A2-	S	1230.37	1299.73	1513.10	1920.52	1989.88	2203.25	2703.47	2810.62	3444.48	3551.63
	105"(2667mm)	WURA-30A5-	S	1259.11	1330.24	1549.19	1957.18	2028.31	2247.26	2760.98	2870.65	3516.06	3625.73
	108"(2743mm)	WURA-30A8-	S	1287.85	1360.75	1585.28	1993.84	2066.74	2291.27	2818.49	2930.68	3587.64	3699.83
	111"(2819mm)	WURA-30B1-	S	1316.59	1391.26	1621.37	2030.50	2105.17	2335.28	2876.00	2990.71	3659.22	3773.93
114"(2896mm)	WURA-30B4-	S	1345.33	1421.77	1657.46	2067.16	2143.60	2379.29	2933.51	3050.74	3730.80	3848.03	
117"(2972mm)	WURA-30B7-	S	1374.07	1452.28	1693.55	2103.82	2182.03	2423.30	2991.02	3107.77	3802.38	3922.13	
120"(3048mm)	WURA-30C0-	S	1402.81	1482.79	1729.64	2140.48	2220.46	2467.31	3048.53	3170.80	3873.96	3996.23	

Adaptable Worksurfaces — Rectangular

Rectangular Transition



WURT-N43



WURT-N34
Class CA

Unique Specifications

- Worksurface less than 42"(1067mm)W suggested pedestal style is mobile.
- Worksurfaces greater than 42"(1067mm)W attached pedestal may be installed on deepest side.

To Order, Specify:

1) Product number, including:

1 Surface Option:

- L** Laminate
- W** Wood

2 Edge Option:

Laminate:

- J** Edgeband
- F** Knife

Wood:

- K** Edgeband
- U** Knife

3 Wireway Option:

- A** Notched
- C** Without

2) Laminate color or Wood finish color.

3) Edge trim color (laminite only).

Left/Right Depth	Width	Number 1 2 3	HPL Edgeband (J)			HPL Knife Edge (F)			Wood Edgeband (K)		Wood Knife Edge (U)	
			A	B	E	A	B	E	A	B	A	B
24"(610mm)/18"(457mm)	24"(610mm)	WURT-2424- S N43	\$ 457.11	\$490.57	\$ 595.23	\$ 707.41	\$ 740.87	\$ 845.53	\$1032.69	\$1082.94	\$ 1386.31	\$ 1436.56
	30"(762mm)	WURT-2430- S N43	515.55	553.03	671.37	783.97	821.45	939.79	1153.35	1209.72	1539.19	1595.56
	36"(914mm)	WURT-2436- S N43	573.99	615.49	747.51	860.53	902.03	1034.05	1274.01	1336.50	1692.07	1754.56
	42"(1067mm)	WURT-2442- S N43	632.43	677.95	823.65	937.09	982.61	1128.31	1394.67	1463.28	1844.95	1913.56
	48"(1219mm)	WURT-2448- S N43	690.87	740.41	899.79	1013.65	1063.19	1222.57	1515.33	1590.06	1997.83	2072.56
	54"(1372mm)	WURT-2454- S N43	749.31	802.87	975.93	1090.21	1143.77	1316.83	1635.99	1716.84	2150.71	2231.56
60"(1524mm)	WURT-2460- S N43	807.75	865.33	1052.07	1166.77	1224.35	1411.09	1756.65	1843.62	2303.59	2390.56	
24"(610mm)/30"(762mm)	24"(610mm)	WURT-3024- S N45	\$490.57	\$524.03	\$ 628.69	\$ 740.87	\$ 774.33	\$ 878.99	\$ 1066.15	\$ 1116.40	\$ 1419.77	\$ 1470.02
	30"(762mm)	WURT-3030- S N45	549.01	586.49	704.83	817.43	854.91	973.25	1186.81	1243.18	1572.65	1629.02
	36"(914mm)	WURT-3036- S N45	607.45	648.95	780.97	893.99	935.49	1067.51	1307.47	1369.96	1725.53	1788.02
	42"(1067mm)	WURT-3042- S N45	665.89	711.41	857.11	970.55	1016.07	1161.77	1428.13	1496.74	1878.41	1947.02
	48"(1219mm)	WURT-3048- S N45	724.33	773.87	933.25	1047.11	1096.65	1256.03	1548.79	1623.52	2031.29	2106.02
	54"(1372mm)	WURT-3054- S N45	782.77	836.33	1009.39	1123.67	1177.23	1350.29	1669.45	1750.30	2184.17	2265.02
60"(1524mm)	WURT-3060- S N45	841.21	898.79	1085.53	1200.23	1257.81	1444.55	1790.11	1877.08	2337.05	2424.02	
30"(762mm)/24"(610mm)	24"(610mm)	WURT-3024- S N54	\$490.57	\$524.03	\$ 628.69	\$ 740.87	\$ 774.33	\$ 878.99	\$ 1066.15	\$ 1116.40	\$ 1419.77	\$ 1470.02
	30"(762mm)	WURT-3030- S N54	549.01	586.49	704.83	817.43	854.91	973.25	1186.81	1243.18	1572.65	1629.02
	36"(914mm)	WURT-3036- S N54	607.45	648.95	780.97	893.99	935.49	1067.51	1307.47	1369.96	1725.53	1788.02
	42"(1067mm)	WURT-3042- S N54	665.89	711.41	857.11	970.55	1016.07	1161.77	1428.13	1496.74	1878.41	1947.02
	48"(1219mm)	WURT-3048- S N54	724.33	773.87	933.25	1047.11	1096.65	1256.03	1548.79	1623.52	2031.29	2106.02
	54"(1372mm)	WURT-3054- S N54	782.77	836.33	1009.39	1123.67	1177.23	1350.29	1669.45	1750.30	2184.17	2265.02
60"(1524mm)	WURT-3060- S N54	841.21	898.79	1085.53	1200.23	1257.81	1444.55	1790.11	1877.08	2337.05	2424.02	

Adaptable Worksurfaces — Rectangular

Swell/Inverse Swell

Swell

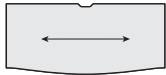

WURS

Inverse Swell

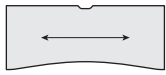

WURW
Class CA

Unique Specifications

- Suggested pedestal style is mobile.
- Belong Hatch cutout only available on Swell work surface.

To Order, Specify:

1) Product number, including:

1 Surface Option:

- L** Laminate
- W** Wood

2 Edge Option:

Laminate:

- J** Edgeband
- F** Knife

Wood:

- K** Edgeband
- U** Knife

3 Wireway/Cutout Option:

- A** Notched
- C** Without
- H** Belong Hatch

2) Laminate color or Wood finish color.

3) Edge trim color (laminite only).

Depth	Swell Depth	Width	Number	1	2	3	HPL Edgeband (J)			HPL Knife Edge (F)			Wood Edgeband (K)		Wood Knife Edge (U)			
							A	B	E	A	B	E	A	B	A	B		
Swell																		
18"(457mm)	21"(533mm)	24"(610mm)	WURS-1824-	S			\$ 442.18	\$473.21	\$571.48	\$686.35	\$717.38	\$815.65	\$904.93	\$956.63	\$1247.20	\$1298.90		
		30"(762mm)	WURS-1830-	S			487.86	522.13	630.66	745.73	780.00	888.53	996.01	1052.99	1362.38	1419.36		
		36"(914mm)	WURS-1836-	S			534.42	571.93	690.72	808.73	846.24	965.03	1087.09	1149.35	1482.38	1544.64		
		42"(1067mm)	WURS-1842-	S			580.98	621.73	750.78	871.73	912.48	1041.53	1178.17	1245.71	1602.38	1669.92		
		48"(1219mm)	WURS-1848-	S			627.54	671.53	810.84	934.73	978.72	1118.03	1269.25	1342.07	1722.38	1795.20		
		54"(1372mm)	WURS-1854-	S			674.10	721.33	870.90	997.73	1044.96	1194.53	1360.33	1438.43	1842.38	1920.48		
24"(610mm)	27"(686mm)	60"(1524mm)	WURS-1860-	S			720.66	771.13	930.96	1060.73	1111.20	1271.03	1451.41	1534.79	1962.38	2045.76		
		24"(610mm)	WURS-2424-	S			\$ 457.68	\$488.71	\$586.98	\$708.67	\$739.70	\$837.97	\$935.99	\$987.69	\$1286.81	\$1338.51		
		30"(762mm)	WURS-2430-	S			503.36	537.63	646.16	768.05	802.32	910.85	1032.29	1089.27	1407.21	1464.19		
		36"(914mm)	WURS-2436-	S			549.92	587.43	706.22	831.05	868.56	987.35	1128.59	1190.85	1532.43	1594.69		
		42"(1067mm)	WURS-2442-	S			596.48	637.23	766.28	894.05	934.80	1063.85	1224.89	1292.43	1657.65	1725.19		
		48"(1219mm)	WURS-2448-	S			643.04	687.03	826.34	957.05	1001.04	1140.35	1321.19	1394.01	1782.87	1855.69		
30"(762mm)	33"(838mm)	54"(1372mm)	WURS-2454-	S			689.60	736.83	886.40	1020.05	1067.28	1216.85	1417.49	1495.59	1908.09	1986.19		
		60"(1524mm)	WURS-2460-	S			736.16	786.63	946.46	1083.05	1133.52	1293.35	1513.79	1597.17	2033.31	2116.69		
		24"(610mm)	WURS-3024-	S			\$599.02	\$630.05	\$728.32	\$894.24	\$925.27	\$1023.54	\$1228.99	\$1280.69	\$1656.61	\$1708.31		
		30"(762mm)	WURS-3030-	S			644.70	678.97	787.50	953.62	987.89	1096.42	1330.27	1387.25	1781.99	1838.97		
		36"(914mm)	WURS-3036-	S			691.26	728.77	847.56	1016.62	1054.13	1172.92	1431.55	1493.81	1912.19	1974.45		
		42"(1067mm)	WURS-3042-	S			737.82	778.57	907.62	1079.62	1120.37	1249.42	1532.83	1600.37	2042.39	2109.93		
48"(1219mm)	54"(1372mm)	48"(1219mm)	WURS-3048-	S			784.38	828.37	967.68	1142.62	1186.61	1325.92	1634.11	1706.93	2172.59	2245.41		
		54"(1372mm)	WURS-3054-	S			830.94	878.17	1027.74	1205.62	1252.85	1402.42	1735.39	1813.49	2302.79	2380.89		
		60"(1524mm)	WURS-3060-	S			877.50	927.97	1087.80	1268.62	1319.09	1478.92	1836.67	1920.05	2432.99	2516.37		
		Inverse Swell																
		18"(457mm)	15"(381mm)	24"(610mm)	WURW-1824-	S			\$ 423.10	\$452.78	\$546.84	\$656.78	\$686.46	\$780.52	\$947.68	\$997.15	\$1275.22	\$1324.69
				30"(762mm)	WURW-1830-	S			466.68	499.30	603.26	713.56	746.18	850.14	1034.80	1089.19	1385.39	1439.78
36"(914mm)	WURW-1836-			S			511.08	546.64	660.50	773.80	809.36	923.22	1121.92	1181.23	1500.17	1559.48		
42"(1067mm)	WURW-1842-			S			555.48	593.98	717.74	834.04	872.54	996.30	1209.04	1273.27	1614.95	1679.18		
48"(1219mm)	WURW-1848-			S			599.88	641.32	774.98	894.28	935.72	1069.38	1296.16	1365.31	1729.73	1798.88		
54"(1372mm)	WURW-1854-			S			644.28	688.66	832.22	954.52	998.90	1142.46	1383.28	1457.35	1844.51	1918.58		
24"(610mm)	21"(533mm)	60"(1524mm)	WURW-1860-	S			688.68	736.00	889.46	1014.76	1062.08	1215.54	1470.40	1549.39	1959.29	2038.28		
		24"(610mm)	WURW-2424-	S			\$ 437.94	\$467.62	\$561.68	\$678.13	\$707.81	\$801.87	\$977.39	\$1026.86	\$1313.08	\$1362.55		
		30"(762mm)	WURW-2430-	S			481.52	514.14	618.10	734.91	767.53	871.49	1069.49	1123.88	1428.23	1482.62		
		36"(914mm)	WURW-2436-	S			525.92	561.48	675.34	795.15	830.71	944.57	1161.59	1220.90	1547.99	1607.30		
		42"(1067mm)	WURW-2442-	S			570.32	608.82	732.58	855.39	893.89	1017.65	1253.69	1317.92	1667.75	1731.98		
		48"(1219mm)	WURW-2448-	S			614.72	656.16	789.82	915.63	957.07	1090.73	1345.79	1414.94	1787.51	1856.66		
30"(762mm)	27"(686mm)	54"(1372mm)	WURW-2454-	S			659.12	703.50	847.06	975.87	1020.25	1163.81	1437.89	1511.96	1907.27	1981.34		
		60"(1524mm)	WURW-2460-	S			703.52	750.84	904.30	1036.11	1083.43	1236.89	1529.99	1608.98	2027.03	2106.02		
		24"(610mm)	WURW-3024-	S			\$ 573.19	\$602.87	\$696.93	\$855.73	\$885.41	\$979.47	\$1257.78	\$1307.25	\$1666.97	\$1716.44		
		30"(762mm)	WURW-3030-	S			616.77	649.39	753.35	912.51	945.13	1049.09	1354.80	1409.19	1787.04	1841.43		
		36"(914mm)	WURW-3036-	S			661.17	696.73	810.59	972.75	1008.31	1122.17	1451.82	1511.33	1911.72	1971.03		
		42"(1067mm)	WURW-3042-	S			705.57	744.07	867.83	1032.99	1071.49	1195.25	1548.84	1613.07	2036.40	2100.63		
48"(1219mm)	54"(1372mm)	48"(1219mm)	WURW-3048-	S			749.97	791.41	925.07	1093.23	1134.67	1268.33	1645.86	1715.01	2161.08	2230.23		
		54"(1372mm)	WURW-3054-	S			794.37	838.75	982.31	1153.47	1197.85	1341.41	1742.88	1816.95	2285.76	2359.83		
		60"(1524mm)	WURW-3060-	S			838.77	886.09	1039.55	1213.71	1261.03	1414.49	1839.90	1918.89	2410.44	2489.43		

Adaptable Worksurfaces — Rectangular

Wedge/Sharp Wedge

Wedge

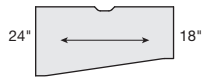
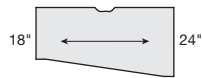
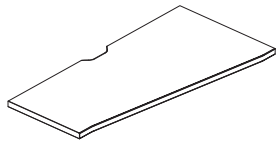

WURE-N34
WURE-N43

Sharp Wedge

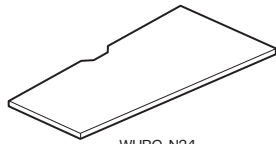

Class CA

Unique Specifications

- Suggested pedestal style is mobile.

To Order, Specify:

1) Product number, including:

1 Surface Option:

- L** Laminate
- W** Wood

2 Edge Option:

Laminate:

- J** Edgeband
- F** Knife

Wood:

- K** Edgeband
- U** Knife

3 Wireway/Cutout Option:

- A** Notched
- C** Without
- H** Belong Hatch

2) Laminate color or Wood finish color.

3) Edge trim color (laminite only).

Left/Right Depth	Width	Number 1 2 3	HPL Edgeband (J)			HPL Knife Edge (F)			Wood Edgeband (K)		Wood Knife Edge (U)	
			A	B	E	A	B	E	A	B	A	B
Wedge												
24"(610mm)/18"(457mm)	24"(610mm)	WURE-2424- S N43	\$ 658.82	\$ 693.82	\$ 798.37	\$ 909.80	\$ 944.80	\$ 1049.35	\$ 1216.42	\$ 1243.08	\$ 1550.37	\$ 1577.03
	30"(762mm)	WURE-2430- S N43	714.86	753.82	870.43	987.86	1026.82	1143.43	1336.30	1377.90	1706.37	1747.97
	36"(914mm)	WURE-2436- S N43	770.90	813.82	942.49	1065.92	1108.84	1237.51	1456.18	1512.72	1862.37	1918.91
	42"(1067mm)	WURE-2442- S N43	826.94	873.82	1014.55	1143.98	1190.86	1331.59	1576.06	1647.54	2018.37	2089.85
	48"(1219mm)	WURE-2448- S N43	882.98	933.82	1086.61	1222.04	1272.88	1425.67	1695.94	1782.36	2174.37	2260.79
	54"(1372mm)	WURE-2454- S N43	939.02	993.82	1158.67	1300.10	1354.90	1519.75	1815.82	1917.18	2330.37	2431.73
	60"(1524mm)	WURE-2460- S N43	995.06	1053.82	1230.73	1378.16	1436.92	1613.83	1935.70	2052.00	2486.37	2602.67
	66"(1676mm)	WURE-2466- S N43	1051.10	1113.82	1302.79	1456.22	1518.94	1707.91	2055.58	2186.82	2642.37	2773.61
	72"(1829mm)	WURE-2472- S N43	1107.14	1173.82	1374.85	1534.28	1600.96	1801.99	2175.46	2321.64	2798.37	2944.55
	78"(1981mm)	WURE-2478- S N43	1163.18	1233.82	1446.91	1612.34	1682.98	1896.07	2295.34	2456.46	2954.37	3115.49
	84"(2134mm)	WURE-2484- S N43	1219.22	1293.82	1518.97	1690.40	1765.00	1990.15	2415.22	2591.28	3110.37	3286.43
	90"(2286mm)	WURE-2490- S N43	1275.26	1353.82	1591.03	1768.46	1847.02	2084.23	2535.10	2726.10	3266.37	3457.37
	96"(2438mm)	WURE-2496- S N43	1331.30	1413.82	1663.09	1846.52	1929.04	2178.31	2654.98	2860.92	3422.37	3628.31
	102"(2591mm)	WURE-24A2- S N43	1387.34	1473.82	1735.15	1924.58	2011.06	2272.39	2774.86	2995.74	3578.37	3799.25
	108"(2743mm)	WURE-24A8- S N43	1443.38	1533.82	1807.21	2002.64	2093.08	2366.47	2894.74	3130.56	3734.37	3970.19
	114"(2896mm)	WURE-24B4- S N43	1480.74	1573.82	1855.25	2054.68	2147.76	2429.19	2974.66	3220.44	3838.37	4084.15
	120"(3048mm)	WURE-24C0- S N43	1555.46	1653.82	1951.33	2158.76	2257.12	2554.63	3134.50	3400.20	4046.37	4312.07

Adaptable Worksurfaces — Rectangular

Wedge/Sharp Wedge

Left/Right Depth	Width	Number ①② ③	HPL Edgeband (J)			HPL Knife Edge (F)			Wood Edgeband (K)		Wood Knife Edge (U)	
			A	B	E	A	B	E	A	B	A	B
18"(457mm)/24"(610mm)	24"(610mm)	WURE-2424- S N34	\$ 658.82	\$ 693.82	\$ 798.37	\$ 909.80	\$ 944.80	\$ 1049.35	\$ 1216.42	\$ 1243.08	\$ 1550.37	\$ 1577.03
	30"(762mm)	WURE-2430- S N34	714.86	753.82	870.43	987.86	1026.82	1143.43	1336.30	1377.90	1706.37	1747.97
	36"(914mm)	WURE-2436- S N34	770.90	813.82	942.49	1065.92	1108.84	1237.51	1456.18	1512.72	1862.37	1918.91
	42"(1067mm)	WURE-2442- S N34	826.94	873.82	1014.55	1143.98	1190.86	1331.59	1576.06	1647.54	2018.37	2089.85
	48"(1219mm)	WURE-2448- S N34	882.98	933.82	1086.61	1222.04	1272.88	1425.67	1695.94	1782.36	2174.37	2260.79
	54"(1372mm)	WURE-2454- S N34	939.02	993.82	1158.67	1300.10	1354.90	1519.75	1815.82	1917.18	2330.37	2431.73
	60"(1524mm)	WURE-2460- S N34	995.06	1053.82	1230.73	1378.16	1436.92	1613.83	1935.70	2052.00	2486.37	2602.67
	66"(1676mm)	WURE-2466- S N34	1051.10	1113.82	1302.79	1456.22	1518.94	1707.91	2055.58	2186.82	2642.37	2773.61
	72"(1829mm)	WURE-2472- S N34	1107.14	1173.82	1374.85	1534.28	1600.96	1801.99	2175.46	2321.64	2798.37	2944.55
	78"(1981mm)	WURE-2478- S N34	1163.18	1233.82	1446.91	1612.34	1682.98	1896.07	2295.34	2456.46	2954.37	3115.49
	84"(2134mm)	WURE-2484- S N34	1219.22	1293.82	1518.97	1690.40	1765.00	1990.15	2415.22	2591.28	3110.37	3286.43
	90"(2286mm)	WURE-2490- S N34	1275.26	1353.82	1591.03	1768.46	1847.02	2084.23	2535.10	2726.10	3266.37	3457.37
	96"(2438mm)	WURE-2496- S N34	1331.30	1413.82	1663.09	1846.52	1929.04	2178.31	2654.98	2860.92	3422.37	3628.31
	102"(2591mm)	WURE-24A2- S N34	1387.34	1473.82	1735.15	1924.58	2011.06	2272.39	2774.86	2995.74	3578.37	3799.25
30"(762mm)/24"(610mm)	24"(610mm)	WURE-3024- S N54	\$ 675.46	\$ 710.46	\$ 815.01	\$ 926.44	\$ 961.44	\$ 1065.99	\$ 1233.06	\$ 1259.72	\$ 1567.01	\$ 1593.67
	30"(762mm)	WURE-3030- S N54	731.50	770.46	887.07	1004.50	1043.46	1160.07	1352.94	1394.54	1723.01	1764.61
	36"(914mm)	WURE-3036- S N54	787.54	830.46	959.13	1082.56	1125.48	1254.15	1472.82	1529.36	1879.01	1935.55
	42"(1067mm)	WURE-3042- S N54	843.58	890.46	1031.19	1160.62	1207.50	1348.23	1592.70	1664.18	2035.01	2106.49
	48"(1219mm)	WURE-3048- S N54	899.62	950.46	1103.25	1238.68	1289.52	1442.31	1712.58	1799.00	2191.01	2277.43
	54"(1372mm)	WURE-3054- S N54	955.66	1010.46	1175.31	1316.74	1371.54	1536.39	1832.46	1933.82	2347.01	2448.37
	60"(1524mm)	WURE-3060- S N54	1011.70	1070.46	1247.37	1394.80	1453.56	1630.47	1952.34	2068.64	2503.01	2619.31
	66"(1676mm)	WURE-3066- S N54	1067.74	1130.46	1319.43	1472.86	1535.58	1724.55	2072.22	2203.46	2659.01	2790.25
	72"(1829mm)	WURE-3072- S N54	1123.78	1190.46	1391.49	1550.92	1617.60	1818.63	2192.10	2338.28	2815.01	2961.19
	78"(1981mm)	WURE-3078- S N54	1179.82	1250.46	1463.55	1628.98	1699.62	1912.71	2311.98	2473.10	2971.01	3132.13
	84"(2134mm)	WURE-3084- S N54	1235.86	1310.46	1535.61	1707.04	1781.64	2006.79	2431.86	2607.92	3127.01	3303.07
	90"(2286mm)	WURE-3090- S N54	1291.90	1370.46	1607.67	1785.10	1863.66	2100.87	2551.74	2742.74	3283.01	3474.01
	96"(2438mm)	WURE-3096- S N54	1347.94	1430.46	1679.73	1863.16	1945.68	2194.95	2671.62	2877.56	3439.01	3644.95
	102"(2591mm)	WURE-30A2- S N54	1403.98	1490.46	1751.79	1941.22	2027.70	2289.03	2791.50	3012.38	3595.01	3815.89
24"(610mm)/30"(762mm)	24"(610mm)	WURE-3024- S N45	\$ 675.46	\$ 710.46	\$ 815.01	\$ 926.44	\$ 961.44	\$ 1065.99	\$ 1233.06	\$ 1259.72	\$ 1567.01	\$ 1593.67
	30"(762mm)	WURE-3030- S N45	731.50	770.46	887.07	1004.50	1043.46	1160.07	1352.94	1394.54	1723.01	1764.61
	36"(914mm)	WURE-3036- S N45	787.54	830.46	959.13	1082.56	1125.48	1254.15	1472.82	1529.36	1879.01	1935.55
	42"(1067mm)	WURE-3042- S N45	843.58	890.46	1031.19	1160.62	1207.50	1348.23	1592.70	1664.18	2035.01	2106.49
	48"(1219mm)	WURE-3048- S N45	899.62	950.46	1103.25	1238.68	1289.52	1442.31	1712.58	1799.00	2191.01	2277.43
	54"(1372mm)	WURE-3054- S N45	955.66	1010.46	1175.31	1316.74	1371.54	1536.39	1832.46	1933.82	2347.01	2448.37
	60"(1524mm)	WURE-3060- S N45	1011.70	1070.46	1247.37	1394.80	1453.56	1630.47	1952.34	2068.64	2503.01	2619.31
	66"(1676mm)	WURE-3066- S N45	1067.74	1130.46	1319.43	1472.86	1535.58	1724.55	2072.22	2203.46	2659.01	2790.25
	72"(1829mm)	WURE-3072- S N45	1123.78	1190.46	1391.49	1550.92	1617.60	1818.63	2192.10	2338.28	2815.01	2961.19
	78"(1981mm)	WURE-3078- S N45	1179.82	1250.46	1463.55	1628.98	1699.62	1912.71	2311.98	2473.10	2971.01	3132.13
	84"(2134mm)	WURE-3084- S N45	1235.86	1310.46	1535.61	1707.04	1781.64	2006.79	2431.86	2607.92	3127.01	3303.07
	90"(2286mm)	WURE-3090- S N45	1291.90	1370.46	1607.67	1785.10	1863.66	2100.87	2551.74	2742.74	3283.01	3474.01
	96"(2438mm)	WURE-3096- S N45	1347.94	1430.46	1679.73	1863.16	1945.68	2194.95	2671.62	2877.56	3439.01	3644.95
	102"(2591mm)	WURE-30A2- S N45	1403.98	1490.46	1751.79	1941.22	2027.70	2289.03	2791.50	3012.38	3595.01	3815.89
108"(2743mm)	WURE-30A8- S N45	1460.02	1550.46	1823.85	2019.28	2109.72	2383.11	2911.38	3147.20	3751.01	3986.83	
114"(2896mm)	WURE-30B4- S N45	1497.38	1590.46	1871.89	2071.32	2164.40	2445.83	2991.30	3237.08	3855.01	4100.79	
120"(3048mm)	WURE-30C0- S N45	1572.10	1670.46	1967.97	2175.40	2273.76	2571.27	3151.14	3416.84	4063.01	4328.71	

Adaptable Worksurfaces — Rectangular

Wedge/Sharp Wedge

Left/Right Depth	Width	Number ① ② ③	HPL Edgeband (J)			HPL Knife Edge (F)			Wood Edgeband (K)		Wood Knife Edge (U)			
			A	B	E	A	B	E	A	B	A	B		
Sharp Wedge														
24"(610mm)/18"(457mm)	24"(610mm)	WURG-2424-	S	N43	\$636.58	\$ 673.40	\$ 783.06	\$ 890.25	\$ 927.07	\$1036.73	\$1223.24	\$ 1328.70	\$ 1570.23	\$ 1675.69
	30"(762mm)	WURG-2430-	S	N43	699.22	736.15	860.20	973.97	1010.90	1134.95	1351.83	1480.15	1737.16	1865.48
	36"(914mm)	WURG-2436-	S	N43	761.86	798.90	937.34	1057.69	1094.73	1233.17	1480.42	1631.60	1904.09	2055.27
	42"(1067mm)	WURG-2442-	S	N43	824.50	861.65	1014.48	1141.41	1178.56	1331.39	1609.01	1783.05	2071.02	2245.06
	48"(1219mm)	WURG-2448-	S	N43	887.14	924.40	1091.62	1225.13	1262.39	1429.61	1737.60	1934.50	2237.95	2434.85
	54"(1372mm)	WURG-2454-	S	N43	949.78	987.15	1168.76	1308.85	1346.22	1527.83	1866.19	2085.95	2404.88	2624.64
	60"(1524mm)	WURG-2460-	S	N43	1012.42	1049.90	1245.90	1392.57	1430.05	1626.05	1994.78	2237.40	2571.81	2814.43
18"(457mm)/24"(610mm)	24"(610mm)	WURG-2424-	S	N34	\$636.58	\$ 673.40	\$ 783.06	\$ 890.25	\$ 927.07	\$1036.73	\$1223.24	\$ 1328.70	\$ 1570.23	\$ 1675.69
	30"(762mm)	WURG-2430-	S	N34	699.22	736.15	860.20	973.97	1010.90	1134.95	1351.83	1480.15	1737.16	1865.48
	36"(914mm)	WURG-2436-	S	N34	761.86	798.90	937.34	1057.69	1094.73	1233.17	1480.42	1631.60	1904.09	2055.27
	42"(1067mm)	WURG-2442-	S	N34	824.50	861.65	1014.48	1141.41	1178.56	1331.39	1609.01	1783.05	2071.02	2245.06
	48"(1219mm)	WURG-2448-	S	N34	887.14	924.40	1091.62	1225.13	1262.39	1429.61	1737.60	1934.50	2237.95	2434.85
	54"(1372mm)	WURG-2454-	S	N34	949.78	987.15	1168.76	1308.85	1346.22	1527.83	1866.19	2085.95	2404.88	2624.64
	60"(1524mm)	WURG-2460-	S	N34	1012.42	1049.90	1245.90	1392.57	1430.05	1626.05	1994.78	2237.40	2571.81	2814.43
30"(762mm)/24"(610mm)	24"(610mm)	WURG-3024-	S	N54	\$645.78	\$ 683.07	\$ 795.72	\$ 907.49	\$ 944.78	\$1057.43	\$1247.84	\$ 1357.68	\$ 1594.83	\$ 1704.67
	30"(762mm)	WURG-3030-	S	N54	708.42	745.82	872.86	991.21	1028.61	1155.65	1376.43	1509.13	1761.76	1894.46
	36"(914mm)	WURG-3036-	S	N54	771.06	808.57	950.00	1074.93	1112.44	1253.87	1505.02	1660.58	1928.69	2084.25
	42"(1067mm)	WURG-3042-	S	N54	833.70	871.32	1027.14	1158.65	1196.27	1352.09	1633.61	1812.03	2095.62	2274.04
	48"(1219mm)	WURG-3048-	S	N54	896.34	934.07	1104.28	1242.37	1280.10	1450.31	1762.20	1963.48	2262.55	2463.83
	54"(1372mm)	WURG-3054-	S	N54	958.98	996.82	1181.42	1326.09	1363.93	1548.53	1890.79	2114.93	2429.48	2653.62
	60"(1524mm)	WURG-3060-	S	N54	1021.62	1059.57	1258.56	1409.81	1447.76	1646.75	2019.38	2266.38	2596.41	2843.41
24"(610mm)/30"(762mm)	24"(610mm)	WURG-3024-	S	N45	\$645.78	\$ 683.07	\$ 795.72	\$ 907.49	\$ 944.78	\$1057.43	\$1247.84	\$ 1357.68	\$ 1594.83	\$ 1704.67
	30"(762mm)	WURG-3030-	S	N45	708.42	745.82	872.86	991.21	1028.61	1155.65	1376.43	1509.13	1761.76	1894.46
	36"(914mm)	WURG-3036-	S	N45	771.06	808.57	950.00	1074.93	1112.44	1253.87	1505.02	1660.58	1928.69	2084.25
	42"(1067mm)	WURG-3042-	S	N45	833.70	871.32	1027.14	1158.65	1196.27	1352.09	1633.61	1812.03	2095.62	2274.04
	48"(1219mm)	WURG-3048-	S	N45	896.34	934.07	1104.28	1242.37	1280.10	1450.31	1762.20	1963.48	2262.55	2463.83
	54"(1372mm)	WURG-3054-	S	N45	958.98	996.82	1181.42	1326.09	1363.93	1548.53	1890.79	2114.93	2429.48	2653.62
	60"(1524mm)	WURG-3060-	S	N45	1021.62	1059.57	1258.56	1409.81	1447.76	1646.75	2019.38	2266.38	2596.41	2843.41

Adaptable Worksurfaces — Rectangular

Rectangular Radius End



(Right-hand orientation)



(Left-hand orientation)

WURR
Class CA

Unique Specifications

- Separately specified floor support required on radius end:
–Side/corner bracket with worksurface support leg or column.
- Worksurfaces less than 42”(1067mm)W, suggested pedestal style is mobile.
- Laminate worksurface will have 3mm edgeband or knife edge on user edge and side and 1mm edgeband on remaining side and back.

To Order, Specify:

1) Product number, including:

1 Surface Option:

- L** Laminate
- W** Wood

2 Edge Option:

Laminate:

- J** Edgeband
- F** Knife

Wood:

- K** Edgeband
- U** Knife

3 Wireway Option:

- A** Notched
- C** Without

4 Orientation (as seated):

- R** Right-hand
- L** Left-hand

2) Laminate color or Wood finish color.

3) Edge trim color (laminite only).

Depth	Width	Number 1 2 3 4	HPL Edgeband (J)			HPL Knife Edge (F)			Wood Edgeband (K)		Wood Knife Edge (U)	
			A	B	E	A	B	E	A	B	A	B
18”(457mm)	24”(610mm)	WURR-1824- S	\$494.03	\$ 523.71	\$ 613.61	\$ 724.44	\$ 754.12	\$ 844.02	\$1005.40	\$ 1049.94	\$ 1330.56	\$ 1375.10
	30”(762mm)	WURR-1830- S	551.53	585.05	686.29	795.14	828.66	929.90	1123.36	1172.82	1500.52	1549.98
	36”(914mm)	WURR-1836- S	609.85	647.21	759.79	869.30	906.66	1019.24	1241.32	1295.70	1680.88	1735.26
	42”(1067mm)	WURR-1842- S	668.17	709.37	833.29	943.46	984.66	1108.58	1359.28	1418.58	1861.24	1920.54
	48”(1219mm)	WURR-1848- S	726.49	771.53	906.79	1017.62	1062.66	1197.92	1477.24	1541.46	2041.60	2105.82
	54”(1372mm)	WURR-1854- S	784.81	833.69	980.29	1091.78	1140.66	1287.26	1595.20	1664.34	2221.96	2291.10
60”(1524mm)	WURR-1860- S	843.13	895.85	1053.79	1165.94	1218.66	1376.60	1713.16	1787.22	2402.32	2476.38	
24”(610mm)	24”(610mm)	WURR-2424- S	\$505.60	\$ 535.28	\$ 625.18	\$ 739.28	\$ 768.96	\$ 858.86	\$ 1018.61	\$ 1063.15	\$ 1351.94	\$ 1396.48
	30”(762mm)	WURR-2430- S	563.10	596.62	697.86	809.98	843.50	944.74	1139.39	1188.85	1524.72	1574.18
	36”(914mm)	WURR-2436- S	621.42	658.78	771.36	884.14	921.50	1034.08	1260.17	1314.55	1707.90	1762.28
	42”(1067mm)	WURR-2442- S	679.74	720.94	844.86	958.30	999.50	1123.42	1380.95	1440.25	1891.08	1950.38
	48”(1219mm)	WURR-2448- S	738.06	783.10	918.36	1032.46	1077.50	1212.76	1501.73	1565.95	2074.26	2138.48
	54”(1372mm)	WURR-2454- S	796.38	845.26	991.86	1106.62	1155.50	1302.10	1622.51	1691.65	2257.44	2326.58
60”(1524mm)	WURR-2460- S	854.70	907.42	1065.36	1180.78	1233.50	1391.44	1743.29	1817.35	2440.62	2514.68	
30”(762mm)	24”(610mm)	WURR-3024- S	\$ 660.61	\$ 690.29	\$ 780.19	\$ 954.53	\$ 984.21	\$ 1074.11	\$ 1233.06	\$ 1277.60	\$ 1667.64	\$ 1712.18
	30”(762mm)	WURR-3030- S	718.11	751.63	852.87	1025.23	1058.75	1159.99	1356.84	1406.30	1843.42	1892.88
	36”(914mm)	WURR-3036- S	776.43	813.79	926.37	1099.39	1136.75	1249.33	1480.62	1535.00	2029.60	2083.98
	42”(1067mm)	WURR-3042- S	834.75	875.95	999.87	1173.55	1214.75	1338.67	1604.40	1663.70	2215.78	2275.08
	48”(1219mm)	WURR-3048- S	893.07	938.11	1073.37	1247.71	1292.75	1428.01	1728.18	1792.40	2401.96	2466.18
	54”(1372mm)	WURR-3054- S	951.39	1000.27	1146.87	1321.87	1370.75	1517.35	1851.96	1921.10	2588.14	2657.28
60”(1524mm)	WURR-3060- S	1009.71	1062.43	1220.37	1396.03	1448.75	1606.69	1975.74	2049.80	2774.32	2848.38	

Adaptable Worksurfaces — Corner

General Specifications



WUCB-R45
WUCB-L54
Bent



WUCZ-N44
Corner, 120° Wrap-Around



WURM
120° Rectangular Radius End



WURL
120° Rectangular Square End

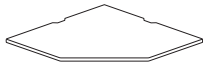

WUCA-L
Corner, 90° Straight Front



WUCR
Corner, 90° Wrap-Around



WUCT-N34
WUCT-N43
Transitional

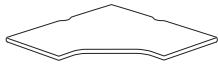

WUCN
Corner, 90° Notched



WUCH-N34
WUCH-N43
Transitional



WUCX-R34
WUCX-L43
Corner, 90° Wrap-Around
Transitional Extended

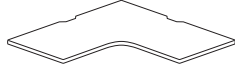

WUCQ-N44
90° Merger



WUCU
Corner, 90° Angled



WUCF-L45
WUCF-L54
Corner, 90° Angled-
Transitional



WUCE-R44
WUCE-L44
Corner, 90° Wrap-Around
Extended



WUCP-R44
WUCP-L44
Corner, 90° Notched
Extended

Common Features

- Includes worksurface and tie plate.
- Available in high-pressure laminate (HPL) or wood veneer. Grade E laminate available on rectangular worksurfaces only.
- Laminate edge option:
 - (J) 3mm edgeband on user side with 1mm edgeband on sides and back.
 - (F) Knife edge on user side and 1mm edgeband on sides and back.
- Wood veneer edge option:
 - (K) 3mm edgeband on user side with 1mm edgeband on sides and back.
 - (U) Knife edge on user side and 1mm edgeband on sides and back.
- Worksurfaces predrilled to accept most support options.
- Optional wireway:
 - Wireway will be color-matched to solid side/back edge trim. Wood veneer or patterned/wood grain laminate will have a Charcoal wireway.
 - Refer to Specification Guide for wireway details.
- Optional Belong Hatch cutout:
 - Laminate tops only with one cutout.
 - Available on worksurfaces 30"(762mm)D and widths of 54"(1372mm) and 60"(1524mm).
 - Requires separately specified Belong Hatch.
 - Refer to Specification Guide for cutout details.
- **Installed worksurfaces without wireway will not allow clearance for power plug.**
- Depth, width and length shown in nominal dimensions.

Specification Tips

- **Corner bracket is required and must be separately specified.**
- **Worksurface support specific to product line and worksurface edge guidelines; must be separately specified.**
- Knife edge requires use of worksurface supports for that application; worksurface support panel and/or side bracket for use with knife edge.
- Intermediate support is required for unsupported worksurface span greater than 60"(1524mm).
- Not intended for use on Height Adjustable Tables.

Note: Separately specified worksurface reinforcement bar provides additional support for worksurfaces with 60"(1524mm) spans that are heavily loaded and not otherwise supported by mid-span cantilevers, worksurface support panels, columns, legs or attached lower storage.

Adaptable Worksurfaces — Corner Bent

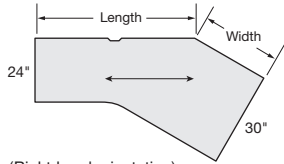

(Right-hand orientation)

WUCB-R45

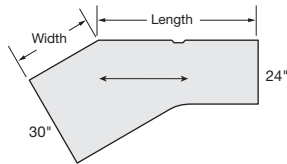

(Left-hand orientation)

WUCB-L54

Class CA

To Order, Specify:

1) Product number, including:

1 Surface Option:

L Laminate

W Wood

2 Edge Option:

Laminate:

J Edgeband

F Knife

Wood:

K Edgeband

U Knife

3 Wireway/Cutout Option:

A Notched

C Without

2) Laminate color or Wood finish color.

3) Edge trim color (laminite only).

Left/Right Depth	Width	Length	Number ①②③	HPL Edgeband (J)		HPL Knife Edge (F)		Wood Edgeband (K)		Wood Knife Edge (U)	
				A	B	A	B	A	B	A	B
24"(610mm)/30"(762mm)	24"(610mm)	36"(914mm)	WUCB-2436-■ S ■ R45	\$1084.80	\$ 1162.54	\$ 1536.91	\$ 1614.65	\$ 1657.25	\$ 1779.15	\$ 2192.66	\$ 2314.56
		42"(1067mm)	WUCB-2442-■ S ■ R45	1223.04	1310.68	1720.03	1807.67	1805.21	1953.45	2391.19	2539.43
		48"(1219mm)	WUCB-2448-■ S ■ R45	1449.61	1547.15	1991.48	2089.02	2218.16	2392.74	2854.71	3029.29
		60"(1524mm)	WUCB-2460-■ S ■ R45	1637.76	1755.10	2269.39	2386.73	2602.41	2829.67	3340.10	3567.36
24"(610mm)/30"(762mm)	30"(762mm)	36"(914mm)	WUCB-3036-■ S ■ R45	\$1223.04	\$ 1310.68	\$ 1720.03	\$ 1807.67	\$ 1805.21	\$ 1953.45	\$ 2391.19	\$ 2539.43
		42"(1067mm)	WUCB-3042-■ S ■ R45	1361.28	1458.82	1903.15	2000.69	1953.17	2127.75	2589.72	2764.30
		48"(1219mm)	WUCB-3048-■ S ■ R45	1587.85	1695.29	2174.60	2282.04	2366.12	2567.04	3053.24	3254.16
		60"(1524mm)	WUCB-3060-■ S ■ R45	1776.00	1903.24	2452.51	2579.75	2750.37	3003.97	3538.63	3792.23
30"(762mm)/24"(610mm)	24"(610mm)	36"(914mm)	WUCB-2436-■ S ■ L54	\$1084.80	\$ 1162.54	\$ 1536.91	\$ 1614.65	\$ 1657.25	\$ 1779.15	\$ 2192.66	\$ 2314.56
		42"(1067mm)	WUCB-2442-■ S ■ L54	1223.04	1310.68	1720.03	1807.67	1805.21	1953.45	2391.19	2539.43
		48"(1219mm)	WUCB-2448-■ S ■ L54	1449.61	1547.15	1991.48	2089.02	2218.16	2392.74	2854.71	3029.29
		60"(1524mm)	WUCB-2460-■ S ■ L54	1637.76	1755.10	2269.39	2386.73	2602.41	2829.67	3340.10	3567.36
30"(762mm)/24"(610mm)	30"(762mm)	36"(914mm)	WUCB-3036-■ S ■ L54	\$1223.04	\$ 1310.68	\$ 1720.03	\$ 1807.67	\$ 1805.21	\$ 1953.45	\$ 2391.19	\$ 2539.43
		42"(1067mm)	WUCB-3042-■ S ■ L54	1361.28	1458.82	1903.15	2000.69	1953.17	2127.75	2589.72	2764.30
		48"(1219mm)	WUCB-3048-■ S ■ L54	1587.85	1695.29	2174.60	2282.04	2366.12	2567.04	3053.24	3254.16
		60"(1524mm)	WUCB-3060-■ S ■ L54	1776.00	1903.24	2452.51	2579.75	2750.37	3003.97	3538.63	3792.23

Adaptable Worksurfaces — Corner

120° Rectangular Radius and Square End

120° Rectangular Radius End

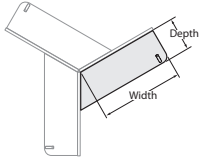
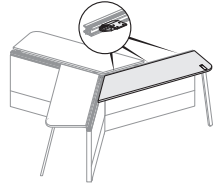

WURM

120° Rectangular Square End

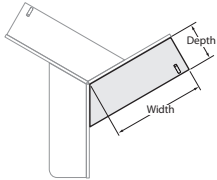
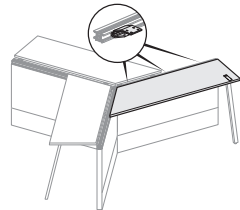

WURL
Class CA

Unique Specifications

- **Wireway not available.**
- Separately specified floor support required on radius/square end:
 - Connections Cantilever Worksurface Support Bracket with worksurface support leg or column; applicable to edgeband worksurface trim, only
 - Work Rail Top Trim Off-Modular Worksurface Support Bracket with worksurface support leg or column
- Panel Frame Heights: 26"(660mm) only
- Panel Frame Heights: 34"(864mm)-74"(1880mm)
- Standard Cantilever Worksurface Support Bracket with worksurface support leg or column; applicable to edgeband worksurface trim, only

To Order, Specify:

1) Product number, including:

1 Surface Option:

- L** Laminate
- W** Wood

2 Edge Option:

Laminate:

- J** Edgeband
- F** Knife

Wood:

- K** Edgeband
- U** Knife

3 Wireway/Cutout Option:

- C** Without
- H** Belong Hatch

4 Orientation (as seated):

- R** Right-hand
- L** Left-hand

2) Laminate color or Wood finish color.

3) Edge trim color (laminated only).

Note: Cantilever bracket cannot be used on radius end with knife edge worksurface trim.

Depth	Width	Number	①	②	③	④	HPL Edgeband (J)			HPL Knife Edge (F)			Wood Edgeband (K)		Wood Knife Edge (U)	
							A	B	E	A	B	E	A	B	A	B
Radius End																
24"(610mm)	36"(914mm)	WURM-2436-	S				\$ 986.17	\$1067.50	\$ 1316.55	\$1274.44	\$ 1355.77	\$1604.82	\$2043.62	\$ 2231.84	\$ 2667.18	\$2855.40
	42"(1067mm)	WURM-2442-	S				1023.79	1108.00	1374.77	1325.32	1409.53	1676.30	2129.88	2333.06	2763.04	2966.22
	48"(1219mm)	WURM-2448-	S				1061.41	1148.50	1432.99	1376.20	1463.29	1747.78	2216.14	2434.28	2858.90	3077.04
	54"(1372mm)	WURM-2454-	S				1099.03	1189.00	1491.21	1427.08	1517.05	1819.26	2302.40	2535.50	2954.76	3187.86
	60"(1524mm)	WURM-2460-	S				1136.65	1229.50	1549.43	1477.96	1570.81	1890.74	2388.66	2636.72	3050.62	3298.68
30"(762mm)	36"(914mm)	WURM-3036-	S				\$ 1043.47	\$ 1129.12	\$1404.75	\$1353.04	\$1438.69	\$ 1714.32	\$ 2173.76	\$2384.42	\$ 2812.92	\$3023.58
	42"(1067mm)	WURM-3042-	S				1090.00	1179.25	1477.03	1412.83	1502.08	1799.86	2281.09	2510.45	2929.85	3159.21
	48"(1219mm)	WURM-3048-	S				1136.53	1229.38	1549.31	1472.62	1565.47	1885.40	2388.42	2636.48	3046.78	3294.84
	54"(1372mm)	WURM-3054-	S				1183.06	1279.51	1621.59	1532.41	1628.86	1970.94	2495.75	2762.51	3163.71	3430.47
	60"(1524mm)	WURM-3060-	S				1229.59	1329.64	1693.87	1592.20	1692.25	2056.48	2603.08	2888.54	3280.64	3566.10
Square End																
24"(610mm)	36"(914mm)	WURL-2436-	S				\$ 986.17	\$1067.50	\$ 1316.55	\$1274.44	\$ 1355.77	\$1604.82	\$2043.62	\$ 2231.84	\$ 2667.18	\$2855.40
	42"(1067mm)	WURL-2442-	S				1023.79	1108.00	1374.77	1325.32	1409.53	1676.30	2129.88	2333.06	2763.04	2966.22
	48"(1219mm)	WURL-2448-	S				1061.41	1148.50	1432.99	1376.20	1463.29	1747.78	2216.14	2434.28	2858.90	3077.04
	54"(1372mm)	WURL-2454-	S				1099.03	1189.00	1491.21	1427.08	1517.05	1819.26	2302.40	2535.50	2954.76	3187.86
	60"(1524mm)	WURL-2460-	S				1136.65	1229.50	1549.43	1477.96	1570.81	1890.74	2388.66	2636.72	3050.62	3298.68
30"(762mm)	36"(914mm)	WURL-3036-	S				\$ 1043.47	\$ 1129.12	\$1404.75	\$1353.04	\$1438.69	\$ 1714.32	\$ 2173.76	\$2384.42	\$ 2812.92	\$3023.58
	42"(1067mm)	WURL-3042-	S				1090.00	1179.25	1477.03	1412.83	1502.08	1799.86	2281.09	2510.45	2929.85	3159.21
	48"(1219mm)	WURL-3048-	S				1136.53	1229.38	1549.31	1472.62	1565.47	1885.40	2388.42	2636.48	3046.78	3294.84
	54"(1372mm)	WURL-3054-	S				1183.06	1279.51	1621.59	1532.41	1628.86	1970.94	2495.75	2762.51	3163.71	3430.47
	60"(1524mm)	WURL-3060-	S				1229.59	1329.64	1693.87	1592.20	1692.25	2056.48	2603.08	2888.54	3280.64	3566.10

Adaptable Worksurfaces — Corner

Wrap Around Corner – 120°

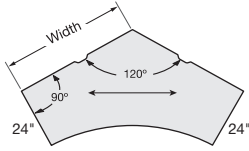
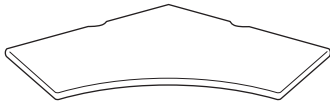

WUCZ-N44
Class CA

To Order, Specify:

1) Product number, including:

1 Surface Option:

- L** Laminate
- W** Wood

2 Edge Option:

Laminate:

- J** Edgeband
- F** Knife

Wood:

- K** Edgeband
- U** Knife

3 Wireway Option:

- A** Notched
- C** Without

2) Laminate color or Wood finish color.

3) Edge trim color (laminite only).

Depth	Width	Number	1 2 3	HPL Edgeband (J)		HPL Knife Edge (F)		Wood Edgeband (K)		Wood Knife Edge (U)	
				A	B	A	B	A	B	A	B
18"(457mm)	36"(914mm)	WUCZ-3636-	S N33	\$ 1605.64	\$ 1672.76	\$ 2011.99	\$ 2079.11	\$2264.26	\$ 2398.88	\$ 2768.72	\$2903.34
	42"(1067mm)	WUCZ-4242-	S N33	1747.18	1824.41	2197.18	2274.41	2480.71	2653.88	3040.49	3213.66
	48"(1219mm)	WUCZ-4848-	S N33	1888.72	1976.06	2382.37	2469.71	2697.16	2908.88	3312.26	3523.98
	54"(1372mm)	WUCZ-5454-	S N33	2030.26	2127.71	2567.56	2665.01	2913.61	3163.88	3584.03	3834.30
	60"(1524mm)	WUCZ-6060-	S N33	2171.80	2279.36	2752.75	2860.31	N/A	N/A	N/A	N/A
24"(610mm)	36"(914mm)	WUCZ-3636-	S N44	\$ 1739.11	\$ 1816.86	\$ 2145.46	\$ 2223.21	\$2398.54	\$ 2557.10	\$2903.00	\$ 3061.56
	42"(1067mm)	WUCZ-4242-	S N44	1880.65	1968.51	2330.65	2418.51	2614.99	2812.10	3174.77	3371.88
	48"(1219mm)	WUCZ-4848-	S N44	2022.19	2120.16	2515.84	2613.81	2831.44	3067.10	3446.54	3682.20
	54"(1372mm)	WUCZ-5454-	S N44	2163.73	2271.81	2701.03	2809.11	3047.89	3322.10	3718.31	3992.52
	60"(1524mm)	WUCZ-6060-	S N44	2305.27	2423.46	2886.22	3004.41	N/A	N/A	N/A	N/A
30"(762mm)	36"(914mm)	WUCZ-3636-	S N55	\$ 1872.58	\$1960.96	\$2278.93	\$ 2367.31	\$2532.82	\$ 2715.32	\$ 3037.28	\$ 3219.78
	42"(1067mm)	WUCZ-4242-	S N55	2014.12	2112.61	2464.12	2562.61	2749.27	2970.32	3309.05	3530.10
	48"(1219mm)	WUCZ-4848-	S N55	2155.66	2264.26	2649.31	2757.91	2965.72	3225.32	3580.82	3840.42
	54"(1372mm)	WUCZ-5454-	S N55	2297.20	2415.91	2834.50	2953.21	N/A	N/A	N/A	N/A
	60"(1524mm)	WUCZ-6060-	S N55	2438.74	2567.56	3019.69	3148.51	N/A	N/A	N/A	N/A

Adaptable Worksurfaces — Corner

Merger Corner – 90°

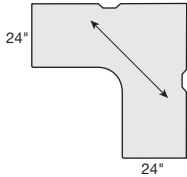
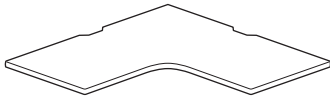

WUCQ-N44
Class CA

Unique Specifications

- 90° Merger is suggested alternative to using two perpendicular rectangular worksurfaces.
- Not designed for use with an adjustable keyboard pad.

To Order, Specify:

1) Product number, including:

1 Surface Option:

- L** Laminate
- W** Wood

2 Edge Option:

Laminate:

- J** Edgeband
- F** Knife

Wood:

- K** Edgeband
- U** Knife

3 Wireway Option:

- A** Notched
- C** Without

2) Laminate color or Wood finish color.

3) Edge trim color (laminite only).

Depth	Width	Number	① ② ③	HPL Edgeband (J)		HPL Knife Edge (F)		Wood Edgeband (K)		Wood Knife Edge (U)	
				A	B	A	B	A	B	A	B
18"(457mm)	36"(914mm)	WUCQ-3636-	S N33	\$ 810.76	\$ 859.50	\$ 1141.53	\$ 1190.27	\$1255.58	\$1294.48	\$ 1639.16	\$1678.06
	42"(1067mm)	WUCQ-4242-	S N33	886.87	935.61	1298.10	1346.84	1389.17	1428.07	1715.27	1754.17
	48"(1219mm)	WUCQ-4848-	S N33	1054.23	1102.97	1507.12	1555.86	1598.82	1637.72	2125.26	2164.16
	54"(1372mm)	WUCQ-5454-	S N33	1223.30	1272.04	1729.55	1778.29	N/A	N/A	N/A	N/A
24"(610mm)	36"(914mm)	WUCQ-3636-	S N44	\$ 841.21	\$ 889.95	\$ 1171.98	\$ 1220.72	\$1286.03	\$1324.93	\$ 1669.61	\$ 1708.51
	42"(1067mm)	WUCQ-4242-	S N44	917.32	966.06	1328.55	1377.29	1419.62	1458.52	1745.72	1784.62
	48"(1219mm)	WUCQ-4848-	S N44	1084.68	1133.42	1537.57	1586.31	1629.27	1668.17	2155.71	2194.61
	54"(1372mm)	WUCQ-5454-	S N44	1253.75	1302.49	1760.00	1808.74	N/A	N/A	N/A	N/A
30"(762mm)	36"(914mm)	WUCQ-3636-	S N55	\$ 969.69	\$ 1018.43	\$1300.46	\$1349.20	\$ 1414.51	\$ 1453.41	\$1798.09	\$1836.99
	42"(1067mm)	WUCQ-4242-	S N55	1045.80	1094.54	1457.03	1505.77	1548.10	1587.00	1874.20	1913.10
	48"(1219mm)	WUCQ-4848-	S N55	1213.16	1261.90	1666.05	1714.79	N/A	N/A	N/A	N/A
	54"(1372mm)	WUCQ-5454-	S N55	1382.23	1430.97	1888.48	1937.22	N/A	N/A	N/A	N/A

Adaptable Worksurfaces — Corner

Straight Front Corner – 90°

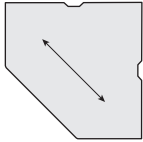
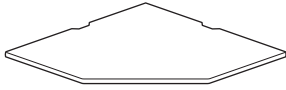

WUCA-L
Class CA

To Order, Specify:

1) Product number, including:

1 Surface Option:

- L** Laminate
- W** Wood

2 Edge Option:

Laminate:

- J** Edgeband
- F** Knife

Wood:

- K** Edgeband
- U** Knife

3 Wireway Option:

- A** Notched
- C** Without

2) Laminate color or Wood finish color.

3) Edge trim color (laminite only).

Depth	Width	Number	① ② ③	HPL Edgeband (J)		HPL Knife Edge (F)		Wood Edgeband (K)		Wood Knife Edge (U)	
				A	B	A	B	A	B	A	B
18"(457mm)	36"(914mm)	WUCA-3636-	■ S N33	\$ 894.11	\$ 943.36	\$ 1221.59	\$ 1270.84	\$ 1299.39	\$ 1355.19	\$ 1686.07	\$ 1741.87
	42"(1067mm)	WUCA-4242-	■ S N33	953.87	1010.69	1313.19	1370.01	1414.31	1498.02	1846.16	1929.87
	48"(1219mm)	WUCA-4848-	■ S N33	1105.55	1169.94	1496.71	1561.10	1621.15	1732.77	2098.17	2209.79
	54"(1372mm)	WUCA-5454-	■ S N33	1158.73	1230.69	1581.73	1653.69	N/A	N/A	N/A	N/A
24"(610mm)	36"(914mm)	WUCA-3636-	■ S N44	\$ 923.65	\$ 972.90	\$ 1251.13	\$ 1300.38	\$ 1328.93	\$ 1384.73	\$ 1715.61	\$ 1771.41
	42"(1067mm)	WUCA-4242-	■ S N44	983.41	1040.23	1342.73	1399.55	1443.85	1527.56	1875.70	1959.41
	48"(1219mm)	WUCA-4848-	■ S N44	1135.09	1199.48	1526.25	1590.64	1650.69	1762.31	2127.71	2239.33
	54"(1372mm)	WUCA-5454-	■ S N44	1188.27	1260.23	1611.27	1683.23	N/A	N/A	N/A	N/A
30"(762mm)	36"(914mm)	WUCA-3636-	■ S N55	\$ 1048.41	\$ 1097.66	\$ 1375.89	\$ 1425.14	\$ 1453.69	\$ 1509.49	\$ 1840.37	\$ 1896.17
	42"(1067mm)	WUCA-4242-	■ S N55	1108.17	1164.99	1467.49	1524.31	1568.61	1652.32	2000.46	2084.17
	48"(1219mm)	WUCA-4848-	■ S N55	1259.85	1324.24	1651.01	1715.40	N/A	N/A	N/A	N/A
	54"(1372mm)	WUCA-5454-	■ S N55	1313.03	1384.99	1736.03	1807.99	N/A	N/A	N/A	N/A

Adaptable Worksurfaces — Corner

Wrap-Around Corner – 90°

Wrap-Around

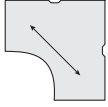

WUCR

Wrap-Around Transitional

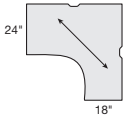
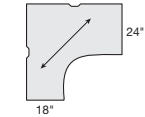
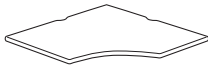

WUCT
Class CA

To Order, Specify:

1) Product number, including:

1 Surface Option:

- L** Laminate
- W** Wood

2 Edge Option:

Laminate:

- J** Edgeband
- F** Knife

Wood:

- K** Edgeband
- U** Knife

3 Wireway Option:

- A** Notched
- C** Without

2) Laminate color or Wood finish color.

3) Edge trim color (laminite only).

Left/Right Depth	Width	Number 1 2 3	HPL Edgeband (J)		HPL Knife Edge (F)		Wood Edgeband (K)		Wood Knife Edge (U)			
			A	B	A	B	A	B	A	B		
90° Wrap-Around												
18"(457mm)	36"(914mm)	WUCR-3636-	S	N33	\$ 857.21	\$ 904.41	\$ 1177.72	\$ 1224.92	\$ 1554.17	\$ 1710.52	\$ 1932.29	\$ 2088.64
	42"(1067mm)	WUCR-4242-	S	N33	983.69	1038.99	1323.82	1379.12	1724.21	1911.22	2146.85	2333.86
	48"(1219mm)	WUCR-4848-	S	N33	1110.17	1173.57	1469.92	1533.32	1894.25	2111.92	2361.41	2579.08
	54"(1372mm)	WUCR-5454-	S	N33	1236.65	1308.15	1616.02	1687.52	N/A	N/A	N/A	N/A
24"(610mm)	36"(914mm)	WUCR-3636-	S	N44	\$ 933.21	\$ 992.85	\$ 1261.46	\$ 1321.10	\$ 1655.53	\$ 1827.50	\$ 2033.65	\$ 2205.62
	42"(1067mm)	WUCR-4242-	S	N44	1059.69	1127.43	1407.56	1475.30	1825.57	2028.20	2248.21	2450.84
	48"(1219mm)	WUCR-4848-	S	N44	1186.17	1262.01	1553.66	1629.50	1995.61	2228.90	2462.77	2696.06
	54"(1372mm)	WUCR-5454-	S	N44	1312.65	1396.59	1699.76	1783.70	N/A	N/A	N/A	N/A
30"(762mm)	36"(914mm)	WUCR-3636-	S	N55	\$ 1009.21	\$ 1081.29	\$ 1345.20	\$ 1417.28	\$ 1756.89	\$ 1944.48	\$ 2135.01	\$ 2322.60
	42"(1067mm)	WUCR-4242-	S	N55	1135.69	1215.87	1491.30	1571.48	1926.93	2145.18	2349.57	2567.82
	48"(1219mm)	WUCR-4848-	S	N55	1262.17	1350.45	1637.40	1725.68	N/A	N/A	N/A	N/A
	54"(1372mm)	WUCR-5454-	S	N55	1388.65	1485.03	1783.50	1879.88	N/A	N/A	N/A	N/A
90° Wrap-Around Transitional												
18"(457mm)/24"(610mm)	36"(914mm)	WUCT-3636-	S	N34	\$ 895.21	\$ 948.63	\$ 1219.59	\$ 1273.01	\$ 1604.85	\$ 1769.01	\$ 1982.97	\$ 2147.13
	42"(1067mm)	WUCT-4242-	S	N34	1021.69	1083.21	1365.69	1427.21	1774.89	1969.71	2197.53	2392.35
	48"(1219mm)	WUCT-4848-	S	N34	1148.17	1217.79	1511.79	1581.41	1944.93	2170.41	2412.09	2637.57
	54"(1372mm)	WUCT-5454-	S	N34	1274.65	1352.37	1657.89	1735.61	N/A	N/A	N/A	N/A
24"(610mm)/18"(457mm)	36"(914mm)	WUCT-3636-	S	N43	\$ 895.21	\$ 948.63	\$ 1219.59	\$ 1273.01	\$ 1604.85	\$ 1769.01	\$ 1982.97	\$ 2147.13
	42"(1067mm)	WUCT-4242-	S	N43	1021.69	1083.21	1365.69	1427.21	1774.89	1969.71	2197.53	2392.35
	48"(1219mm)	WUCT-4848-	S	N43	1148.17	1217.79	1511.79	1581.41	1944.93	2170.41	2412.09	2637.57
	54"(1372mm)	WUCT-5454-	S	N43	1274.65	1352.37	1657.89	1735.61	N/A	N/A	N/A	N/A
24"(610mm)/30"(762mm)	36"(914mm)	WUCT-3636-	S	N45	\$ 971.21	\$ 1037.07	\$ 1303.33	\$ 1369.19	\$ 1706.21	\$ 1885.99	\$ 2084.33	\$ 2264.11
	42"(1067mm)	WUCT-4242-	S	N45	1097.69	1171.65	1449.43	1523.39	1876.25	2086.69	2298.89	2509.33
	48"(1219mm)	WUCT-4848-	S	N45	1224.17	1306.23	1595.53	1677.59	N/A	N/A	N/A	N/A
	54"(1372mm)	WUCT-5454-	S	N45	1350.65	1440.81	1741.63	1831.79	N/A	N/A	N/A	N/A
30"(762mm)/24"(610mm)	36"(914mm)	WUCT-3636-	S	N54	\$ 971.21	\$ 1037.07	\$ 1303.33	\$ 1369.19	\$ 1706.21	\$ 1885.99	\$ 2084.33	\$ 2264.11
	42"(1067mm)	WUCT-4242-	S	N54	1097.69	1171.65	1449.43	1523.39	1876.25	2086.69	2298.89	2509.33
	48"(1219mm)	WUCT-4848-	S	N54	1224.17	1306.23	1595.53	1677.59	N/A	N/A	N/A	N/A
	54"(1372mm)	WUCT-5454-	S	N54	1350.65	1440.81	1741.63	1831.79	N/A	N/A	N/A	N/A

Adaptable Worksurfaces — Corner

Wrap-Around Extended Corner – 90°

Wrap-Around Extended

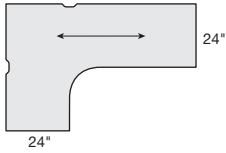
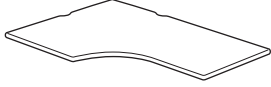

(Right-hand orientation)
WUCE-R44

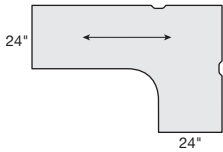

(Left-hand orientation)
WUCE-L44

Wrap-Around Extended Transitional

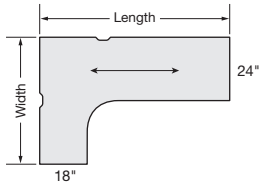

(Right-hand orientation)
WUCX-R34

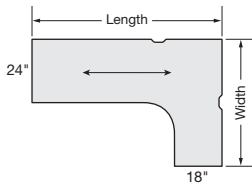

(Left-hand orientation)
WUCX-L43
Class CA

To Order, Specify:

1) Product number, including:

1 Surface Option:

- L** Laminate
- W** Wood

2 Edge Option:

Laminate:

- J** Edgeband
- F** Knife

Wood:

- K** Edgeband
- U** Knife

3 Wireway Option:

- A** Notched
- C** Without

4 Orientation (as seated):

- R** Right-hand
- L** Left-hand

2) Laminate color or Wood finish color.

3) Edge trim color (laminated only).

Adaptable Worksurfaces — Corner

Wrap-Around Extended Corner – 90°

Depth	Width	Length	Number	① ② ③ ④	HPL Edgeband (J)		HPL Knife Edge (F)		Wood Edgeband (K)		Wood Knife Edge (U)		
					A	B	A	B	A	B	A	B	
90° Wrap-Around Extended													
18"(457mm)	36"(914mm)	42"(1067mm)	WUCE-3642-	S	33	\$ 1201.28	\$ 1273.61	\$ 1653.60	\$ 1725.93	\$ 1952.93	\$ 2087.53	\$ 2504.63	\$ 2639.23
		48"(1219mm)	WUCE-3648-	S	33	1217.05	1290.26	1685.51	1758.72	1969.37	2106.95	2540.57	2678.15
		54"(1372mm)	WUCE-3654-	S	33	1232.82	1306.91	1717.42	1791.51	1985.81	2126.37	2576.51	2717.07
		60"(1524mm)	WUCE-3660-	S	33	1248.59	1323.56	1749.33	1824.30	2002.25	2145.79	2612.45	2755.99
		66"(1676mm)	WUCE-3666-	S	33	1380.56	1456.41	1897.44	1973.29	2207.15	2353.67	2836.85	2983.37
24"(610mm)	36"(914mm)	42"(1067mm)	WUCE-3642-	S	44	\$ 1245.90	\$ 1321.81	\$ 1698.22	\$ 1774.13	\$ 1994.19	\$ 2136.29	\$ 2545.89	\$ 2687.99
		48"(1219mm)	WUCE-3648-	S	44	1261.67	1338.46	1730.13	1806.92	2010.63	2155.71	2581.83	2726.91
		54"(1372mm)	WUCE-3654-	S	44	1277.44	1355.11	1762.04	1839.71	2027.07	2175.13	2617.77	2765.83
		60"(1524mm)	WUCE-3660-	S	44	1293.21	1371.76	1793.95	1872.50	2043.51	2194.55	2653.71	2804.75
		66"(1676mm)	WUCE-3666-	S	44	1425.18	1504.61	1942.06	2021.49	2248.41	2402.43	2878.11	3032.13
30"(762mm)	36"(914mm)	42"(1067mm)	WUCE-3642-	S	55	\$ 1478.94	\$ 1558.43	\$ 1931.26	\$ 2010.75	\$ 2223.87	\$ 2373.47	\$ 2775.57	\$ 2925.17
		48"(1219mm)	WUCE-3648-	S	55	1494.71	1575.08	1963.17	2043.54	2240.31	2392.89	2811.51	2964.09
		54"(1372mm)	WUCE-3654-	S	55	1510.48	1591.73	1995.08	2076.33	2256.75	2412.31	2847.45	3003.01
		60"(1524mm)	WUCE-3660-	S	55	1526.25	1608.38	2026.99	2109.12	2273.19	2431.73	2883.39	3041.93
		66"(1676mm)	WUCE-3666-	S	55	1658.22	1741.23	2175.10	2258.11	2478.09	2639.61	3107.79	3269.31
18"(457mm)	42"(1067mm)	48"(1219mm)	WUCE-4248-	S	33	\$ 1232.82	\$ 1306.91	\$ 1717.42	\$ 1791.51	\$ 1985.81	\$ 2126.37	\$ 2576.51	\$ 2717.07
		54"(1372mm)	WUCE-4254-	S	33	1248.59	1323.56	1749.33	1824.30	2002.25	2145.79	2612.45	2755.99
		60"(1524mm)	WUCE-4260-	S	33	1264.36	1340.21	1781.24	1857.09	2018.69	2165.21	2648.39	2794.91
		66"(1676mm)	WUCE-4266-	S	33	1425.38	1502.11	1958.40	2035.13	2223.59	2373.09	2872.79	3022.29
		72"(1829mm)	WUCE-4272-	S	33	1537.49	1615.10	2086.65	2164.26	2433.49	2585.97	3102.19	3254.67
24"(610mm)	42"(1067mm)	48"(1219mm)	WUCE-4248-	S	44	\$ 1277.44	\$ 1355.11	\$ 1762.04	\$ 1839.71	\$ 2027.07	\$ 2175.13	\$ 2617.77	\$ 2765.83
		54"(1372mm)	WUCE-4254-	S	44	1293.21	1371.76	1793.95	1872.50	2043.51	2194.55	2653.71	2804.75
		60"(1524mm)	WUCE-4260-	S	44	1308.98	1388.41	1825.86	1905.29	2059.95	2213.97	2689.65	2843.67
		66"(1676mm)	WUCE-4266-	S	44	1470.00	1550.31	2003.02	2083.33	2264.85	2421.85	2914.05	3071.05
		72"(1829mm)	WUCE-4272-	S	44	1582.11	1663.30	2131.27	2212.46	2474.75	2634.73	3143.45	3303.43
30"(762mm)	42"(1067mm)	48"(1219mm)	WUCE-4248-	S	55	\$ 1510.48	\$ 1591.73	\$ 1995.08	\$ 2076.33	\$ 2256.75	\$ 2412.31	\$ 2847.45	\$ 3003.01
		54"(1372mm)	WUCE-4254-	S	55	1526.25	1608.38	2026.99	2109.12	2273.19	2431.73	2883.39	3041.93
		60"(1524mm)	WUCE-4260-	S	55	1542.02	1625.03	2058.90	2141.91	2289.63	2451.15	2919.33	3080.85
		66"(1676mm)	WUCE-4266-	S	55	1703.04	1786.93	2236.06	2319.95	2494.53	2659.03	3143.73	3308.23
		72"(1829mm)	WUCE-4272-	S	55	1815.15	1899.92	2364.31	2449.08	2704.43	2871.91	3373.13	3540.61
18"(457mm)	48"(1219mm)	54"(1372mm)	WUCE-4854-	S	33	\$ 1264.36	\$ 1340.21	\$ 1781.24	\$ 1857.09	\$ 2018.69	\$ 2165.21	\$ 2648.39	\$ 2794.91
		60"(1524mm)	WUCE-4860-	S	33	1280.13	1356.86	1813.15	1889.88	2035.13	2184.63	2684.33	2833.83
		66"(1676mm)	WUCE-4866-	S	33	1470.20	1547.81	2019.36	2096.97	2240.03	2392.51	2908.73	3061.21
		72"(1829mm)	WUCE-4872-	S	33	1582.31	1660.80	2147.61	2226.10	2449.93	2605.39	3138.13	3293.59
		24"(610mm)	48"(1219mm)	54"(1372mm)	WUCE-4854-	S	44	\$ 1308.98	\$ 1388.41	\$ 1825.86	\$ 1905.29	\$ 2059.95	\$ 2213.97
30"(762mm)	48"(1219mm)	54"(1372mm)	WUCE-4854-	S	55	\$ 1542.02	\$ 1625.03	\$ 2058.90	\$ 2141.91	\$ 2289.63	\$ 2451.15	\$ 2919.33	\$ 3080.85
		60"(1524mm)	WUCE-4860-	S	55	1557.79	1641.68	2090.81	2174.70	2306.07	2470.57	2955.27	3119.77
		66"(1676mm)	WUCE-4866-	S	55	1747.86	1832.63	2297.02	2381.79	2510.97	2678.45	3179.67	3347.15
		72"(1829mm)	WUCE-4872-	S	55	1859.97	1945.62	2425.27	2510.92	2720.87	2891.33	3409.07	3579.53
		18"(457mm)	54"(1372mm)	60"(1524mm)	WUCE-5460-	S	33	\$ 1295.90	\$ 1373.51	\$ 1845.06	\$ 1922.67	N/A	N/A
24"(610mm)	54"(1372mm)	66"(1676mm)	WUCE-5466-	S	33	1515.02	1593.51	2080.32	2158.81	N/A	N/A	N/A	N/A
		72"(1829mm)	WUCE-5472-	S	33	1627.13	1706.50	2208.57	2287.94	N/A	N/A	N/A	N/A
		60"(1524mm)	WUCE-5460-	S	44	\$ 1340.52	\$ 1421.71	\$ 1889.68	\$ 1970.87	N/A	N/A	N/A	N/A
30"(762mm)	54"(1372mm)	66"(1676mm)	WUCE-5466-	S	44	1559.64	1641.71	2124.94	2207.01	N/A	N/A	N/A	N/A
		72"(1829mm)	WUCE-5472-	S	44	1671.75	1754.70	2253.19	2336.14	N/A	N/A	N/A	N/A
		60"(1524mm)	WUCE-5460-	S	55	\$ 1573.56	\$ 1658.33	\$ 2122.72	\$ 2207.49	N/A	N/A	N/A	N/A
18"(457mm)	60"(1524mm)	66"(1676mm)	WUCE-6066-	S	33	\$ 1559.84	\$ 1639.21	\$ 2141.28	\$ 2220.65	N/A	N/A	N/A	N/A
		72"(1829mm)	WUCE-6072-	S	33	1671.95	1752.20	2269.53	2349.78	N/A	N/A	N/A	N/A
		66"(1676mm)	WUCE-6066-	S	44	\$ 1604.46	\$ 1687.41	\$ 2185.90	\$ 2268.85	N/A	N/A	N/A	N/A
24"(610mm)	60"(1524mm)	72"(1829mm)	WUCE-6072-	S	44	1716.57	1800.40	2314.15	2397.98	N/A	N/A	N/A	N/A
		66"(1676mm)	WUCE-6066-	S	55	\$ 1837.50	\$ 1924.03	\$ 2418.94	\$ 2505.47	N/A	N/A	N/A	N/A
30"(762mm)	60"(1524mm)	72"(1829mm)	WUCE-6072-	S	55	1949.61	2037.02	2547.19	2634.60	N/A	N/A	N/A	N/A

Adaptable Worksurfaces — Corner

Wrap-Around Extended Corner – 90°

Left/Right Depth	Width	Length	Number ①② ③④	HPL Edgeband (J)		HPL Knife Edge (F)		Wood Edgeband (K)		Wood Knife Edge (U)			
				A	B	A	B	A	B	A	B		
90° Wrap-Around Transitional Extended													
18"(457mm)/24"(610mm)	36"(914mm)	42"(1067mm)	WUCX-3642-	S	34	\$1354.82	\$1428.94	\$ 1807.14	\$ 1881.26	\$ 2192.26	\$ 2330.61	\$ 2743.96	\$ 2882.31
		48"(1219mm)	WUCX-3648-	S	34	1370.59	1445.59	1839.05	1914.05	2208.70	2350.03	2779.90	2921.23
		54"(1372mm)	WUCX-3654-	S	34	1386.36	1462.24	1870.96	1946.84	2225.14	2369.45	2815.84	2960.15
		60"(1524mm)	WUCX-3660-	S	34	1402.13	1478.89	1902.87	1979.63	2241.58	2388.87	2851.78	2999.07
		66"(1676mm)	WUCX-3666-	S	34	1534.10	1611.74	2050.98	2128.62	2446.48	2596.75	3076.18	3226.45
		72"(1829mm)	WUCX-3672-	S	34	1646.21	1724.73	2179.23	2257.75	2656.38	2809.63	3305.58	3458.83
24"(610mm)/18"(457mm)	36"(914mm)	42"(1067mm)	WUCX-3642-	S	43	\$1354.82	\$1428.94	\$ 1807.14	\$ 1881.26	\$ 2192.26	\$ 2330.61	\$ 2743.96	\$ 2882.31
		48"(1219mm)	WUCX-3648-	S	43	1370.59	1445.59	1839.05	1914.05	2208.70	2350.03	2779.90	2921.23
		54"(1372mm)	WUCX-3654-	S	43	1386.36	1462.24	1870.96	1946.84	2225.14	2369.45	2815.84	2960.15
		60"(1524mm)	WUCX-3660-	S	43	1402.13	1478.89	1902.87	1979.63	2241.58	2388.87	2851.78	2999.07
		66"(1676mm)	WUCX-3666-	S	43	1534.10	1611.74	2050.98	2128.62	2446.48	2596.75	3076.18	3226.45
		72"(1829mm)	WUCX-3672-	S	43	1646.21	1724.73	2179.23	2257.75	2656.38	2809.63	3305.58	3458.83
24"(610mm)/30"(762mm)	36"(914mm)	42"(1067mm)	WUCX-3642-	S	45	\$1399.44	\$ 1477.14	\$ 1851.76	\$ 1929.46	\$ 2233.52	\$ 2379.37	\$ 2785.22	\$ 2931.07
		48"(1219mm)	WUCX-3648-	S	45	1415.21	1493.79	1883.67	1962.25	2249.96	2398.79	2821.16	2969.99
		54"(1372mm)	WUCX-3654-	S	45	1430.98	1510.44	1915.58	1995.04	2266.40	2418.21	2857.10	3008.91
		60"(1524mm)	WUCX-3660-	S	45	1446.75	1527.09	1947.49	2027.83	2282.84	2437.63	2893.04	3047.83
		66"(1676mm)	WUCX-3666-	S	45	1578.72	1659.94	2095.60	2176.82	2487.74	2645.51	3117.44	3275.21
		72"(1829mm)	WUCX-3672-	S	45	1690.83	1772.93	2223.85	2305.95	2697.64	2858.39	3346.84	3507.59
30"(762mm)/24"(610mm)	36"(914mm)	42"(1067mm)	WUCX-3642-	S	54	\$1399.44	\$ 1477.14	\$ 1851.76	\$ 1929.46	\$ 2233.52	\$ 2379.37	\$ 2785.22	\$ 2931.07
		48"(1219mm)	WUCX-3648-	S	54	1415.21	1493.79	1883.67	1962.25	2249.96	2398.79	2821.16	2969.99
		54"(1372mm)	WUCX-3654-	S	54	1430.98	1510.44	1915.58	1995.04	2266.40	2418.21	2857.10	3008.91
		60"(1524mm)	WUCX-3660-	S	54	1446.75	1527.09	1947.49	2027.83	2282.84	2437.63	2893.04	3047.83
		66"(1676mm)	WUCX-3666-	S	54	1578.72	1659.94	2095.60	2176.82	2487.74	2645.51	3117.44	3275.21
		72"(1829mm)	WUCX-3672-	S	54	1690.83	1772.93	2223.85	2305.95	2697.64	2858.39	3346.84	3507.59
18"(457mm)/24"(610mm)	42"(1067mm)	48"(1219mm)	WUCX-4248-	S	34	\$1386.36	\$1462.24	\$ 1870.96	\$ 1946.84	\$ 2225.14	\$ 2369.45	\$ 2815.84	\$ 2960.15
		54"(1372mm)	WUCX-4254-	S	34	1402.13	1478.89	1902.87	1979.63	2241.58	2388.87	2851.78	2999.07
		60"(1524mm)	WUCX-4260-	S	34	1417.90	1495.54	1934.78	2012.42	2258.02	2408.29	2887.72	3037.99
		66"(1676mm)	WUCX-4266-	S	34	1578.92	1657.44	2111.94	2190.46	2462.92	2616.17	3112.12	3265.37
		72"(1829mm)	WUCX-4272-	S	34	1691.03	1770.43	2240.19	2319.59	2672.82	2829.05	3341.52	3497.75
		24"(610mm)/18"(457mm)	42"(1067mm)	48"(1219mm)	WUCX-4248-	S	43	\$1386.36	\$1462.24	\$ 1870.96	\$ 1946.84	\$ 2225.14	\$ 2369.45
54"(1372mm)	WUCX-4254-			S	43	1402.13	1478.89	1902.87	1979.63	2241.58	2388.87	2851.78	2999.07
60"(1524mm)	WUCX-4260-			S	43	1417.90	1495.54	1934.78	2012.42	2258.02	2408.29	2887.72	3037.99
66"(1676mm)	WUCX-4266-			S	43	1578.92	1657.44	2111.94	2190.46	2462.92	2616.17	3112.12	3265.37
72"(1829mm)	WUCX-4272-			S	43	1691.03	1770.43	2240.19	2319.59	2672.82	2829.05	3341.52	3497.75
24"(610mm)/30"(762mm)	42"(1067mm)			48"(1219mm)	WUCX-4248-	S	45	\$1430.98	\$ 1510.44	\$ 1915.58	\$ 1995.04	\$ 2266.40	\$ 2418.21
		54"(1372mm)	WUCX-4254-	S	45	1446.75	1527.09	1947.49	2027.83	2282.84	2437.63	2893.04	3047.83
		60"(1524mm)	WUCX-4260-	S	45	1462.52	1543.74	1979.40	2060.62	2299.28	2457.05	2928.98	3086.75
		66"(1676mm)	WUCX-4266-	S	45	1623.54	1705.64	2156.56	2238.66	2504.18	2664.93	3153.38	3314.13
		72"(1829mm)	WUCX-4272-	S	45	1735.65	1818.63	2284.81	2367.79	2714.08	2877.81	3382.78	3546.51
		30"(762mm)/24"(610mm)	42"(1067mm)	48"(1219mm)	WUCX-4248-	S	54	\$1430.98	\$ 1510.44	\$ 1915.58	\$ 1995.04	\$ 2266.40	\$ 2418.21
54"(1372mm)	WUCX-4254-			S	54	1446.75	1527.09	1947.49	2027.83	2282.84	2437.63	2893.04	3047.83
60"(1524mm)	WUCX-4260-			S	54	1462.52	1543.74	1979.40	2060.62	2299.28	2457.05	2928.98	3086.75
66"(1676mm)	WUCX-4266-			S	54	1623.54	1705.64	2156.56	2238.66	2504.18	2664.93	3153.38	3314.13
72"(1829mm)	WUCX-4272-			S	54	1735.65	1818.63	2284.81	2367.79	2714.08	2877.81	3382.78	3546.51

Adaptable Worksurfaces — Corner

Wrap-Around Extended Corner – 90°

Left/Right Depth	Width	Length	Number ①② ③④	HPL Edgeband (J)		HPL Knife Edge (F)		Wood Edgeband (K)		Wood Knife Edge (U)			
				A	B	A	B	A	B	A	B		
18"(457mm)/24"(610mm)	48"(1219mm)	54"(1372mm)	WUCX-4854-	S	34	\$ 1417.90	\$1495.54	\$ 1934.78	\$ 2012.42	\$2258.02	\$2408.29	\$ 2887.72	\$3037.99
		60"(1524mm)	WUCX-4860-	S	34	1433.67	1512.19	1966.69	2045.21	2274.46	2427.71	2923.66	3076.91
		66"(1676mm)	WUCX-4866-	S	34	1623.74	1703.14	2172.90	2252.30	2479.36	2635.59	3148.06	3304.29
		72"(1829mm)	WUCX-4872-	S	34	1735.85	1816.13	2301.15	2381.43	2689.26	2848.47	3377.46	3536.67
24"(610mm)/18"(457mm)	48"(1219mm)	54"(1372mm)	WUCX-4854-	S	43	\$ 1417.90	\$1495.54	\$ 1934.78	\$ 2012.42	\$2258.02	\$2408.29	\$ 2887.72	\$3037.99
		60"(1524mm)	WUCX-4860-	S	43	1433.67	1512.19	1966.69	2045.21	2274.46	2427.71	2923.66	3076.91
		66"(1676mm)	WUCX-4866-	S	43	1623.74	1703.14	2172.90	2252.30	2479.36	2635.59	3148.06	3304.29
		72"(1829mm)	WUCX-4872-	S	43	1735.85	1816.13	2301.15	2381.43	2689.26	2848.47	3377.46	3536.67
24"(610mm)/30"(762mm)	48"(1219mm)	54"(1372mm)	WUCX-4854-	S	45	\$1462.52	\$1543.74	\$ 1979.40	\$2060.62	\$2299.28	\$ 2457.05	\$2928.98	\$3086.75
		60"(1524mm)	WUCX-4860-	S	45	1478.29	1560.39	2011.31	2093.41	2315.72	2476.47	2964.92	3125.67
		66"(1676mm)	WUCX-4866-	S	45	1668.36	1751.34	2217.52	2300.50	2520.62	2684.35	3189.32	3353.05
		72"(1829mm)	WUCX-4872-	S	45	1780.47	1864.33	2345.77	2429.63	2730.52	2897.23	3418.72	3585.43
30"(762mm)/24"(610mm)	48"(1219mm)	54"(1372mm)	WUCX-4854-	S	54	\$1462.52	\$1543.74	\$ 1979.40	\$2060.62	\$2299.28	\$ 2457.05	\$2928.98	\$3086.75
		60"(1524mm)	WUCX-4860-	S	54	1478.29	1560.39	2011.31	2093.41	2315.72	2476.47	2964.92	3125.67
		66"(1676mm)	WUCX-4866-	S	54	1668.36	1751.34	2217.52	2300.50	2520.62	2684.35	3189.32	3353.05
		72"(1829mm)	WUCX-4872-	S	54	1780.47	1864.33	2345.77	2429.63	2730.52	2897.23	3418.72	3585.43
18"(457mm)/24"(610mm)	54"(1372mm)	60"(1524mm)	WUCX-5460-	S	34	\$1449.44	\$1528.84	\$1998.60	\$2078.00	N/A	N/A	N/A	N/A
		66"(1676mm)	WUCX-5466-	S	34	1668.56	1748.84	2233.86	2314.14	N/A	N/A	N/A	N/A
		72"(1829mm)	WUCX-5472-	S	34	1780.67	1861.83	2362.11	2443.27	N/A	N/A	N/A	N/A
24"(610mm)/18"(457mm)	54"(1372mm)	60"(1524mm)	WUCX-5460-	S	43	\$1449.44	\$1528.84	\$1998.60	\$2078.00	N/A	N/A	N/A	N/A
		66"(1676mm)	WUCX-5466-	S	43	1668.56	1748.84	2233.86	2314.14	N/A	N/A	N/A	N/A
		72"(1829mm)	WUCX-5472-	S	43	1780.67	1861.83	2362.11	2443.27	N/A	N/A	N/A	N/A
24"(610mm)/30"(762mm)	54"(1372mm)	60"(1524mm)	WUCX-5460-	S	45	\$1494.06	\$1577.04	\$2043.22	\$ 2126.20	N/A	N/A	N/A	N/A
		66"(1676mm)	WUCX-5466-	S	45	1713.18	1797.04	2278.48	2362.34	N/A	N/A	N/A	N/A
		72"(1829mm)	WUCX-5472-	S	45	1825.29	1910.03	2406.73	2491.47	N/A	N/A	N/A	N/A
30"(762mm)/24"(610mm)	54"(1372mm)	60"(1524mm)	WUCX-5460-	S	54	\$1494.06	\$1577.04	\$2043.22	\$ 2126.20	N/A	N/A	N/A	N/A
		66"(1676mm)	WUCX-5466-	S	54	1713.18	1797.04	2278.48	2362.34	N/A	N/A	N/A	N/A
		72"(1829mm)	WUCX-5472-	S	54	1825.29	1910.03	2406.73	2491.47	N/A	N/A	N/A	N/A
18"(457mm)/24"(610mm)	60"(1524mm)	66"(1676mm)	WUCX-6066-	S	34	\$ 1713.38	\$1794.54	\$2294.82	\$ 2375.98	N/A	N/A	N/A	N/A
		72"(1829mm)	WUCX-6072-	S	34	1825.49	1907.53	2423.07	2505.11	N/A	N/A	N/A	N/A
24"(610mm)/18"(457mm)	60"(1524mm)	66"(1676mm)	WUCX-6066-	S	43	\$ 1713.38	\$1794.54	\$2294.82	\$ 2375.98	N/A	N/A	N/A	N/A
		72"(1829mm)	WUCX-6072-	S	43	1825.49	1907.53	2423.07	2505.11	N/A	N/A	N/A	N/A
24"(610mm)/30"(762mm)	60"(1524mm)	66"(1676mm)	WUCX-6066-	S	45	\$1758.00	\$1842.74	\$2339.44	\$ 2424.18	N/A	N/A	N/A	N/A
		72"(1829mm)	WUCX-6072-	S	45	1870.11	1955.73	2467.69	2553.31	N/A	N/A	N/A	N/A
30"(762mm)/24"(610mm)	60"(1524mm)	66"(1676mm)	WUCX-6066-	S	54	\$1758.00	\$1842.74	\$2339.44	\$ 2424.18	N/A	N/A	N/A	N/A
		72"(1829mm)	WUCX-6072-	S	54	1870.11	1955.73	2467.69	2553.31	N/A	N/A	N/A	N/A

Adaptable Worksurfaces — Corner

Notched Corner – 90°

Notched

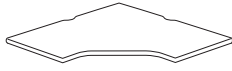

WUCN

Notched Transitional

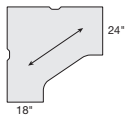

WUCH-N34

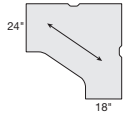

WUCH-N43

Class CA

To Order, Specify:

1) Product number, including:

1 Surface Option:

L Laminate

W Wood

2 Edge Option:

Laminate:

J Edgeband

F Knife

Wood:

K Edgeband

U Knife

3 Wireway Option:

A Notched

C Without

2) Laminate color or Wood finish color.

3) Edge trim color (laminite only).

Left/Right Depth	Width	Number ①②③	HPL Edgeband (J)		HPL Knife Edge (F)		Wood Edgeband (K)		Wood Knife Edge (U)			
			A	B	A	B	A	B	A	B		
Notched												
18"(457mm)	36"(914mm)	WUCN-3636-	S	N33	\$ 925.49	\$ 973.78	\$ 1247.92	\$ 1296.21	\$ 1342.88	\$ 1379.91	\$ 1721.37	\$ 1758.40
	42"(1067mm)	WUCN-4242-	S	N33	1039.80	1097.75	1396.48	1454.43	1516.70	1558.53	1935.34	1977.17
	48"(1219mm)	WUCN-4848-	S	N33	1155.72	1223.33	1553.50	1621.11	1690.52	1737.15	2157.34	2203.97
24"(610mm)	36"(914mm)	WUCN-3636-	S	N44	\$ 951.24	\$ 999.53	\$ 1273.67	\$ 1321.96	\$ 1368.63	\$ 1405.66	\$ 1747.12	\$ 1784.15
	42"(1067mm)	WUCN-4242-	S	N44	1065.55	1123.50	1422.23	1480.18	1542.45	1584.28	1961.09	2002.92
	48"(1219mm)	WUCN-4848-	S	N44	1181.47	1249.08	1579.25	1646.86	1716.27	1762.90	2183.09	2229.72
30"(762mm)	36"(914mm)	WUCN-3636-	S	N55	\$ 976.99	\$ 1025.28	\$ 1299.42	\$ 1347.71	\$ 1394.38	\$ 1431.41	\$ 1772.87	\$ 1809.90
	42"(1067mm)	WUCN-4242-	S	N55	1091.30	1149.25	1447.98	1505.93	1568.20	1610.03	1986.84	2028.67
	48"(1219mm)	WUCN-4848-	S	N55	1207.22	1274.83	1605.00	1672.61	N/A	N/A	N/A	N/A
	54"(1372mm)	WUCN-5454-	S	N55	1361.78	1439.05	1800.66	1877.93	N/A	N/A	N/A	N/A
Notched Transitional												
18"(457mm)/24"(610mm)	36"(914mm)	WUCH-3636-	S	N34	\$ 909.41	\$ 957.70	\$ 1231.84	\$ 1280.13	\$ 1326.80	\$ 1363.83	\$ 1705.29	\$ 1742.32
	42"(1067mm)	WUCH-4242-	S	N34	1023.72	1081.67	1380.40	1438.35	1500.62	1542.45	1919.26	1961.09
	48"(1219mm)	WUCH-4848-	S	N34	1139.64	1207.25	1537.42	1605.03	1674.44	1721.07	2141.26	2187.89
24"(610mm)/18"(457mm)	36"(914mm)	WUCH-3636-	S	N43	\$ 909.41	\$ 957.70	\$ 1231.84	\$ 1280.13	\$ 1326.80	\$ 1363.83	\$ 1705.29	\$ 1742.32
	42"(1067mm)	WUCH-4242-	S	N43	1023.72	1081.67	1380.40	1438.35	1500.62	1542.45	1919.26	1961.09
	48"(1219mm)	WUCH-4848-	S	N43	1139.64	1207.25	1537.42	1605.03	1674.44	1721.07	2141.26	2187.89
24"(610mm)/30"(762mm)	36"(914mm)	WUCH-3636-	S	N45	\$ 960.91	\$ 1009.20	\$ 1283.34	\$ 1331.63	\$ 1378.30	\$ 1415.33	\$ 1756.79	\$ 1793.82
	42"(1067mm)	WUCH-4242-	S	N45	1075.22	1133.17	1431.90	1489.85	1552.12	1593.95	1970.76	2012.59
	48"(1219mm)	WUCH-4848-	S	N45	1191.14	1258.75	1588.92	1656.53	N/A	N/A	N/A	N/A
30"(762mm)/24"(610mm)	36"(914mm)	WUCH-3636-	S	N54	\$ 960.91	\$ 1009.20	\$ 1283.34	\$ 1331.63	\$ 1378.30	\$ 1415.33	\$ 1756.79	\$ 1793.82
	42"(1067mm)	WUCH-4242-	S	N54	1075.22	1133.17	1431.90	1489.85	1552.12	1593.95	1970.76	2012.59
	48"(1219mm)	WUCH-4848-	S	N54	1191.14	1258.75	1588.92	1656.53	N/A	N/A	N/A	N/A
	54"(1372mm)	WUCH-5454-	S	N54	1345.70	1422.97	1784.58	1861.85	N/A	N/A	N/A	N/A

Adaptable Worksurfaces — Corner

Notch Extended Corner – 90°

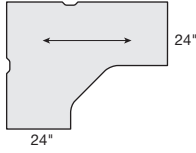
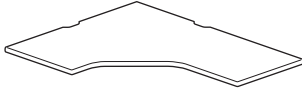

(Right-hand orientation)

WUCP-R44

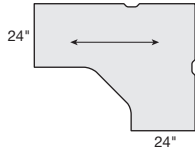

(Left-hand orientation)

WUCP-L44

Class CA

To Order, Specify:

1) Product number, including:

1 Surface Option:

- L** Laminate
- W** Wood

2 Edge Option:

Laminate:

- J** Edgeband
- F** Knife

Wood:

- K** Edgeband
- U** Knife

3 Wireway/Cutout Option:

- A** Notched
- C** Without

4 Orientation (as seated):

- R** Right-hand
- L** Left-hand

2) Laminate color or Wood finish color.

3) Edge trim color (laminite only).

Depth	Width	Length	Number	HPL Edgeband (J)		HPL Knife Edge (F)		Wood Edgeband (K)		Wood Knife Edge (U)			
				A	B	A	B	A	B	A	B		
18"(457mm)	36"(914mm)	42"(1067mm)	WUCP-3642-	S	33	\$ 1296.73	\$ 1380.46	\$ 1747.33	\$ 1831.06	\$ 1894.24	\$ 2020.64	\$ 2441.82	\$ 2568.22
		48"(1219mm)	WUCP-3648-	S	33	1329.56	1415.51	1796.40	1882.35	1952.53	2089.28	2525.11	2661.86
		54"(1372mm)	WUCP-3654-	S	33	1362.39	1450.56	1845.47	1933.64	2010.82	2157.92	2608.40	2755.50
		60"(1524mm)	WUCP-3660-	S	33	1395.22	1485.61	1894.54	1984.93	2069.11	2226.56	2691.69	2849.14
		66"(1676mm)	WUCP-3666-	S	33	1428.05	1520.66	1943.61	2036.22	2127.40	2295.20	2774.98	2942.78
		72"(1829mm)	WUCP-3672-	S	33	1639.81	1734.64	2171.61	2266.44	2364.82	2542.77	3037.20	3215.35
24"(610mm)	36"(914mm)	42"(1067mm)	WUCP-3642-	S	44	\$ 1333.82	\$ 1420.53	\$ 1784.42	\$ 1871.13	\$ 1923.70	\$ 2055.33	\$ 2471.28	\$ 2602.91
		48"(1219mm)	WUCP-3648-	S	44	1366.65	1455.58	1833.49	1922.42	1981.99	2123.97	2554.57	2696.55
		54"(1372mm)	WUCP-3654-	S	44	1399.48	1490.63	1882.56	1973.71	2040.28	2192.61	2637.86	2790.19
		60"(1524mm)	WUCP-3660-	S	44	1432.31	1525.68	1931.63	2025.00	2098.57	2261.25	2721.15	2883.83
		66"(1676mm)	WUCP-3666-	S	44	1465.14	1560.73	1980.70	2076.29	2156.86	2329.89	2804.44	2977.47
		72"(1829mm)	WUCP-3672-	S	44	1676.90	1774.71	2208.70	2306.51	2394.08	2577.46	3066.66	3250.04
30"(762mm)	36"(914mm)	42"(1067mm)	WUCP-3642-	S	55	\$ 1370.91	\$ 1460.60	\$ 1821.51	\$ 1911.20	\$ 1953.16	\$ 2090.02	\$ 2500.74	\$ 2637.60
		48"(1219mm)	WUCP-3648-	S	55	1403.74	1495.65	1870.58	1962.49	2011.45	2158.66	2584.03	2731.24
		54"(1372mm)	WUCP-3654-	S	55	1436.57	1530.70	1919.65	2013.78	2069.74	2227.30	2667.32	2824.88
		60"(1524mm)	WUCP-3660-	S	55	1469.40	1565.75	1968.72	2065.07	2128.03	2295.94	2750.61	2918.52
		66"(1676mm)	WUCP-3666-	S	55	1502.23	1600.80	2017.79	2116.36	2186.32	2364.58	2833.90	3012.16
		72"(1829mm)	WUCP-3672-	S	55	1713.99	1814.78	2245.79	2346.58	2423.54	2612.15	3096.12	3284.73
18"(457mm)	42"(1067mm)	48"(1219mm)	WUCP-4248-	S	33	\$ 1362.39	\$ 1450.56	\$ 1845.47	\$ 1933.64	\$ 2010.82	\$ 2157.92	\$ 2608.40	\$ 2755.50
		54"(1372mm)	WUCP-4254-	S	33	1395.22	1485.61	1894.54	1984.93	2069.11	2226.56	2691.69	2849.14
		60"(1524mm)	WUCP-4260-	S	33	1428.05	1520.66	1943.61	2036.22	2127.40	2295.20	2774.98	2942.78
		66"(1676mm)	WUCP-4266-	S	33	1460.88	1555.71	1992.68	2087.51	2185.69	2363.84	2858.27	3036.42
		72"(1829mm)	WUCP-4272-	S	33	1672.64	1769.69	2220.68	2317.73	2422.91	2611.41	3120.49	3308.99
		24"(610mm)	42"(1067mm)	48"(1219mm)	WUCP-4248-	S	44	\$ 1399.48	\$ 1490.63	\$ 1882.56	\$ 1973.71	\$ 2040.28	\$ 2192.61
54"(1372mm)	WUCP-4254-			S	44	1432.31	1525.68	1931.63	2025.00	2098.57	2261.25	2721.15	2883.83
60"(1524mm)	WUCP-4260-			S	44	1465.14	1560.73	1980.70	2076.29	2156.86	2329.89	2804.44	2977.47
66"(1676mm)	WUCP-4266-			S	44	1497.97	1595.78	2029.77	2127.58	2215.15	2398.53	2887.73	3071.11
72"(1829mm)	WUCP-4272-			S	44	1709.73	1809.76	2257.77	2357.80	2452.37	2646.10	3149.95	3343.68
30"(762mm)	42"(1067mm)			48"(1219mm)	WUCP-4248-	S	55	\$ 1436.57	\$ 1530.70	\$ 1919.65	\$ 2013.78	\$ 2069.74	\$ 2227.30
		54"(1372mm)	WUCP-4254-	S	55	1469.40	1565.75	1968.72	2065.07	2128.03	2295.94	2750.61	2918.52
		60"(1524mm)	WUCP-4260-	S	55	1502.23	1600.80	2017.79	2116.36	2186.32	2364.58	2833.90	3012.16
		66"(1676mm)	WUCP-4266-	S	55	1535.06	1635.85	2066.86	2167.65	2244.61	2433.22	2917.19	3105.80
		72"(1829mm)	WUCP-4272-	S	55	1746.82	1849.83	2294.86	2397.87	2481.83	2680.79	3179.41	3378.37

Adaptable Worksurfaces — Corner

Notch Extended Corner – 90°

Depth	Width	Length	Number 1 2 3 4	HPL Edgeband (J)		HPL Knife Edge (F)		Wood Edgeband (K)		Wood Knife Edge (U)	
				A	B	A	B	A	B	A	B
18"(457mm)	48"(1219mm)	54"(1372mm)	WUCP-4854- S 33	\$1428.05	\$1520.66	\$ 1943.61	\$2036.22	\$ 2127.40	\$2295.20	\$ 2774.98	\$ 2942.78
		60"(1524mm)	WUCP-4860- S 33	1460.88	1555.71	1992.68	2087.51	2185.69	2363.84	2858.27	3036.42
		66"(1676mm)	WUCP-4866- S 33	1493.71	1590.76	2041.75	2138.80	2243.98	2432.48	2941.56	3130.06
		72"(1829mm)	WUCP-4872- S 33	1705.47	1804.74	2269.75	2369.02	2481.20	2680.05	3203.78	3402.63
24"(610mm)	48"(1219mm)	54"(1372mm)	WUCP-4854- S 44	\$ 1465.14	\$ 1560.73	\$ 1980.70	\$ 2076.29	\$ 2156.86	\$ 2329.89	\$ 2804.44	\$ 2977.47
		60"(1524mm)	WUCP-4860- S 44	1497.97	1595.78	2029.77	2127.58	2215.15	2398.53	2887.73	3071.11
		66"(1676mm)	WUCP-4866- S 44	1530.80	1630.83	2078.84	2178.87	2273.44	2467.17	2971.02	3164.75
		72"(1829mm)	WUCP-4872- S 44	1742.56	1844.81	2306.84	2409.09	2510.66	2714.74	3233.24	3437.32
30"(762mm)	48"(1219mm)	54"(1372mm)	WUCP-4854- S 55	\$1502.23	\$1600.80	\$ 2017.79	\$ 2116.36	\$ 2186.32	\$ 2364.58	\$ 2833.90	\$ 3012.16
		60"(1524mm)	WUCP-4860- S 55	1535.06	1635.85	2066.86	2167.65	2244.61	2433.22	2917.19	3105.80
		66"(1676mm)	WUCP-4866- S 55	1567.89	1670.90	2115.93	2218.94	2302.90	2501.86	3000.48	3199.44
		72"(1829mm)	WUCP-4872- S 55	1779.65	1884.88	2343.93	2449.16	2540.12	2749.43	3262.70	3472.01
18"(457mm)	54"(1372mm)	60"(1524mm)	WUCP-5460- S 33	\$ 1493.71	\$ 1590.76	\$ 2041.75	\$ 2138.80	N/A	N/A	N/A	N/A
		66"(1676mm)	WUCP-5466- S 33	1526.54	1625.81	2090.82	2190.09	N/A	N/A	N/A	N/A
		72"(1829mm)	WUCP-5472- S 33	1738.30	1839.79	2318.82	2420.31	N/A	N/A	N/A	N/A
24"(610mm)	54"(1372mm)	60"(1524mm)	WUCP-5460- S 44	\$1530.80	\$1630.83	\$ 2078.84	\$ 2178.87	N/A	N/A	N/A	N/A
		66"(1676mm)	WUCP-5466- S 44	1563.63	1665.88	2127.91	2230.16	N/A	N/A	N/A	N/A
		72"(1829mm)	WUCP-5472- S 44	1775.39	1879.86	2355.91	2460.38	N/A	N/A	N/A	N/A
30"(762mm)	54"(1372mm)	60"(1524mm)	WUCP-5460- S 55	\$ 1567.89	\$ 1670.90	\$ 2115.93	\$ 2218.94	N/A	N/A	N/A	N/A
		66"(1676mm)	WUCP-5466- S 55	1600.72	1705.95	2165.00	2270.23	N/A	N/A	N/A	N/A
		72"(1829mm)	WUCP-5472- S 55	1812.48	1919.93	2393.00	2500.45	N/A	N/A	N/A	N/A
18"(457mm)	60"(1524mm)	66"(1676mm)	WUCP-6066- S 33	\$ 1559.37	\$ 1660.86	\$ 2139.89	\$ 2241.38	N/A	N/A	N/A	N/A
		72"(1829mm)	WUCP-6072- S 33	1771.13	1874.84	2367.89	2471.60	N/A	N/A	N/A	N/A
24"(610mm)	60"(1524mm)	66"(1676mm)	WUCP-6066- S 44	\$ 1596.46	\$ 1700.93	\$ 2176.98	\$ 2281.45	N/A	N/A	N/A	N/A
		72"(1829mm)	WUCP-6072- S 44	1808.22	1914.91	2404.98	2511.67	N/A	N/A	N/A	N/A
30"(762mm)	60"(1524mm)	66"(1676mm)	WUCP-6066- S 55	\$ 1633.55	\$ 1741.00	\$ 2214.07	\$ 2321.52	N/A	N/A	N/A	N/A
		72"(1829mm)	WUCP-6072- S 55	1845.31	1954.98	2442.07	2551.74	N/A	N/A	N/A	N/A

Adaptable Worksurfaces — Corner

Angled Corner – 90°

Angled



(Left-hand orientation)



(Right-hand orientation)

WUCU

Angled Transitional

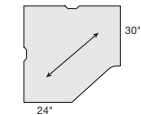
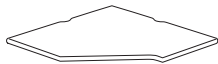

(Left-hand orientation)

WUCF-L45

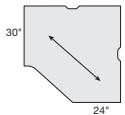

(Right-hand orientation)

WUCF

Class CA

To Order, Specify:

1) Product number, including:

1 Surface Option:

L Laminate

W Wood

2 Edge Option:

Laminate:

J Edgeband

F Knife

Wood:

K Edgeband

U Knife

3 Wireway Option:

A Notched

C Without

4 Orientation (as seated):

(Angled Corner only)

R Right-hand

L Left-hand

2) Laminate color or Wood finish color.

3) Edge trim color (laminite only).

Left/Right Depth	Width	Number	①	②	③	④	HPL Edgeband (J)		HPL Knife Edge (F)		Wood Edgeband (K)		Wood Knife Edge (U)		
							A	B	A	B	A	B	A	B	
Angled															
18"(457mm)	36"(914mm)	WUCU-3636-	S	33	\$ 832.68	\$ 878.20	\$1096.30	\$ 1141.82	\$ 1174.28	\$1239.29	\$ 1507.73	\$ 1572.74			
	42"(1067mm)	WUCU-4242-	S	33	897.91	954.17	1218.23	1274.49	1317.96	1423.08	1724.67	1829.79			
	48"(1219mm)	WUCU-4848-	S	33	1044.43	1111.43	1421.45	1488.45	1542.93	1688.16	2022.90	2168.13			
24"(610mm)	36"(914mm)	WUCU-3636-	S	44	\$ 866.86	\$ 915.10	\$ 1140.98	\$ 1189.22	\$1223.28	\$1294.89	\$ 1544.69	\$ 1616.30			
	42"(1067mm)	WUCU-4242-	S	44	932.09	991.07	1262.91	1321.89	1366.96	1478.68	1761.63	1873.35			
	48"(1219mm)	WUCU-4848-	S	44	1078.61	1148.33	1466.13	1535.85	1591.93	1743.76	2059.86	2211.69			
30"(762mm)	36"(914mm)	WUCU-3636-	S	55	\$ 901.04	\$ 952.00	\$ 1185.66	\$ 1236.62	\$1272.28	\$1350.49	\$ 1581.65	\$1659.86			
	42"(1067mm)	WUCU-4242-	S	55	966.27	1027.97	1307.59	1369.29	1415.96	1534.28	1798.59	1916.91			
	48"(1219mm)	WUCU-4848-	S	55	1112.79	1185.23	1510.81	1583.25	N/A	N/A	N/A	N/A			
	54"(1372mm)	WUCU-5454-	S	55	1259.31	1342.49	1714.03	1797.21	N/A	N/A	N/A	N/A			
Angled Transitional															
18"(457mm)/24"(610mm)	36"(914mm)	WUCF-3636-	S	34	\$ 768.48	\$ 815.36	\$ 1037.35	\$1084.23	\$ 1117.49	\$ 1185.80	\$ 1444.92	\$ 1513.23			
	42"(1067mm)	WUCF-4242-	S	34	915.00	972.62	1240.57	1298.19	1342.46	1450.88	1743.15	1851.57			
	48"(1219mm)	WUCF-4848-	S	34	1061.52	1129.88	1443.79	1512.15	1567.43	1715.96	2041.38	2189.91			
	54"(1372mm)	WUCF-5454-	S	34	1208.04	1287.14	1647.01	1726.11	N/A	N/A	N/A	N/A			
24"(610mm)/18"(457mm)	36"(914mm)	WUCF-3636-	S	43	\$ 768.48	\$ 815.36	\$ 1037.35	\$1084.23	\$ 1117.49	\$ 1185.80	\$ 1444.92	\$ 1513.23			
	42"(1067mm)	WUCF-4242-	S	43	915.00	972.62	1240.57	1298.19	1342.46	1450.88	1743.15	1851.57			
	48"(1219mm)	WUCF-4848-	S	43	1061.52	1129.88	1443.79	1512.15	1567.43	1715.96	2041.38	2189.91			
	54"(1372mm)	WUCF-5454-	S	43	1208.04	1287.14	1647.01	1726.11	N/A	N/A	N/A	N/A			
24"(610mm)/30"(762mm)	36"(914mm)	WUCF-3636-	S	45	\$ 802.66	\$ 852.26	\$1082.03	\$ 1131.63	\$ 1166.49	\$ 1241.40	\$ 1481.88	\$1556.79			
	42"(1067mm)	WUCF-4242-	S	45	949.18	1009.52	1285.25	1345.59	1391.46	1506.48	1780.11	1895.13			
	48"(1219mm)	WUCF-4848-	S	45	1095.70	1166.78	1488.47	1559.55	N/A	N/A	N/A	N/A			
	54"(1372mm)	WUCF-5454-	S	45	1242.22	1324.04	1691.69	1773.51	N/A	N/A	N/A	N/A			
30"(762mm)/24"(610mm)	36"(914mm)	WUCF-3636-	S	54	\$ 802.66	\$ 852.26	\$1082.03	\$ 1131.63	\$ 1166.49	\$ 1241.40	\$ 1481.88	\$1556.79			
	42"(1067mm)	WUCF-4242-	S	54	949.18	1009.52	1285.25	1345.59	1391.46	1506.48	1780.11	1895.13			
	48"(1219mm)	WUCF-4848-	S	54	1095.70	1166.78	1488.47	1559.55	N/A	N/A	N/A	N/A			
	54"(1372mm)	WUCF-5454-	S	54	1242.22	1324.04	1691.69	1773.51	N/A	N/A	N/A	N/A			

Adaptable Worksurfaces — Convergent

General Specifications

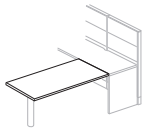

WURV
Rectangular Convergent



WURD
D-Shaped Convergent

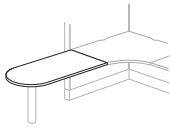

WUDD
D-Shaped Ender
Convergent

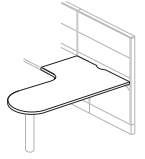

WUCD-L
D-Shaped Convergent,
Wrap-Around

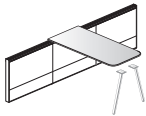

WUYG
Rectangular Radius
Convergent



WUYH
Wedge Radius Convergent



WUYC
Rectangular Radius
Half Convergent

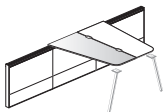

WUYF
Wedge Radius
Half Convergent

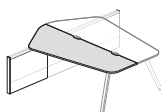

WUYT
Wedge Radius
Half Convergent Plus

Common Features

- Includes worksurface and tie plate.
- Available in high-pressure laminate (HPL) or wood veneer.
- Laminate edge option:
 - [J] 3mm edgeband on user side(s) with 1mm edgeband on sides and back (width).
 - [F] Knife edge on user side(s) and 1mm edgeband on sides and back (width).
- Wood veneer edge option;
 - [K] 3mm edgeband on user side(s) with 1mm edgeband on sides and back (width).
 - [U] Knife edge on user side(s) and 1mm edgeband on sides and back (width).
- Laminate Grade E available on Rectangular worksurfaces only.
- Worksurfaces predrilled to accept most support options. 36" (914mm)W and above are predrilled for pedestals.
- Optional wireway:
 - Wireway will be color-matched to solid side/back edge trim. Wood veneer or patterned/wood grain laminate will have a Charcoal wireway.
 - Refer to Specification Guide for wireway details.
- Optional Belong Hatch cutout:
 - Laminate tops only with one cutout.
 - Available on worksurfaces 30" (762mm), 34" (864mm) and 36" (914mm)D and widths of 60" (1524mm) and 72" (1829mm)
 - Requires separately specified Belong Hatch.
 - Refer to Specification Guide for cutout details.
- **Installed worksurfaces without wireway will not allow clearance for power plug.**
- Depth, width and length shown in nominal dimensions.

Specification Tips

- **Must be attached to a panel or face of a straight worksurface (exception: D-Shaped Ender).**
- **Worksurface support is specific to product line and worksurface edge guidelines; separately specified.**
- Convergent worksurfaces require floor support. Please select one of the following options:
 - Worksurface support post or column
 - Attached lower storage
- Knife edge requires use of worksurface supports for that application; worksurface support panel and/or side bracket for use with knife edge.
- Intermediate support is required for unsupported worksurface span greater than 60" (1524mm).

Note: Separately specified worksurface reinforcement bar provides additional support for worksurfaces with 60" (1524mm) spans that are heavily loaded and not otherwise supported by mid-span cantilevers, worksurface support panels, columns, legs or attached lower storage.

Adaptable Worksurfaces — Convergent Rectangular

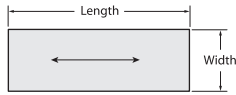
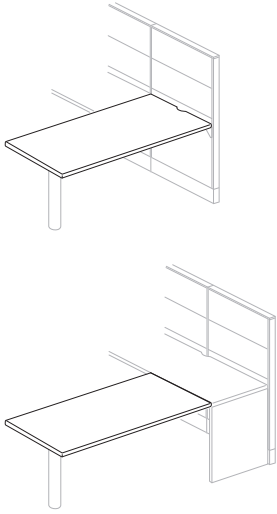

WURV
Class CA

To Order, Specify:

1) Product number, including:

1 Surface Option:

- L** Laminate
- W** Wood

2 Edge Option:

Laminate:

- J** Edgeband
- F** Knife

Wood:

- K** Edgeband
- U** Knife

3 Wireway Option:

- A** Notched
- C** Without

2) Laminate color or Wood finish color.

3) Edge trim color (laminite only).

Width	Length	Number 1 2 3	HPL Edgeband (J)			HPL Knife Edge (F)			Wood Edgeband (K)		Wood Knife Edge (U)	
			A	B	E	A	B	E	A	B	A	B
24"(610mm)	36"(914mm)	WURV-2436- S	\$ 500.66	\$ 530.95	\$ 624.17	\$ 808.73	\$ 839.02	\$ 932.24	\$ 1198.74	\$ 1251.31	\$ 1578.02	\$ 1630.59
	42"(1067mm)	WURV-2442- S	567.47	602.50	710.78	893.19	928.22	1036.50	1298.10	1357.33	1706.08	1765.31
	48"(1219mm)	WURV-2448- S	636.50	677.06	802.91	986.93	1027.49	1153.34	1397.46	1464.46	1845.62	1912.62
	54"(1372mm)	WURV-2454- S	703.31	747.82	886.22	1071.39	1115.90	1254.30	1496.82	1569.37	1973.68	2046.23
	60"(1524mm)	WURV-2460- S	772.34	822.38	978.35	1165.13	1215.17	1371.14	1596.18	1676.50	2113.22	2193.54
	66"(1676mm)	WURV-2466- S	840.26	895.04	1066.07	1254.23	1309.01	1480.04	1695.54	1782.52	2247.02	2334.00
	72"(1829mm)	WURV-2472- S	907.07	965.80	1149.38	1338.69	1397.42	1581.00	1794.90	1887.43	2375.08	2467.61
30"(762mm)	36"(914mm)	WURV-3036- S	\$ 594.13	\$ 624.42	\$ 717.64	\$ 977.53	\$ 1007.82	\$ 1101.04	\$ 1316.66	\$ 1369.23	\$ 1743.28	\$ 1795.85
	42"(1067mm)	WURV-3042- S	658.00	693.03	801.31	1059.05	1094.08	1202.36	1431.38	1490.61	1886.70	1945.93
	48"(1219mm)	WURV-3048- S	724.09	764.65	890.50	1149.85	1190.41	1316.26	1546.10	1613.10	2041.60	2108.60
	54"(1372mm)	WURV-3054- S	787.96	832.47	970.87	1231.37	1275.88	1414.28	1660.82	1733.37	2185.02	2257.57
	60"(1524mm)	WURV-3060- S	854.05	904.09	1060.06	1322.17	1372.21	1528.18	1775.54	1855.86	2339.92	2420.24
	66"(1676mm)	WURV-3066- S	919.03	973.81	1144.84	1408.33	1463.11	1634.14	1890.26	1977.24	2489.08	2576.06
	72"(1829mm)	WURV-3072- S	982.90	1041.63	1225.21	1489.85	1548.58	1732.16	2004.98	2097.51	2632.50	2725.03
36"(914mm)	36"(914mm)	WURV-3636- S	\$ 658.44	\$ 688.73	\$ 781.95	\$ 1071.57	\$ 1101.86	\$ 1195.08	\$ 1401.14	\$ 1453.71	\$ 1837.22	\$ 1889.79
	42"(1067mm)	WURV-3642- S	725.25	760.28	868.56	1156.03	1191.06	1299.34	1567.46	1626.69	2032.24	2091.47
	48"(1219mm)	WURV-3648- S	794.28	834.84	960.69	1249.77	1290.33	1416.18	1733.78	1800.78	2238.74	2305.74
	54"(1372mm)	WURV-3654- S	861.09	905.60	1044.00	1334.23	1378.74	1517.14	1900.10	1972.65	2433.76	2506.31
	60"(1524mm)	WURV-3660- S	930.12	980.16	1136.13	1427.97	1478.01	1633.98	2066.42	2146.74	2640.26	2720.58
	66"(1676mm)	WURV-3666- S	998.04	1052.82	1223.85	1517.07	1571.85	1742.88	2232.74	2319.72	2841.02	2928.00
	72"(1829mm)	WURV-3672- S	1064.85	1123.58	1307.16	1601.53	1660.26	1843.84	2399.06	2491.59	3036.04	3128.57

Adaptable Worksurfaces — Convergent

D-Shape Convergent

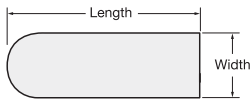
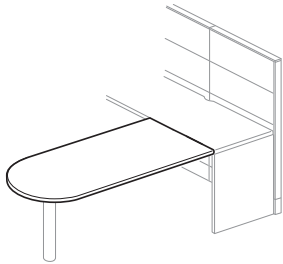
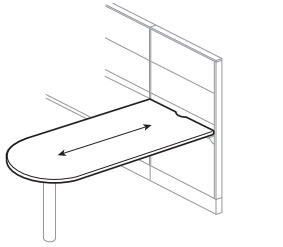

WURD
Class CA

To Order, Specify:

1) Product number, including:

1 Surface Option:

- L** Laminate
- W** Wood

2 Edge Option:

Laminate:

- J** Edgeband
- F** Knife

Wood:

- K** Edgeband
- U** Knife

3 Wireway Option:

- A** Notched
- C** Without

2) Laminate color or Wood finish color.

3) Edge trim color (laminite only).

Width	Length	Number ① ② ③	HPL Edgeband (J)		HPL Knife Edge (F)		Wood Edgeband (K)		Wood Knife Edge (U)	
			A	B	A	B	A	B	A	B
24"(610mm)	36"(914mm)	WURD-2436-■ S ■	\$ 708.24	\$ 739.59	\$ 1149.55	\$ 1180.90	\$ 1348.72	\$ 1403.13	\$ 1743.73	\$ 1798.14
	42"(1067mm)	WURD-2442-■ S ■	777.47	813.74	1237.58	1273.85	1534.30	1598.55	1971.26	2035.51
	48"(1219mm)	WURD-2448-■ S ■	849.00	891.01	1335.43	1377.44	1719.88	1795.61	2215.57	2291.30
	54"(1372mm)	WURD-2454-■ S ■	918.23	964.34	1423.46	1469.57	1905.46	1989.39	2443.10	2527.03
	60"(1524mm)	WURD-2460-■ S ■	989.76	1041.61	1521.31	1573.16	2091.04	2186.45	2687.41	2782.82
	66"(1676mm)	WURD-2466-■ S ■	1060.14	1116.91	1614.25	1671.02	2276.62	2381.87	2923.33	3028.58
	72"(1829mm)	WURD-2472-■ S ■	1129.37	1190.24	1702.28	1763.15	2462.20	2575.65	3150.86	3264.31
30"(762mm)	36"(914mm)	WURD-3036-■ S ■	\$ 773.18	\$ 804.53	\$ 1266.62	\$ 1297.97	\$ 1509.52	\$ 1563.93	\$ 1953.52	\$ 2007.93
	42"(1067mm)	WURD-3042-■ S ■	839.35	875.62	1351.59	1387.86	1697.62	1761.87	2183.57	2247.82
	48"(1219mm)	WURD-3048-■ S ■	907.82	949.83	1446.38	1488.39	1885.72	1961.45	2430.40	2506.13
	54"(1372mm)	WURD-3054-■ S ■	973.99	1020.10	1531.35	1577.46	2073.82	2157.75	2660.45	2744.38
	60"(1524mm)	WURD-3060-■ S ■	1042.46	1094.31	1626.14	1677.99	2261.92	2357.33	2907.28	3002.69
	66"(1676mm)	WURD-3066-■ S ■	1109.78	1166.55	1716.02	1772.79	2450.02	2555.27	3145.72	3250.97
	72"(1829mm)	WURD-3072-■ S ■	1175.95	1236.82	1800.99	1861.86	2638.12	2751.57	3375.77	3489.22
36"(914mm)	36"(914mm)	WURD-3636-■ S ■	\$ 826.04	\$ 857.39	\$ 1324.34	\$ 1355.69	\$ 1573.03	\$ 1627.44	\$ 2026.83	\$ 2081.24
	42"(1067mm)	WURD-3642-■ S ■	895.27	931.54	1412.37	1448.64	1763.65	1827.90	2259.40	2323.65
	48"(1219mm)	WURD-3648-■ S ■	966.80	1008.81	1510.22	1552.23	1954.27	2030.00	2508.75	2584.48
	54"(1372mm)	WURD-3654-■ S ■	1036.03	1082.14	1598.25	1644.36	2144.89	2228.82	2741.32	2825.25
	60"(1524mm)	WURD-3660-■ S ■	1107.56	1159.41	1696.10	1747.95	2335.51	2430.92	2990.67	3086.08
	66"(1676mm)	WURD-3666-■ S ■	1177.94	1234.71	1789.04	1845.81	2526.13	2631.38	3231.63	3336.88
	72"(1829mm)	WURD-3672-■ S ■	1247.17	1308.04	1877.07	1937.94	2716.75	2830.20	3464.20	3577.65

Adaptable Worksurfaces — Convergent

D-Shape Ender Convergent

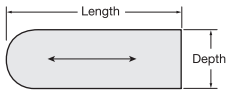
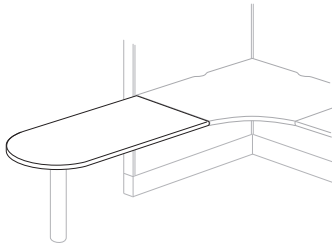

WUDD
Class CA

Unique Specifications

- Must be attached to the depth of adjoining worksurface.

To Order, Specify:

- 1) Product number, including:

① Surface Option:

- L** Laminate
- W** Wood

② Edge Option:

Laminate:

- J** Edgeband
- F** Knife

Wood:

- K** Edgeband
- U** Knife

- 2) Laminate color or Wood finish color.

- 3) Edge trim color (laminite only).

Depth	Length	Number ①②	HPL Edgeband (J)		HPL Knife Edge (F)		Wood Edgeband (K)		Wood Knife Edge (U)	
			A	B	A	B	A	B	A	B
18"(457mm)	36"(914mm)	WUDD-1836- SC	\$ 606.44	\$ 634.92	\$ 828.74	\$ 857.22	\$ 1245.08	\$ 1300.31	\$ 1616.93	\$ 1672.16
	42"(1067mm)	WUDD-1842- SC	662.60	695.76	905.00	938.16	1415.96	1481.15	1837.97	1903.16
	48"(1219mm)	WUDD-1848- SC	718.76	756.60	981.26	1019.10	1586.84	1661.99	2059.01	2134.16
	54"(1372mm)	WUDD-1854- SC	774.92	817.44	1057.52	1100.04	1757.72	1842.83	2280.05	2365.16
	60"(1524mm)	WUDD-1860- SC	831.08	878.28	1133.78	1180.98	1928.60	2023.67	2501.09	2596.16
	66"(1676mm)	WUDD-1866- SC	887.24	939.12	1210.04	1261.92	2099.48	2204.51	2722.13	2827.16
	72"(1829mm)	WUDD-1872- SC	943.40	999.96	1286.30	1342.86	2270.36	2385.35	2943.17	3058.16
24"(610mm)	36"(914mm)	WUDD-2436- SC	\$ 653.70	\$ 682.18	\$ 894.15	\$ 922.63	\$ 1303.69	\$ 1358.92	\$ 1695.47	\$ 1750.70
	42"(1067mm)	WUDD-2442- SC	724.92	758.08	985.47	1018.63	1494.55	1559.74	1936.49	2001.68
	48"(1219mm)	WUDD-2448- SC	796.14	833.98	1076.79	1114.63	1685.41	1760.56	2177.51	2252.66
	54"(1372mm)	WUDD-2454- SC	867.36	909.88	1168.11	1210.63	1876.27	1961.38	2418.53	2503.64
	60"(1524mm)	WUDD-2460- SC	938.58	985.78	1259.43	1306.63	2067.13	2162.20	2659.55	2754.62
	66"(1676mm)	WUDD-2466- SC	1009.80	1061.68	1350.75	1402.63	2257.99	2363.02	2900.57	3005.60
	72"(1829mm)	WUDD-2472- SC	1081.02	1137.58	1442.07	1498.63	2448.85	2563.84	3141.59	3256.58
30"(762mm)	36"(914mm)	WUDD-3036- SC	\$ 717.69	\$ 746.17	\$ 1211.02	\$ 1239.50	\$ 1459.38	\$ 1514.61	\$ 1900.86	\$ 1956.09
	42"(1067mm)	WUDD-3042- SC	785.91	819.07	1299.34	1332.50	1650.24	1715.43	2141.88	2207.07
	48"(1219mm)	WUDD-3048- SC	854.13	891.97	1387.66	1425.50	1841.10	1916.25	2382.90	2458.05
	54"(1372mm)	WUDD-3054- SC	922.35	964.87	1475.98	1518.50	2031.96	2117.07	2623.92	2709.03
	60"(1524mm)	WUDD-3060- SC	990.57	1037.77	1564.30	1611.50	2222.82	2317.89	2864.94	2960.01
	66"(1676mm)	WUDD-3066- SC	1058.79	1110.67	1652.62	1704.50	2413.68	2518.71	3105.96	3210.99
	72"(1829mm)	WUDD-3072- SC	1127.01	1183.57	1740.94	1797.50	2604.54	2719.53	3346.98	3461.97

Adaptable Worksurfaces — Convergent

D-Shape Convergent Wrap-Around

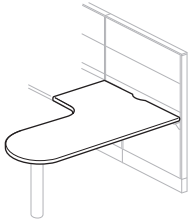

Unique Specifications

- 36"(914mm)W surfaces have a 24"(610mm) diameter D-shaped radius.
- 42"(1067mm)-60"(1524mm)W surfaces have a 30"(762mm) diameter D-shaped radius.
- Mini cantilever brackets are for use with 18"(457mm)D worksurface with knife edge only.

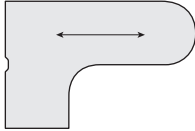

(Right-hand orientation)

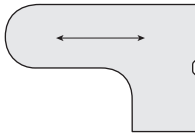

(Left-hand orientation)

WUCD-L
Class CA

To Order, Specify:

1) Product number, including:

1 Surface Option:

- L** Laminate
- W** Wood

2 Edge Option:

Laminate:

- J** Edgeband
- F** Knife

Wood:

- K** Edgeband
- U** Knife

3 Wireway Option:

- A** Notched
- C** Without

4 Orientation (as seated):

- R** Right-hand
- L** Left-hand

2) Laminate color or Wood finish color.

3) Edge trim color (laminite only).

Depth	Width	Length	Number	HPL Edgeband (J)			HPL Knife Edge (F)		Wood Edgeband (K)		Wood Knife Edge (U)		
				1	2	3	4	A	B	A	B	A	B
18"(457mm)	36"(914mm)	60"(1524mm)	WUCD-3660-	S	3	\$ 1387.88	\$ 1487.81	\$ 1755.89	\$ 1855.82	\$ 2328.86	\$ 2499.28	\$ 2810.02	\$ 2980.44
		66"(1676mm)	WUCD-3666-	S	3	1432.82	1535.99	1819.01	1922.18	2412.56	2597.68	2918.20	3103.32
		72"(1829mm)	WUCD-3672-	S	3	1562.72	1669.13	1967.09	2073.50	2581.22	2781.04	3111.34	3311.16
24"(610mm)	36"(914mm)	60"(1524mm)	WUCD-3660-	S	4	\$ 1426.79	\$ 1529.23	\$ 1788.67	\$ 1891.11	\$ 2353.64	\$ 2528.25	\$ 2833.45	\$ 3008.06
		66"(1676mm)	WUCD-3666-	S	4	1471.73	1577.41	1851.79	1957.47	2437.34	2626.65	2941.63	3130.94
		72"(1829mm)	WUCD-3672-	S	4	1601.63	1710.55	1999.87	2108.79	2606.00	2810.01	3134.77	3338.78
30"(762mm)	36"(914mm)	60"(1524mm)	WUCD-3660-	S	5	\$ 1465.70	\$ 1570.65	\$ 1821.45	\$ 1926.40	\$ 2378.42	\$ 2557.22	\$ 2856.88	\$ 3035.68
		66"(1676mm)	WUCD-3666-	S	5	1510.64	1618.83	1884.57	1992.76	2462.12	2655.62	2965.06	3158.56
		72"(1829mm)	WUCD-3672-	S	5	1640.54	1751.97	2032.65	2144.08	2630.78	2838.98	3158.20	3366.40
18"(457mm)	42"(1067mm)	60"(1524mm)	WUCD-4260-	S	3	\$ 1471.73	\$ 1577.41	\$ 1851.79	\$ 1957.47	\$ 2437.34	\$ 2626.65	\$ 2941.63	\$ 3130.94
		66"(1676mm)	WUCD-4266-	S	3	1516.67	1625.59	1914.91	2023.83	2521.04	2725.05	3049.81	3253.82
		72"(1829mm)	WUCD-4272-	S	3	1561.61	1673.77	1978.03	2090.19	2604.74	2823.45	3157.99	3376.70
24"(610mm)	42"(1067mm)	60"(1524mm)	WUCD-4260-	S	4	\$ 1510.64	\$ 1618.83	\$ 1884.57	\$ 1992.76	\$ 2462.12	\$ 2655.62	\$ 2965.06	\$ 3158.56
		66"(1676mm)	WUCD-4266-	S	4	1555.58	1667.01	1947.69	2059.12	2545.82	2754.02	3073.24	3281.44
		72"(1829mm)	WUCD-4272-	S	4	1600.52	1715.19	2010.81	2125.48	2629.52	2852.42	3181.42	3404.32
30"(762mm)	42"(1067mm)	60"(1524mm)	WUCD-4260-	S	5	\$ 1549.55	\$ 1660.25	\$ 1917.35	\$ 2028.05	\$ 2486.90	\$ 2684.59	\$ 2988.49	\$ 3186.18
		66"(1676mm)	WUCD-4266-	S	5	1594.49	1708.43	1980.47	2094.41	2570.60	2782.99	3096.67	3309.06
		72"(1829mm)	WUCD-4272-	S	5	1639.43	1756.61	2043.59	2160.77	2654.30	2881.39	3204.85	3431.94
18"(457mm)	48"(1219mm)	60"(1524mm)	WUCD-4860-	S	3	\$ 1516.67	\$ 1625.59	\$ 1914.91	\$ 2023.83	\$ 2521.04	\$ 2725.05	\$ 3049.81	\$ 3253.82
		66"(1676mm)	WUCD-4866-	S	3	1561.61	1673.77	1978.03	2090.19	2604.74	2823.45	3157.99	3376.70
		72"(1829mm)	WUCD-4872-	S	3	1606.55	1721.95	2041.15	2156.55	2688.44	2921.85	3266.17	3499.58
24"(610mm)	48"(1219mm)	60"(1524mm)	WUCD-4860-	S	4	\$ 1555.58	\$ 1667.01	\$ 1947.69	\$ 2059.12	\$ 2545.82	\$ 2754.02	\$ 3073.24	\$ 3281.44
		66"(1676mm)	WUCD-4866-	S	4	1600.52	1715.19	2010.81	2125.48	2629.52	2852.42	3181.42	3404.32
		72"(1829mm)	WUCD-4872-	S	4	1645.46	1763.37	2073.93	2191.84	2713.22	2950.82	3289.60	3527.20
30"(762mm)	48"(1219mm)	60"(1524mm)	WUCD-4860-	S	5	\$ 1594.49	\$ 1708.43	\$ 1980.47	\$ 2094.41	\$ 2570.60	\$ 2782.99	\$ 3096.67	\$ 3309.06
		66"(1676mm)	WUCD-4866-	S	5	1639.43	1756.61	2043.59	2160.77	2654.30	2881.39	3204.85	3431.94
		72"(1829mm)	WUCD-4872-	S	5	1684.37	1804.79	2106.71	2227.13	2738.00	2979.79	3313.03	3554.82

Adaptable Worksurfaces — Convergent

D-Shape Convergent Wrap-Around

Depth	Width	Length	Number ①② ③④	HPL Edgeband (J)		HPL Knife Edge (F)		Wood Edgeband (K)		Wood Knife Edge (U)	
				A	B	A	B	A	B	A	B
18"(457mm)	54"(1372mm)	60"(1524mm)	WUCD-5460- S 3	\$ 1561.61	\$ 1673.77	\$ 1978.03	\$ 2090.19	N/A	N/A	N/A	N/A
		66"(1676mm)	WUCD-5466- S 3	1606.55	1721.95	2041.15	2156.55	N/A	N/A	N/A	N/A
		72"(1829mm)	WUCD-5472- S 3	1651.49	1770.13	2104.27	2222.91	N/A	N/A	N/A	N/A
24"(610mm)	54"(1372mm)	60"(1524mm)	WUCD-5460- S 4	\$ 1600.52	\$ 1715.19	\$ 2010.81	\$ 2125.48	N/A	N/A	N/A	N/A
		66"(1676mm)	WUCD-5466- S 4	1645.46	1763.37	2073.93	2191.84	N/A	N/A	N/A	N/A
		72"(1829mm)	WUCD-5472- S 4	1690.40	1811.55	2137.05	2258.20	N/A	N/A	N/A	N/A
30"(762mm)	54"(1372mm)	60"(1524mm)	WUCD-5460- S 5	\$ 1639.43	\$ 1756.61	\$ 2043.59	\$ 2160.77	N/A	N/A	N/A	N/A
		66"(1676mm)	WUCD-5466- S 5	1684.37	1804.79	2106.71	2227.13	N/A	N/A	N/A	N/A
		72"(1829mm)	WUCD-5472- S 5	1729.31	1852.97	2169.83	2293.49	N/A	N/A	N/A	N/A
18"(457mm)	60"(1524mm)	60"(1524mm)	WUCD-6060- S 3	\$ 1606.55	\$ 1721.95	\$ 2041.15	\$ 2156.55	N/A	N/A	N/A	N/A
		66"(1676mm)	WUCD-6066- S 3	1651.49	1770.13	2104.27	2222.91	N/A	N/A	N/A	N/A
		72"(1829mm)	WUCD-6072- S 3	1696.43	1818.31	2167.39	2289.27	N/A	N/A	N/A	N/A
24"(610mm)	60"(1524mm)	60"(1524mm)	WUCD-6060- S 4	\$ 1645.46	\$ 1763.37	\$ 2073.93	\$ 2191.84	N/A	N/A	N/A	N/A
		66"(1676mm)	WUCD-6066- S 4	1690.40	1811.55	2137.05	2258.20	N/A	N/A	N/A	N/A
		72"(1829mm)	WUCD-6072- S 4	1735.34	1859.73	2200.17	2324.56	N/A	N/A	N/A	N/A
30"(762mm)	60"(1524mm)	60"(1524mm)	WUCD-6060- S 5	\$ 1684.37	\$ 1804.79	\$ 2106.71	\$ 2227.13	N/A	N/A	N/A	N/A
		66"(1676mm)	WUCD-6066- S 5	1729.31	1852.97	2169.83	2293.49	N/A	N/A	N/A	N/A
		72"(1829mm)	WUCD-6072- S 5	1774.25	1901.15	2232.95	2359.85	N/A	N/A	N/A	N/A

Adaptable Worksurfaces — Convergent

Radius Convergent

Radius Rectangular

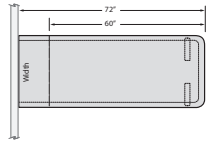
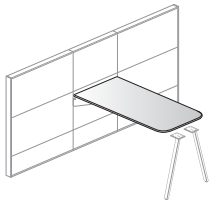
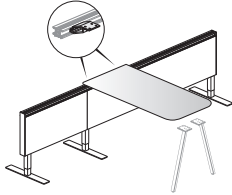

WUYG

Radius Wedge

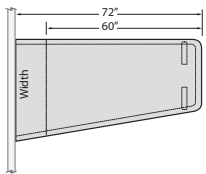
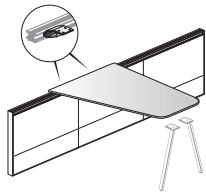

WUYH
Class CA

Unique Specifications

- Flush mount plate is application specific; specify as needed.
- Knife edge option does not allow cantilever bracket attachment on a Rectangular Radius Convergent. Use edgeband option for cantilever attachment.
- Wireway option not available.
- Cantilever bracket not for use on angled side.

To Order, Specify:

1) Product number, including:

1 Surface Option:

L Laminate

W Wood

2 Edge Option:

Laminate:

J Edgeband

F Knife

Wood:

K Edgeband

U Knife

2) Laminate color or Wood finish color.

3) Edge trim color (laminated only).

Left/Right Width	Length	Number ①②	HPL Edgeband (J)			HPL Knife Edge (F)			Wood Edgeband (K)		Wood Knife Edge (U)	
			A	B	E	A	B	E	A	B	A	B
Rectangular												
24" (610mm)	60" (1524mm)	WUYG-2460-SCN	\$1095.06	\$1181.84	\$1477.06	\$1416.74	\$1503.52	\$1798.74	\$2411.48	\$2628.56	\$3037.24	\$3254.32
	72" (1829mm)	WUYG-2472-SCN	1217.38	1313.12	1665.22	1584.90	1680.64	2032.74	2634.04	2888.08	3288.84	3542.88
30" (762mm)	60" (1524mm)	WUYG-3060-SCN	\$1242.38	\$1340.36	\$1706.68	\$1584.34	\$1682.32	\$2048.64	\$2674.80	\$2938.08	\$3315.38	\$3578.66
	72" (1829mm)	WUYG-3072-SCN	1393.42	1502.60	1940.02	1781.22	1890.40	2327.82	2949.28	3258.76	3618.90	3928.38
Wedge												
34" (864mm)/60" (1524mm)	60" (1524mm)	WUYH-3460-SCL	\$1345.62	\$1451.44	\$1867.53	\$1706.14	\$1811.96	\$2228.05	\$2892.66	\$3188.28	\$3550.32	\$3845.94
36" (914mm)/72" (1829mm)	72" (1829mm)	WUYH-3672-SCL	1569.94	1692.56	2215.30	1988.10	2110.72	2633.46	3290.98	3655.90	3989.82	4354.74
60" (1524mm)/34" (864mm)	60" (1524mm)	WUYH-3460-SCR	\$1345.62	\$1451.44	\$1867.53	\$1706.14	\$1811.96	\$2228.05	\$2892.66	\$3188.28	\$3550.32	\$3845.94
72" (1829mm)/36" (914mm)	72" (1829mm)	WUYH-3672-SCR	1569.94	1692.56	2215.30	1988.10	2110.72	2633.46	3290.98	3655.90	3989.82	4354.74

Adaptable Worksurfaces — Convergent

Radius Half Convergent

Rectangular

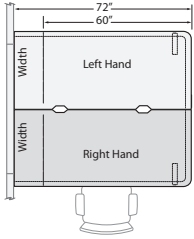
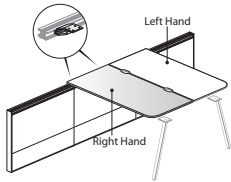

WUYC

Wedge

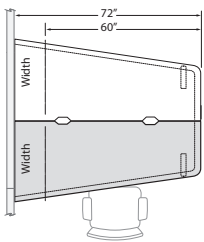
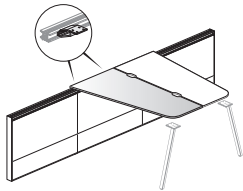

WUYF
Class CA

Unique Specifications

- A left and a right handed work surface must be ordered together.
- A pair of work surfaces requires four separately specified Flush Mount Plates.
- Designed to be used with Belong Plus Screen (SUSC-____-FNZANNN); requires wireway option on both work surfaces.
- 60"(1524mm) tops have two wireways and will only accept 42"(1067mm)W Belong Plus Screen.
- 72"(1829mm) tops have three wireways and will only accept 48"(1219mm)W Belong Plus Screen.
- Cantilever bracket cannot be used with wireway.
- Cantilever bracket not for use on angled side of Wedge Radius Half Convergent.
- Knife edge option for use with 26"(660mm)H frame, Connections or Beam with work rail off modular brackets only.
- Knife edge option does not allow cantilever bracket attachment on a Rectangular Radius Half Convergent. Use edgeband option for cantilever attachment.

To Order, Specify:

1) Product number, including:

1 Surface Option:

- L** Laminate
- W** Wood

2 Edge Option:

Laminate:

- J** Edgeband
- F** Knife

Wood:

- K** Edgeband
- U** Knife

3 Wireway/Cutout Option:

- A** Notched
- C** Without
- H** Belong Hatch

4 Orientation (as seated):

(Rectangular only)

- R** Right-hand
- L** Left-hand

2) Laminate color or Wood finish color.

3) Edge trim color (laminated only).

Left/Right Width	Length	Number	① ② ③ ④	HPL Edgeband (J)			HPL Knife Edge (F)			Wood Edgeband (K)		Wood Knife Edge (U)	
				A	B	E	A	B	E	A	B	A	B
Rectangular													
24"(610mm)	60"(1524mm)	WUYC-2460-	S	\$1140.48	\$1231.33	\$1539.66	\$1455.27	\$1546.12	\$1854.45	\$2298.77	\$2525.47	\$2937.81	\$3164.51
	72"(1829mm)	WUYC-2472-	S	1264.44	1364.81	1732.42	1605.75	1706.12	2073.73	2523.57	2788.75	3178.09	3443.27
30"(762mm)	60"(1524mm)	WUYC-3060-	S	\$1294.32	\$1397.07	\$1779.50	\$1630.41	\$1733.16	\$2115.59	\$2574.01	\$2848.81	\$3228.53	\$3503.33
	72"(1829mm)	WUYC-3072-	S	1448.28	1562.93	2019.46	1810.89	1925.54	2382.07	2853.09	3175.99	3523.09	3845.99
Wedge													
34"(864mm)/24"(610mm)	60"(1524mm)	WUYF-3460-	S L	\$1395.48	\$1506.56	\$1940.86	\$1710.27	\$1821.35	\$2255.65	\$2760.15	\$2760.15	\$3707.66	\$3707.66
36"(914mm)/24"(610mm)	72"(1829mm)	WUYF-3672-	S L	1625.72	1754.65	2300.10	1974.13	2103.06	2648.51	3176.21	3176.21	4216.51	4216.51
24"(610mm)/34"(864mm)	60"(1524mm)	WUYF-3460-	S R	\$1395.48	\$1506.56	\$1940.86	\$1710.27	\$1821.35	\$2255.65	\$2760.15	\$2760.15	\$3707.66	\$3707.66
24"(610mm)/36"(914mm)	72"(1829mm)	WUYF-3672-	S R	1625.72	1754.65	2300.10	1974.13	2103.06	2648.51	3176.21	3556.83	3835.89	4216.51

Adaptable Worksurfaces — Convergent

Wedge Half Convergent Plus

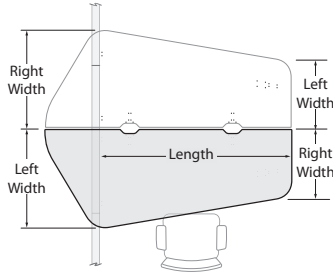
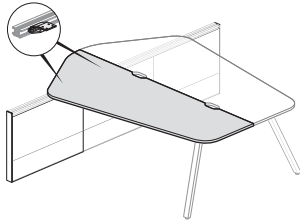

WUYT
Class CA

Unique Specifications

- A left and a right handed work surface must be ordered together.
- A pair of work surfaces requires four separately specified Flush Mount Plates.
- Only for use with 26"(660mm)H frame, Connections, or Beam.
- Designed to be used with Belong Plus Screen (SUSC-___-FNZANNN); requires wireway option on both work surfaces.
- 60"(1524mm) tops have two wireways and will only accept 42"(1067mm)W Belong Plus Screen.
- 72"(1829mm) tops have three wireways and will only accept 48"(1219mm)W Belong Plus Screen.
- Cantilever bracket cannot be used with wireway.
- Cantilever bracket not for use on angled side of Wedge Radius Half Convergent Plus.
- Knife edge option does not allow cantilever bracket attachment on a Rectangular Radius Half Convergent. Use edgeband option for cantilever attachment.

To Order, Specify:

1) Product number, including:

1 Surface Option:

- L** Laminate
- W** Wood

2 Edge Option:

Laminate:

- J** Edgeband
- F** Knife

Wood:

- K** Edgeband
- U** Knife

3 Wireway/Cutout Option:

- A** Notched
- C** Without
- H** Belong Hatch

2) Laminate color or Wood finish color.

3) Edge trim color (laminated only).

Left/Right Width	Length	Number ①②③	HPL Edgeband (J)			HPL Knife Edge (F)			Wood Edgeband (K)		Wood Knife Edge (U)	
			A	B	E	A	B	E	A	B	A	B
34"(864mm)/24"(610mm)	60"(1524mm)	WUYT-3460- [] S L	\$ 1591.66	\$ 1716.52	\$ 2253.48	\$1964.90	\$2089.76	\$ 2626.72	\$3372.15	\$3746.29	\$4029.87	\$4404.01
36"(914mm)/24"(610mm)	72"(1829mm)	WUYT-3672- [] S L	1826.50	1969.28	2620.00	2231.94	2374.72	3025.44	3796.19	4244.25	4473.37	4921.43
24"(610mm)/34"(864mm)	60"(1524mm)	WUYT-3460- [] S R	\$ 1591.66	\$ 1716.52	\$ 2253.48	\$1964.90	\$2089.76	\$ 2626.72	\$3372.15	\$3746.29	\$4029.87	\$4404.01
24"(610mm)/36"(914mm)	72"(1829mm)	WUYT-3672- [] S R	1826.50	1969.28	2620.00	2231.94	2374.72	3025.44	3796.19	4244.25	4473.37	4921.43

Adaptable Worksurfaces — Conference End

Conference End

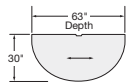
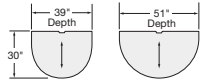

WUDC

Key Conference End

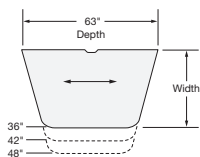
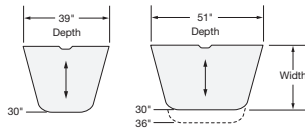
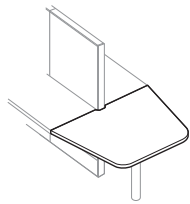

WURY
Class CA

Features

- Includes worksurface and tie plate.
- High-Pressure Laminate (HPL) with 3mm edgeband (J) or knife edge (F) on user edge and 1mm edgeband on back.
- Wood veneer worksurface with 3mm edgeband (K) or knife (U) on user edge and 1mm edgeband on back.
- Worksurfaces predrilled to accept most support options.
- Wireway along back edge is color-matched to solid side/back edge trim.
- When wood veneer or wood grain or patterned laminate is specified, wireway will be Charcoal. Refer to Specification Guide for wireway details.
- Depths and widths shown in nominal dimensions.
- Wireway required to accommodate end-of-run trim.

Specification Tips

- **Worksurface support specific to product line and worksurface edge guidelines; must be separately specified; refer to Specification Guide**
- Key ends with single support posts or columns are generally not considered to be panel supports. See load guidelines in Specification Guide to insure that the panels are properly supported.
- The back edge of the key end must be supported by either
 - Two ZUBF-0000-PN brackets (51"(1295mm)/63"(1600mm) depths)
 - A standard link bracket (pair)
 - Another component with shared worksurface support (Worksurface support panel, P-leg)
 - A combination of the previous three
- **The front of the key end must be supported by one of the following:**
 - **Support post or column - REQUIRED**
- To be used in conference end application.
 - (D) wireway option specific to Compose end-of-run applications

To Order, Specify:

1) Product number, including:

1 Surface Option:

- L** Laminate
- W** Wood

2 Edge Option:

Laminate:

- J** Edgeband
- F** Knife

Wood:

- K** Edgeband
- U** Knife

3 Wireway Option:

- A** Notched
- D** Compose End-of-Run

2) Laminate color or Wood finish color.

3) Edge trim color (laminite only).

Note: Grain direction for Conference and Key Conference End over 63"(1600mm)D will be reversed.

Depth	Width	Number ①②③	HPL Edgeband (J)		HPL Knife Edge (F)		Wood Edgeband (K)		Wood Knife Edge (U)	
			A	B	A	B	A	B	A	B
Conference End										
39"(991mm)	30"(762mm)	WUDC-3930-■ ■ S ■	\$ 955.24	\$ 1021.19	\$1342.32	\$ 1408.27	\$ 2764.31	\$ 2897.87	\$ 3511.02	\$3644.58
51"(1295mm)		WUDC-5130-■ ■ S ■	1000.74	1068.51	1405.37	1473.14	2911.73	3071.55	3700.95	3860.77
63"(1600mm)		WUDC-6330-■ ■ S ■	1042.74	1112.19	1463.57	1533.02	3047.81	3231.87	3876.27	4060.33
Key Conference End										
39"(991mm)	30"(762mm)	WURY-3930-■ ■ S ■	\$1208.49	\$1295.06	\$1698.92	\$ 1785.49	\$3275.63	\$3507.08	\$4258.86	\$ 4490.31
51"(1295mm)	30"(762mm)	WURY-5130-■ ■ S ■	\$ 1215.09	\$ 1302.11	\$1707.83	\$1794.85	\$ 3281.66	\$ 3514.15	\$4264.89	\$ 4497.38
	36"(914mm)	WURY-5136-■ ■ S ■	1241.19	1330.17	1740.90	1829.88	3358.68	3604.98	4364.34	4610.64
63"(1600mm)	36"(914mm)	WURY-6336-■ ■ S ■	\$ 1247.79	\$ 1337.22	\$ 1749.81	\$1839.24	\$ 3364.71	\$ 3612.05	\$4370.37	\$ 4617.71
	42"(1067mm)	WURY-6342-■ ■ S ■	1273.89	1365.28	1782.88	1874.27	3441.73	3702.88	4469.82	4730.97
	48"(1219mm)	WURY-6348-■ ■ S ■	1299.99	1393.34	1815.95	1909.30	3518.75	3793.71	4569.27	4844.23

Adaptable Worksurfaces — 120° Link

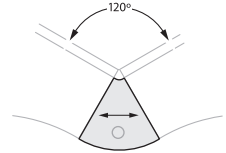
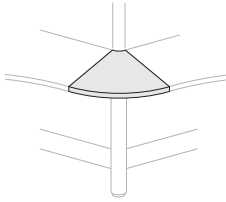

WZDZ
Class CA

Features

- Includes work surface and tie plate.
- High-Pressure Laminate (HPL) with 3mm edgeband (J) or knife edge (F) on user edge and 1mm edgeband on sides and back.
- Wood veneer work surface with 3mm edgeband (K) or knife (U) on user edge and 1mm edgeband on back.
- Worksurfaces predrilled to accept most support options.
- Depth shown in nominal dimensions.

Specification Tips

- Support column, leg or work surface support panel may be used dependent upon application.
- Use with Corner, 120° Wrap-Around worksurfaces.
- **Work surface support specific to product line and work surface edge guidelines; must be separately specified; refer to Specification Guide for support and load.**
 - P-Leg
 - Support post
 - Support column
 - Work surface support panel
 - Tie plate with 18"(457mm) depth
 - Flush mount plates with 24"(610mm) and 30"(762mm) depths
 - Standard link cantilevers
- Knife edge requires use of work surface supports for that application; work surface support panel and/or side bracket for use with knife edge.
- Mini cantilever brackets are for use with 18"(457mm)D work surfaces with knife edge only.

To Order, Specify:

1) Product number, including:

1 Surface Option:

- L** Laminate
- W** Wood

2 Edge Option:

Laminate:

- J** Edgeband
- F** Knife

Wood:

- K** Edgeband
- U** Knife

2) Laminate color or Wood finish color.

3) Edge trim color (laminated only).

Depth	Number 12	SC	HPL Edgeband (J)		HPL Knife Edge (F)		Wood Edgeband (K)		Wood Knife Edge (U)	
			A	B	A	B	A	B	A	B
18"(457mm)	WZDZ-1821-	SC	\$462.92	\$496.50	\$ 712.65	\$ 746.23	\$1243.83	\$ 1348.09	\$ 1670.75	\$ 1775.01
24"(610mm)	WZDZ-2427-	SC	507.76	541.34	757.49	791.07	1382.35	1451.22	1809.27	1878.14
30"(762mm)	WZDZ-3033-	SC	717.36	770.37	1047.51	1100.52	1929.36	2058.34	2539.96	2668.94

Adaptable Worksurfaces — Triangular Key

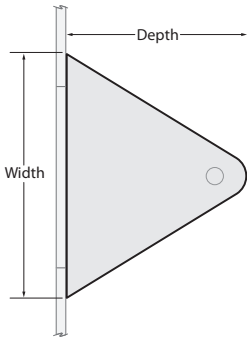
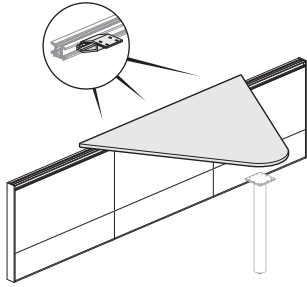

WUYP
Class CA

Features

- Includes worksurface.
- High-Pressure Laminate (HPL) with 3mm edgeband (J) or knife edge (F) on user edge and 1mm edgeband on panel sides and back.
- Wood with 3mm edgeband (K) or knife edge (U) on user edge and 1mm edgeband on panel sides and back.
- Edge detail is on all sides except the panel and worksurface attachment location.
- Depths and widths shown in nominal dimensions.

Specification Tips

- **Worksurface support specific to product line and worksurface edge guidelines; must be separately specified; refer to Specification Guide.**
- Designed to be used with Off Modular Bracket and work rail or side corner bracket.
- Not for use with cantilevers.
- Worksurface support must be separately specified.

To Order, Specify:

1) Product number, including:

1 Surface Option:

- L** Laminate
- W** Wood

2 Edge Option:

Laminate:

- J** Edgeband
- F** Knife

Wood:

- K** Edgeband
- U** Knife

2) Laminate color or Wood finish color.

3) Edge trim color (laminite only).

Depth	Width	Number ①②	HPL Edgeband (J)		HPL Knife Edge (F)		Wood Edgeband (K)		Wood Knife Edge (U)	
			A	B	A	B	A	B	A	B
48"(1219mm)	60"(1524mm)	WUYP-4860-■ ■ SC	\$1350.52	\$1457.45	\$ 1638.79	\$1745.72	\$2893.57	\$3226.59	\$ 3517.13	\$3850.15
60"(1524mm)	72"(1829mm)	WUYP-6072-■ ■ SC	\$1692.61	\$ 1825.14	\$2035.02	\$2167.55	\$ 3721.26	\$ 4199.08	\$4384.01	\$4861.83

Adaptable Worksurfaces — Rectangular Key

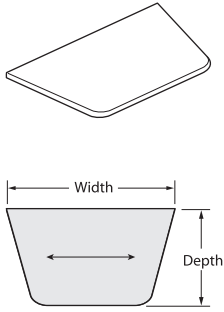

WURY
Class CA

Features

- Includes worksurface and tie plate.
- High-Pressure Laminate (HPL) with 3mm edgeband (J) or knife edge (F) on user edge and 1mm edgeband on sides and back.
- Wood veneer surface with 3mm edgeband (K) or knife (U) on user edge and 1mm edgeband on sides and back.
- **Worksurface width dimension attaches directly to panel and matches panel width.**
- Worksurfaces predrilled to accept most support options.
- Optional wireway can be specified to accommodate panel end-of-run trim. Wireway is color-matched to solid side/edge trim. When wood veneer or wood grain or patterned laminate is specified, wireway will be Charcoal. Refer to Specification Guide for wireway details.
- **Installed worksurfaces without wireway will not allow clearance for power plug.**
- Depths and widths shown in nominal dimensions.

Specification Tips

- **Worksurface support specific to product line and worksurface edge guidelines; must be separately specified; refer to Specification Guide for support and load.**
- Knife edge requires use of worksurface supports for that application; worksurface support panel and/or side bracket for use with knife edge.
- **Support post or column is required.**

To Order, Specify:

1) Product number, including:

1 Surface Option:

- L** Laminate
- W** Wood

2 Edge Option:

Laminate:

- J** Edgeband
- F** Knife

Wood:

- K** Edgeband
- U** Knife

3 Wireway/Cutout Option:

- A** Notched
- C** Without

2) Laminate color or Wood finish color.

3) Edge trim color (laminite only).

Width	Length	Number ①② ③	HPL Edgeband (J)			HPL Knife Edge (F)			Wood Edgeband (K)		Wood Knife Edge (U)	
			A	B	E	A	B	E	A	B	A	B
30"(762mm)	36"(914mm)	WURY-3036- [] S []	\$ 982.83	\$1054.92	\$ 1272.93	\$1393.07	\$ 1465.16	\$ 1683.17	\$ 2681.21	\$ 2841.21	\$ 3571.09	\$ 3731.09
	48"(1219mm)	WURY-3048- [] S []	1044.70	1121.02	1365.47	1476.75	1553.07	1797.52	2824.49	3010.01	3756.04	3941.56
36"(914mm)	48"(1219mm)	WURY-3648- [] S []	\$ 1108.70	\$ 1189.58	\$1462.83	\$1560.96	\$ 1641.84	\$ 1915.09	\$2990.64	\$3205.71	\$ 3968.77	\$ 4183.84
	60"(1524mm)	WURY-3660- [] S []	1170.57	1255.68	1555.37	1644.64	1729.75	2029.44	3133.92	3374.51	4153.72	4394.31
	72"(1829mm)	WURY-3672- [] S []	1232.44	1321.78	1647.91	1728.32	1817.66	2143.79	3277.20	3543.31	4338.67	4604.78
42"(1067mm)	60"(1524mm)	WURY-4260- [] S []	\$ 1234.57	\$ 1324.24	\$ 1652.73	\$ 1728.85	\$ 1818.52	\$ 2147.01	\$3300.07	\$3570.21	\$4366.45	\$4636.59
	72"(1829mm)	WURY-4272- [] S []	1296.44	1390.34	1745.27	1812.53	1906.43	2261.36	3443.35	3739.01	4551.40	4847.06
48"(1219mm)	60"(1524mm)	WURY-4860- [] S []	\$ 1298.57	\$ 1392.80	\$ 1750.09	\$ 1813.06	\$ 1907.29	\$ 2264.58	\$ 3466.22	\$ 3765.91	\$ 4579.18	\$ 4878.87
	72"(1829mm)	WURY-4872- [] S []	1360.44	1458.90	1842.63	1896.74	1995.20	2378.93	3609.50	3934.71	4764.13	5089.34

Adaptable Worksurfaces

Countertop

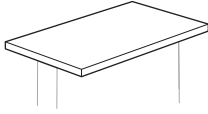

WUTS
Class CA

Features

- Includes countertop and tie plate.
- High-Pressure Laminate (HPL) with 3mm edgeband (J) or knife edge (F) on user edge and 1mm edgeband on ends.
- Wood veneer surface with 3mm edgeband (K) or knife (U) on user edges and 1mm edgeband on ends.
- Depths and widths shown in nominal dimensions.

Specification Tips

- For use in applications that match panel width or multiple panel widths.
- **Countertop support specific to product line; must be separately specified.**

To Order, Specify:

1) Product number, including:

1 Surface Option:

- L** Laminate
- W** Wood

2 Edge Option:

Laminate:

- J** Edgeband
- F** Knife

Wood:

- K** Edgeband
- U** Knife

2) Laminate color or Wood finish color.

3) Edge trim color (laminite only).

Width	Length	Number ①②	HPL Edgeband (J)		HPL Knife Edge (F)		Wood Edgeband (K)		Wood Knife Edge (U)	
			A	B	A	B	A	B	A	B
12"(305mm)	23"(584mm)	WUTS-1223- SC	\$498.28	\$534.83	\$ 942.10	\$ 978.65	\$ 872.05	\$ 905.00	\$ 1329.46	\$ 1362.41
	24"(610mm)	WUTS-1224- SC	502.64	539.50	947.99	984.85	879.24	913.45	1338.60	1372.81
	29"(737mm)	WUTS-1229- SC	524.44	562.85	977.44	1015.85	915.19	955.70	1384.30	1424.81
	30"(762mm)	WUTS-1230- SC	528.80	567.52	983.33	1022.05	922.38	964.15	1393.44	1435.21
	35"(889mm)	WUTS-1235- SC	550.60	590.87	1012.78	1053.05	958.33	1006.40	1439.14	1487.21
	36"(914mm)	WUTS-1236- SC	554.96	595.54	1018.67	1059.25	965.52	1014.85	1448.28	1497.61
	41"(1041mm)	WUTS-1241- SC	576.76	618.89	1048.12	1090.25	1001.47	1057.10	1493.98	1549.61
	42"(1067mm)	WUTS-1242- SC	581.12	623.56	1054.01	1096.45	1008.66	1065.55	1503.12	1560.01
	47"(1194mm)	WUTS-1247- SC	602.92	646.91	1083.46	1127.45	1044.61	1107.80	1548.82	1612.01
	48"(1219mm)	WUTS-1248- SC	607.28	651.58	1089.35	1133.65	1051.80	1116.25	1557.96	1622.41
	53"(1346mm)	WUTS-1253- SC	629.08	674.93	1118.80	1164.65	1087.75	1158.50	1603.66	1674.41
	54"(1372mm)	WUTS-1254- SC	633.44	679.60	1124.69	1170.85	1094.94	1166.95	1612.80	1684.81
	59"(1499mm)	WUTS-1259- SC	655.24	702.95	1154.14	1201.85	1130.89	1209.20	1658.50	1736.81
	60"(1524mm)	WUTS-1260- SC	659.60	707.62	1160.03	1208.05	1138.08	1217.65	1667.64	1747.21
	65"(1651mm)	WUTS-1265- SC	681.40	730.97	1189.48	1239.05	1174.03	1259.90	1713.34	1799.21
	66"(1676mm)	WUTS-1266- SC	685.76	735.64	1195.37	1245.25	1181.22	1268.35	1722.48	1809.61
	71"(1803mm)	WUTS-1271- SC	707.56	758.99	1224.82	1276.25	1217.17	1310.60	1768.18	1861.61
	72"(1829mm)	WUTS-1272- SC	711.92	763.66	1230.71	1282.45	1224.36	1319.05	1777.32	1872.01
	77"(1956mm)	WUTS-1277- SC	733.72	787.01	1260.16	1313.45	1260.31	1361.30	1823.02	1924.01
	78"(1981mm)	WUTS-1278- SC	738.08	791.68	1266.05	1319.65	1267.50	1369.75	1832.16	1934.41
83"(2108mm)	WUTS-1283- SC	759.88	815.03	1295.50	1350.65	1303.45	1412.00	1877.86	1986.41	
84"(2134mm)	WUTS-1284- SC	764.24	819.70	1301.39	1356.85	1310.64	1420.45	1887.00	1996.81	
89"(2261mm)	WUTS-1289- SC	786.04	843.05	1330.84	1387.85	1346.59	1462.70	1932.70	2048.81	
90"(2286mm)	WUTS-1290- SC	790.40	847.72	1336.73	1394.05	1353.78	1471.15	1941.84	2059.21	
95"(2413mm)	WUTS-1295- SC	812.20	871.07	1366.18	1425.05	1389.73	1513.40	1987.54	2111.21	
96"(2438mm)	WUTS-1296- SC	816.56	875.74	1372.07	1431.25	1396.92	1521.85	1996.68	2121.61	
101"(2565mm)	WUTS-12A1- SC	838.36	899.09	1401.52	1462.25	1432.87	1564.10	2042.38	2173.61	
102"(2591mm)	WUTS-12A2- SC	842.72	903.76	1407.41	1468.45	1440.06	1572.55	2051.52	2184.01	
107"(2718mm)	WUTS-12A7- SC	864.52	927.11	1436.86	1499.45	1476.01	1614.80	2097.22	2236.01	
108"(2743mm)	WUTS-12A8- SC	868.88	931.78	1442.75	1505.65	1483.20	1623.25	2106.36	2246.41	
113"(2870mm)	WUTS-12B3- SC	890.68	955.13	1472.20	1536.65	1519.15	1665.50	2152.06	2298.41	
114"(2896mm)	WUTS-12B4- SC	895.04	959.80	1478.09	1542.85	1526.34	1673.95	2161.20	2308.81	
119"(3023mm)	WUTS-12B9- SC	916.84	983.15	1507.54	1573.85	1562.29	1716.20	2206.90	2360.81	
120"(3048mm)	WUTS-12C0- SC	921.20	987.82	1513.43	1580.05	1569.48	1724.65	2216.04	2371.21	

Adaptable Worksurfaces — Adjustable Split Top

Rectangular

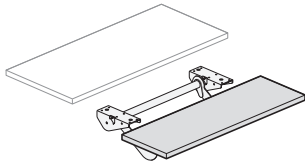

WUKR
Class CA

Features

- Includes one split rectangular split top surface with spring assist mechanism and hardware.
- Available in high-pressure laminate (HPL) only with 3mm edgeband on user edge and 1mm edgeband on sides and back.
- Spring assist mechanism:
 - Available in charcoal finish color only.
 - Spring assisted adjustment with manual lock.
 - Adjusts 6”(152mm) above and 6”(152mm) below worksurface.

Specification Tips

- For use with 18”(457mm)D adaptable worksurfaces (WURA); separately specified.
- May be used with same width worksurface or larger.
- Overall depth of worksurface with split top is 30”(762mm).
- Rectangular worksurface split top applications are designed to align with adjacent 30”(762mm)D worksurfaces.
- Split top is designed to allow pinch point clearance to accommodate cables.
- Not designed for use on worksurfaces with knife edge.
- Not for use with attached pedestals.

To Order, Specify:

- 1) Product number.
- 2) Laminate color.
- 3) Edgeband color.

Depth	Width	Minimum Worksurface Width	Number	HPL A	B
12”(305mm)	34”(864mm)	36”(914mm)	WUKR-1236-LJSC	\$2227.29	\$2591.67
	40”(1016mm)	42”(1067mm)	WUKR-1242-LJSC	2374.79	2763.33
	46”(1168mm)	48”(1219mm)	WUKR-1248-LJSC	2522.29	2934.99

Corner — 90°

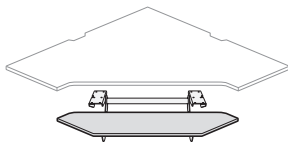

WUKC
Class CA

Features

- Includes one 90° corner split top surface with spring assist mechanism and hardware.
- Available in high-pressure laminate (HPL) only with 3mm edgeband on user edge and 1mm edgeband on sides and back.
- Spring assist mechanism:
 - Available in charcoal finish color only.
 - Spring assisted adjustment with manual lock.
 - Adjusts 6”(152mm) above and 6”(152mm) below worksurface.

Specification Tips

- For use with 18”(457mm)D x 48”(1219mm)W Corner — 90° worksurfaces (WUCN); separately specified.
- Overall depth of worksurface with split top is 30”(762mm).
- Corner worksurface split top applications are designed to align with adjacent 18”(457mm)D worksurfaces.
- Split top is designed to allow pinch point clearance to accommodate cables.
- Not designed for use with adjacent worksurfaces 24”(610mm) or 30”(762mm)D.
- Not designed for use on worksurfaces with knife edge.
- Not for use with attached pedestals.

To Order, Specify:

- 1) Product number.
- 2) Laminate color.
- 3) Edgeband color.

Depth	Width	Number	HPL A	B
12”(305mm)	48”(1219mm)	WUKC-1248-LJSC	\$2374.79	\$2763.33

Worksurface Support

Worksurface Support Panels

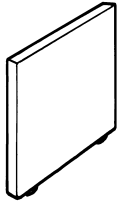

Edgeband



Knife

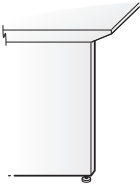

ZZFS
ZUFS
Class CA

Features

- Includes support panel with glides and mounting hardware.
- Installs in panel frame component slots and attaches under the end of a worksurface.
- Provides full support for one end of equal depth worksurfaces.
- Recommended in heavy loading conditions.
- Non-handed design may be installed in left-hand, right-hand or shared configuration.
- High-Pressure Laminate (HPL) or wood surfaces with 1mm edgeband.
- Adjustable glides provide a maximum of 2.5"(64mm) of height adjustment.

Specification Tips

- Specify worksurface support panel to match worksurface edge option.
- Separately specify Anti-Dislodgement Bracket for additional support. Please refer to Anti-Dislodgement Bracket price list page for specification tips.

To Order, Specify:

1) Product number, including:

1 Surface Options:

L Laminate

W Wood

2 Edge Options:

Laminate:

J Edgeband

F Knife

Wood:

K Edgeband

U Knife

2) Laminate color or Wood finish color.

3) Edge trim color (laminite only).

Height	Thickness	Depth	Number ① ②	HPL		Wood	
				A	B	A	B
27.875"(708mm)	1.18"(30mm)	12"(305mm)	ZZFS-1200-■ NE ■	\$ 445.62	\$ 482.93	\$ 791.83	\$ 868.17
		18"(457mm)	ZZFS-1800-■ NE ■	482.94	517.49	839.77	922.59
		24"(610mm)	ZZFS-2400-■ NE ■	520.26	552.05	887.71	977.01
		30"(762mm)	ZZFS-3000-■ NE ■	557.58	586.61	935.65	1031.43
23.5"(597mm)	1.5"(38mm)	18"(457mm)	ZUFS-1924-LNFJS	\$ 284.51	\$ 397.52	N/A	N/A
27"(686mm)		18"(457mm)	ZUFS-1927-LNFJS	\$ 320.84	\$ 433.85	N/A	N/A
		24"(610mm)	ZUFS-2427-LNFJS	361.24	474.25	N/A	N/A
		30"(762mm)	ZUFS-3027-LNFJS	409.72	522.73	N/A	N/A
		36"(914mm)	ZUFS-3627-LNFJS	458.20	571.21	N/A	N/A
28"(711mm)	1.5"(38mm)	18"(457mm)	ZUFS-1928-LNFJS	\$ 332.95	\$ 445.96	N/A	N/A
		24"(610mm)	ZUFS-2428-LNFJS	373.35	486.36	N/A	N/A
		30"(762mm)	ZUFS-3028-LNFJS	421.83	534.84	N/A	N/A
		36"(914mm)	ZUFS-3628-LNFJS	470.31	583.32	N/A	N/A
23.5"(597mm)	2"(51mm)	18"(457mm)	ZUFS-1924-LNFJM	\$ 470.14	\$ 583.15	N/A	N/A
27"(686mm)		18"(457mm)	ZUFS-1927-LNFJM	\$ 530.71	\$ 643.72	N/A	N/A
		24"(610mm)	ZUFS-2427-LNFJM	581.21	694.22	N/A	N/A
		30"(762mm)	ZUFS-3027-LNFJM	641.81	754.82	N/A	N/A
		36"(914mm)	ZUFS-3627-LNFJM	702.41	815.42	N/A	N/A
28"(711mm)	2"(51mm)	18"(457mm)	ZUFS-1928-LNFJM	\$ 550.90	\$ 663.91	N/A	N/A
		24"(610mm)	ZUFS-2428-LNFJM	601.40	714.41	N/A	N/A
		30"(762mm)	ZUFS-3028-LNFJM	662.00	775.01	N/A	N/A
		36"(914mm)	ZUFS-3628-LNFJM	722.60	835.61	N/A	N/A

Worksurface Support

Worksurface Support Panels

Anti Dislodgement Bracket for use with Worksurface Support Panels

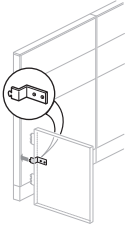

ZZBF-0000-P
Class CA

Features

- Includes one left or right-hand shared or non-shared anti-dislodgement bracket and mounting screws.
- Standard in black finish only.

Specification Tips

- **Anti-Dislodgement Bracket only for use with worksurface support panels used in conjunction with a worksurface.**
- Worksurface support panel with anti-dislodgement bracket can be used in place of a return panel in some applications.
- Panel runs with worksurface support panels: minimum of one anti-dislodgement bracket needed per side.
- See Load and Support guidelines for details.

To Order, Specify:

1) Product number, including:

1 Handedness:

R Right

L Left

(No finish specification required.)

Height	Description	For use with	Number 1	Price
0.9" (23mm)	Non-shared	End condition	ZZBF-0000-P <input type="checkbox"/>	\$150.92
	Shared	Panel seams	ZZBF-0000-P <input type="checkbox"/> S	\$150.92

Worksurface Support

Standard Cantilever Bracket

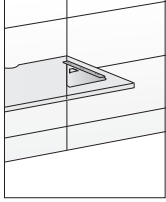

ZZBD
Class CA

Features

- Includes one right- and/or one left-handed bracket and mounting screws.
- Provides cantilever support for the left or right side of worksurface.
- Installs in panel side trim rail.
- Cantilever bracket can be used on either a 18"(457mm), 24"(610mm) or 30"(762mm)D worksurface.
- Mounts worksurface in one inch vertical increments from a minimum of 17"(432mm)H.
- Provides clear access leg swing when supporting 24"(610mm) and 30"(762mm)D worksurfaces at standard 29"(737mm)H.
- (P) finish option standard in black

To Order, Specify:

- 1) Product number, including:
 - ❶ **Finish Option:**
 - P** No finish specification required.
 - C** Painted.
- 2) Trim color (Option C).

Height	Depth	Width	Description	Number	Black (P)	Painted (C)	
					Price	Trim A	Trim B
9"(229mm)	1.625"(41mm)	16"(406mm)	Right-hand	ZZBD-1600- R	\$99.33	\$ 127.37	\$ 131.19
			Left-hand	ZZBD-1600- L	99.33	127.37	131.19
			Pair	ZZBD-1600- P	163.14	240.24	251.67

Standard Mini Cantilever Bracket

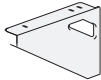

ZZBD-1000
Class CA

Features

- Includes one right- and/or one left-handed bracket and mounting screws.
- Installs in panel side trim rail.
- Mounts worksurface in one inch vertical increments from a minimum of 17"(432mm)H.
- (P) finish option standard in black.

Specification Tip

- **Mini cantilever brackets are for use with 18"(457mm)D worksurfaces with knife edge only.**

To Order, Specify:

- 1) Product number, including:
 - ❶ **Finish Option:**
 - P** No finish specification required.
 - C** Painted
- 2) Trim color (Option C).

Height	Depth	Width	Description	Number	Black (P)	Painted (C)	
					Price	Trim A	Trim B
9"(229mm)	1.625"(41mm)	10"(254mm)	Right-hand	ZZBD-1000- R	\$ 111.31	\$139.35	\$ 143.17
			Left-hand	ZZBD-1000- L	111.31	139.35	143.17
			Pair	ZZBD-1000- P	184.08	261.18	272.61

Connections Cantilever Bracket

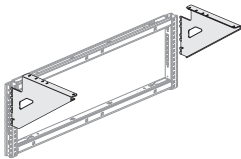

ZZBD
Class BC

Features

- Includes one right- and/or one left-handed bracket and attachment hardware.
- Provides cantilever support for the left or right side of worksurface.
- **Installs in Connections or 26"(660mm)H frame rail.**
- Cantilever bracket for use with Adaptable Worksurfaces.
- Provides clear access leg swing when supporting 24"(610mm) and 30"(762mm)D worksurfaces at standard height.

Specification Tips

- Right and Left-hand cantilevers can be installed side-by-side between worksurfaces in an in-line condition.
- Mounts underside of worksurface in one inch vertical increments from 21"(533mm)-28"(711mm).
- For use with Work Rail, Aluminum or Steel top trim.
- Not for use with Compose Beam.

To Order, Specify:

- 1) Product number.
- 2) Trim color.

Height	Depth	Width	Description	Number	Trim	
					A	B
9"(229mm)	1.625"(41mm)	16"(406mm)	Right-hand	ZZBD-1600-CRNB	\$ 216.14	\$246.88
			Left-hand	ZZBD-1600-CLNB	216.14	246.88
			Pair	ZZBD-1600-CPNB	432.28	463.02

Worksurface Support

Beam Cantilever Bracket

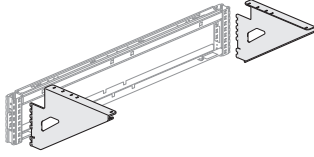

ZZBD
Class BC

Features

- Includes one right- and/or one left-handed bracket and attachment hardware.
- Provides cantilever support for the left or right side of worksurface.
- Installs in Beam Frame rail.
- Cantilever bracket for use with Adaptable Worksurfaces.
- Provides clear access leg swing when supporting 24"(610mm) and 30"(762mm)D worksurfaces at standard height.

Specification Tips

- Right and Left-hand cantilevers can be installed side-by-side between worksurfaces in an in-line condition.
- Mounts underside of worksurface 28"(711mm) from the floor.
- Cantilever cannot be mounted under knife edge surfaces.
- For use with all trim options.
- For use with Compose Beam only.

To Order, Specify:

- 1) Product number.
- 2) Trim color.

Height	Depth	Width	Description	Number	Trim	
					A	B
9"(229mm)	1.625"(41mm)	16"(406mm)	Right-hand	ZZBD-0800-CRNJ	\$ 216.14	\$246.88
			Left-hand	ZZBD-0800-CLNJ	216.14	246.88
			Pair	ZZBD-0800-CPNJ	432.28	463.02

Gallery Panel Cantilever Bracket

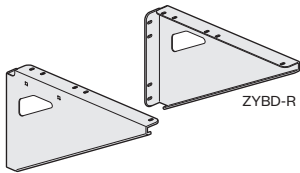

ZYBD-L
ZYBD-1800
Class BCX

Features

- Includes one right-handed or one left-handed bracket and mounting screws to the Gallery panel and for a worksurface.
- Provides cantilever support for the left, right or middle of worksurface.
- Cantilever bracket can be used on either a 18"(457mm), 24"(610mm) or 30"(762mm)D worksurface.
- (P) finish option standard in black.
- Field installed.

Specification Tips

- Cantilevers are not to be the sole support for a worksurface. See Specification Guide/Product Application for support and load guidelines.
- Designed for use with Gallery Panels.
- For structural wall mount see Specification Guide/Product Application for support and load guidelines.

To Order, Specify:

- 1) Product number, including:
 - ① **Finish Option**
 - P** No finish specification required.
 - C** Painted.
- 2) Trim color (Option C).

Height	Depth	Width	Description	Number ①	Black (P)	Painted (C)	
					Price	Trim A	B
9"(229mm)	1.625"(41mm)	16"(406mm)	Right-hand	ZYBD-1600-█ R	\$106.17	\$134.21	\$138.03
			Left-hand	ZYBD-1600-█ L	106.17	134.21	138.03

Worksurface Support

Standard Link Cantilever Bracket

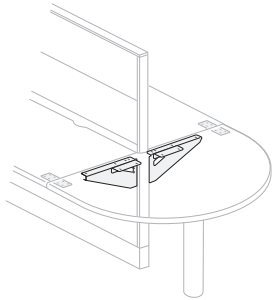

ZZBL-1600
Class CA

Features

- Includes one right- and/or one left-handed bracket, with attached angle bracket and mounting screws.
- Provides cantilever support for the left or right side of conference end and key conference end and the adjoining worksurface.
- Installs in panel side trim rail.
- Cantilever bracket can be used on either a 18"(457mm), 24"(610mm) or 30"(762mm)D worksurface.
- Mounts worksurface in one inch vertical increments from a minimum of 17"(432mm)H.
- Provides clear access leg swing when supporting 24"(610mm) and 30"(762mm)D worksurfaces at standard 29"(737mm)H.
- (P) finish option standard in black.

Specification Tip

- **To be used with conference end, key conference end, 120° link and D-shaped ender only.**

To Order, Specify:

1) Product number.

1 Finish Option:

- P** No finish specification required.
- C** Painted.

2) Trim color (Option C).

Height	Depth	Width	Description	Number	Black (P)	Painted (C) Trim	
					Price	A	B
9"(229mm)	16.5"(419mm)	3.75"(95mm)	Right-hand	ZZBL-1600- R	\$ 143.37	\$ 171.41	\$ 175.23
			Left-hand	ZZBL-1600- L	143.37	171.41	175.23
			Pair	ZZBL-1600- P	240.22	317.32	328.75

Side/Corner Bracket — Full Panel

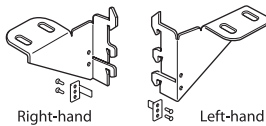

ZZBA-0000-PR
ZZBA-0000-PL
Class CA

Features

- Includes one left- or right-hand bracket, mounting screws and dislodgement clip.
- Standard in black finish color only
- Installs into full panel side trim rail and attaches to worksurface.
- Not for use with front corner of worksurfaces with knife edge.

To Order, Specify:

1) Product number. (No finish specification required.)

Description	Number	Price
Right-hand	ZZBA-0000-PR	\$30.94
Left-hand	ZZBA-0000-PL	30.94

Side/Corner Bracket for use with Knife Edge — Full Panel

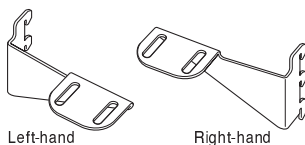

ZZBA-0000-PRF
ZZBA-0000-PLF
Class CA

Features

- Includes one left- or right-hand bracket, mounting screws.
- Attaches to front corner of worksurface with knife edge.

To Order, Specify:

1) Product number.
2) Trim color.

Description	Number	Trim	
		A	B
Right	ZZBA-0000-PRF	\$91.41	\$116.01
Left	ZZBA-0000-PLF	91.41	116.01

Worksurface Support

Side/Corner Bracket — 26" (660mm)H, Connections or Beam

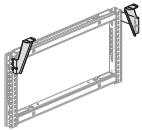

ZZBA
Class BC

Features

- Includes one right- or left-hand bracket, attachment hardware and dislodgement clip.
- **Installs in 26" (660mm)H panel frame, Connections or Beam frame rail.**
- For use with worksurfaces with or without knife edge.

Specification Tips

- Required for use with 26" (660mm)H panel frame.
- Mounts underside of worksurface in one inch vertical increments from 21" (533mm)-28" (711mm).
- For use with Work Rail, Aluminum or Steel top trim.
- Required for back corner support with corner, 120° Wrap-Around worksurface.

To Order, Specify:

- 1) Product number.
- 2) Trim color.

Description	Number	Trim	
		A	B
Right-hand	ZZBA-0000-CRJB	\$88.45	\$111.54
Left-hand	ZZBA-0000-CLJB	88.45	111.54

Flush Mount Plate

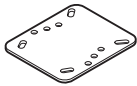

ZUBF-0000-PN
Class CA

Features

- Includes one bracket and mounting screws.
- Mounts straight end of convergent worksurfaces or conference end worksurfaces to panel-hung worksurfaces.
- Standard in black finish color only.
- Provides attachment of two worksurfaces at the same height.

To Order, Specify:

- 1) Product number.
(No finish specification required.)

Depth	Width	Number	Price
3" (76mm)	4" (102mm)	ZUBF-0000-PN	\$35.85

Work Rail Top Trim Off-Modular Bracket

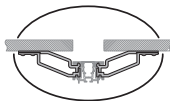
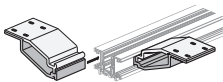

ZZBD
Class BC

Features

- Includes one bracket and attachment hardware.
- Installs in the side channel of Work Rail Top Trim.
- Provides worksurface support in modular or off-modular conditions.
- Bracket for use with Adaptable Worksurfaces.
- Locates underside of worksurface at 28" (711mm) when frame legs/panel glides are fully recessed.
- Provides clear leg support when supporting 24" (610mm) and 30" (762mm)D worksurfaces.

To Order, Specify:

- 1) Product number.
- 2) Trim color.

Specification Tips

- Worksurface front corners support requirements:
 - One corner must be floor supported.
 - Second corner must be either floor supported or attached to an adjacent worksurface with a flush mount kit.
 - The distance between these floor supports may not exceed 10 feet.
- For use with Work Rail Top Trim only.

Bracket Requirements

Length of a particular worksurface Connections spine (inches)	Min # of Brackets Required (qty)
24-42	2
48-78	3
84-120	4

Number	Trim	
	A	B
ZZBD-0200-CNG	\$194.41	\$202.19

Worksurface Support

Gallery Panel Attachment Bracket

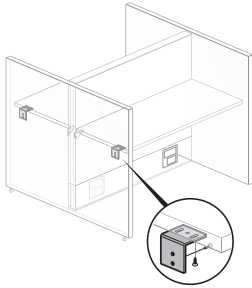

ZUBW-0000-PN
ZUBW-0000-CN
Class BOX

Feature

- Includes: one steel non-handed bracket and hardware.

Specification Tips

- Use ZUBW-0000-PN brackets (standard in Black) or ZUBW-0000-CN (requires trim color specification) with Adaptable Worksurfaces.
- Use two ZUBW-0000-PN or ZUBW-0000-CN Attachment Brackets for each 90° Gallery Panel to Gallery Panel condition.
- Bracket also used as WS to wall bracket. See page 292.
- Refer to Specification Guide for planning information.

To Order, Specify:

- Product number.
- Trim color (if applicable).

Description	Depth	Width	Number	Price	Trim	
					A	B
Attachment Bracket (Black)	2"(51mm)	2"(51mm)	ZUBW-0000-PN	\$38.18	N/A	N/A
Attachment Bracket (trim color required)	2"(51mm)	2"(51mm)	ZUBW-0000-CN		44.27	\$52.00

Convergent Bracket

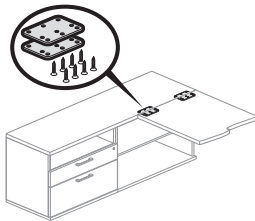

ZBBC-0000-SN
Class CA

Features

- Includes two black painted steel bracket and eight screws.

Specification Tips

- Attaches perpendicular worksurface to front, underside of modular lower storage top or common top.
- For use with open or sliding door modular lower storage.
- Not for use with storage on legs.

To Order, Specify:

- Product number.
(No finish specification required.)

Number	Price
ZBBC-0000-SN	\$27.34

Worksurface Support

Countertop Bracket Kit

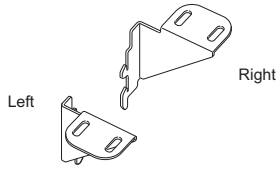

ZZBT
Class CA

Feature

- Includes two left-hand and two right-hand countertop brackets and mounting screws.

Specification Tips

- Not for use with glass panels or glass stacks.
- For countertop widths larger than 60"(1524mm), order two countertop bracket kits.

To Order, Specify:

- 1) Product number.
- 2) Trim color.

Height	Depth	Width	Description	Number	Trim	
					A	B
3"(76mm)	1.5"(38mm)	3"(76mm)	For use with Aluminum trim and wood	ZZBT-0000-PNE	\$134.24	\$135.88
3"(76mm)	1.5"(38mm)	3"(76mm)	For use with thin profile steel trim	ZZBT-0000-PNH	147.24	148.88

Gallery Panel Countertop/OSU Bracket Kit

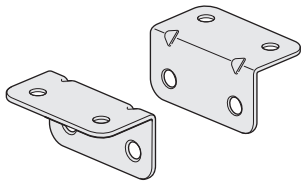

ZYBT-0000-PNY
Class BOX

Features

- Includes two countertop/OSU brackets and mounting screws.
- Field installed.

Specification Tips

- Specify two countertop bracket kits for countertops up to 60"(1524mm). For countertops larger than 60"(1524mm), order three countertop bracket kits.
- Must be placed on each side of the countertop or OSU.

To Order, Specify:

- 1) Product number.
- 2) Trim color.

Height	Depth	Width	Number	Trim	
				A	B
1"(25mm)	1"(25mm)	2"(51mm)	ZYBT-0000-PNY	\$67.12	\$68.76

Worksurface Support

Column Leg

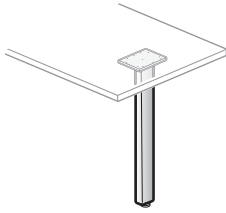

AUC1
Class IN - GSA Open Market

Features

- Includes one leg, glides and attachment hardware.
- Legs are painted metal.

Specification Tips

- One end of worksurface must be panel attached. Not to be used as freestanding.
- Leg will be inset a minimum of 2"(51mm) on worksurface to clear knife edge.

To Order, Specify:

- 1) Product number.
- 2) Trim color.

Height	Description	Number	Trim A	B
28"(711mm)	Single	AUC1-2900-ANFG	\$240.98	\$259.53

Straight Leg Basic — Height Adjustable



WUCL-0001
Class CA

Features

- Includes one leg and mounting screws.
- 4"(102mm) glide adjustment range allows worksurface heights from 27"(686mm) to 31"(787mm).
- 2.25"(57mm) diameter column includes 6"(152mm)-diameter top plate.
- Standard in Charcoal finish only.
- Shipped assembled.

To Order, Specify:

- 1) Product number.
(No finish specification required.)

Number	Price
WUCL-0001	\$268.52

Single Support Leg

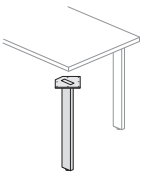

ZUFJ
Class CA

Features

- Includes one support leg and mounting hardware.
- Glide provides 0.5"(13mm) of height adjustment.

Specification Tips

- **One end of worksurface must be panel attached, not to be used as freestanding.**
- A quantity of two Support Columns required to support the outboard end of a Rectangular Convergent worksurface.

To Order, Specify:

- 1) Product number.
- 2) Trim color.

Height	Depth	Width	Number	Trim A	B
28"(711mm)	3.25"(83mm)	1.125"(29mm)	ZUFJ-0101-PNFG	\$280.53	\$304.50

Worksurface Support

Support Post — Height Adjustable



ZZFJ
Class CA

Features

- Includes one single post and mounting hardware.
- 6"(152mm) height adjustment (26"(660mm)-32"(813mm)).

Specification Tips

- **One end of worksurface must be panel attached, not to be used as freestanding.**
- Height adjustable leg has limited range with Connections and Beam frames.
- A quantity of two Support Columns required to support the outboard end of a Rectangular Convergent worksurface.

To Order, Specify:

- 1) Product number.
- 2) Trim color.

Height Adjustable	Number	Trim	
		A	B
26"(660mm)/32"(813mm)	ZZFJ-0101-PNFG	\$497.69	\$520.78

Support Column

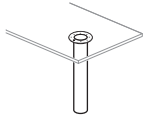

WUCC-0004
Class CA

Features

- Includes one 27"(686mm)H column with glides and mounting screws.
- Glides provide 1.5"(38mm) leveling adjustability.
- 3"(76mm)-diameter column includes 6"(152mm) diameter top plate.

To Order, Specify:

- 1) Product number.
- 2) Trim color.

Height	Number	Trim	
		A	B
27"(686mm)	WUCC-0004	\$434.98	\$456.27

Worksurface Support

End Leg Kit

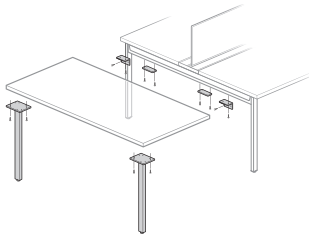

ZBE2-0000-PNFG

Features

- Includes two fixed-height steel legs, brackets, and attachment hardware.
- Legs are 28" (711mm) to bottom of worksurface with glides fully recessed.
- Glides provide 0.5" (13mm) leveling adjustment.
- Field assembled.

Specification Tips

- Supports one end of a worksurface.
- Not for use as freestanding.

To Order, Specify:

- 1) Product number.
- 2) Trim color.

Description	Number	Trim	
		A	B
Straight Leg	ZBE2-0000-PNFG	\$673.33	\$692.86
Angled Leg	ZBA2-0000-PNFG	673.33	692.86

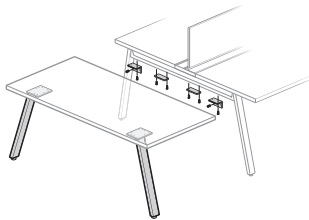

ZBA2-0000-PNFG
Class IN

Return Leg Kit

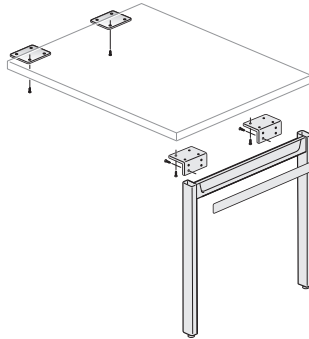

ZBI2-0030-HNFG

Features

- Includes one fixed-height leg assembly, brackets, and attachment hardware.
- Leg is 28" (711mm) to bottom of worksurface with glides fully recessed.
- Glides provide 0.5" (13mm) leveling adjustment.
- Field assembled.

Specification Tip

- Supports end of worksurface.

To Order, Specify:

- 1) Product number.
- 2) Leg color.
- 3) Accent plate color.

Note: Upcharge for mixed grade trim surfaces; please refer to the electronic design and specification tools for pricing.

Height	Depth	Number	Trim	
			A	B
Straight Leg				
24" (610mm)	Non-Handed	ZBI2-0024-HNFG	\$485.42	\$ 521.24
30" (762mm)	Non-Handed	ZBI2-0030-HNFG	550.53	586.35
Angled Leg				
24" (610mm)	Left-Hand	ZBA2-0024-HLFG	\$485.42	\$ 521.24
	Right-Hand	ZBA2-0024-HRFG	485.42	521.24
30" (762mm)	Left-Hand	ZBA2-0030-HLFG	\$550.53	\$586.35
	Right-Hand	ZBA2-0030-HRFG	550.53	586.35

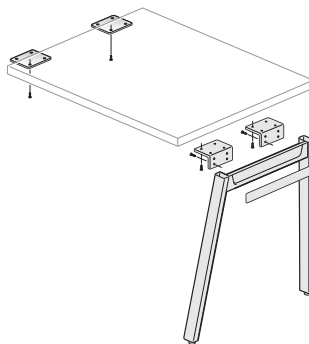

ZBA2-0030-HRFG
Class IN

Worksurface Support

P-Leg

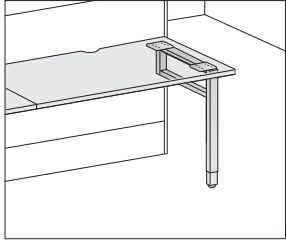

ZZFJ
Class CA

Features

- Includes mounting bracket and mounting hardware with one adjustable or fixed height aluminum P-leg, or one fixed height steel P-leg.
- Installs in panel frame component slots.
- Non-handed design may be installed in left-hand, right-hand or shared configuration.
- Provides full support for one end of equal depth worksurface.
- 6"(152mm) adjustment range on adjustable height P-leg allows worksurface heights from 26"(660mm) to 32"(813mm).
- 1"(25mm) adjustment glide on fixed leg.

Specification Tips

- Not intended to support overhead storage unit at end of run.
- Not designed to be used with knife edge.
- Height adjustable leg has limited range with Connections and Beam frame.

To Order, Specify:

- 1) Product number.
- 2) Trim color.

Height	Depth	Number	Trim A	B
Adjustable Height - Aluminum				
26"(660mm)-32"(813mm)	18"(457mm)	ZZFJ-1800-PNE	\$656.03	\$679.21
	24"(610mm)	ZZFJ-2400-PNE	704.18	727.36
	30"(762mm)	ZZFJ-3000-PNE	752.33	775.51
Fixed Height - Aluminum				
28"(711mm)	18"(457mm)	ZZFJ-1800-PNEF	\$656.03	\$679.21
	24"(610mm)	ZZFJ-2400-PNEF	704.18	727.36
	30"(762mm)	ZZFJ-3000-PNEF	752.33	775.51
Fixed Height - Steel				
28"(711mm)	18"(457mm)	ZZFP-1800-PNEF	\$470.63	\$493.81
	24"(610mm)	ZZFP-2400-PNEF	518.78	541.96
	30"(762mm)	ZZFP-3000-PNEF	566.93	590.11

Double Support Leg

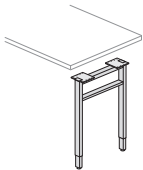

ZZFK
ZZFD
Class CA

Features

- Includes mounting hardware with one adjustable height aluminum double support leg, or one fixed height steel or aluminum double support leg.
- Leg may be installed in left-hand or right-hand configuration.
- 6"(152mm) adjustment range on adjustable double support leg allows worksurface heights from 26"(660mm) to 32"(813mm).
- 1"(25mm) adjustment glide on fixed leg.
- Provides full support for one end of equal depth worksurface.

Specification Tips

- Typically used to support one end of panel attached convergent worksurface.
- Double leg with glide can be used to replace support post or support column.
- Use reduced depth support leg below worksurface. Example: 24"(610mm)D double support leg.
- Can be used in Freestanding applications.
 - Each leg must be within 6 inches of side edge of worksurface.
 - Span between legs must not exceed 60"(1524mm).
- Height adjustable leg has limited range with Connections and Beam frame.
- Not designed to be used with knife edge.

To Order, Specify:

- 1) Product number.
- 2) Trim color.

Height	Depth	Number	Trim A	B
Adjustable Height - Aluminum				
26"(660mm)-32"(813mm)	18"(457mm)	ZZFK-1800-PNFG	\$840.27	\$863.22
	24"(610mm)	ZZFK-2400-PNFG	884.47	907.42
	30"(762mm)	ZZFK-3000-PNFG	928.67	951.62
Fixed Height - Aluminum				
28"(711mm)	18"(457mm)	ZZFK-1800-PNFF	\$840.27	\$863.22
	24"(610mm)	ZZFK-2400-PNFF	884.47	907.42
	30"(762mm)	ZZFK-3000-PNFF	928.67	951.62
Fixed Height - Steel				
28"(711mm)	18"(457mm)	ZZFD-1800-PNFF	\$556.54	\$579.49
	24"(610mm)	ZZFD-2400-PNFF	600.74	623.69
	30"(762mm)	ZZFD-3000-PNFF	644.94	667.89

Worksurface Accessories

Worksurface Reinforcement Channel

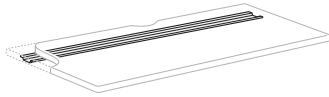

WUAR
Class CA

Features

- Includes metal, U-shaped channel and mounting screws.
- Field installed, located and drilled per installation instructions.
- Worksurface reinforcement channels must be specified to provide additional support for laminate or wood worksurfaces with 50"(1270mm) or larger spans that are not otherwise supported by mid-span cantilevers, worksurface supports, legs, or under-worksurface storage.
- Specify worksurface reinforcement channel in length that won't interfere with lower storage

Specification Tips

- Worksurface reinforcement channels are recommended for worksurface spans of 50"(1270mm)-72"(1829mm). 72"(1829mm) span or greater requires a reinforcement bar.
- All pedestals under 25"(635mm)H can be used under a worksurface with a worksurface reinforcement channel.

To Order, Specify:

- 1) Product number.
(No finish specification required.)

Length	Number	Price
16"(406mm)	WUAR-1600-PH	\$109.96
24"(610mm)	WUAR-2400-PH	114.12
32"(813mm)	WUAR-3200-PH	118.28
39"(991mm)	WUAR-3900-PH	121.92
47"(1194mm)	WUAR-4700-PH	126.08
54"(1372mm)	WUAR-5400-PH	129.72

Worksurface Reinforcement Bar

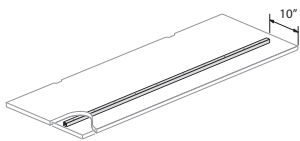

WUAR-PHS
Class CA

Features

- Includes metal tube and mounting screws.
- Field installed, located and drilled per installation instructions; 10"(254mm) from user edge of the worksurface.

Specification Tips

- Not recommended for use with keyboard trays or AKPs. Use shorter length, as needed, to accommodate other under worksurface support components.
- Pedestals under 25"(635mm)H can be used under a worksurface with a worksurface reinforcement bar.
- A minimum 72"(1829mm) worksurface reinforcement bar must be specified to provide additional support on a contiguous laminate or wood worksurface with 72"(1829mm) or greater gap between floor supports. Where feasible; longer worksurface reinforcement bars provide additional strength.
- See Load and Support guidelines for details.

To Order, Specify:

- 1) Product number.
(No finish specification required.)

Length	Height	Number	Price
48"(1219mm)	1.5"(38mm)	WUAR-4800-PHS	\$ 269.73
60"(1524mm)	1.5"(38mm)	WUAR-6000-PHS	300.85
72"(1829mm)	1.5"(38mm)	WUAR-7200-PHS	331.97
96"(2438mm)	1.5"(38mm)	WUAR-9600-PHS	394.21
120"(3048mm)	1.5"(38mm)	WUAR-C000-PHS	555.12

Worksurface Accessories

Stanchions

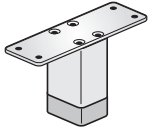

ZZBP-0300-PAN

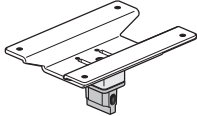

ZZBP-0100-PAN

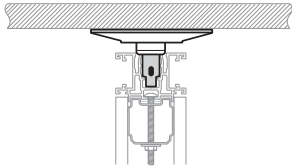

ZZBP-0100-PGN
Class BCX

Features

- Includes one painted stanchion and attachment hardware.
- Supports adaptable worksurfaces or desk-height countertop in parallel or perpendicular applications.

Specification Tips

- Refer to Specification Guide for planning guidelines.
- Not for use with Steel Trim.

To Order, Specify:

- 1) Product number.
- 2) Trim color.

Description	Height	Depth	Width	Number	Trim	
					A	B
For use with Aluminum Top Trim	2.5"(64mm)	1.5"(38mm)	1.906"(48mm)	ZZBP-0300-PAN	\$173.20	\$183.98
For use with Work Rail Top Trim	6.375"(162mm)	2"(51mm)	7.25"(184mm)	ZZBP-0100-PGN	204.01	211.71

Panel-to-Storage Bracket

Be_Hold

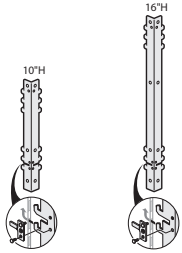

ZZBF-1000-PNA ZZBF-1600-PNA

Compose Storage

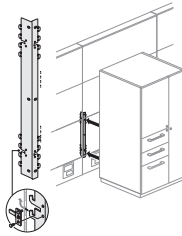

ZZBF-PNB

X Series – Attached Pedestal

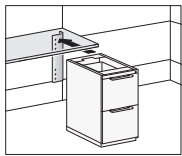

ZZBN-0000-PNJ

X and V Series Attached 2H Storage

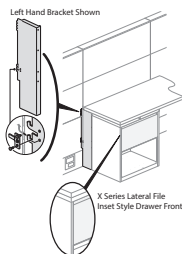

ZZBF-PLL

Beside Pantry / X and V Series Freestanding

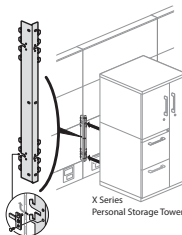

ZZBF-PNW

Class CA

Common Features

- Includes one bracket and mounting hardware.
- Available in user specified trim colors.
- Installs in Compose panel frame slots and attaches to a storage unit; requires field drilling storage unit.

Specification Tips

- Provides floor support to a Compose full panel frame application. See Support and Load Guidelines for details.
- Installation requires field drilling of storage unit.
- Not for use with Compose glass panels, Connections or Beam.

Be_Hold Storage

- 1.5H attached lower storage - Order 10"(254mm)H bracket - ZZBF-1000-PNA
- 2H & 3H attached lower storage and freestanding storage - Order 16"(406mm)H bracket - ZZBF-1600-PNA
- One non-handed bracket.
- Bracket may be used with inset or proud lower storage back.
- 1.5H lower storage must be attached perpendicular to Compose panel run.
- 2H or greater freestanding or attached lower storage may be attached perpendicular or parallel to Compose panel run.

Beside Pantry

- Order ZZBF-1800-PNW
- One non-handed bracket.
- Storage unit to run parallel to Compose panel run.

Compose Storage

- 1.5H Storage - Order 10"(254mm)H bracket - ZZBF-1000-PNB
- 2H Storage - Order 16"(406mm)H bracket - ZZBF-1600-PNB
- 3H Storage, Personal Storage Tower and Wardrobe - Order 28"(711mm)H bracket - ZZBF-2800-PNB
- One non-handed bracket.
- Must be attached parallel to Compose Panel run.
- For use with Chamfer Leg, Plinth or Side Panel Base with unfinished back or separately specified finished proud back.

X Series Attached Pedestal

- Order ZZBN-0000-PNJ
- One non-handed bracket.
- For use with 3mm edgeband worksurfaces.

X and V Series Attached 2H Storage

- Inset Front: RH: ZZBF-____-PRLR / LH: ZZBF-____-PLLR
- Proud Front: RH: ZZBF-____-PRLP / LH: ZZBF-____-PLLP
- One left- or right-hand bracket.
- 2H Attached Storage includes Lateral Files, Combination Units and Storage Cabinet.
- For use with 24"(610mm) or 30"(762mm)D Adaptable worksurface; Specify accordingly.
- Storage unit to run parallel to Compose panel run.
- Bracket specification dependent on Proud or Inset front.

X and V Series 1.5H Freestanding Storage, 12"(305mm)W

- Lockers, Compose 26"(660mm)H**
- Order 12"(305mm)H bracket - ZZBF-1200-PNW
- One non-handed bracket.
- Storage unit to run parallel to Compose panel run.

X and V Series 2H or greater Freestanding Storage, Personal Storage Tower (PST), Lockers, Wardrobe Units

- Order 18.5"(470mm)H bracket - ZZBF-1800-PNW
- One non-handed bracket.
- Storage unit to run parallel to Compose panel run.

To Order, Specify:

1) Product number.

1 Handedness

(X & V Series 2H attached only)

R Right

L Left

2) Trim color.

Panel-to-Storage Bracket

Product	Product Description	Bracket Height	Worksurface Depth	Number ①	Trim	
					A	B
Be_Hold	1.5H	10"(254mm)		ZZBF-1000-PNA	\$ 139.97	\$ 160.19
	2H, 3H Freestanding & Attached	16"(406mm)		ZZBF-1600-PNA	139.97	160.19
Beside Pantry	Pantry	18.5"(470mm)		ZZBF-1800-PNW	\$ 139.97	\$ 160.19
Compose Storage	1.5H	10"(254mm)		ZZBF-1000-PNB	\$ 139.97	\$ 160.19
	2H	16"(406mm)		ZZBF-1600-PNB	139.97	160.19
	3H, Personal Storage Tower, Wardrobe	28"(711mm)		ZZBF-2800-PNB	139.97	160.19
X Series	Attached Pedestal			ZZBN-0000-PNJ	\$266.35	\$ 287.23
X and V Series (Inset front)	2H Attached (Lateral Files, Combination Units, Storage Cabinet)	27"(686mm)	24"(610mm)	ZZBF-2724-P LR	\$ 326.61	\$346.83
			30"(762mm)	ZZBF-2730-P LR	404.38	424.60
X and V Series (Proud front)	2H Attached (Lateral Files, Combination Units, Storage Cabinet)	27"(686mm)	24"(610mm)	ZZBF-2724-P LP	\$ 326.61	\$346.83
			30"(762mm)	ZZBF-2730-P LP	404.38	424.60
X and V Series	1.5H Freestanding, 12"(305mm)W Lockers, Compose 26"(660mm)H	12"(305mm)		ZZBF-1200-PNW	\$ 139.97	\$ 160.19
X and V Series	2H+ Freestanding, Lockers, Wardrobe, Personal Storage Towers	18.5"(470mm)		ZZBF-1800-PNW	\$ 139.97	\$ 160.19

Upper Storage Storage Box

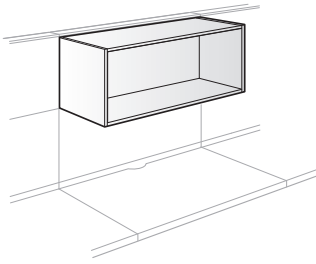

UQFS-LN

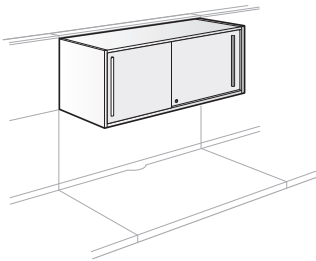

UQFS-LL
UQFS-LW
UQFS-LG

Class CA – GSA Open Market

Features

- Includes high-pressure laminate (HPL) laminate or wood storage box with finished back, attachment hardware and if specified door track with doors.
- Storage Boxes 48”(1219mm)W and greater have a center divider.
- Laminate storage box with 1mm edgeband edges.
- If door option is chosen, two doors with pulls and door track included. Door track is not included when doors are not specified.
- Door track is metallic silver plastic.
- Storage Box inside dimensions:
 - Height: 14”(356mm)
 - Depth: 13”(330mm)
- Optional sliding doors:
 - Available in laminate, wood veneer, glass or acrylic.
 - Doors are standard as half-widths; (i.e.: 96”(2438mm) = two 48”(1219mm) doors).
 - Right-hand door slides behind left-hand door.
 - Doors overlap 1”(25mm) with the following opening sizes:

.30” - 14.75”	.48” - 23.75”	.72” - 35.75”
.36” - 17.75”	.54” - 26.75”	.80” - 39.75”
.40” - 19.75”	.60” - 29.75”	.84” - 41.75”
.42” - 20.75”	.66” - 32.75”	.96” - 47.75”
 - Bar pulls available in trim colors.
 - Optional door lock is located in right door and available in black or chrome.
 - For lock options, refer to Lock Program section of the Accessories Price List.
- Safety interlock prevents dislodgment of storage box from panel component slots.
- Separately specified light options available.

Specification Tips

- One row of 16”(406mm) storage boxes can be used on each panel.
- Laminate or wood doors can be retrofitted with locks.
- Mounting Option (V) can be mounted on Compose wall track - up to 60”(1524mm)W storage box.
- Storage Box wider than 60”(1524mm) may not be used with wall track.

To Order, Specify:

1) Product number, including:

1 Mounting Option:

- V Compose
- W Wall Mount (drywall)

2 Locking Option:

- N None
- L Locking (add **\$118.78** list)

2) Box laminate or wood surface color.

3) Box laminate edge trim color (if applicable).

4) Door surface color/finish.

5) Pull trim color.

6) Lock Plug finish color.

- Black – LR-BL
- Chrome – LR-BP

Upper Storage

Storage Box

Outside Depth	Outside Width	Inside Width	Number	① ②		Case HPL A Trim		Case HPL B Trim	
				A	B	A	B		
Without Doors/16.5"(419mm) Outside Height									
15.75"(400mm)	30"(762mm)	28.25"(718mm)	UQFS-1630-LN	■	NNNA	\$ 1897.41	N/A	\$ 2018.66	N/A
	36"(914mm)	34.25"(870mm)	UQFS-1636-LN	■	NNNA	1976.61	N/A	2103.05	N/A
	40"(1016mm)	28.25"(718mm)	UQFS-1640-LN	■	NNNA	2029.41	N/A	2159.31	N/A
	42"(1067mm)	40.25"(1022mm)	UQFS-1642-LN	■	NNNA	2055.81	N/A	2187.44	N/A
	48"(1219mm)	22.75"(578mm)/22.75"(578mm)	UQFS-1648-LN	■	NNNA	2135.01	N/A	2271.83	N/A
	54"(1372mm)	25.75"(654mm)/25.75"(654mm)	UQFS-1654-LN	■	NNNA	2214.21	N/A	2356.22	N/A
	60"(1524mm)	28.75"(730mm)/28.75"(730mm)	UQFS-1660-LN	■	NNNA	2319.36	N/A	2466.56	N/A
	66"(1676mm)	31.75"(806mm)/31.75"(806mm)	UQFS-1666-LN	■	NNNA	2403.75	N/A	2556.14	N/A
	72"(1829mm)	34.75"(883mm)/34.75"(883mm)	UQFS-1672-LN	■	NNNA	2488.14	N/A	2645.72	N/A
	80"(2032mm)	38.75"(984mm)/38.75"(984mm)	UQFS-1680-LN	■	NNNA	2600.66	N/A	2765.16	N/A
	84"(2134mm)	40.75"(1035mm)/40.75"(1035mm)	UQFS-1684-LN	■	NNNA	2656.92	N/A	2824.88	N/A
	96"(2438mm)	46.75"(1187mm)/46.75"(1187mm)	UQFS-1696-LN	■	NNNA	2914.76	N/A	3093.10	N/A

Outside Depth	Outside Width	Inside Width	Number	① ②		Case HPL A Door HPL A Trim		Door HPL B Trim	
				A	B	A	B		
With Laminate Doors/16.5"(419mm) Outside Height									
15.75"(400mm)	30"(762mm)	28.25"(718mm)	UQFS-1630-LL	■	B NA	\$ 2542.41	\$ 2552.31	\$ 2593.56	\$ 2603.46
	36"(914mm)	34.25"(870mm)	UQFS-1636-LL	■	B NA	2671.08	2680.98	2727.15	2737.05
	40"(1016mm)	28.25"(718mm)	UQFS-1640-LL	■	B NA	2756.86	2766.76	2816.21	2826.11
	42"(1067mm)	40.25"(1022mm)	UQFS-1642-LL	■	B NA	2799.75	2809.65	2860.74	2870.64
	48"(1219mm)	22.75"(578mm)/22.75"(578mm)	UQFS-1648-LL	■	B NA	2928.42	2938.32	2994.33	3004.23
	54"(1372mm)	25.75"(654mm)/25.75"(654mm)	UQFS-1654-LL	■	B NA	3057.09	3066.99	3127.92	3137.82
	60"(1524mm)	28.75"(730mm)/28.75"(730mm)	UQFS-1660-LL	■	B NA	3211.71	3221.61	3287.46	3297.36
	66"(1676mm)	31.75"(806mm)/31.75"(806mm)	UQFS-1666-LL	■	B NA	3345.57	3355.47	3426.24	3436.14
	72"(1829mm)	34.75"(883mm)/34.75"(883mm)	UQFS-1672-LL	■	B NA	3532.23	3542.13	3565.02	3574.92
	80"(2032mm)	38.75"(984mm)/38.75"(984mm)	UQFS-1680-LL	■	B NA	3710.71	3720.61	3750.06	3759.96
	84"(2134mm)	40.75"(1035mm)/40.75"(1035mm)	UQFS-1684-LL	■	B NA	3799.95	3809.85	3842.58	3852.48
	96"(2438mm)	46.75"(1187mm)/46.75"(1187mm)	UQFS-1696-LL	■	B NA	4156.73	4166.63	4209.20	4219.10

Outside Depth	Outside Width	Inside Width	Number	① ②		Case HPL B Door HPL A Trim		Door HPL B Trim	
				A	B	A	B		
With Laminate Doors/16.5"(419mm) Outside Height									
15.75"(400mm)	30"(762mm)	28.25"(718mm)	UQFS-1630-LL	■	B NA	\$ 2663.66	\$ 2673.56	\$ 2714.81	\$ 2724.71
	36"(914mm)	34.25"(870mm)	UQFS-1636-LL	■	B NA	2797.52	2807.42	2853.59	2863.49
	40"(1016mm)	28.25"(718mm)	UQFS-1640-LL	■	B NA	2886.76	2896.66	2946.11	2956.01
	42"(1067mm)	40.25"(1022mm)	UQFS-1642-LL	■	B NA	2931.38	2941.28	2992.37	3002.27
	48"(1219mm)	22.75"(578mm)/22.75"(578mm)	UQFS-1648-LL	■	B NA	3065.24	3075.14	3131.15	3141.05
	54"(1372mm)	25.75"(654mm)/25.75"(654mm)	UQFS-1654-LL	■	B NA	3199.10	3209.00	3269.93	3279.83
	60"(1524mm)	28.75"(730mm)/28.75"(730mm)	UQFS-1660-LL	■	B NA	3358.91	3368.81	3434.66	3444.56
	66"(1676mm)	31.75"(806mm)/31.75"(806mm)	UQFS-1666-LL	■	B NA	3497.96	3507.86	3578.63	3588.53
	72"(1829mm)	34.75"(883mm)/34.75"(883mm)	UQFS-1672-LL	■	B NA	3637.01	3646.91	3722.60	3732.50
	80"(2032mm)	38.75"(984mm)/38.75"(984mm)	UQFS-1680-LL	■	B NA	3822.41	3832.31	3914.56	3924.46
	84"(2134mm)	40.75"(1035mm)/40.75"(1035mm)	UQFS-1684-LL	■	B NA	3915.11	3925.01	4010.54	4020.44
	96"(2438mm)	46.75"(1187mm)/46.75"(1187mm)	UQFS-1696-LL	■	B NA	4282.27	4292.17	4387.54	4397.44

Upper Storage

Storage Box

Outside Depth	Outside Width	Inside Width	Number	①	②	Case HPL A		Door Wood	
						Door Wood A Trim	Door Wood B Trim	A	B
With Wood Doors/16.5"(419mm) Outside Height									
15.75"(400mm)	30"(762mm)	28.25"(718mm)	UQFS-1630-LW	B	NA	\$4065.09	\$4074.99	\$4218.47	\$4228.37
	36"(914mm)	34.25"(870mm)	UQFS-1636-LW	B	NA	4223.49	4233.39	4391.72	4401.62
	40"(1016mm)	28.25"(718mm)	UQFS-1640-LW	B	NA	4329.09	4338.99	4507.22	4517.12
	42"(1067mm)	40.25"(1022mm)	UQFS-1642-LW	B	NA	4381.89	4391.79	4564.97	4574.87
	48"(1219mm)	22.75"(578mm)/22.75"(578mm)	UQFS-1648-LW	B	NA	4540.29	4550.19	4738.22	4748.12
	54"(1372mm)	25.75"(654mm)/25.75"(654mm)	UQFS-1654-LW	B	NA	4698.69	4708.59	4911.47	4921.37
	60"(1524mm)	28.75"(730mm)/28.75"(730mm)	UQFS-1660-LW	B	NA	4883.04	4892.94	5110.67	5120.57
	66"(1676mm)	31.75"(806mm)/31.75"(806mm)	UQFS-1666-LW	B	NA	5046.63	5056.53	5289.11	5299.01
	72"(1829mm)	34.75"(883mm)/34.75"(883mm)	UQFS-1672-LW	B	NA	5210.22	5220.12	5467.55	5477.45
	80"(2032mm)	38.75"(984mm)/38.75"(984mm)	UQFS-1680-LW	B	NA	5428.34	5438.24	5705.47	5715.37
	84"(2134mm)	40.75"(1035mm)/40.75"(1035mm)	UQFS-1684-LW	B	NA	5537.40	5547.30	5824.43	5834.33
	96"(2438mm)	46.75"(1187mm)/46.75"(1187mm)	UQFS-1696-LW	B	NA	5953.64	5963.54	6270.37	6280.27

Outside Depth	Outside Width	Inside Width	Number	①	②	Case HPL B		Door Wood	
						Door Wood A Trim	Door Wood B Trim	A	B
With Wood Doors/16.5"(419mm) Outside Height									
15.75"(400mm)	30"(762mm)	28.25"(718mm)	UQFS-1630-LW	B	NA	\$4186.34	\$4196.24	\$4339.72	\$4349.62
	36"(914mm)	34.25"(870mm)	UQFS-1636-LW	B	NA	4349.93	4359.83	4518.16	4528.06
	40"(1016mm)	28.25"(718mm)	UQFS-1640-LW	B	NA	4458.99	4468.89	4637.12	4647.02
	42"(1067mm)	40.25"(1022mm)	UQFS-1642-LW	B	NA	4513.52	4523.42	4696.60	4706.50
	48"(1219mm)	22.75"(578mm)/22.75"(578mm)	UQFS-1648-LW	B	NA	4677.11	4687.01	4875.04	4884.94
	54"(1372mm)	25.75"(654mm)/25.75"(654mm)	UQFS-1654-LW	B	NA	4840.70	4850.60	5053.48	5063.38
	60"(1524mm)	28.75"(730mm)/28.75"(730mm)	UQFS-1660-LW	B	NA	5030.24	5040.14	5257.87	5267.77
	66"(1676mm)	31.75"(806mm)/31.75"(806mm)	UQFS-1666-LW	B	NA	5199.02	5208.92	5441.50	5451.40
	72"(1829mm)	34.75"(883mm)/34.75"(883mm)	UQFS-1672-LW	B	NA	5367.80	5377.70	5625.13	5635.03
	80"(2032mm)	38.75"(984mm)/38.75"(984mm)	UQFS-1680-LW	B	NA	5592.84	5602.74	5869.97	5879.87
	84"(2134mm)	40.75"(1035mm)/40.75"(1035mm)	UQFS-1684-LW	B	NA	5705.36	5715.26	5992.39	6002.29
	96"(2438mm)	46.75"(1187mm)/46.75"(1187mm)	UQFS-1696-LW	B	NA	6131.98	6141.88	6448.71	6458.61

Upper Storage

Storage Box

Outside Width	Number	①	②	Case HPL A							
				Door Glass A		Door Glass C		Door Glass F		Door Acrylic	
				Trim A	B	Trim A	B	Trim A	B	Trim A	B
With Glass or Acrylic Doors/16.5"(419mm) Outside Height - 15.75"(400mm) Outside Depth											
30"(762mm)	UQFS-1630-LG	B	NA	\$ 3232.26	\$ 3242.16	\$ 4572.97	\$ 4582.87	\$ 5545.74	\$ 5555.64	\$ 3232.26	\$ 3242.16
36"(914mm)	UQFS-1636-LG	B	NA	3399.45	3409.35	4857.58	4867.48	5906.67	5916.57	3311.46	3321.36
40"(1016mm)	UQFS-1640-LG	B	NA	3510.91	3520.81	5047.32	5057.22	6147.29	6157.19	3364.26	3374.16
42"(1067mm)	UQFS-1642-LG	B	NA	3566.64	3576.54	5142.19	5152.09	6267.60	6277.50	3390.66	3400.56
48"(1219mm)	UQFS-1648-LG	B	NA	3838.22	3848.12	5426.80	5436.70	6628.53	6638.43	3469.86	3479.76
54"(1372mm)	UQFS-1654-LG	B	NA	4018.46	4028.36	5711.41	5721.31	6989.46	6999.36	3549.06	3558.96
60"(1524mm)	UQFS-1660-LG	B	NA	4138.98	4148.88	6066.79	6076.69	7421.16	7431.06	3654.21	3664.11
66"(1676mm)	UQFS-1666-LG	B	NA	4356.18	4366.08	6401.41	6411.31	7832.10	7842.00	3738.60	3748.50
72"(1829mm)	UQFS-1672-LG	B	NA	4573.38	4583.28	6736.03	6745.93	8243.04	8252.94	3822.99	3832.89
80"(2032mm)	UQFS-1680-LG	B	NA	4862.98	4872.88	7182.19	7192.09	8790.96	8800.86	3935.51	3945.41
84"(2134mm)	UQFS-1684-LG	B	NA	5007.78	5017.68	7405.27	7415.17	9064.92	9074.82	3991.77	4001.67
96"(2438mm)	UQFS-1696-LG	B	NA	5531.24	5541.14	8163.57	8173.47	9975.86	9985.76	4249.61	4259.51

Refer to page 269 for inside width dimensions.

Outside Width	Number	①	②	Case HPL B							
				Door Glass A		Door Glass C		Door Glass F		Door Acrylic	
				Trim A	B	Trim A	B	Trim A	B	Trim A	B
With Glass or Acrylic Doors/16.5"(419mm) Outside Height - 15.75"(400mm) Outside Depth											
30"(762mm)	UQFS-1630-LG	B	NA	\$ 3353.51	\$ 3363.41	\$ 4694.22	\$ 4704.12	\$ 5666.99	\$ 5676.89	\$ 3353.51	\$ 3363.41
36"(914mm)	UQFS-1636-LG	B	NA	3525.89	3535.79	4984.02	4993.92	6033.11	6043.01	3437.90	3447.80
40"(1016mm)	UQFS-1640-LG	B	NA	3640.81	3650.71	5177.22	5187.12	6277.19	6287.09	3494.16	3504.06
42"(1067mm)	UQFS-1642-LG	B	NA	3698.27	3708.17	5273.82	5283.72	6399.23	6409.13	3522.29	3532.19
48"(1219mm)	UQFS-1648-LG	B	NA	3870.65	3880.55	5563.62	5573.52	6765.35	6775.25	3606.68	3616.58
54"(1372mm)	UQFS-1654-LG	B	NA	4043.03	4052.93	5853.42	5863.32	7131.47	7141.37	3691.07	3700.97
60"(1524mm)	UQFS-1660-LG	B	NA	4286.18	4296.08	6213.99	6223.89	7568.36	7578.26	3801.41	3811.31
66"(1676mm)	UQFS-1666-LG	B	NA	4508.57	4518.47	6553.80	6563.70	7984.49	7994.39	3890.99	3900.89
72"(1829mm)	UQFS-1672-LG	B	NA	4730.96	4740.86	6893.61	6903.51	8400.62	8410.52	3980.57	3990.47
80"(2032mm)	UQFS-1680-LG	B	NA	5027.48	5037.38	7346.69	7356.59	8955.46	8965.36	4100.01	4109.91
84"(2134mm)	UQFS-1684-LG	B	NA	5175.74	5185.64	7573.23	7583.13	9232.88	9242.78	4159.73	4169.63
96"(2438mm)	UQFS-1696-LG	B	NA	5709.58	5719.48	8341.91	8351.81	10154.20	10164.10	4427.95	4437.85

Refer to page 269 for inside width dimensions.

Upper Storage

Storage Box

Outside Depth	Outside Width	Inside Width	Number	① ②	Case Wood A Trim		Case Wood B Trim	
					A	B	A	B
Without Doors/16.5"(419mm) Outside Height								
15.75"(400mm)	30"(762mm)	28.25"(718mm)	UQFS-1630-WN	NNNA	\$4635.85	N/A	\$ 4891.64	N/A
	36"(914mm)	34.25"(870mm)	UQFS-1636-WN	NNNA	4789.09	N/A	5058.05	N/A
	40"(1016mm)	28.25"(718mm)	UQFS-1640-WN	NNNA	4891.25	N/A	5168.99	N/A
	42"(1067mm)	40.25"(1022mm)	UQFS-1642-WN	NNNA	4942.33	N/A	5224.46	N/A
	48"(1219mm)	22.75"(578mm)/22.75"(578mm)	UQFS-1648-WN	NNNA	5095.57	N/A	5390.87	N/A
	54"(1372mm)	25.75"(654mm)/25.75"(654mm)	UQFS-1654-WN	NNNA	5248.81	N/A	5557.28	N/A
	60"(1524mm)	28.75"(730mm)/28.75"(730mm)	UQFS-1660-WN	NNNA	5428.00	N/A	5749.64	N/A
	66"(1676mm)	31.75"(806mm)/31.75"(806mm)	UQFS-1666-WN	NNNA	5586.43	N/A	5921.24	N/A
	72"(1829mm)	34.75"(883mm)/34.75"(883mm)	UQFS-1672-WN	NNNA	5744.86	N/A	6092.84	N/A
	80"(2032mm)	38.75"(984mm)/38.75"(984mm)	UQFS-1680-WN	NNNA	5956.10	N/A	6321.64	N/A
	84"(2134mm)	40.75"(1035mm)/40.75"(1035mm)	UQFS-1684-WN	NNNA	6061.72	N/A	6436.04	N/A
	96"(2438mm)	46.75"(1187mm)/46.75"(1187mm)	UQFS-1696-WN	NNNA	6467.64	N/A	6868.30	N/A

Outside Depth	Outside Width	Inside Width	Number	① ②	Case Wood A Door HPL Trim		Case Wood B Door HPL Trim	
					A	B	A	B
With Laminate Doors/16.5"(419mm) Outside Height								
15.75"(400mm)	30"(762mm)	28.25"(718mm)	UQFS-1630-WL	B NA	\$5280.85	\$5290.75	\$5332.00	\$ 5341.90
	36"(914mm)	34.25"(870mm)	UQFS-1636-WL	B NA	5483.56	5493.46	5539.63	5549.53
	40"(1016mm)	28.25"(718mm)	UQFS-1640-WL	B NA	5618.70	5628.60	5678.05	5687.95
	42"(1067mm)	40.25"(1022mm)	UQFS-1642-WL	B NA	5686.27	5696.17	5747.26	5757.16
	48"(1219mm)	22.75"(578mm)/22.75"(578mm)	UQFS-1648-WL	B NA	5888.98	5898.88	5954.89	5964.79
	54"(1372mm)	25.75"(654mm)/25.75"(654mm)	UQFS-1654-WL	B NA	6091.69	6101.59	6162.52	6172.42
	60"(1524mm)	28.75"(730mm)/28.75"(730mm)	UQFS-1660-WL	B NA	6320.35	6330.25	6396.10	6406.00
	66"(1676mm)	31.75"(806mm)/31.75"(806mm)	UQFS-1666-WL	B NA	6528.25	6538.15	6608.92	6618.82
	72"(1829mm)	34.75"(883mm)/34.75"(883mm)	UQFS-1672-WL	B NA	6736.15	6746.05	6821.74	6831.64
	80"(2032mm)	38.75"(984mm)/38.75"(984mm)	UQFS-1680-WL	B NA	7013.35	7023.25	7105.50	7115.40
	84"(2134mm)	40.75"(1035mm)/40.75"(1035mm)	UQFS-1684-WL	B NA	7151.95	7161.85	7247.38	7257.28
	96"(2438mm)	46.75"(1187mm)/46.75"(1187mm)	UQFS-1696-WL	B NA	7656.81	7666.71	7762.08	7771.98

Outside Depth	Outside Width	Inside Width	Number	① ②	Case Wood B Door HPL Trim		Case Wood A Door HPL Trim	
					A	B	A	B
With Laminate Doors/16.5"(419mm) Outside Height								
15.75"(400mm)	30"(762mm)	28.25"(718mm)	UQFS-1630-WL	B NA	\$5536.64	\$5546.54	\$ 5587.79	\$ 5597.69
	36"(914mm)	34.25"(870mm)	UQFS-1636-WL	B NA	5752.52	5762.42	5808.59	5818.49
	40"(1016mm)	28.25"(718mm)	UQFS-1640-WL	B NA	5896.44	5906.34	5955.79	5965.69
	42"(1067mm)	40.25"(1022mm)	UQFS-1642-WL	B NA	5968.40	5978.30	6029.39	6039.29
	48"(1219mm)	22.75"(578mm)/22.75"(578mm)	UQFS-1648-WL	B NA	6184.28	6194.18	6250.19	6260.09
	54"(1372mm)	25.75"(654mm)/25.75"(654mm)	UQFS-1654-WL	B NA	6400.16	6410.06	6470.99	6480.89
	60"(1524mm)	28.75"(730mm)/28.75"(730mm)	UQFS-1660-WL	B NA	6641.99	6651.89	6717.74	6727.64
	66"(1676mm)	31.75"(806mm)/31.75"(806mm)	UQFS-1666-WL	B NA	6863.06	6872.96	6943.73	6953.63
	72"(1829mm)	34.75"(883mm)/34.75"(883mm)	UQFS-1672-WL	B NA	7084.13	7094.03	7169.72	7179.62
	80"(2032mm)	38.75"(984mm)/38.75"(984mm)	UQFS-1680-WL	B NA	7378.89	7388.79	7471.04	7480.94
	84"(2134mm)	40.75"(1035mm)/40.75"(1035mm)	UQFS-1684-WL	B NA	7526.27	7536.17	7621.70	7631.60
	96"(2438mm)	46.75"(1187mm)/46.75"(1187mm)	UQFS-1696-WL	B NA	8057.47	8067.37	8162.74	8172.64

Upper Storage

Storage Box

Outside Depth	Outside Width	Inside Width	Number	①	②	Case Wood A		Door Wood	
						Door Wood A	Door Wood B	Trim A	Trim B
With Wood Doors/16.5"(419mm) Outside Height									
15.75"(400mm)	30"(762mm)	28.25"(718mm)	UQFS-1630-WW	B	NA	\$ 5503.53	\$ 5513.43	\$ 5656.91	\$ 5666.81
	36"(914mm)	34.25"(870mm)	UQFS-1636-WW	B	NA	5735.97	5745.87	5904.20	5914.10
	40"(1016mm)	28.25"(718mm)	UQFS-1640-WW	B	NA	5890.93	5900.83	6069.06	6078.96
	42"(1067mm)	40.25"(1022mm)	UQFS-1642-WW	B	NA	5968.41	5978.31	6151.49	6161.39
	48"(1219mm)	22.75"(578mm)/22.75"(578mm)	UQFS-1648-WW	B	NA	6200.85	6210.75	6398.78	6408.68
	54"(1372mm)	25.75"(654mm)/25.75"(654mm)	UQFS-1654-WW	B	NA	6433.29	6443.19	6646.07	6655.97
	60"(1524mm)	28.75"(730mm)/28.75"(730mm)	UQFS-1660-WW	B	NA	6691.68	6701.58	6919.31	6929.21
	66"(1676mm)	31.75"(806mm)/31.75"(806mm)	UQFS-1666-WW	B	NA	6929.31	6939.21	7171.79	7181.69
	72"(1829mm)	34.75"(883mm)/34.75"(883mm)	UQFS-1672-WW	B	NA	7166.94	7176.84	7424.27	7434.17
	80"(2032mm)	38.75"(984mm)/38.75"(984mm)	UQFS-1680-WW	B	NA	7483.78	7493.68	7760.91	7770.81
	84"(2134mm)	40.75"(1035mm)/40.75"(1035mm)	UQFS-1684-WW	B	NA	7642.20	7652.10	7929.23	7939.13
	96"(2438mm)	46.75"(1187mm)/46.75"(1187mm)	UQFS-1696-WW	B	NA	8206.52	8216.42	8523.25	8533.15

Outside Depth	Outside Width	Inside Width	Number	①	②	Case Wood B		Door Wood	
						Door Wood A	Door Wood B	Trim A	Trim B
With Wood Doors/16.5"(419mm) Outside Height									
15.75"(400mm)	30"(762mm)	28.25"(718mm)	UQFS-1630-WW	B	NA	\$ 5759.32	\$ 5769.22	\$ 5912.70	\$ 5922.60
	36"(914mm)	34.25"(870mm)	UQFS-1636-WW	B	NA	6004.93	6014.83	6173.16	6183.06
	40"(1016mm)	28.25"(718mm)	UQFS-1640-WW	B	NA	6168.67	6178.57	6346.80	6356.70
	42"(1067mm)	40.25"(1022mm)	UQFS-1642-WW	B	NA	6250.54	6260.44	6433.62	6443.52
	48"(1219mm)	22.75"(578mm)/22.75"(578mm)	UQFS-1648-WW	B	NA	6496.15	6506.05	6694.08	6703.98
	54"(1372mm)	25.75"(654mm)/25.75"(654mm)	UQFS-1654-WW	B	NA	6741.76	6751.66	6954.54	6964.44
	60"(1524mm)	28.75"(730mm)/28.75"(730mm)	UQFS-1660-WW	B	NA	7013.32	7023.22	7240.95	7250.85
	66"(1676mm)	31.75"(806mm)/31.75"(806mm)	UQFS-1666-WW	B	NA	7264.12	7274.02	7506.60	7516.50
	72"(1829mm)	34.75"(883mm)/34.75"(883mm)	UQFS-1672-WW	B	NA	7514.92	7524.82	7772.25	7782.15
	80"(2032mm)	38.75"(984mm)/38.75"(984mm)	UQFS-1680-WW	B	NA	7849.32	7859.22	8126.45	8136.35
	84"(2134mm)	40.75"(1035mm)/40.75"(1035mm)	UQFS-1684-WW	B	NA	8016.52	8026.42	8303.55	8313.45
	96"(2438mm)	46.75"(1187mm)/46.75"(1187mm)	UQFS-1696-WW	B	NA	8607.18	8617.08	8923.91	8933.81

Upper Storage

Storage Box

Outside Width	Number	① ②	Case Wood A		Door Glass C		Door Glass F		Door Acrylic	
			Door Glass A		Trim		Trim		Trim	
			A	B	A	B	A	B	A	B
With Glass or Acrylic Doors/16.5"(419mm) Outside Height										
30"(762mm)	UQFS-1630-WG	B NA	\$ 5970.70	\$5980.60	\$ 7311.41	\$ 7321.31	\$ 8284.18	\$ 8294.08	\$ 5970.70	\$5980.60
36"(914mm)	UQFS-1636-WG	B NA	6211.93	6221.83	7670.06	7679.96	8719.15	8729.05	6123.94	6133.84
40"(1016mm)	UQFS-1640-WG	B NA	6372.75	6382.65	7909.16	7919.06	9009.13	9019.03	6226.10	6236.00
42"(1067mm)	UQFS-1642-WG	B NA	6453.16	6463.06	8028.71	8038.61	9154.12	9164.02	6277.18	6287.08
48"(1219mm)	UQFS-1648-WG	B NA	6694.39	6704.29	8387.36	8397.26	9589.09	9598.99	6430.42	6440.32
54"(1372mm)	UQFS-1654-WG	B NA	6935.62	6945.52	8746.01	8755.91	10024.06	10033.96	6583.66	6593.56
60"(1524mm)	UQFS-1660-WG	B NA	7202.80	7212.70	9130.61	9140.51	10484.98	10494.88	6762.85	6772.75
66"(1676mm)	UQFS-1666-WG	B NA	7449.22	7459.12	9494.45	9504.35	10925.14	10935.04	6921.28	6931.18
72"(1829mm)	UQFS-1672-WG	B NA	7695.64	7705.54	9858.29	9868.19	11365.30	11375.20	7198.65	7208.55
80"(2032mm)	UQFS-1680-WG	B NA	8024.20	8034.10	10343.41	10353.31	11952.18	11962.08	7290.95	7300.85
84"(2134mm)	UQFS-1684-WG	B NA	8188.48	8198.38	10585.97	10595.87	12245.62	12255.52	7396.57	7406.47
96"(2438mm)	UQFS-1696-WG	B NA	8770.38	8780.28	11402.71	11412.61	13215.00	13224.90	7802.49	7812.39

Refer to page 273 for inside width dimensions.

Outside Width	Number	① ②	Case Wood B		Door Glass C		Door Glass F		Door Acrylic	
			Door Glass A		Trim		Trim		Trim	
			A	B	A	B	A	B	A	B
With Glass or Acrylic Doors/16.5"(419mm) Outside Height										
30"(762mm)	UQFS-1630-WG	B NA	\$ 6226.49	\$ 6236.39	\$ 7567.20	\$ 7577.10	\$ 8539.97	\$ 8549.87	\$ 6226.49	\$ 6236.39
36"(914mm)	UQFS-1636-WG	B NA	6480.89	6490.79	7939.02	7948.92	8988.11	8998.01	6392.90	6402.80
40"(1016mm)	UQFS-1640-WG	B NA	6650.49	6660.39	8186.90	8196.80	9286.87	9296.77	6503.84	6513.74
42"(1067mm)	UQFS-1642-WG	B NA	6735.29	6745.19	8310.84	8320.74	9436.25	9446.15	6559.31	6569.21
48"(1219mm)	UQFS-1648-WG	B NA	6989.69	6999.59	8682.66	8692.56	9884.39	9894.29	6725.72	6735.62
54"(1372mm)	UQFS-1654-WG	B NA	7244.09	7253.99	9054.48	9064.38	10332.53	10342.43	6892.13	6902.03
60"(1524mm)	UQFS-1660-WG	B NA	7524.44	7534.34	9452.25	9462.15	10806.62	10816.52	7084.49	7094.39
66"(1676mm)	UQFS-1666-WG	B NA	7784.03	7793.93	9829.26	9839.16	11259.95	11269.85	7256.09	7265.99
72"(1829mm)	UQFS-1672-WG	B NA	8043.62	8053.52	10206.27	10216.17	11713.28	11723.18	7427.69	7437.59
80"(2032mm)	UQFS-1680-WG	B NA	8389.74	8399.64	10708.95	10718.85	12317.72	12327.62	7656.49	7666.39
84"(2134mm)	UQFS-1684-WG	B NA	8562.80	8572.70	10960.29	10970.19	12619.94	12629.84	7770.89	7780.79
96"(2438mm)	UQFS-1696-WG	B NA	9171.04	9180.94	11803.37	11813.27	13615.66	13625.56	8203.15	8213.05

Refer to page 273 for inside width dimensions.

Storage Box Accessories

Ganging Flat Bracket for Storage Box

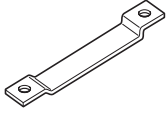

ZUUG
Class CA - GSA Open Market

Feature

- Includes one bracket and attachment hardware.

Specification Tips

- Provides additional stability in unbalanced panel. Applications with adjacent storage boxes.
- Required for all adjacent storage boxes in an unbalanced condition.

To Order, Specify:

- 1) Product number.
- 2) Trim color.

	Number	Trim	
		A	B
	ZUUG-0000	\$78.89	\$84.81

Upper Storage — Adaptable

Overhead Storage Unit

Standard Mount

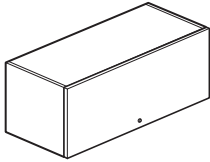

UZFS-PM

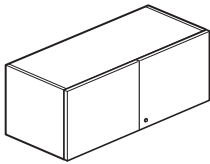

UZKS-PM

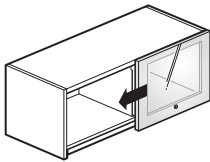

UZHF-QM
Class CA

Features

- Includes door front without lock, top shelf, bottom shelf with back stop, end panels, and hardware. Optional locks available.
- Door available in painted, high-pressure laminate (HPL), translucent or wood.
- Inside dimensions:
–Height: 12.75”(324mm)
–Depth: 13.25”(337mm)
- Locks are available in black or chrome.
- For lock options, refer to Lock Program section of the Accessories Price List.
- Accepts separately specified task lights.
- Safety interlock prevents dislodgement from panel component slots.
- Flipper door stores on top of unit.
- Flipper Door - 66”(1676mm) and 72”(1829mm)W units have two doors, one lock per door if locking option is specified.
- Cabinet Door - 24”(610mm)-42”(1067mm)W units have two cabinet doors with one lock if locking option is specified.
– 48”(1219mm)-72”(1829mm)W units have four cabinet doors with two locks if locking option is specified.
- Single Slider Door - Door is half the width of the unit.
- Shipped unassembled.

Specification Tips

- To be installed in connector slots on same size panel or on a maximum of two panel frames that equal the width of the storage unit.
- Specify separate shelf gang clip for unbalanced configurations with greater than one row of overhead storage units.
- Units cannot be retrofitted with different door style; i.e., flipper doors cannot be changed to cabinet doors.
- Doors cannot be retrofitted with locks.
- Standard mount overhead storage unit cannot be retrofitted to up mount overhead storage unit.
- Cannot be used on top of slat tile.
- Flipper doors can be field retrofitted with slow close mechanism from eParts.

To Order, Specify:

1) Product number, including:

1 Locking Option:

- N** Non-locking
- L** Locking (add **\$31.53** list)

2 Close Option: (Flipper door only)

- S** Slow close 24”(610mm)-60”(1524mm)W units (add **\$516.39** list)
66”(1676mm) and
72”(1829mm)W units (add **\$1032.78** list)

□ No specification required for standard close.

2) Trim color for shelf and end panels.

3) Door surface options:

Painted:

–Trim color

Laminate:

–Laminate surface color
–Edgeband trim color

Translucent:

–Translucent color

Wood:

–Wood finish color

4) Trim color for lock housing (if applicable).

Upper Storage — Adaptable

Overhead Storage Unit

Height	Depth	Width	Painted Flipper Door Number ①②	Trim		Trim	
				A	B	A	B
Painted							
16"(406mm)	14"(356mm)	24"(610mm)	UZFS-1624-PM	\$1098.32	\$1104.24	\$1114.09	\$1120.01
		30"(762mm)	UZFS-1630-PM	1148.96	1155.88	1166.68	1173.60
		36"(914mm)	UZFS-1636-PM	1199.60	1207.52	1219.27	1227.19
		42"(1067mm)	UZFS-1642-PM	1250.24	1259.16	1271.86	1280.78
		48"(1219mm)	UZFS-1648-PM	1300.88	1310.80	1324.45	1334.37
		54"(1372mm)	UZFS-1654-PM	1351.52	1362.44	1377.04	1387.96
		60"(1524mm)	UZFS-1660-PM	1518.43	1530.35	1545.90	1557.82
		66"(1676mm)	UZFS-1666-PM	1827.26	1840.18	1856.68	1869.60
		72"(1829mm)	UZFS-1672-PM	2153.85	2167.77	2185.22	2199.14

Height	Depth	Width	Painted Cabinet Door Number ①	Trim		Trim	
				A	B	A	B
16"(406mm)	14"(356mm)	24"(610mm)	UZKS-1624-PM	\$1830.13	\$1836.05	\$1845.90	\$1851.82
		30"(762mm)	UZKS-1630-PM	1880.77	1887.69	1898.49	1905.41
		36"(914mm)	UZKS-1636-PM	1931.41	1939.33	1951.08	1959.00
		42"(1067mm)	UZKS-1642-PM	1982.05	1990.97	2003.67	2012.59
		48"(1219mm)	UZKS-1648-PM	2103.05	2112.97	2126.62	2136.54
		54"(1372mm)	UZKS-1654-PM	2286.34	2297.26	2311.86	2322.78
		60"(1524mm)	UZKS-1660-PM	2498.55	2510.47	2526.02	2537.94
		66"(1676mm)	UZKS-1666-PM	3014.36	3027.28	3043.78	3056.70
		72"(1829mm)	UZKS-1672-PM	3478.94	3492.86	3510.31	3524.23

Height	Depth	Width	Painted Single Slider Door Number ①	Trim		Trim	
				A	B	A	B
16"(406mm)	14"(356mm)	24"(610mm)	UZHS-1624-PM	\$1098.32	\$1104.24	\$1114.09	\$1120.01
		30"(762mm)	UZHS-1630-PM	1148.96	1155.88	1166.68	1173.60
		36"(914mm)	UZHS-1636-PM	1199.60	1207.52	1219.27	1227.19
		42"(1067mm)	UZHS-1642-PM	1250.24	1259.16	1271.86	1280.78
		48"(1219mm)	UZHS-1648-PM	1300.88	1310.80	1324.45	1334.37
		54"(1372mm)	UZHS-1654-PM	1351.52	1362.44	1377.04	1387.96
		60"(1524mm)	UZHS-1660-PM	1518.43	1530.35	1545.90	1557.82
		66"(1676mm)	UZHS-1666-PM	1827.26	1840.18	1856.68	1869.60
		72"(1829mm)	UZHS-1672-PM	2153.85	2167.77	2185.22	2199.14

Upper Storage — Adaptable

Overhead Storage Unit

Height	Depth	Width	Laminate Flipper Door Number ①②	HPL A Trim		HPL B Trim	
				A	B	A	B
Laminate							
16"(406mm)	14"(356mm)	24"(610mm)	UZFS-1624-LM	\$1492.68	\$1508.45	\$1522.27	\$1538.04
		30"(762mm)	UZFS-1630-LM	1580.58	1598.30	1610.17	1627.89
		36"(914mm)	UZFS-1636-LM	1668.48	1688.15	1698.07	1717.74
		42"(1067mm)	UZFS-1642-LM	1756.38	1778.00	1785.97	1807.59
		48"(1219mm)	UZFS-1648-LM	1844.28	1867.85	1873.87	1897.44
		54"(1372mm)	UZFS-1654-LM	1932.18	1957.70	1961.77	1987.29
		60"(1524mm)	UZFS-1660-LM	2140.33	2167.80	2169.92	2197.39
		66"(1676mm)	UZFS-1666-LM	2594.77	2624.19	2624.36	2653.78
		72"(1829mm)	UZFS-1672-LM	3051.26	3082.63	3080.85	3112.22

Height	Depth	Width	Laminate Cabinet Door Number ①	HPL A Trim		HPL B Trim	
				A	B	A	B
16"(406mm)	14"(356mm)	24"(610mm)	UZKS-1624-LM	\$2540.81	\$2556.58	\$2570.40	\$2586.17
		30"(762mm)	UZKS-1630-LM	2628.71	2646.43	2658.30	2676.02
		36"(914mm)	UZKS-1636-LM	2716.61	2736.28	2746.20	2765.87
		42"(1067mm)	UZKS-1642-LM	2804.51	2826.13	2834.10	2855.72
		48"(1219mm)	UZKS-1648-LM	2930.34	2953.91	2959.93	2983.50
		54"(1372mm)	UZKS-1654-LM	3214.85	3240.37	3244.44	3269.96
		60"(1524mm)	UZKS-1660-LM	3519.56	3547.03	3549.15	3576.62
		66"(1676mm)	UZKS-1666-LM	4210.54	4239.96	4240.13	4269.55
		72"(1829mm)	UZKS-1672-LM	4897.65	4929.02	4927.24	4958.61

Height	Depth	Width	Laminate Single Slider Door Number ①	HPL A Trim		HPL B Trim	
				A	B	A	B
16"(406mm)	14"(356mm)	24"(610mm)	UZHS-1624-LM	\$1492.68	\$1508.45	\$1522.27	\$1538.04
		30"(762mm)	UZHS-1630-LM	1580.58	1598.30	1610.17	1627.89
		36"(914mm)	UZHS-1636-LM	1668.48	1688.15	1698.07	1717.74
		42"(1067mm)	UZHS-1642-LM	1756.38	1778.00	1785.97	1807.59
		48"(1219mm)	UZHS-1648-LM	1844.28	1867.85	1873.87	1897.44
		54"(1372mm)	UZHS-1654-LM	1932.18	1957.70	1961.77	1987.29
		60"(1524mm)	UZHS-1660-LM	2140.33	2167.80	2169.92	2197.39
		66"(1676mm)	UZHS-1666-LM	2594.77	2624.19	2624.36	2653.78
		72"(1829mm)	UZHS-1672-LM	3051.26	3082.63	3080.85	3112.22

Upper Storage — Adaptable

Overhead Storage Unit

Height	Depth	Width	Translucent	Trim	
			Flipper Door Number ①②	A	B
Translucent					
16"(406mm)	14"(356mm)	24"(610mm)	UZFF-1624-QM ■■	\$1720.90	\$ 1736.67
		30"(762mm)	UZFF-1630-QM ■■	1796.86	1814.58
		36"(914mm)	UZFF-1636-QM ■■	1872.82	1892.49
		42"(1067mm)	UZFF-1642-QM ■■	1948.78	1970.40
		48"(1219mm)	UZFF-1648-QM ■■	2024.74	2048.31
		54"(1372mm)	UZFF-1654-QM ■■	2100.70	2126.22
		60"(1524mm)	UZFF-1660-QM ■■	2348.13	2375.60
		66"(1676mm)	UZFF-1666-QM ■■	2875.41	2904.83
		72"(1829mm)	UZFF-1672-QM ■■	3272.67	3304.04

Height	Depth	Width	Translucent	Trim	
			Cabinet Door Number ①	A	B
16"(406mm)	14"(356mm)	24"(610mm)	UZKF-1624-QM ■	\$2769.03	\$2784.80
		30"(762mm)	UZKF-1630-QM ■	2874.48	2892.20
		36"(914mm)	UZKF-1636-QM ■	2979.93	2999.60
		42"(1067mm)	UZKF-1642-QM ■	3085.38	3107.00
		48"(1219mm)	UZKF-1648-QM ■	3225.99	3249.56
		54"(1372mm)	UZKF-1654-QM ■	3522.96	3548.48
		60"(1524mm)	UZKF-1660-QM ■	3838.09	3865.56
		66"(1676mm)	UZKF-1666-QM ■	4612.13	4641.55
		72"(1829mm)	UZKF-1672-QM ■	5323.45	5354.82

Height	Depth	Width	Translucent	Trim	
			Single Slider Door Number ①	A	B
16"(406mm)	14"(356mm)	24"(610mm)	UZHF-1624-QM ■	\$1720.90	\$ 1736.67
		30"(762mm)	UZHF-1630-QM ■	1796.86	1814.58
		36"(914mm)	UZHF-1636-QM ■	1872.82	1892.49
		42"(1067mm)	UZHF-1642-QM ■	1948.78	1970.40
		48"(1219mm)	UZHF-1648-QM ■	2024.74	2048.31
		54"(1372mm)	UZHF-1654-QM ■	2100.70	2126.22
		60"(1524mm)	UZHF-1660-QM ■	2348.13	2375.60
		66"(1676mm)	UZHF-1666-QM ■	2875.41	2904.83
		72"(1829mm)	UZHF-1672-QM ■	3272.67	3304.04

Upper Storage — Adaptable

Overhead Storage Unit

Height	Depth	Width	Wood Flipper Door Number ①②	Wood A Trim		Wood B Trim	
				A	B	A	B
Wood							
16"(406mm)	14"(356mm)	24"(610mm)	UZFS-1624-WM	\$ 2043.21	\$2058.98	\$ 2157.52	\$ 2173.29
		30"(762mm)	UZFS-1630-WM	2124.96	2142.68	2239.27	2256.99
		36"(914mm)	UZFS-1636-WM	2206.71	2226.38	2321.02	2340.69
		42"(1067mm)	UZFS-1642-WM	2288.46	2310.08	2402.77	2424.39
		48"(1219mm)	UZFS-1648-WM	2370.21	2393.78	2484.52	2508.09
		54"(1372mm)	UZFS-1654-WM	2451.96	2477.48	2566.27	2591.79
		60"(1524mm)	UZFS-1660-WM	2774.15	2801.62	2888.46	2915.93
		66"(1676mm)	UZFS-1666-WM	3261.92	3291.34	3376.23	3405.65
		72"(1829mm)	UZFS-1672-WM	3789.13	3820.50	3903.44	3934.81

Height	Depth	Width	Wood Cabinet Door Number ①	Wood A Trim		Wood B Trim	
				A	B	A	B
16"(406mm)	14"(356mm)	24"(610mm)	UZKS-1624-WM	\$ 3179.91	\$ 3195.68	\$3294.22	\$3309.99
		30"(762mm)	UZKS-1630-WM	3273.54	3291.26	3387.85	3405.57
		36"(914mm)	UZKS-1636-WM	3367.17	3386.84	3481.48	3501.15
		42"(1067mm)	UZKS-1642-WM	3460.80	3482.42	3575.11	3596.73
		48"(1219mm)	UZKS-1648-WM	3591.64	3615.21	3705.95	3729.52
		54"(1372mm)	UZKS-1654-WM	3916.11	3941.63	4030.42	4055.94
		60"(1524mm)	UZKS-1660-WM	4261.55	4289.02	4375.86	4403.33
		66"(1676mm)	UZKS-1666-WM	5051.37	5080.79	5165.68	5195.10
		72"(1829mm)	UZKS-1672-WM	5834.90	5866.27	5949.21	5980.58

Height	Depth	Width	Wood Single Slider Door Number ①	Wood A Trim		Wood B Trim	
				A	B	A	B
16"(406mm)	14"(356mm)	24"(610mm)	UZHS-1624-WM	\$ 2043.21	\$2058.98	\$ 2157.52	\$ 2173.29
		30"(762mm)	UZHS-1630-WM	2124.96	2142.68	2239.27	2256.99
		36"(914mm)	UZHS-1636-WM	2206.71	2226.38	2321.02	2340.69
		42"(1067mm)	UZHS-1642-WM	2288.46	2310.08	2402.77	2424.39
		48"(1219mm)	UZHS-1648-WM	2370.21	2393.78	2484.52	2508.09
		54"(1372mm)	UZHS-1654-WM	2451.96	2477.48	2566.27	2591.79
		60"(1524mm)	UZHS-1660-WM	2774.15	2801.62	2888.46	2915.93
		66"(1676mm)	UZHS-1666-WM	3261.92	3291.34	3376.23	3405.65
		72"(1829mm)	UZHS-1672-WM	3789.13	3820.50	3903.44	3934.81

Upper Storage — Adaptable

Overhead Storage Unit

Up Mount

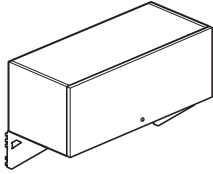

UZGS-PM

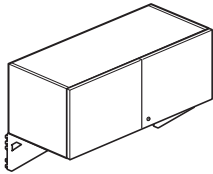

UZLS-PM

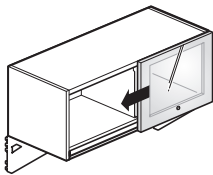

UZJS-PM
Class CA

Features

- Includes door front without lock, top shelf, bottom shelf with full back, end panels, mounting brackets and hardware. Optional locks available.
- Door available in painted, high-pressure laminate (HPL), translucent or wood.
- Inside dimensions:
–Height: 12.75”(324mm)
–Depth: 13.25”(337mm)
- Up-Mount brackets are color-matched to case.
- Locks are available in black or chrome.
- For lock options, refer to Lock Program section of the Accessories Price List.
- Accepts separately specified task lights.
- Safety interlock prevents dislodgement from panel component slots.
- Flipper door stores on top of unit.
- Cabinet Door - 24”(610mm)-42”(1067mm)W units have two cabinet doors with one lock if locking option is specified.
– 48”(1219mm)W units have four cabinet doors with two locks if locking option is specified.
- Single Slider Door - Door is half the width of the unit.
- Doors shipped separate - ships unassembled.

Specification Tips

- To be installed in connector slots on same size panel or on a maximum of two panel frames that equal the width of the storage unit.
- Specify separate shelf gang clip for unbalanced configurations with greater than one row of overhead storage units.
- Doors cannot be retrofitted with locks.
- Up-mount overhead storage unit cannot be retrofitted to standard mount overhead storage unit.
- Recommended for single row application.
- Recommended for use with 50”(1270mm) or 58”(1473mm)H panel configurations.
- Using up mount overheads limits allowable panel runs to 8 feet maximum and requires worksurfaces use side-mount brackets, worksurface support panels or other form of floor support. (Fully cantilevered worksurfaces are not allowed). Return panels on each end must equal height of panel run and depth of worksurface.
- Up-mount overhead storage cannot be installed above an external mount slat tile, tackboard, markerboard, glass stack or glass panel.
- Flipper doors can be field retrofitted with slow close mechanism from eParts.

To Order, Specify:

1) Product number, including:

1 Locking Option:

- N** Non-locking
- L** Locking (add **\$31.53** list)

2 Close Option: (Flipper door only)

- S** Slow close (add **\$516.39** list)
- No specification required for standard close.

2) Trim color for shelf and end panels.

3) Door surface options:

Painted:

- Trim color

Laminate:

- Laminate surface color
- Edgeband trim color

Translucent:

- Translucent color

Wood:

- Wood finish color

4) Trim color for lock housing (if applicable).

Upper Storage — Adaptable

Overhead Storage Unit

Height	Depth	Width	Painted Flipper Door Number ①②	Trim A	Trim B	Trim A	Trim B
				A	B	A	B
Painted							
16"(406mm)	14"(356mm)	24"(610mm)	UZGS-1624-PM	\$1535.02	\$1540.94	\$1550.79	\$1556.71
		30"(762mm)	UZGS-1630-PM	1585.66	1592.58	1603.38	1610.30
		36"(914mm)	UZGS-1636-PM	1636.30	1644.22	1655.97	1663.89
		42"(1067mm)	UZGS-1642-PM	1686.94	1695.86	1708.56	1717.48
		48"(1219mm)	UZGS-1648-PM	1737.58	1747.50	1761.15	1771.07

Height	Depth	Width	Painted Cabinet Door Number ①	Trim A	Trim B	Trim A	Trim B
				A	B	A	B
16"(406mm)	14"(356mm)	24"(610mm)	UZLS-1624-PM	\$2593.81	\$2599.73	\$2609.58	\$2615.50
		30"(762mm)	UZLS-1630-PM	2644.45	2651.37	2662.17	2669.09
		36"(914mm)	UZLS-1636-PM	2695.09	2703.01	2714.76	2722.68
		42"(1067mm)	UZLS-1642-PM	2745.73	2754.65	2767.35	2776.27
		48"(1219mm)	UZLS-1648-PM	2866.73	2876.65	2890.30	2900.22

Height	Depth	Width	Painted Single Slider Door Number ①	Trim A	Trim B	Trim A	Trim B
				A	B	A	B
16"(406mm)	14"(356mm)	24"(610mm)	UZJS-1624-PM	\$1535.02	\$1540.94	\$1550.79	\$1556.71
		30"(762mm)	UZJS-1630-PM	1585.66	1592.58	1603.38	1610.30
		36"(914mm)	UZJS-1636-PM	1636.30	1644.22	1655.97	1663.89
		42"(1067mm)	UZJS-1642-PM	1686.94	1695.86	1708.56	1717.48
		48"(1219mm)	UZJS-1648-PM	1737.58	1747.50	1761.15	1771.07

Upper Storage — Adaptable

Overhead Storage Unit

Height	Depth	Width	Laminate Flipper Door Number ①②	HPL A Trim		HPL B Trim	
				A	B	A	B
Laminate							
16"(406mm)	14"(356mm)	24"(610mm)	UZGS-1624-LM ■■	\$ 2119.77	\$ 2135.54	\$ 2149.36	\$ 2165.13
		30"(762mm)	UZGS-1630-LM ■■	2207.67	2225.39	2237.26	2254.98
		36"(914mm)	UZGS-1636-LM ■■	2295.57	2315.24	2325.16	2344.83
		42"(1067mm)	UZGS-1642-LM ■■	2383.47	2405.09	2413.06	2434.68
		48"(1219mm)	UZGS-1648-LM ■■	2471.37	2494.94	2500.96	2524.53

Height	Depth	Width	Laminate Cabinet Door Number ①	HPL A Trim		HPL B Trim	
				A	B	A	B
16"(406mm)	14"(356mm)	24"(610mm)	UZLS-1624-LM ■	\$3633.54	\$ 3649.31	\$ 3663.13	\$3678.90
		30"(762mm)	UZLS-1630-LM ■	3721.44	3739.16	3751.03	3768.75
		36"(914mm)	UZLS-1636-LM ■	3809.34	3829.01	3838.93	3858.60
		42"(1067mm)	UZLS-1642-LM ■	3897.24	3918.86	3926.83	3948.45
		48"(1219mm)	UZLS-1648-LM ■	4023.07	4046.64	4052.66	4076.23

Height	Depth	Width	Laminate Single Slider Door Number ①	HPL A Trim		HPL B Trim	
				A	B	A	B
16"(406mm)	14"(356mm)	24"(610mm)	UZJS-1624-LM ■	\$ 2119.77	\$ 2135.54	\$ 2149.36	\$ 2165.13
		30"(762mm)	UZJS-1630-LM ■	2207.67	2225.39	2237.26	2254.98
		36"(914mm)	UZJS-1636-LM ■	2295.57	2315.24	2325.16	2344.83
		42"(1067mm)	UZJS-1642-LM ■	2383.47	2405.09	2413.06	2434.68
		48"(1219mm)	UZJS-1648-LM ■	2471.37	2494.94	2500.96	2524.53

Upper Storage — Adaptable

Overhead Storage Unit

Height	Depth	Width	Translucent Flipper Door		
			Number ①②	Trim A B	
Translucent					
16"(406mm)	14"(356mm)	24"(610mm)	UZGF-1624-QM	\$2407.97	\$2423.74
		30"(762mm)	UZGF-1630-QM	2483.93	2501.65
		36"(914mm)	UZGF-1636-QM	2559.89	2579.56
		42"(1067mm)	UZGF-1642-QM	2635.85	2657.47
		48"(1219mm)	UZGF-1648-QM	2711.81	2735.38

Height	Depth	Width	Translucent Cabinet Door		
			Number ①	Trim A B	
16"(406mm)	14"(356mm)	24"(610mm)	UZLF-1624-QM	\$3948.65	\$3964.42
		30"(762mm)	UZLF-1630-QM	4054.10	4071.82
		36"(914mm)	UZLF-1636-QM	4159.55	4179.22
		42"(1067mm)	UZLF-1642-QM	4265.00	4286.62
		48"(1219mm)	UZLF-1648-QM	4405.61	4429.18

Height	Depth	Width	Translucent Single Slider Door		
			Number ①	Trim A B	
16"(406mm)	14"(356mm)	24"(610mm)	UZJF-1624-QM	\$2407.97	\$2423.74
		30"(762mm)	UZJF-1630-QM	2483.93	2501.65
		36"(914mm)	UZJF-1636-QM	2559.89	2579.56
		42"(1067mm)	UZJF-1642-QM	2635.85	2657.47
		48"(1219mm)	UZJF-1648-QM	2711.81	2735.38

Upper Storage — Adaptable

Overhead Storage Unit

Height	Depth	Width	Wood Flipper Door Number ①②	Wood A Trim		Wood B Trim	
				A	B	A	B
Wood							
16"(406mm)	14"(356mm)	24"(610mm)	UZGS-1624-WM	\$2699.26	\$ 2715.03	\$ 2813.57	\$ 2829.34
		30"(762mm)	UZGS-1630-WM	2781.01	2798.73	2895.32	2913.04
		36"(914mm)	UZGS-1636-WM	2862.76	2882.43	2977.07	2996.74
		42"(1067mm)	UZGS-1642-WM	2944.51	2966.13	3058.82	3080.44
		48"(1219mm)	UZGS-1648-WM	3026.26	3049.83	3140.57	3164.14

Height	Depth	Width	Wood Cabinet Door Number ①	Wood A Trim		Wood B Trim	
				A	B	A	B
16"(406mm)	14"(356mm)	24"(610mm)	UZLS-1624-WM	\$ 4425.74	\$ 4441.51	\$4540.05	\$4555.82
		30"(762mm)	UZLS-1630-WM	4519.37	4537.09	4633.68	4651.40
		36"(914mm)	UZLS-1636-WM	4613.00	4632.67	4727.31	4746.98
		42"(1067mm)	UZLS-1642-WM	4706.63	4728.25	4820.94	4842.56
		48"(1219mm)	UZLS-1648-WM	4837.47	4861.04	4951.78	4975.35

Height	Depth	Width	Wood Single Slider Door Number ①	Wood A Trim		Wood B Trim	
				A	B	A	B
16"(406mm)	14"(356mm)	24"(610mm)	UZJS-1624-WM	\$2699.26	\$ 2715.03	\$ 2813.57	\$ 2829.34
		30"(762mm)	UZJS-1630-WM	2781.01	2798.73	2895.32	2913.04
		36"(914mm)	UZJS-1636-WM	2862.76	2882.43	2977.07	2996.74
		42"(1067mm)	UZJS-1642-WM	2944.51	2966.13	3058.82	3080.44
		48"(1219mm)	UZJS-1648-WM	3026.26	3049.83	3140.57	3164.14

Upper Storage — Adaptable

Open Shelf Standard Mount

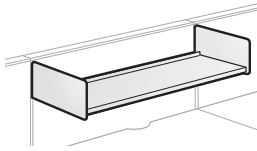

UZSN
Class CA

Features

- Includes shelf with back stop, end panels and hardware.
- Accepts separately specified task lights.
- Safety interlock prevents dislodgment from panel connector slots.
- Shelf thickness is 2"(51mm).
- Shipped unassembled.

Specification Tips

- Specify separate shelf gang clip for unbalanced configurations with greater than one row of shelves.
- To be installed in component mounting rails on same size panel or on a maximum of two panel frames that equals the shelf width.

To Order, Specify:

- 1) Product number.
- 2) Trim color.

Height	Depth	Width	Number	Trim	
				A	B
8"(203mm)	14"(356mm)	24"(610mm)	UZSN-0824-PM	\$372.87	\$ 391.56
		30"(762mm)	UZSN-0830-PM	386.19	409.53
		36"(914mm)	UZSN-0836-PM	399.51	427.50
		42"(1067mm)	UZSN-0842-PM	412.83	445.47
		48"(1219mm)	UZSN-0848-PM	426.15	463.44
		54"(1372mm)	UZSN-0854-PM	439.47	481.41
		60"(1524mm)	UZSN-0860-PM	452.79	499.38
		66"(1676mm)	UZSN-0866-PM	466.11	517.35
		72"(1829mm)	UZSN-0872-PM	479.43	535.32

Shelf Divider

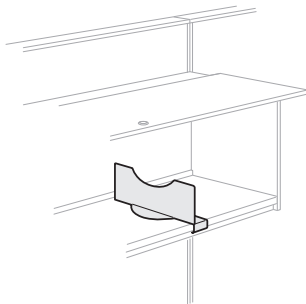

NADR-8
Class CA

Features

- To be used to divide space laterally on overhead storage units and open shelves.
- Includes box of eight shelf dividers.
- May be used on all Compose shelves or standard mount or up-mount overhead storage units.

To Order, Specify:

- 1) Product number.
- 2) Trim color.

Height	Depth	Width	Number	Trim	
				A	B
4"(102mm)	13.25"(337mm)	1.75"(44mm)	NADR-8	\$445.87	\$469.99

Overhead Storage Unit / Shelf Gang Clip

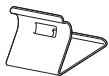

NUB-1
Class CA

Features

- Includes one ganging clip.
- Provides additional stability in unbalanced panel configurations with adjacent shelves and overheads.
- Required for all adjacent shelves and unbalanced panel configurations.
- Standard in black finish.

To Order, Specify:

- 1) Product number.
(No finish specification required.)

Number	Price
NUB-1	\$76.43

Wall Mount Components

Overhead Storage Unit

Wall Mount

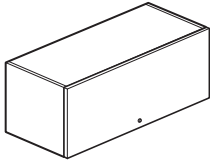

UUFS-PW

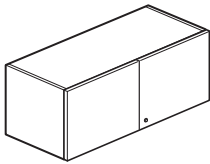

UUKS-PW

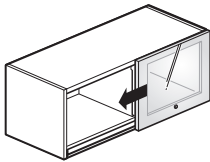

UUHF-QW
Class CA

Features

- Includes door front with lock option, top shelf, bottom shelf with back stop, end panels, mounting bar and hardware. Optional locks and non-structural back are available.
- Door available in painted, high-pressure laminate (HPL), translucent or wood.
- Inside dimensions:
–Height: 12.75”(324mm)
–Depth: 13.25”(337mm)
- Locks are available in black or chrome.
- For lock options, refer to Lock Program section of the Accessories Price List.
- Accepts separately specified task lights.
- Safety interlock prevents dislodgement from wall.
- Flipper Door - 66”(1676mm) and 72”(1829mm)W units have two doors, one lock per door if locking option is specified.
- Flipper door stores on top of unit.
- Cabinet Door - 24”(610mm)-42”(1067mm)W units have two cabinet doors with one lock if locking option is specified.
– 48”(1219mm)-72”(1829mm)W units have four cabinet doors with two locks if locking option is specified.
- Single Slider Door - Door is half the width of the unit.
- Shipped unassembled.

Specification Tips

- Doors cannot be retrofitted with locks.
- Must be properly anchored to a structural wall.
- Anchors are not provided, must be field supplied.
- Flipper doors can be field retrofitted with slow close mechanism from eParts.

To Order, Specify:

1) Product number, including:

1 Locking Option:

- N** Non-locking
- L** Locking (add **\$31.53** list)

2 Close Option: (Flipper door only)

- S** Slow close 24”(610mm)-60”(1524mm)W units (add **\$516.39** list)
66”(1676mm) and 72”(1829mm)W units (add **\$1032.78** list)

□ No specification required for standard close.

2) Trim color for shelf and end panels.

3) Door surface options:

Painted:

–Trim color

Laminate:

–Laminate surface color
–Edgeband trim color

Translucent:

–Translucent color

Wood:

–Wood finish color

4) Trim color for lock housing (if applicable).

Wall Mount Components

Overhead Storage Unit

Height	Depth	Width	Painted Flipper Door Number ①②	Trim A		Trim B	
				Trim A	B	Trim A	B
Painted							
16"(406mm)	14"(356mm)	24"(610mm)	UUFS-1624-PW	\$ 1183.15	\$ 1189.07	\$ 1198.92	\$1204.84
		30"(762mm)	UUFS-1630-PW	1233.79	1240.71	1251.51	1258.43
		36"(914mm)	UUFS-1636-PW	1284.43	1292.35	1304.10	1312.02
		42"(1067mm)	UUFS-1642-PW	1335.07	1343.99	1356.69	1365.61
		48"(1219mm)	UUFS-1648-PW	1385.71	1395.63	1409.28	1419.20
		54"(1372mm)	UUFS-1654-PW	1436.35	1447.27	1461.87	1472.79
		60"(1524mm)	UUFS-1660-PW	1603.26	1615.18	1630.73	1642.65
		66"(1676mm)	UUFS-1666-PW	1912.09	1925.01	1941.51	1954.43
		72"(1829mm)	UUFS-1672-PW	2238.68	2252.60	2270.05	2283.97

Height	Depth	Width	Painted Cabinet Door Number ①	Trim A		Trim B	
				Trim A	B	Trim A	B
16"(406mm)	14"(356mm)	24"(610mm)	UUKS-1624-PW	\$ 1914.96	\$ 1920.88	\$ 1930.73	\$ 1936.65
		30"(762mm)	UUKS-1630-PW	1965.60	1972.52	1983.32	1990.24
		36"(914mm)	UUKS-1636-PW	2016.24	2024.16	2035.91	2043.83
		42"(1067mm)	UUKS-1642-PW	2066.88	2075.80	2088.50	2097.42
		48"(1219mm)	UUKS-1648-PW	2187.88	2197.80	2211.45	2221.37
		54"(1372mm)	UUKS-1654-PW	2371.17	2382.09	2396.69	2407.61
		60"(1524mm)	UUKS-1660-PW	2583.38	2595.30	2610.85	2622.77
		66"(1676mm)	UUKS-1666-PW	3099.19	3112.11	3128.61	3141.53
		72"(1829mm)	UUKS-1672-PW	3563.77	3577.69	3595.14	3609.06

Height	Depth	Width	Painted Single Slider Door Number ①	Trim A		Trim B	
				Trim A	B	Trim A	B
16"(406mm)	14"(356mm)	24"(610mm)	UUHS-1624-PW	\$ 1183.15	\$ 1189.07	\$ 1198.92	\$1204.84
		30"(762mm)	UUHS-1630-PW	1233.79	1240.71	1251.51	1258.43
		36"(914mm)	UUHS-1636-PW	1284.43	1292.35	1304.10	1312.02
		42"(1067mm)	UUHS-1642-PW	1335.07	1343.99	1356.69	1365.61
		48"(1219mm)	UUHS-1648-PW	1385.71	1395.63	1409.28	1419.20
		54"(1372mm)	UUHS-1654-PW	1436.35	1447.27	1461.87	1472.79
		60"(1524mm)	UUHS-1660-PW	1603.26	1615.18	1630.73	1642.65
		66"(1676mm)	UUHS-1666-PW	1912.09	1925.01	1941.51	1954.43
		72"(1829mm)	UUHS-1672-PW	2238.68	2252.60	2270.05	2283.97

Wall Mount Components

Overhead Storage Unit

Height	Depth	Width	Laminate Flipper Door Number ①②	HPL A Trim		HPL B Trim	
				A	B	A	B
Laminate							
16"(406mm)	14"(356mm)	24"(610mm)	UUFS-1624-LW	\$ 1772.10	\$ 1787.87	\$ 1801.69	\$ 1817.46
		30"(762mm)	UUFS-1630-LW	1860.00	1877.72	1889.59	1907.31
		36"(914mm)	UUFS-1636-LW	1947.90	1967.57	1977.49	1997.16
		42"(1067mm)	UUFS-1642-LW	2035.80	2057.42	2065.39	2087.01
		48"(1219mm)	UUFS-1648-LW	2123.70	2147.27	2153.29	2176.86
		54"(1372mm)	UUFS-1654-LW	2211.60	2237.12	2241.19	2266.71
		60"(1524mm)	UUFS-1660-LW	2419.75	2447.22	2449.34	2476.81
		66"(1676mm)	UUFS-1666-LW	2874.19	2903.61	2903.78	2933.20
		72"(1829mm)	UUFS-1672-LW	3330.68	3362.05	3360.27	3391.64

Height	Depth	Width	Laminate Cabinet Door Number ①	HPL A Trim		HPL B Trim	
				A	B	A	B
16"(406mm)	14"(356mm)	24"(610mm)	UUKS-1624-LW	\$ 2820.23	\$ 2836.00	\$ 2849.82	\$ 2865.59
		30"(762mm)	UUKS-1630-LW	2908.13	2925.85	2937.72	2955.44
		36"(914mm)	UUKS-1636-LW	2996.03	3015.70	3025.62	3045.29
		42"(1067mm)	UUKS-1642-LW	3083.93	3105.55	3113.52	3135.14
		48"(1219mm)	UUKS-1648-LW	3209.76	3233.33	3239.35	3262.92
		54"(1372mm)	UUKS-1654-LW	3494.27	3519.79	3523.86	3549.38
		60"(1524mm)	UUKS-1660-LW	3798.98	3826.45	3828.57	3856.04
		66"(1676mm)	UUKS-1666-LW	4489.96	4519.38	4519.55	4548.97
		72"(1829mm)	UUKS-1672-LW	5177.07	5208.44	5206.66	5238.03

Height	Depth	Width	Laminate Single Slider Door Number ①	HPL A Trim		HPL B Trim	
				A	B	A	B
16"(406mm)	14"(356mm)	24"(610mm)	UUHS-1624-LW	\$ 1772.10	\$ 1787.87	\$ 1801.69	\$ 1817.46
		30"(762mm)	UUHS-1630-LW	1860.00	1877.72	1889.59	1907.31
		36"(914mm)	UUHS-1636-LW	1947.90	1967.57	1977.49	1997.16
		42"(1067mm)	UUHS-1642-LW	2035.80	2057.42	2065.39	2087.01
		48"(1219mm)	UUHS-1648-LW	2123.70	2147.27	2153.29	2176.86
		54"(1372mm)	UUHS-1654-LW	2211.60	2237.12	2241.19	2266.71
		60"(1524mm)	UUHS-1660-LW	2419.75	2447.22	2449.34	2476.81
		66"(1676mm)	UUHS-1666-LW	2874.19	2903.61	2903.78	2933.20
		72"(1829mm)	UUHS-1672-LW	3330.68	3362.05	3360.27	3391.64

Wall Mount Components

Overhead Storage Unit

Height	Depth	Width	Translucent	Trim	
			Flipper Door Number ①②	A	B
Translucent					
16"(406mm)	14"(356mm)	24"(610mm)	UUFF-1624-QW ■■	\$ 2091.43	\$ 2107.20
		30"(762mm)	UUFF-1630-QW ■■	2167.39	2185.11
		36"(914mm)	UUFF-1636-QW ■■	2243.35	2263.02
		42"(1067mm)	UUFF-1642-QW ■■	2319.31	2340.93
		48"(1219mm)	UUFF-1648-QW ■■	2395.27	2418.84
		54"(1372mm)	UUFF-1654-QW ■■	2471.23	2496.75
		60"(1524mm)	UUFF-1660-QW ■■	2718.66	2746.13
		66"(1676mm)	UUFF-1666-QW ■■	3245.94	3275.36
		72"(1829mm)	UUFF-1672-QW ■■	3643.20	3674.57

Height	Depth	Width	Translucent	Trim	
			Cabinet Door Number ①	A	B
16"(406mm)	14"(356mm)	24"(610mm)	UUKF-1624-QW ■	\$ 3139.56	\$ 3155.33
		30"(762mm)	UUKF-1630-QW ■	3245.01	3262.73
		36"(914mm)	UUKF-1636-QW ■	3350.46	3370.13
		42"(1067mm)	UUKF-1642-QW ■	3455.91	3477.53
		48"(1219mm)	UUKF-1648-QW ■	3596.52	3620.09
		54"(1372mm)	UUKF-1654-QW ■	3893.49	3919.01
		60"(1524mm)	UUKF-1660-QW ■	4208.62	4236.09
		66"(1676mm)	UUKF-1666-QW ■	4982.66	5012.08
		72"(1829mm)	UUKF-1672-QW ■	5693.98	5725.35

Height	Depth	Width	Translucent	Trim	
			Single Slider Door Number ①	A	B
16"(406mm)	14"(356mm)	24"(610mm)	UUHF-1624-QW ■	\$ 2091.43	\$ 2107.20
		30"(762mm)	UUHF-1630-QW ■	2167.39	2185.11
		36"(914mm)	UUHF-1636-QW ■	2243.35	2263.02
		42"(1067mm)	UUHF-1642-QW ■	2319.31	2340.93
		48"(1219mm)	UUHF-1648-QW ■	2395.27	2418.84
		54"(1372mm)	UUHF-1654-QW ■	2471.23	2496.75
		60"(1524mm)	UUHF-1660-QW ■	2718.66	2746.13
		66"(1676mm)	UUHF-1666-QW ■	3245.94	3275.36
		72"(1829mm)	UUHF-1672-QW ■	3643.20	3674.57

Wall Mount Components

Overhead Storage Unit

Height	Depth	Width	Wood Flipper Door Number ①②	Wood A Trim		Wood B Trim	
				A	B	A	B
Wood							
16"(406mm)	14"(356mm)	24"(610mm)	UUFS-1624-WW	\$ 2299.42	\$ 2315.19	\$ 2413.73	\$ 2429.50
		30"(762mm)	UUFS-1630-WW	2381.17	2398.89	2495.48	2513.20
		36"(914mm)	UUFS-1636-WW	2462.92	2482.59	2577.23	2596.90
		42"(1067mm)	UUFS-1642-WW	2544.67	2566.29	2658.98	2680.60
		48"(1219mm)	UUFS-1648-WW	2626.42	2649.99	2740.73	2764.30
		54"(1372mm)	UUFS-1654-WW	2708.17	2733.69	2822.48	2848.00
		60"(1524mm)	UUFS-1660-WW	3030.36	3057.83	3144.67	3172.14
		66"(1676mm)	UUFS-1666-WW	3518.13	3547.55	3632.44	3661.86
		72"(1829mm)	UUFS-1672-WW	4045.34	4076.71	4159.65	4191.02

Height	Depth	Width	Wood Cabinet Door Number ①	Wood A Trim		Wood B Trim	
				A	B	A	B
16"(406mm)	14"(356mm)	24"(610mm)	UUKS-1624-WW	\$3629.30	\$ 3645.07	\$ 3743.61	\$ 3759.38
		30"(762mm)	UUKS-1630-WW	3722.93	3740.65	3837.24	3854.96
		36"(914mm)	UUKS-1636-WW	3816.56	3836.23	3930.87	3950.54
		42"(1067mm)	UUKS-1642-WW	3910.19	3931.81	4024.50	4046.12
		48"(1219mm)	UUKS-1648-WW	4041.03	4064.60	4155.34	4178.91
		54"(1372mm)	UUKS-1654-WW	4365.50	4391.02	4479.81	4505.33
		60"(1524mm)	UUKS-1660-WW	4710.94	4738.41	4825.25	4852.72
		66"(1676mm)	UUKS-1666-WW	5500.76	5530.18	5615.07	5644.49
		72"(1829mm)	UUKS-1672-WW	6284.29	6315.66	6398.60	6429.97

Height	Depth	Width	Wood Single Slider Door Number ①	Wood A Trim		Wood B Trim	
				A	B	A	B
16"(406mm)	14"(356mm)	24"(610mm)	UUHS-1624-WW	\$ 2299.42	\$ 2315.19	\$ 2413.73	\$ 2429.50
		30"(762mm)	UUHS-1630-WW	2381.17	2398.89	2495.48	2513.20
		36"(914mm)	UUHS-1636-WW	2462.92	2482.59	2577.23	2596.90
		42"(1067mm)	UUHS-1642-WW	2544.67	2566.29	2658.98	2680.60
		48"(1219mm)	UUHS-1648-WW	2626.42	2649.99	2740.73	2764.30
		54"(1372mm)	UUHS-1654-WW	2708.17	2733.69	2822.48	2848.00
		60"(1524mm)	UUHS-1660-WW	3030.36	3057.83	3144.67	3172.14
		66"(1676mm)	UUHS-1666-WW	3518.13	3547.55	3632.44	3661.86
		72"(1829mm)	UUHS-1672-WW	4045.34	4076.71	4159.65	4191.02

Wall Mount Components

Wall Track

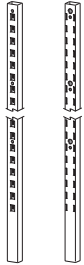

VZAT
Class CA

Features

- Includes one two-sided wall track and screws.
- One wall track will mount two adjacent components.
 - Side one will accommodate mounting of two components in a side-by-side shared condition.
 - Side two will accommodate mounting of one component.
- For attachment of the following components to structural walls:
 - panel-hung storage
 - tack strips, tackboards, markerboards
 - worksurface and supports

Specification Tips

- Mounting holes begin 0.5"(13mm) from the top and continue every 6"(152mm) on center. Wall track is designed to be field-cut from the bottom of the track. See installation instructions for detail.
- A wall-mounted Compose panel may require a field-installed shim when used with wall track to support a corner or transitional worksurface. Refer to Specification Guide.
- In a component end mount condition, wall track will not add additional width.

To Order, Specify:

- 1) Product number.
- 2) Trim color.

Height	Width	Depth	Locations	Wall Attachment	Number	Trim	
						A	B
30"(762mm)	1"(25mm)	0.75"(19mm)		4 holes	VZAT-3000	\$102.55	\$127.95
66"(1676mm)				10 holes	VZAT-6600	158.03	183.43
74"(1880mm)				11 holes	VZAT-7400	170.33	195.73

Back for Wall Mounted Overhead Storage Unit

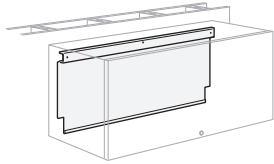

UUFB-P
Class CA

Features

- Includes one painted back and mounting hardware.
- Used to cover wall mount attachment brackets.

Specification Tips

- For use on Wall Mount Overhead Storage Units only.
- Back must match width of Wall Mounted Overhead Storage Units.

To Order, Specify:

- 1) Product number.
- 2) Trim color.

Outside

Height	Width	Number	Trim	
			A	B
16"(406mm)	24"(610mm)	UUFB-0024-P	\$ 416.97	\$459.42
	30"(762mm)	UUFB-0030-P	426.70	469.15
	36"(914mm)	UUFB-0036-P	436.43	478.88
	42"(1067mm)	UUFB-0042-P	446.16	488.61
	48"(1219mm)	UUFB-0048-P	455.89	498.34
	54"(1372mm)	UUFB-0054-P	465.62	508.07
	60"(1524mm)	UUFB-0060-P	475.35	517.80
	66"(1676mm)	UUFB-0066-P	485.08	527.53
	72"(1829mm)	UUFB-0072-P	494.81	537.26

Worksurface and Gallery Panel Wall Mount Bracket

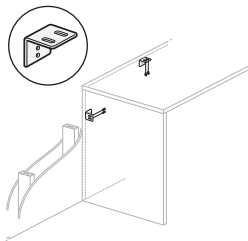

ZUBW
Class CA

Feature

- Includes one steel non-handed bracket and hardware.

Specification Tips

- **Screws/anchors for attachment to wall are field supplied.**
- **Must be properly anchored to a structural wall.**
- May be used to mount:
 - Gallery Panel to wall
 - Two brackets required
 - Worksurface to wall
 - 24"(610mm)-42"(1067mm)W requires two brackets
 - 48"(1219mm)-78"(1981mm)W requires three brackets
 - 84"(2134mm)-120"(3048mm)W requires four brackets
 - Worksurface Support Panel to wall
 - One bracket required
- Worksurface front corner support requirements:
 - One corner must be floor supported.
 - Second corner must be floor supported or attached to an adjacent worksurface with flush mount kit.
 - Distance between floor supports may not exceed 10 feet.

To Order, Specify:

- 1) Product number.
- 2) Trim color (if applicable).

Description	Depth	Width	Number	Price	Trim	
					A	B
Attachment Bracket (Black)	2"(51mm)	2"(51mm)	ZUBW-0000-PN	\$38.18	N/A	N/A
Attachment Bracket (trim color required)	2"(51mm)	2"(51mm)	ZUBW-0000-CN	N/A	\$44.27	\$52.00

Wall Mount Components

Tackboard, Wall Mount

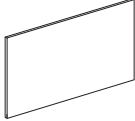

KUAF
Class CA

Feature

- Includes one tackboard and attachment hardware for structural wall.

Specification Tips

- Designed to be used under wall mounted overhead storage units.
- **Not for use with wall track.**

To Order, Specify:

- 1) Product number.
- 2) Fabric surface and color.

Nominal Height	Width	Number	Fabric					
			A	B	C	E	F	G
16"(406mm)	24"(610mm)	KUAF-1624	\$284.84	\$294.23	\$303.62	\$350.58	\$ 376.31	\$392.39
	30"(762mm)	KUAF-1630	336.85	348.58	360.31	419.01	451.18	471.28
	36"(914mm)	KUAF-1636	396.45	410.57	424.65	495.09	533.69	557.85
	42"(1067mm)	KUAF-1642	449.72	466.19	482.62	564.80	609.83	638.02
	48"(1219mm)	KUAF-1648	502.99	521.82	540.59	634.51	685.98	718.19
	54"(1372mm)	KUAF-1654	556.26	577.44	598.56	704.22	762.12	798.36
	60"(1524mm)	KUAF-1660	609.53	633.06	656.53	773.93	838.26	878.53

Markerboard, Wall Mount

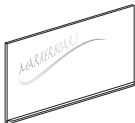

KUAM
Class CA

Features

- Includes non-magnetic white laminate erasable writing surface with tray and attachment hardware for structural wall.
- Tray available in charcoal only.
- Markers and erasers not included.

Specification Tips

- Designed to be used under wall mounted overhead storage units.
- Does not allow task light cord to pass behind.

• Not for use with wall track.

• The following products are recommended to maintain the markerboard appearance:

- Dry erase marker kit (includes holder, six markers and eraser), order part# 7062-8001.
- Markerboard cleaner and conditioner, order part# 7031-7001.
- Markerboard spray cleaner, order part# 7031-7002.

To Order, Specify:

- 1) Product number.
(No finish specification required.)

Nominal Height	Width	Number	Price
16"(406mm)	24"(610mm)	KUAM-1624	\$ 470.36
	30"(762mm)	KUAM-1630	496.94
	36"(914mm)	KUAM-1636	523.52
	42"(1067mm)	KUAM-1642	550.10
	48"(1219mm)	KUAM-1648	576.68
	54"(1372mm)	KUAM-1654	603.26
	60"(1524mm)	KUAM-1660	629.84
24"(610mm)	24"(610mm)	KUAM-2424	\$ 619.37
	30"(762mm)	KUAM-2430	645.95
	36"(914mm)	KUAM-2436	672.53
	42"(1067mm)	KUAM-2442	699.11
	48"(1219mm)	KUAM-2448	725.69
	54"(1372mm)	KUAM-2454	752.27
	60"(1524mm)	KUAM-2460	778.85
32"(813mm)	24"(610mm)	KUAM-3224	\$ 837.80
	30"(762mm)	KUAM-3230	864.38
	36"(914mm)	KUAM-3236	890.96
	42"(1067mm)	KUAM-3242	917.54
	48"(1219mm)	KUAM-3248	944.12
	54"(1372mm)	KUAM-3254	970.70
	60"(1524mm)	KUAM-3260	997.28

Lighting

Task

Reed Premiere™ Stand-Alone LED Task Light

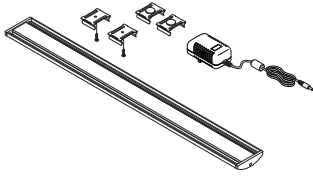

LUTS-0017-19ULD5
Class YA

Features

- Includes 17"(432mm) LED fixture, 15 watt power supply with nine foot removable power cord.
- Standard in anodized (silver) color with white end caps.
- Height: 0.5"(13mm); Width: 2.0"(51mm); Length: 16.4"(417mm).

Specification Tips

- For use with 120 volt, 60 hertz electrical system.
- Color Temp: 3500K.
- Color Rendition Index: 84 CRI.
- Rated Lifespan: 50,000 hour.
- Not intended for daisy chaining.
- Single touch on/off with continuous dimming from 15-100%.
- Automatic shutoff after 10 hours.
- Includes screw and magnetic attachment hardware for steel, laminate and wood.
- Intended for use in horizontal applications.

To Order, Specify:

- 1) Product number.
(No finish specification required.)

Fixture Length	Watts	Number	Price
16.4"(417mm)	7.8	LUTS-0017-19ULD5	\$366.83

Reed Premier™ Starter LED Task Light

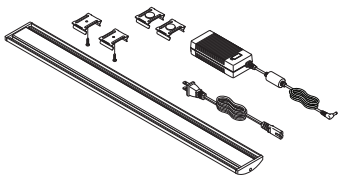

LUTS-0017-12ULD6
Class YA

Features

- Includes LED fixture, 60 watt power supply with twelve foot removable power cord.
- Standard in anodized (silver) color with white end caps.
- Height: 0.5"(13mm); Width: 2.0"(51mm); Lengths: 16.4"(417mm), 30.1"(765mm), 43.7"(1110mm) or 57.4"(1458mm).

Specification Tips

- For use with 120 volt, 60 hertz electrical system.
- Color Temp: 3500K.
- Color Rendition Index: 84 CRI.
- Rated Lifespan: 50,000 hour.
- Refer to the Specification Guide for a chart showing the total number of light fixtures that can be daisy chained together.
- Single touch on/off with continuous dimming from 15-100%.
- Automatic shutoff after 10 hours.
- Includes screw and magnetic attachment hardware for steel, laminate and wood.
- Intended for use in horizontal applications.

To Order, Specify:

- 1) Product number.
(No finish specification required.)

Fixture Length	Watts	Number	Price
16.4"(417mm)	7.8	LUTS-0017-12ULD6	\$504.40
30.1"(765mm)	17.6	LUTS-0031-12ULD6	734.00
43.7"(1110mm)	25.9	LUTS-0044-12ULD6	947.20
57.4"(1458mm)	33.6	LUTS-0058-12ULD6	1176.80

Lighting Task

Reed Premiere™ Add-On LED Task Light — For Use with Reed Premier Starter LED Task Lights

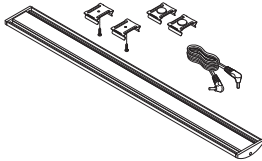

LUTD-0017-1NULDN
Class YA



Features

- Includes LED fixture, 8”(203mm) and 30”(762mm) daisy chain cord.
- Standard in anodized (silver) color with white end caps.
- Height: 0.5”(13mm); Width: 2.0”(51mm); Lengths: 16.4”(417mm), 30.1”(765mm), 43.7”(1110mm) or 57.4”(1458mm).

Specification Tips

- For use with 120 volt, 60 hertz electrical system.
- Color Temp: 3500K.
- Color Rendition Index: 84 CRI.
- Rated Lifespan: 50,000 hour.
- Refer to the Specification Guide for a chart showing the total number of light fixtures that can be daisy chained together.
- Single touch on/off with continuous dimming from 15-100%.
- Automatic shutoff after 10 hours.
- Includes screw and magnetic attachment hardware for steel, laminate and wood.
- Intended for use in horizontal applications.

To Order, Specify:

- 1) Product number.
(No finish specification required.)

Fixture Length	Watts	Number	Price
16.4”(417mm)	7.8	LUTD-0017-1NULDN	\$ 366.83
30.1”(765mm)	17.6	LUTD-0031-1NULDN	596.43
43.7”(1110mm)	25.9	LUTD-0044-1NULDN	809.63
57.4”(1458mm)	33.6	LUTD-0058-1NULDN	1039.23

Reed Premier™ Add-On Occupancy Sensor

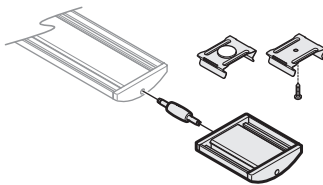

LUTS-0000
Class YA



Features

- Includes occupancy sensor and attachment connector.
- Standard in anodized (silver) color with white end caps.
- Height: 0.7”(18mm); Width: 2.0”(51mm); Length: 2.3”(58mm).

Specification Tips

- For use with 120 volt, 60 hertz electrical system.
- Includes screw and magnetic attachment hardware for steel, laminate and wood.
- Intended for use in horizontal applications.

To Order, Specify:

- 1) Product number.
(No finish specification required.)

Number	Price
LUTS-0000	\$ 412.73

Lighting

Task

Adaptable LED Task Light – Stand Alone

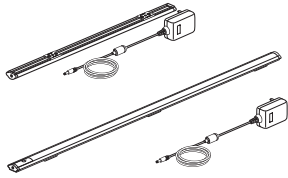

LUTN
Class YA – GSA Open Market



Features

- Includes 17”(432mm), 31”(787mm) or 44”(1118mm) LED fixture, 18 watt power supply with black nine foot power cord, two adhesive cord managers and screw/magnetic attachment hardware.
- Standard in anodized (silver) color with black caps.
- Height: 0.5”(13mm); Width: 1.18”(30mm).
- Automatic turn off after 12 hours (+/- 15 mins).

Specification Tips

- For use with 120 volt, 60 hertz electrical system.
- Color Temp: 3500K.
- Color Rendition Index: 82+ CRI.
- Rated Lifespan: >43,800 hour.
- **Not intended for daisy chaining.**
- Single touch on/off with continuous dimming from 15-100% with last state memory.
- Intended for use under shelf or cabinet.

To Order, Specify:

- 1) Product number.
(No finish specification required.)

Fixture Length	Total Length with Switch	Watts	Number	Price
17”(432mm)	18.8”(478mm)	5.6	LUTN-0017-19ULDN	\$244.53
31”(787mm)	32.8”(833mm)	10.3	LUTN-0031-19ULDN	277.57
44”(1118mm)	45.8”(1163mm)	14.3	LUTN-0044-19ULDN	308.25

Adaptable LED Task Light – Starter Kit

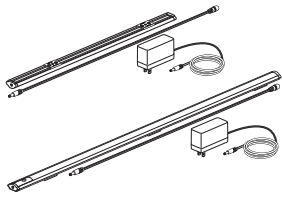

LUTT
Class YA – GSA Open Market



Features

- Includes LED fixture, 65 watt power supply with ten foot power cord, two adhesive cord managers, and screw/magnetic attachment hardware.
- Standard in anodized (silver) color with black caps.
- Height: 0.5”(13mm); Width: 1.18”(30mm).
- Automatic turn off after 12 hours (+/- 15 mins).

Specification Tips

- For use with 120 volt, 60 hertz electrical system.
- Color Temp: 3500K.
- Color Rendition Index: 82+ CRI.
- Rated Lifespan: >43,800 hour.
- Refer to the Specification Guide or under the Adaptable LED Task Light - Add-On Kit for a chart showing the total number of light fixtures that can be daisy chained together.
- Single touch on/off with continuous dimming from 15-100% with last state memory.
- The on/off dimmer switch on the Starter Kit fixture will control all connected Add-On lights.
- Intended for use under shelf or cabinet.

To Order, Specify:

- 1) Product number.
(No finish specification required.)

Fixture Length	Total Length with Switch	Watts	Number	Price
17”(432mm)	18.8”(478mm)	5.6	LUTT-0017-11ULDN	\$ 277.41
31”(787mm)	32.8”(833mm)	10.3	LUTT-0031-11ULDN	310.45
44”(1118mm)	45.8”(1163mm)	14.3	LUTT-0044-11ULDN	341.13

Lighting

Task

Adaptable LED Task Light – Add-On Kit

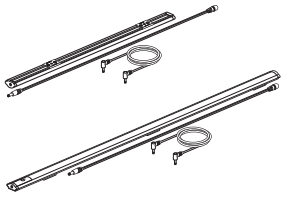

LUTA
Class YA – GSA Open Market



Features

- Includes LED fixture, 30”(762mm) daisy chain cord, two adhesive cord managers, and screw/magnetic attachment hardware.
- Standard in anodized (silver) color with black caps.
- Height: 0.5”(13mm); Width: 1.18”(30mm).

Specification Tips

- For use with 120 volt, 60 hertz electrical system.
- Color Temp: 3500K.
- Color Rendition Index: 82+ CRI.
- Rated Lifespan: >43,800 hour.
- Refer to the chart at right for the total number of light fixtures that can be daisy chained together.
- The on/off dimmer switch on the Starter Kit fixture will control all connected Add-On lights.
- Intended for use under shelf or cabinet.

To Order, Specify:

- 1) Product number.
(No finish specification required.)

Acceptable Daisy Chain Light Combinations

Daisy Chain Combinations	# of 17” Lights	# of 31” Lights	# of 44” Lights
Combination 1	1	1	1
Combination 2	1	1	0
Combination 3	1	2	0
Combination 4	1	0	1
Combination 5	2	1	0
Combination 6	2	0	1
Combination 7	2	0	0
Combination 8	3	1	0
Combination 9	3	0	0
Combination 10	4	0	0
Combination 11	0	1	1
Combination 12	0	2	0
Combination 13	0	3	0
Combination 14	0	0	2

Fixture Length	Watts	Number	Price
17”(432mm)	5.6	LUTA-0017-1NULDN	\$205.92
31”(787mm)	10.3	LUTA-0031-1NULDN	238.96
44”(1118mm)	14.3	LUTA-0044-1NULDN	269.64

Compose Resources

Surfaces Materials

COM Yardage Requirements

Index

Warranty/Terms of Sale

Surface Materials

Finish Color Legend

Wood

Grade A

Double Cut

2P-RL	Applegate
CQ-HKL	Auburn
CQ-HBF	Clove
WE-RD	Dune
WJ-RE	Ebony
2N-RL	Echo
WE-RT	Melba
W4-PB	Pebble
CQ-WG	Walnut Grove

Grade B

Cherry

VC-CA1	Amber
VC-W23	American
VC-CPK	Bourbon
VC-HKF	Burgundy
VC-W33	Caramel
VC-W30	Heritage
VC-W32	Pacific
VC-HKA	Toffee

Maple

VP-LM	Light
VP-N	Natural

Maple Quarter Cut

NM-N	Natural
------	---------

Oak

VJ-HKC	Urban
--------	-------

Rift Cut White Oak

NR-W15	Espresso
NR-W40	Mocha

Walnut

VR-HKG	Colombian
VR-W15	Espresso
VR-W31	Retro

Walnut Quarter Cut

NW-W35	Clear
NW-W31	Retro

HPL

Grade A

Solid Color

H-34	Beige
H-AK	Chalk
H-8J	Charcoal
H-3J	Graphite
H-62	Gray Tone
H-WL	Linen
H-3P	Platinum
H-AA	Putty
H-3E	Smoke

Patterned

H-P1	Linen Casual
H-P2	Linen Classic
H-P3	Linen Crisp
H-P4	Linen Flax

Wood

H-B06	Brazilwood
H-E79	Colombian Walnut
H-AE	Maple
H-DYP	New Age Oak
H-E15	River Cherry
H-C09	Williamsburg Cherry

Grade B

Premium Wood Grain

H-C8	Blonde Modern Cherry
H-D1	Daintree
H-KP	Field Elm
H-KN	Grey Elm
H-KM	Landmark Wood
H-D2	Mocha Modern Cherry
H-KL	Neo Walnut
H-KR	Phantom Ecu
H-KS	Phantom Pearl
H-C9	Spiced Modern Cherry

Grade E

Premium

H-C2	Drift
H-C6	Hatch
H-C1	Hay
H-C5	Mineral
H-C4	Molasses
H-C3	Pecan
H-C7	Tanned

Edgeband

Solid Color

HP-34	Beige
HP-AK	Chalk
HP-8J	Charcoal
HP-3J	Graphite
HP-62	Gray Tone
HP-WL	Linen
HP-3P	Platinum
HP-AA	Putty
HP-3E	Smoke

Patterned Edgeband

HP-P1	Linen Casual
HP-P2	Linen Classic
HP-P3	Linen Crisp
HP-P4	Linen Flax

Wood Grain

HP-C8	Blonde Modern Cherry
HP-B06	Brazilwood
HP-E79	Colombian Walnut
HP-D1	Daintree
HP-KP	Field Elm
HP-KN	Grey Elm
HP-KM	Landmark Wood
HP-AE	Maple
HP-D2	Mocha Modern Cherry
HP-KL	Neo Walnut
HP-DYP	New Age Oak
HP-KR	Phantom Ecu
HP-KS	Phantom Pearl
HP-E15	River Cherry
HP-C9	Spiced Modern Cherry
HP-C09	Williamsburg Cherry

Ply-Edge

HP-PW	Ply-Edge
-------	----------

Premium

HP-C2	Drift
HP-C6	Hatch
HP-C1	Hay
HP-C5	Mineral
HP-C4	Molasses
HP-C3	Pecan
HP-C7	Tanned

Trim

Grade A

Smooth

TR-R	Beige
TR-AK	Chalk
TR-K	Charcoal
TR-C1	Cocoa
TR-J	Graphite
TR-G	Gray Tone
TR-AA	Putty
TR-E	Smoke
TR-PLS	Smooth Plaster
TR-FM	Snow

Textured

TR-TG	Grout
TR-TF	Pitch
TR-TW	Plaster

Grade B

Smooth

TR-IC	Accent Blue
TR-IG	Blue Jay
TR-1R	Brownstone
TR-1N	Night
TR-1Q	Park
TR-RR	Rusty Red
TR-IM	Sable
TR-1J	Sky Blue

Smooth Metallic

TR-DM	Dark Bronze Metallic
TR-MC	Metallic Champagne
TR-MG	Metallic Gunmetal
TR-LE	Metallic Silver

Textured Metallic

TR-AR	Argent
TR-HE	Hellenic

Tempered

Glass

Grade A

1G-1C	Clear
-------	-------

Grade C

1G-E23	Satin Etched
SQ-ER	English Reeded

Grade D

SQ-CM	Checks Mix
SQ-VM	Vertical Moire

Acrylic

Grade D

SK-1E	Frosted
-------	---------

Lock Plugs

LR-BL	Black
LR-BP	Chrome

ALERT: These materials are current, however they are being considered for future obsolescence due to low volume.

<h4>Wood</h4> <table border="0"> <tr><td>VJ-W42</td><td>Brindle</td></tr> <tr><td>2R-RL</td><td>Butternut</td></tr> <tr><td>NW-W15</td><td>Espresso</td></tr> <tr><td>NP-W08</td><td>Golden</td></tr> <tr><td>NP-W07</td><td>Light</td></tr> <tr><td>NX-U</td><td>Medium</td></tr> <tr><td>VR-W12</td><td>Naturally Walnut</td></tr> <tr><td>VP-AD</td><td>Sand</td></tr> <tr><td>WC-RW</td><td>Wenge</td></tr> </table>	VJ-W42	Brindle	2R-RL	Butternut	NW-W15	Espresso	NP-W08	Golden	NP-W07	Light	NX-U	Medium	VR-W12	Naturally Walnut	VP-AD	Sand	WC-RW	Wenge	<h4>HPL</h4> <table border="0"> <tr><td>H-AM</td><td>Amber Cherry</td></tr> <tr><td>H-AD</td><td>Medium Cherry</td></tr> </table>	H-AM	Amber Cherry	H-AD	Medium Cherry	<h4>Edgeband</h4> <table border="0"> <tr><td>HP-AM</td><td>Cherry</td></tr> <tr><td>HP-AD</td><td>Medium Cherry</td></tr> </table>	HP-AM	Cherry	HP-AD	Medium Cherry	<h4>Trims</h4> <table border="0"> <tr><td>TR-1E</td><td>Accent Orange</td></tr> <tr><td>TR-1F</td><td>Accent Red</td></tr> <tr><td>TR-CTS</td><td>Chartreuse</td></tr> <tr><td>TR-1H</td><td>Terra</td></tr> <tr><td>TR-1K</td><td>Wren</td></tr> </table>	TR-1E	Accent Orange	TR-1F	Accent Red	TR-CTS	Chartreuse	TR-1H	Terra	TR-1K	Wren
VJ-W42	Brindle																																						
2R-RL	Butternut																																						
NW-W15	Espresso																																						
NP-W08	Golden																																						
NP-W07	Light																																						
NX-U	Medium																																						
VR-W12	Naturally Walnut																																						
VP-AD	Sand																																						
WC-RW	Wenge																																						
H-AM	Amber Cherry																																						
H-AD	Medium Cherry																																						
HP-AM	Cherry																																						
HP-AD	Medium Cherry																																						
TR-1E	Accent Orange																																						
TR-1F	Accent Red																																						
TR-CTS	Chartreuse																																						
TR-1H	Terra																																						
TR-1K	Wren																																						

Surface Materials

Fabrics/Color Legend

Vertical Fabrics

Grade A

- (36) Aerial
- (6X) Chevron
- (35) Etch
- (L6) Highlands
- (C1) Striae
- (PY) Tailored
- (3A) Tellure

Grade B

- (4HV) Blanket
- (33) Camp
- (L5) Classic
- (34) Fields
- (3JV) Hobson
- (6) Hue
- (ZR) Kio
- (3LV) Novelty
- (32) Peca
- (PV) Ritz
- (WS) Shimmer

Grade C

- (SW) Sisal
- (4S) Thorman

Grade D

- (6KV) Dots
- (3SV) Scapes

* For most current finish and fabric availability please reference surfaces.haworth.com.

ALERT: These materials are current, however they are being considered for future obsolescence due to low volume.

Vertical Fabrics

(PH) Birds Nest

Haworth+

For information on the Haworth+ alliance program, including images and product availability, please refer to: Haworth.com > Surface Collection > Haworth+ Library

Customer's Own Material (COM)

For general Customer's Own Material (COM) information including processes and forms, please refer to: Haworth.com > Surface Collection > Resources > COM

For information on approved COM's, please refer to: Haworth.com > Surface Collection > COM Library

COM Yardage Requirements

Compose Tile Fabric Usage

Nominal (Inches)		66"(1676mm) Roll (Linear Yards)			54"(1372mm) Roll (Linear Yards)		
Height	Width	Directional	Railroad	Non-directional	Directional	Railroad	Non-directional
8"(203mm)	18"(457mm)	0.111	0.122	0.111	0.167	0.153	0.153
	24"(610mm)	0.167	0.156	0.156	0.167	0.195	0.167
	30"(762mm)	0.167	0.189	0.167	0.334	0.236	0.236
	36"(914mm)	0.334	0.222	0.222	0.334	0.278	0.278
	42"(1067mm)	0.334	0.256	0.256	0.334	0.320	0.320
	48"(1219mm)	0.334	0.289	0.289	0.334	0.361	0.334
	60"(1524mm)	0.334	0.356	0.334	N/A	0.445	0.445
16"(406mm)	72"(1829mm)	N/A	0.422	0.422	N/A	0.528	0.528
	18"(457mm)	0.185	0.204	0.185	0.278	0.306	0.278
	24"(610mm)	0.278	0.259	0.259	0.278	0.389	0.278
	30"(762mm)	0.278	0.315	0.278	0.556	0.473	0.473
	36"(914mm)	0.556	0.371	0.371	0.556	0.556	0.556
	42"(1067mm)	0.556	0.426	0.426	0.556	0.639	0.556
	48"(1219mm)	0.556	0.482	0.482	0.556	0.723	0.556
24"(610mm)	60"(1524mm)	0.556	0.593	0.556	N/A	0.889	0.889
	72"(1829mm)	N/A	0.704	0.704	N/A	1.056	1.056
	18"(457mm)	0.259	0.306	0.259	0.389	0.306	0.306
	24"(610mm)	0.389	0.389	0.389	0.389	0.389	0.389
	30"(762mm)	0.389	0.473	0.389	0.778	0.473	0.473
	36"(914mm)	0.778	0.556	0.556	0.778	0.556	0.556
	42"(1067mm)	0.778	0.639	0.639	0.778	0.639	0.639
32"(813mm)	48"(1219mm)	0.778	0.723	0.723	0.778	0.723	0.723
	60"(1524mm)	0.778	0.889	0.778	N/A	0.889	0.889
	72"(1829mm)	N/A	1.056	1.056	N/A	1.056	1.056
	18"(457mm)	0.333	0.612	0.333	0.500	0.612	0.500
	24"(610mm)	0.500	0.778	0.500	0.500	0.778	0.500
	30"(762mm)	0.500	0.945	0.500	1.000	0.945	0.945
	36"(914mm)	1.000	1.112	1.000	1.000	1.112	1.000
40"(1016mm)	42"(1067mm)	1.000	1.278	1.000	1.000	1.278	1.000
	48"(1219mm)	1.000	1.445	1.000	1.000	1.445	1.000
	60"(1524mm)	1.000	1.778	1.000	N/A	1.778	1.778
	72"(1829mm)	N/A	2.112	2.112	N/A	2.112	2.112
	18"(457mm)	0.408	0.612	0.408	0.612	0.612	0.612
	24"(610mm)	0.612	0.778	0.612	0.612	0.778	0.612
	30"(762mm)	0.612	0.945	0.612	1.223	0.945	0.945
48"(1219mm)	36"(914mm)	1.223	1.112	1.112	1.223	1.112	1.112
	42"(1067mm)	1.223	1.278	1.223	1.223	1.278	1.223
	48"(1219mm)	1.223	1.445	1.223	1.223	1.445	1.223
	60"(1524mm)	1.223	1.778	1.223	N/A	1.778	1.778
	72"(1829mm)	N/A	2.112	2.112	N/A	2.112	2.112
	18"(457mm)	0.482	0.612	0.482	0.723	0.612	0.612
	24"(610mm)	0.723	0.778	0.723	0.723	0.778	0.723
56"(1422mm)	30"(762mm)	0.723	0.945	0.723	1.445	0.945	0.945
	36"(914mm)	1.445	1.112	1.112	1.445	1.112	1.112
	42"(1067mm)	1.445	1.278	1.278	1.445	1.278	1.278
	48"(1219mm)	1.445	1.445	1.445	1.445	1.445	1.445
	60"(1524mm)	1.445	1.778	1.445	N/A	1.778	1.778
	72"(1829mm)	N/A	2.112	2.112	N/A	2.112	2.112
	18"(457mm)	0.556	0.612	0.556	0.834	N/A	0.834
60"(1524mm)	24"(610mm)	0.834	0.778	0.778	0.834	N/A	0.834
	30"(762mm)	0.834	0.945	0.834	1.667	N/A	1.667
	36"(914mm)	1.667	1.112	1.112	1.667	N/A	1.667
	42"(1067mm)	1.667	1.278	1.278	1.667	N/A	1.667
	48"(1219mm)	1.667	1.445	1.445	1.667	N/A	1.667
	60"(1524mm)	1.667	1.778	1.667	N/A	N/A	N/A
	72"(1829mm)	N/A	2.112	2.112	N/A	N/A	N/A

COM Yardage Requirements

Compose Tile Fabric Usage

Nominal (Inches)		66"(1676mm) Roll (Linear Yards)			54"(1372mm) Roll (Linear Yards)		
Height	Width	Directional	Railroad	Non-directional	Directional	Railroad	Non-directional
64"(1626mm)	18"(457mm)	0.630	0.612	0.612	0.945	N/A	0.945
	24"(610mm)	0.945	0.778	0.778	0.945	N/A	0.945
	30"(762mm)	0.945	0.945	0.945	1.889	N/A	1.889
	36"(914mm)	1.889	1.112	1.112	1.889	N/A	1.889
	42"(1067mm)	1.889	1.278	1.278	1.889	N/A	1.889
	48"(1219mm)	1.889	1.445	1.445	1.889	N/A	1.889
	60"(1524mm)	1.889	1.778	1.778	N/A	N/A	N/A
72"(1829mm)	72"(1829mm)	N/A	2.112	2.112	N/A	N/A	N/A
	18"(457mm)	0.704	N/A	0.704	1.056	N/A	1.056
	24"(610mm)	1.056	N/A	1.056	1.056	N/A	1.056
	30"(762mm)	1.056	N/A	1.056	2.112	N/A	2.112
	36"(914mm)	2.112	N/A	2.112	2.112	N/A	2.112
	42"(1067mm)	2.112	N/A	2.112	2.112	N/A	2.112
	48"(1219mm)	2.112	N/A	2.112	2.112	N/A	2.112
	60"(1524mm)	2.112	N/A	2.112	N/A	N/A	N/A
72"(1829mm)	N/A	N/A	N/A	N/A	N/A	N/A	

Index

Products are listed alphabetically in this index by alpha-numeric prefix/suffix codes.

Product Code	Product Description	Page
7031-0501	Panel Accessories – Friction Pad	.106
ATSP	Compose Echo Accessory – Ledge	.66
AUC1	Worksurface Support – Column Leg	.259
EUAW-4000-V	Electrical Components – Compose Connections Cable Chain	.135
EUEB-0000-2HY	Electrical Components – Base Feed Module — Hardwire Connection — Connections and Beam	.112
EUEB-0000-3HY	Electrical Components – Base Feed Module — Hardwire Connection — Connections and Beam	.112
EUEB-0000-4HY	Electrical Components – Base Feed Module — Hardwire Connection — Connections and Beam	.112
EUEH-0087	Electrical Components – Infeed Harness	.119
EUEH-00FO	Electrical Components – Infeed Harness	.119
EUEH-00WO	Electrical Components – Infeed Harness	.119
EUEJ-0064-2WF	Electrical Components – Internal Power Base AI Base Feed	.113
EUEJ-0064-3WF	Electrical Components – Internal Power Base AI Base Feed	.113
EUEJ-0064-4WF	Electrical Components – Internal Power Base AI Base Feed	.113
EUER-15	Electrical Components – Triplex Receptacle — 15 Amp	.129
EUER-20	Electrical Components – Triplex Receptacle — 20 Amp	.130
EZEJ-0048-2WF	Electrical Components – Raised Floor Infeed Base Feed Module	.114
EZEJ-0048-3WF	Electrical Components – Raised Floor Infeed Base Feed Module	.114
EZEJ-0048-4WF	Electrical Components – Raised Floor Infeed Base Feed Module	.114
FBEW-0004-31	Electrical Components – Wall Feed Field Wired 1 Port	.114
FBEW-0004-41	Electrical Components – Wall Feed Field Wired 1 Port	.114
HAB	Panel Accessories – Anchoring Bracket	.106
KUAF	Wall Mount Components – Tackboard, Wall Mount	.292
KUAM	Wall Mount Components – Markerboard, Wall Mount	.292
KZAF	External Mount Tiles — Full Panel and Connections – Tackboard, External Mount	.67
KZAM	External Mount Tiles — Full Panel and Connections – Markerboard, External Mount	.68
KZPY-16	External Mount Tiles — Full Panel and Connections – Slat, 16" External Mount	.67
LUTA	Lighting – Task — Adaptable LED Task Light – Add-On Kit	.296
LUTD-0017-1NULDN	Lighting – Task — Reed Premiere™ Add-On LED Task Light — For Use with Reed Premier Starter LED Task Lights	.294
LUTN	Lighting – Task — Adjustable LED Task Light – Stand-Alone	.295
LUTS-0000	Lighting – Task — Reed Premier™ Add-On Occupancy Sensor	.294
LUTS-0017-12ULD6	Lighting – Task — Reed Premier™ Starter LED Task Light	.293
LUTS-0017-19ULD5	Lighting – Task — Reed Premiere™ Stand-Alone LED Task Light	.293
NADR-8	Upper Storage — Adaptable – Shelf Divider	.285
NECK-1	Electrical Components – Information Plate Communication Port Kits	.131
NECK-2	Electrical Components – Information Plate Communication Port Kits	.131
NEP-1	Electrical Components – Power Break Marker	.135
NUB-1	Upper Storage — Adaptable – Overhead Storage Unit / Shelf Gang Clip	.285
STUT	Gallery Panel Accessories – Compose Echo Tackboard	.206
SYCD	Gallery Panel to Gallery Panel Face Attachment – C (Center Mount)	.191
SYCJ	Gallery Panel to Compose Beam End-of-Run – C (Center Mount)	.176
SYCW	Gallery Panel to Compose Panel End-of-Run – C (Center Mount)	.156
SYCZ	Gallery Panel to Compose Panel End-of-Run – C (Center Mount)	.156
SYEJ (Right Face)	Gallery Panel to Compose Beam End-of-Run – W/E (Half Left or Half Right Mount)	.171
SYEW (Right Face)	Gallery Panel to Compose Panel End-of-Run – W/E (Half Left or Half Right Mount)	.151
SYEZ	Gallery Panel to Compose Panel End-of-Run – W/E (Half Left or Half Right Mount)	.151
SYGG	Gallery Panel Accessories – Insert Glass — Gallery Panel Glass Ready Option	.204
SYHJ	Gallery Panel to Compose Beam Intermediate – H (Two Sided Half Left/Right)	.182
SYHW	Gallery Panel to Compose Panel Intermediate – H (Two-Sided Half Left/Right)	.162
SYHZ	Gallery Panel to Compose Panel Intermediate – H (Two-Sided Half Left/Right)	.162
SYLD (Left Face)	Gallery Panel to Gallery Panel Face Attachment – L/R (Left or Right Mount)	.188
SYLJ (Left Face)	Gallery Panel to Compose Beam End-of-Run – L/R (Left or Right Mount)	.168

Index

<u>Product Code</u>	<u>Product Description</u>	<u>Page</u>
SYLW (Left Face)	Gallery Panel to Compose Panel End-of-Run – L/R (Left or Right Mount)148
SYLZ	Gallery Panel to Compose Panel End-of-Run – L/R (Left or Right Mount)148
SYPT	Gallery Panel Accessories – Trim Post — 3-Way or 4-Way — Intermediate Full Height210
SYPX	Gallery Panel Accessories – Trim Post — Variable Height — Intermediate Intersection209
SYRD (Right Face)	Gallery Panel to Gallery Panel Face Attachment – L/R (Left or Right Mount)188
SYRJ (Right Face)	Gallery Panel to Compose Beam End-of-Run – L/R (Left or Right Mount)168
SYRW (Right Face)	Gallery Panel to Compose Panel End-of-Run – L/R (Left or Right Mount)148
SYRZ	Gallery Panel to Compose Panel End-of-Run – L/R (Left or Right Mount)148
SYSN	Gallery Panel to Gallery Panel End Attachment – I (90° Face or Post Connection)194
SYSN	Gallery Panel to Gallery Panel End Attachment – S (Straight In-Line Add-On)197
SYTI	Gallery Panel Accessories – Compose Tile Hardware Kit207
SYTJ	Gallery Panel to Compose Beam Intermediate – T (Two Sided Left/Right)179
SYTW	Gallery Panel to Compose Panel Intermediate – T (Two-Sided Left/Right)159
SYTZ	Gallery Panel to Compose Panel Intermediate – T (Two-Sided Left/Right)159
SYWB	Gallery Panel Accessories – Gallery Panel Hanging Brackets208
SYWJ (Left Face)	Gallery Panel to Compose Beam End-of-Run – W/E (Half Left or Half Right Mount)171
SYWW (Left Face)	Gallery Panel to Compose Panel End-of-Run – W/E (Half Left or Half Right Mount)151
SYWZ	Gallery Panel to Compose Panel End-of-Run – W/E (Half Left or Half Right Mount)151
SYXJ	Gallery Panel to Compose Beam Intermediate – X (Center - Two-Sided Mount)185
SYXW	Gallery Panel to Compose Panel Intermediate – X (Center - Two Sided Mount)165
SYXZ	Gallery Panel to Compose Panel Intermediate – X (Center - Two Sided Mount)165
UQFS-LG	Upper Storage – Storage Box267
UQFS-LL	Upper Storage – Storage Box267
UQFS-LN	Upper Storage – Storage Box267
UQFS-LW	Upper Storage – Storage Box267
UUFb-P	Wall Mount Componentse – Back for Wall Mounted Overhead Storage Unit291
UUFs-PW	Wall Mount Components – Overhead Storage Unit — Wall Mount286
UUFH-QW	Wall Mount Components – Overhead Storage Unit — Wall Mount286
UUKS-PW	Wall Mount Components – Overhead Storage Unit — Wall Mount286
UZCC	Panel Accessories – Top Trim — Off Modular Top Trim89
UZFS-PM	Upper Storage — Adaptable – Overhead Storage Unit — Standard Mount275
UZGS-PM	Upper Storage — Adaptable – Overhead Storage Unit — Up Mount280
UZHF-QM	Upper Storage — Adaptable – Overhead Storage Unit — Standard Mount275
UZJS-PM	Upper Storage — Adaptable – Overhead Storage Unit — Up Mount280
UZKS-PM	Upper Storage — Adaptable – Overhead Storage Unit — Standard Mount275
UZLS-PM	Upper Storage — Adaptable – Overhead Storage Unit — Up Mount280
UZSN	Upper Storage — Adaptable – Open Shelf Standard Mount285
UUFZ	Panel Accessories – Sliding Door86
VZAB	Electrical Components – Frame Mounted Power Tap Bracket — Concealed134
VZAB-0204	Electrical Components – Frame Mounted Data Plate Bracket — Concealed134
VZAD-0000-B	Electrical Components – Data Blank Cover — Beam133
VZAD-0000-R	Electrical Components – Data Blank Cover — Full Panel and Connections132
VZAG	Electrical Components – Tile Grommet Kit133
VZAJ-0000	Electrical Components – Communication Data Bracket — Beam132
VZAL	Panel Accessories – Aligner/Light Block104
VZAL	Panel Accessories – Half Aligner/Light Block104
VZAL-1600	Panel Accessories – Vertical Light Block (Between Panel)105
VZAP-0000-C	Electrical Components – Hardwire — Receptacle Plate, Hardwired144
VZAP-0000-G	Electrical Components – Adaptor Plate, Single Gang134
VZAP-0000-J	Electrical Components – Power and Communication Bezel — Beam132
VZAP-0000-R	Electrical Components – Hardwire — Receptacle Plate, Hardwired144
VZAP-0000-T	Electrical Components – Power and Communication Bezel — Full Panel and Connections131

Index

Product Code	Product Description	Page
VZAR-0000	Electrical Components – Receptacle Blank Cover	.131
VZAT	Wall Mount Componentse – Wall Track	.291
VZAW-0000-V	Electrical Components – Compose Task Light Cord Manager	.135
VZBC-0000	Electrical Components – Cable Management Bracket	.135
VZCC	Panel Accessories – Top Trim — Steel, Aluminum, Wood	.87
VZCC	Panel Accessories – Top Trim — Work Rail	.88
VZCC-0000-H	Panel Accessories – Beam — Steel Trim Top Cap Aligner Clip	.100
VZCE	Panel Accessories – Beam — End-of-Run Trim	.98
VZCE	Panel Accessories – Connections — End-of-Run Trim	.96
VZCE-0000-H	Panel Accessories – Full Panel — End-of-Run Steel Trim Bottom Bracket Clip	.91
VZCE-3400-H	Panel Accessories – Full Panel — End-of-Run Trim — Steel/Aluminum/Wood	.91
VZCE-A	Panel Accessories – Connections — Raceway End-of-Run Cover	.96
VZCE-AANG	Panel Accessories – Full Panel — End-of-Run Trim — Work Rail	.91
VZCG-0000	Panel Accessories – Glass Top Trim Clip Kit	.83
VZCL	Panel Accessories – Beam — Trim and Corner Connectors	.99
VZCL	Panel Accessories – Connections — Trim and Corner Connectors	.97
VZCL	Panel Accessories – Full Panel — Trim and Corner Connectors — Steel, Aluminum, Wood	.92
VZCL-AANG	Panel Accessories – Full Panel — Trim and Corner Connectors — Work Rail	.94
VZCM-G	Panel Accessories – T-Mount	.107
VZCM-P	Panel Accessories – T-Mount	.107
VZCQ-0000	Panel Accessories – Tie Bracket Kit – Glass Stack	.108
VZCR	Panel Accessories – Top Trim — Work Rail Top Trim Cover	.90
VZCS-0000	Panel Accessories – Corner Block Assembly — 90°	.103
VZCT	Panel Accessories – 3-Way Intersection — Spanning Tile Corner Blocks	.103
VZCT	Panel Accessories – Beam — Trim and Corner Connectors — No Top Cap	.100
VZCT	Panel Accessories – Beam — Trim and Corner Connectors	.99
VZCT	Panel Accessories – Connections — Trim and Corner Connectors	.97
VZCT	Panel Accessories – Full Panel — Trim and Corner Connectors — Steel, Aluminum, Wood	.92
VZCT-AANG	Panel Accessories – Full Panel — Trim and Corner Connectors — Work Rail	.94
VZCT-PN	Panel Accessories – Full Panel — Trim and Corner Connectors — 3- & 4-Way Intersection — Top Cap	.95
VZCV	Panel Accessories – Connections — Trim and Corner Connectors	.97
VZCV-A	Panel Accessories – Full Panel — Trim and Corner Connectors — Steel, Aluminum, Wood	.92
VZCV-A	Panel Accessories – Full Panel — Trim and Corner Connectors — Work Rail	.94
VZCW-0000-P	Panel Accessories – Panel Frame Wall Mount	.108
VZCW-G	Panel Accessories – Glass Panel Wall Mount	.108
VZCX	Panel Accessories – Beam — Trim and Corner Connectors — No Top Cap	.100
VZCX	Panel Accessories – Beam — Trim and Corner Connectors	.99
VZCX	Panel Accessories – Connections — Trim and Corner Connectors	.97
VZCX	Panel Accessories – Full Panel — Trim and Corner Connectors — Steel, Aluminum, Wood	.92
VZCX-AANG	Panel Accessories – Full Panel — Trim and Corner Connectors — Work Rail	.94
VZCX-AN	Panel Accessories – Full Panel — Trim and Corner Connectors — 3- & 4-Way Intersection — Top Cap	.95
VZCY	Panel Accessories – Connections — Trim and Corner Connectors	.97
VZCY-0000	Panel Accessories – Corner Block Assembly — 120°	.103
VZCY-A	Panel Accessories – Full Panel — Trim and Corner Connectors — Steel, Aluminum, Wood	.92
VZCY-A	Panel Accessories – Full Panel — Trim and Corner Connectors — Work Rail	.94
VZEB-0000-1	Electrical Components – Single Circuit Base Feed Module — Receptacle Connection with Power Cord	.111
VZEB-0000-12	Electrical Components – Single Circuit Base Feed Module — Receptacle Connection with Power Cord	.111
VZEB-0000-14	Electrical Components – Single Circuit Base Feed Module — Receptacle Connection with Power Cord	.111
VZEB-0000-2	Electrical Components – Single Circuit Base Feed Module — Receptacle Connection with Power Cord	.110
VZEB-0000-22	Electrical Components – Single Circuit Base Feed Module — Receptacle Connection with Power Cord	.110
VZEB-0000-24	Electrical Components – Single Circuit Base Feed Module — Receptacle Connection with Power Cord	.110
VZEB-0000-3	Electrical Components – Base Feed Module — Hardwire Connection	.110

Index

Product Code	Product Description	Page
VZEB-0000-C	Electrical Components – Hardwire — Base Feed Hardwire Plate	.137
VZEB-0000-H2	Electrical Components – Base Feed Module — Hardwire Connection	.110
VZEB-0000-H4	Electrical Components – Base Feed Module — Hardwire Connection	.110
VZEB-0000-Y	Electrical Components – Base Feed Module — Concealed Hardwire Connection	.111
VZEB-0000-Y2U	Electrical Components – Base Feed Module — Hardwire Connection	.112
VZEB-0000-Y3U	Electrical Components – Base Feed Module — Hardwire Connection	.112
VZEB-0000-Y4U	Electrical Components – Base Feed Module — Hardwire Connection	.112
VZEB-0000-YH2	Electrical Components – Base Feed Module — Concealed Hardwire Connection	.111
VZEB-0000-YH4	Electrical Components – Base Feed Module — Concealed Hardwire Connection	.111
VZEF-0B0P	Electrical Components – Flexible Power Connector — Work-height	.126
VZEF-0B0P-2	Electrical Components – Flexible Power Connector — Work-height	.126
VZEF-0B0P-4	Electrical Components – Flexible Power Connector — Work-height	.126
VZEF-0B0Q	Electrical Components – Flexible Power Connector — Corner Span, Work-height	.126
VZEF-0R0P	Electrical Components – Flexible Power Connector — Raceway	.125
VZEF-0R0P-2	Electrical Components – Flexible Power Connector — Raceway	.125
VZEF-0R0P-4	Electrical Components – Flexible Power Connector — Raceway	.125
VZEF-0R0S	Electrical Components – Flexible Power Connector — Straight Span, Raceway/Work-height	.127
VZEF-0R0S-2	Electrical Components – Flexible Power Connector — Straight Span, Raceway/Work-height	.127
VZEF-0R0S-4	Electrical Components – Flexible Power Connector — Straight Span, Raceway/Work-height	.127
VZEF-0B0Q-2	Electrical Components – Flexible Power Connector — Corner Span, Work-height	.126
VZEF-0B0Q-4	Electrical Components – Flexible Power Connector — Corner Span, Work-height	.126
VZEG-0601-V	Electrical Components – Frame Rail Grommet	.133
VZEH-0000	Electrical Components – Full Panel Infeed Harness	.119
VZEH-0030	Electrical Components – Full Panel Infeed Harness	.119
VZEJ-0018	Electrical Components – Extended Power Connector	.127
VZEJ-0024	Electrical Components – Extended Power Connector	.127
VZEJ-0038-2	Electrical Components – Power Connector — Below WS	.128
VZEJ-0038-3	Electrical Components – Power Connector — Below WS	.128
VZEJ-0038-4	Electrical Components – Power Connector — Below WS	.128
VZEJ-3	Electrical Components – Vertical Power Connector	.125
VZEK-0800-C1	Electrical Components – Hardwire — Hardwire Power Kit — Single Sided for Beam	.143
VZEK-0800-C2	Electrical Components – Hardwire — Hardwire Power Kit — Double Sided for Beam	.143
VZEK-2600-C1	Electrical Components – Hardwire — Hardwire Power Kit — Single Sided for 26”(660mm)H Below WS, Connections and 42”(1067mm)H Panels at the Beltline	.141
VZEK-2600-C2	Electrical Components – Hardwire — Hardwire Power Kit — Double Sided for 26”(660mm)H Below WS, Connections and 42”(1067mm)H Panels at the Beltline	.141
VZEK-3BB	Electrical Components – Power Retrofit Kit — Raceway	.123
VZEK-42	Electrical Components – Power Retrofit Kit — 42”(1067mm)H Beltline, 58”(1473mm)H Standing Height and Connections	.120
VZEK-4BB	Electrical Components – Power Retrofit Kit — Raceway	.123
VZEK-C	Electrical Components – Hardwire — Hardwire Power Kit for Beltline, 50”H or Greater, Below WS and Standing Height	.142
VZEK-C	Electrical Components – Hardwire — Raceway Retrofit Kits	.139
VZEK-N	Electrical Components – Hardwire — Raceway Covers	.140
VZEK-NBB	Electrical Components – Raceway Covers	.124
VZEK-OB	Electrical Components – Power Retrofit Kit — Beltline, 50”(1270mm)H or Greater, Below WS and Standing Height	.121
VZEP-00	Electrical Components – Power Retrofit Kit — Standing Height	.122
VZET-2T	Electrical Components – Top Feed Module	.115
VZET-2W	Electrical Components – Top Feed Module	.115
VZET-3T	Electrical Components – Top Feed Module	.115
VZET-3TE	Electrical Components – End-of-Run Top Feed Module — Connections only	.117
VZET-3TEJ	Electrical Components – End-of-Run Top Feed Module — Beam only	.118
VZET-3W	Electrical Components – Top Feed Module	.115

Index

Product Code	Product Description	Page
VZET-3WE	Electrical Components – End-of-Run Top Feed Module — Connections only	.117
VZET-3WEJ	Electrical Components – End-of-Run Top Feed Module — Beam only	.118
VZET-4T	Electrical Components – Top Feed Module	.115
VZET-4W	Electrical Components – Top Feed Module	.115
VZET-NT	Electrical Components – Hardwire — Top Feed Module, Hardwired (Pole Only)	.137
VZET-NTEC	Electrical Components – Hardwire — End-of-Run Top Feed Module, Hardwired (Pole Only) — Connections and Below WS Power	.138
VZET-NTEJ	Electrical Components – Hardwire — End-of-Run Top Feed Module, Hardwired (Pole Only) — Beam Only	.138
VZET-NW	Electrical Components – Hardwire — Top Feed Module, Hardwired (Pole Only)	.137
VZET-NWEC	Electrical Components – Hardwire — End-of-Run Top Feed Module, Hardwired (Pole Only) — Connections and Below WS Power	.138
VZET-NWEJ	Electrical Components – Hardwire — End-of-Run Top Feed Module, Hardwired (Pole Only) — Beam Only	.138
VZFF	Structures – Full Panel Frames	.28
VZFF-NNOO	Structures – Full Panel Frames	.28
VZFI-A	High Acoustical Inserts	.40
VZFJ	Structures – Beam Frame	.37
VZFS	Panel Accessories – Stack Frame	.74
VZFS	Structures – Connections Frame	.34
VZFS	Structures – Connections Frame	.34
VZGC-000	Panel Accessories – Frameless Glass — End-of-Run Clip for use with Aluminum Bottom Rail	.83
VZGE	Panel Accessories – Bottom Rail End Cap	.83
VZGF	Structures – Glass Panels — Glass Panel	.31
VZGK	Panel Accessories – Frameless Glass and Rail Kit	.76
VZGR	Panel Accessories – Frameless Glass Bottom Rail	.81
VZGS-0000-B	Panel Accessories – Glass to Glass Connectors — Variable Height	.109
VZGS-0000-P	Panel Accessories – Glass to Glass Connectors — End-of-Run/Intersection	.109
VZGS-1616-U	Panel Accessories – Glass to Glass Connectors — In-Line	.109
VZGS-1618-1	Panel Accessories – Glass Stack	.75
VZLA-PSN	Structures – Beam Frame Leg — A Leg — In-Line and End-of-Run Condition	.39
VZLL	Structures – Beam Frame Leg — Straight Leg with Foot — In-Line and End-of-Run Condition	.38
VZLL	Structures – Connections Frame Leg — 2-, 3-, 4-Way Intersection	.36
VZLL	Structures – Connections Frame Leg — In-Line and End-of-Run Condition	.35
VZLL	Structures – Full Panel Frame Foot	.33
VZLL-PCNN	Structures – Beam Frame Leg — Straight Leg — 2-, 3-, 4-Way Intersection	.38
VZSB-0000	Panel Accessories – Seismic Anchoring Kit	.106
VZSG	Gallery Panel Accessories – Glass Topper — Gallery Panel Mounting	.201
VZSG	Panel Accessories – Alignment Clip Kit	.85
VZSG	Panel Accessories – Glass Topper	.84
VZST	Panel Accessories – Glass Topper — Bottom Rail Kit	.85
VZTI	Tiles - Full Panel, Connections and Stack Frame – Hardware Kit — Glass Tile/Open Frame Tile (10 bolts/nuts)	.64
VZTI-ADN	Compose Echo Integrated – Slotted Accessory Tile	.65
VZTI-A_N	Compose Echo Integrated – Slotted Accessory Tile	.65
VZTI-ANN	Compose Echo Integrated – Slotted Accessory Tile	.65
VZTI-D2N	Tiles - Full Panel, Connections and Stack Frame – Left and Right-Hand Port	.42
VZTI-DNN	Tiles - Full Panel, Connections and Stack Frame – No Technology Access	.42
VZTI-DNS	Tiles - Full Panel, Connections and Stack Frame – No Technology Access	.42
VZTI-DNS	Tiles - Full Panel, Connections and Stack Frame – No Technology Access	.42
VZTI-DRN	Tiles - Full Panel, Connections and Stack Frame – Right-Hand Port	.42
VZTI-FDN	Tiles - Beam – Left and Right-Hand Port	.69
VZTI-FEN	Tiles - Beam – Right-Hand Port	.69
VZTI-FNN	Tiles - Beam – No Technology Access	.69
VZTI-FNN	Tiles - Beam – No Technology Access	.69

Index

Product Code	Product Description	Page
VZTI-FNS	Tiles - Beam - No Technology Access	.69
VZTI-FWN	Tiles - Beam - Left-Hand Port	.69
VZTI-JNN	Tiles - Full Panel, Connections and Stack Frame - Slat	.62
VZTI-MNN	Tiles - Full Panel, Connections and Stack Frame - Markerboard	.61
VZTI-ONN	Tiles - Full Panel, Connections and Stack Frame - Open Frame	.63
VZTI-YNN	Tiles - Full Panel, Connections and Stack Frame - Glass	.64
VZTQ	Tiles - Full Panel, Connections and Stack Frame - Matched Natural Wood Tile Set	.59
VZVE	Panel Accessories - Variable Height Trim — Proud	.101
VZVT	Panel Accessories - Variable Height Trim 3-Way & 4-Way — Flush 90°	.102
VZVY	Panel Accessories - Variable Height Trim (Flush) — 120°	.102
VZZP	Panel Accessories - Filler Post — Sliding Door	.86
WUAR	Worksurface Accessories - Worksurface Reinforcement Channel	.263
WUAR-PHS	Worksurface Reinforcement Bar - Worksurface Reinforcement Bar	.263
WUCA-L	Adaptable Worksurfaces — Corner - General Specifications	.221
WUCA-L	Adaptable Worksurfaces — Corner - Straight Front Corner - 90°	.226
WUCB-L54	Adaptable Worksurfaces — Corner - Bent	.222
WUCB-L54	Adaptable Worksurfaces — Corner - General Specifications	.221
WUCB-R45	Adaptable Worksurfaces — Corner - Bent	.222
WUCB-R45	Adaptable Worksurfaces — Corner - General Specifications	.221
WUCC-0004	Worksurface Support - Support Column	.260
WUCD-L	Adaptable Worksurfaces — Convergent - D-Shape Convergent Wrap-Around	.240
WUCD-L	Adaptable Worksurfaces — Convergent - General Specifications	.236
WUCE-L44	Adaptable Worksurfaces — Corner - General Specifications	.221
WUCE-L44	Adaptable Worksurfaces — Corner - Wrap-Around Extended Corner - 90° — Wrap-Around Extended/ Wrap-Around Extended Transitional	.228
WUCE-R44	Adaptable Worksurfaces — Corner - General Specifications	.221
WUCE-R44	Adaptable Worksurfaces — Corner - Wrap-Around Extended Corner - 90° — Wrap-Around Extended/ Wrap-Around Extended Transitional	.228
WUCF	Adaptable Worksurfaces — Corner - Angled Corner - 90° — Angled/Angled Transitional	.235
WUCF-L45	Adaptable Worksurfaces — Corner - Angled Corner - 90° — Angled/Angled Transitional	.235
WUCF-L45	Adaptable Worksurfaces — Corner - General Specifications	.221
WUCF-L54	Adaptable Worksurfaces — Corner - General Specifications	.221
WUCH-N34	Adaptable Worksurfaces — Corner - General Specifications	.221
WUCH-N34	Adaptable Worksurfaces — Corner - Notched Corner - 90° — Notched/Notched Transitional	.232
WUCH-N43	Adaptable Worksurfaces — Corner - General Specifications	.221
WUCH-N43	Adaptable Worksurfaces — Corner - Notched Corner - 90° — Notched/Notched Transitional	.232
WUCL-0001	Worksurface Support - Straight Leg Basic — Height Adjustable	.259
WUCN	Adaptable Worksurfaces — Corner - General Specifications	.221
WUCN	Adaptable Worksurfaces — Corner - Notched Corner - 90° — Notched/Notched Transitional	.232
WUCP-L44	Adaptable Worksurfaces — Corner - General Specifications	.221
WUCP-L44	Adaptable Worksurfaces — Corner - Notched Extended Corner - 90°	.233
WUCP-R44	Adaptable Worksurfaces — Corner - General Specifications	.221
WUCP-R44	Adaptable Worksurfaces — Corner - Notched Extended Corner - 90°	.233
WUCQ-N44	Adaptable Worksurfaces — Corner - General Specifications	.221
WUCQ-N44	Adaptable Worksurfaces — Corner - Merger Corner - 90°	.225
WUCR	Adaptable Worksurfaces — Corner - General Specifications	.221
WUCR	Adaptable Worksurfaces — Corner - Wrap-Around Corner - 90° — Wrap-Around/Wrap-Around Transitional	.227
WUCT	Adaptable Worksurfaces — Corner - Wrap-Around Corner - 90° — Wrap-Around/Wrap-Around Transitional	.227
WUCT-N34	Adaptable Worksurfaces — Corner - General Specifications	.221
WUCT-N43	Adaptable Worksurfaces — Corner - General Specifications	.221
WUCU	Adaptable Worksurfaces — Corner - Angled Corner - 90° — Angled/Angled Transitional	.235
WUCU	Adaptable Worksurfaces — Corner - General Specifications	.221

Index

Product Code	Product Description	Page
WUCX-L43	Adaptable Worksurfaces — Corner – General Specifications	.221
WUCX-L43	Adaptable Worksurfaces — Corner – Wrap-Around Extended Corner – 90° — Wrap-Around Extended/ Wrap-Around Extended Transitional	.228
WUCX-R34	Adaptable Worksurfaces — Corner – General Specifications	.221
WUCX-R34	Adaptable Worksurfaces — Corner – Wrap-Around Extended Corner – 90° — Wrap-Around Extended/ Wrap-Around Extended Transitional	.228
WUCZ-N44	Adaptable Worksurfaces — Corner – General Specifications	.221
WUCZ-N44	Adaptable Worksurfaces — Corner – Wrap Around Corner – 120°	.224
WUDC	Adaptable Worksurfaces — Conference End – Conference End/Key Conference End	.245
WUDD	Adaptable Worksurfaces — Convergent – D-Shape Ender Convergent	.239
WUDD	Adaptable Worksurfaces — Convergent – General Specifications	.236
WUKC	Adaptable Worksurfaces — Adjustable Split Top – Corner — 90°	.250
WUKR	Adaptable Worksurfaces — Adjustable Split Top – Rectangular	.250
WURA	Adaptable Worksurfaces — Rectangular – General Specifications	.212
WURA	Adaptable Worksurfaces — Rectangular – Rectangular	.213
WURD	Adaptable Worksurfaces — Convergent – D-Shape Convergent	.238
WURD	Adaptable Worksurfaces — Convergent – General Specifications	.236
WURE-N34	Adaptable Worksurfaces — Rectangular – General Specifications	.212
WURE-N34	Adaptable Worksurfaces — Rectangular – Wedge/Sharp Wedge—Wedge/Sharp Wedge	.217
WURE-N43	Adaptable Worksurfaces — Rectangular – General Specifications	.212
WURE-N43	Adaptable Worksurfaces — Rectangular – Wedge/Sharp Wedge—Wedge/Sharp Wedge	.217
WURG-N34	Adaptable Worksurfaces — Rectangular – General Specifications	.212
WURG_N34	Adaptable Worksurfaces — Rectangular – Wedge/Sharp Wedge—Wedge/Sharp Wedge	.217
WURG-N43	Adaptable Worksurfaces — Rectangular – General Specifications	.212
WURG-N43	Adaptable Worksurfaces — Rectangular – Wedge/Sharp Wedge—Wedge/Sharp Wedge	.217
WURL	Adaptable Worksurfaces — Corner – 120° Rectangular Radius and Square End — 120° Rectangular Radius End/ 120° Rectangular Square End	.223
WURL	Adaptable Worksurfaces — Corner – General Specifications	.221
WURM	Adaptable Worksurfaces — Corner – 120° Rectangular Radius and Square End — 120° Rectangular Radius End/ 120° Rectangular Square End	.223
WURM	Adaptable Worksurfaces — Corner – General Specifications	.221
WURR	Adaptable Worksurfaces — Rectangular – General Specifications	.212
WURR	Adaptable Worksurfaces — Rectangular – Rectangular Radius End	.220
WURS	Adaptable Worksurfaces — Rectangular – General Specifications	.212
WURS	Adaptable Worksurfaces — Rectangular – Swell/Inverse Swell—Swell/Inverse Swell	.216
WURT-N34	Adaptable Worksurfaces — Rectangular – General Specifications	.212
WURT-N34	Adaptable Worksurfaces — Rectangular – Rectangular Transition	.215
WURT-N43	Adaptable Worksurfaces — Rectangular – General Specifications	.212
WURT-N43	Adaptable Worksurfaces — Rectangular – Rectangular Transition	.215
WURV	Adaptable Worksurfaces — Convergent – General Specifications	.236
WURV	Adaptable Worksurfaces — Convergent – Rectangular	.237
WURW	Adaptable Worksurfaces — Rectangular – General Specifications	.212
WURW	Adaptable Worksurfaces — Rectangular – Swell/Inverse Swell—Swell/Inverse Swell	.216
WURY	Adaptable Worksurfaces — Conference End – Conference End/Key Conference End	.245
WURY	Adaptable Worksurfaces — Rectangular Key	.248
WUTS	Adaptable Worksurfaces – Countertop	.249
WUYC	Adaptable Worksurfaces — Convergent – General Specifications	.236
WUYC	Adaptable Worksurfaces — Convergent – Radius Half Convergent — Rectangular/Wedge	.243
WUYF	Adaptable Worksurfaces — Convergent – General Specifications	.236
WUYF	Adaptable Worksurfaces — Convergent – Radius Half Convergent — Rectangular/Wedge	.243
WUYG	Adaptable Worksurfaces — Convergent – General Specifications	.236
WUYG	Adaptable Worksurfaces — Convergent – Radius Convergent — Radius Rectangular/Radius Wedge	.242
WUYH	Adaptable Worksurfaces — Convergent – General Specifications	.236

Index

Product Code	Product Description	Page
WUYH	Adaptable Worksurfaces — Convergent – Radius Convergent — Radius Rectangular/Radius Wedge	242
WUYP	Adaptable Worksurfaces — Triangular Key	247
WUYT	Adaptable Worksurfaces — Convergent – General Specifications	236
WUYT	Adaptable Worksurfaces — Convergent – Wedge Half Convergent Plus	244
WZDZ	Adaptable Worksurfaces — 120° Link	246
ZBA2-0000-PNFG	Worksurface Support – End Leg Kit	261
ZBA2-0030-HRFG	Worksurface Support – Return Leg Kit	261
ZBBC-0000-SN	Worksurface Support – Convergent Bracket	257
ZBBP-0000-PN	Gallery Panel Accessories – Brackets — Tie Plate	200
ZBE2-0000-PNFG	Worksurface Support – End Leg Kit	261
ZBI2-0030-HNFG	Worksurface Support – Return Leg Kit	261
ZBUF-0000-PN	Worksurface Support – Flush Mount Plate	256
ZUBW	Wall Mount Componentse – Worksurface and Gallery Panel Wall Mount Bracket	291
ZUBW-0000-CN	Worksurface Support – Gallery Panel Attachment Bracket	257
ZUBW-0000-PN	Worksurface Support – Gallery Panel Attachment Bracket	257
ZUFJ	Worksurface Support – Single Support Leg	259
ZUFS	Worksurface Support – Worksurface Support Panels	251
ZUUG	Upper Storage – Ganging Flat Bracket for Storage Box	274
ZYBD-1800	Worksurface Support – Gallery Panel Cantilever Bracket	254
ZYBT-0000-PNY	Worksurface Support – Gallery Panel Countertop/OSU Bracket Kit	258
ZYST	Gallery Panel Accessories – Topper Holder Kit	203
ZZBA	Worksurface Support – Side/Corner Bracket — 26”(660mm)H, Connections or Beam	256
ZZBA-0000-PL	Worksurface Support – Side/Corner Bracket — Full Panel	255
ZZBA-0000-PLF	Worksurface Support – Side/Corner Bracket for use with Knife Edge — Full Panel	255
ZZBA-0000-PR	Worksurface Support – Side/Corner Bracket — Full Panel	255
ZZBA-0000-PRF	Worksurface Support – Side/Corner Bracket for use with Knife Edge — Full Panel	255
ZZBD	Panel Accessories – Top Trim — Work Rail Top Trim Off-Modular Bracket	90
ZZBD	Worksurface Support – Beam Cantilever Bracket	254
ZZBD	Worksurface Support – Connections Cantilever Bracket	253
ZZBD	Worksurface Support – Standard Cantilever Bracket	253
ZZBD	Worksurface Support – Work Rail Top Trim Off-Modular Bracket	256
ZZBD-1000	Worksurface Support – Standard Mini Cantilever Bracket	253
ZZBF-0000-P	Worksurface Support – Worksurface Support Panels — Anti Dislodgement Bracket for use with Worksurface Support Panels	252
ZZBF-1000-PNA	Panel-to-Storage Bracket – A Series / Be_Hold	265
ZZBF-1600-PNA	Panel-to-Storage Bracket – A Series / Be_Hold	265
ZZBF-PLL	Panel-to-Storage Bracket – X and V Series Attached 2H Storage	265
ZZBF-PNB	Panel-to-Storage Bracket – Compose Storage	265
ZZBF-PNW	Panel-to-Storage Bracket – Beside Pantry / X and V Series Freestanding	265
ZZBL-1600	Worksurface Support – Standard Link Cantilever Bracket	255
ZZBN-0000-PNU	Panel-to-Storage Bracket – X Series – Attached Pedestal	265
ZZBP-0100-PAN	Worksurface Accessories – Stanchions	264
ZZBP-0100-PGN	Worksurface Accessories – Stanchions	264
ZZBP-0300-PAN	Worksurface Accessories – Stanchions	264
ZZBT	Worksurface Support – Countertop Bracket Kit	258
ZZFD	Worksurface Support – Double Support Leg	262
ZZFJ	Worksurface Support – P-Leg	262
ZZFJ	Worksurface Support – Support Post— Height Adjustable	260
ZZFK	Worksurface Support – Double Support Leg	262
ZZFS	Worksurface Support – Worksurface Support Panels	251

Product Compatibility and Limited Warranty Policy

Great Expectations

You have them as a Haworth customer and so do we. And because we value our customers, we cover our products with the Haworth North America Product Compatibility and Limited Warranty Policy.

Our Commitment To Product Compatibility – Integrated Product Platforms

As a market leader in the design and manufacture of workspaces that adapt to change, we strive to maintain product compatibility within our various generations of integrated product platforms. This benefits the customer who desires to update or modify their work environment. It also benefits the customer needing to replace a product due to damage or other reasons but which is no longer manufactured or is otherwise unavailable, such as a fabric or finish that is discontinued because of changing market preferences. In both circumstances, we often can provide products with comparable function and performance.

Our Commitment To Product Quality – The Haworth North America Limited Warranty

To ensure customer satisfaction and peace of mind, we stand behind our products with the Haworth North America Limited Warranty. To review the current version of the limited warranty including its terms and conditions, please go to:

www.haworth.com/warranty or contact OneTouch@Haworth.com or 1 877 429 6784.

Warranty Requests or Questions

For questions or service requests pertaining to the Haworth Limited Warranty, please contact your Haworth dealer.

If you are unsure who your dealer is, please contact **OneTouch@Haworth.com or 1 877 429 6784.**

Terms of Sale

The Terms of Sale apply to all products in the North America Price Lists. To review the current version of the North American Terms of Sale, please go to:

www.haworth.com/terms-of-sale or contact OneTouch@Haworth.com or 1 877 429 6784.

HAWORTH

HAWORTH® is a registered trademark of Haworth, Inc.

© Haworth, Inc. All rights reserved. 2025 2.25

haworth.com | 800 344 2600

Tile-to-Floor - Base Raceway Technology Access

Fabric

 VZTI-NR
 VZTI-CR
 Class BC

Unique Features

- Fabric Tiles are tackable and provide acoustical value.
- High Acoustic option available; specified separately.
- Tile-to-Floor with Base Raceway Technology Access must be used in lowest position on panel to cover base raceway power location.
- Can be shorter than full panel height or match panel height.
- Concealed Base Feed may be used with Tile-to-Floor with Base Raceway Technology Access. When applied in front of a Concealed Base Feed, Tiles must be sized and applied in a way that allows easy removal for access to base feed. A receptacle location will be taken up by the Concealed Base Feed when in use.
- **Tiles greater than 60"(1524mm)W, fabric will be railroded (RR).**
Please refer to surfaces.haworth.com for available fabric and codes.
- For aesthetic reasons, consider specifying tiles 60"(1524mm)W or less with railroded fabric if located adjacent to a tile which requires railroded fabric.

To Order, Specify:

1) Product number, including:

1 Technology Port Option:

L Left-Hand Port

R Right-Hand Port

2 Left and Right-Hand Port
 (add **\$212.90** list)

2) Fabric color.

3) Trim color for bezel.

Note: 72"(1829mm)W is not available in 64"(1626mm) and 72"(1829mm) tile height.

Nominal Height	Nominal Width	Number ①	Fabric						
			A	B	C	D	E	F	G
16"(406mm)	24"(610mm)	VZTI-1624-F ■ NR	\$ 372.43	\$ 391.95	\$ 413.38	\$ 436.79	\$ 460.21	\$ 491.36	\$ 510.86
	30"(762mm)	VZTI-1630-F ■ NR	384.69	406.06	429.56	455.20	480.87	515.01	536.35
	36"(914mm)	VZTI-1636-F ■ NR	401.94	425.19	450.74	478.62	506.54	543.65	566.84
	42"(1067mm)	VZTI-1642-F ■ NR	409.20	434.31	461.91	492.05	522.20	562.29	587.34
	48"(1219mm)	VZTI-1648-F ■ NR	421.46	448.43	478.10	510.46	542.86	585.94	612.84
	54"(1372mm)	VZTI-1654-F ■ NR	433.72	462.55	494.27	528.89	563.53	609.58	638.33
	60"(1524mm)	VZTI-1660-F ■ NR	445.97	476.67	510.44	547.31	584.19	633.22	663.82
	72"(1829mm)	VZTI-1672-F ■ NR	529.95	564.37	602.26	643.61	684.98	739.97	774.27
24"(610mm)	24"(610mm)	VZTI-2424-F ■ NR	\$ 407.72	\$ 432.61	\$459.96	\$ 489.81	\$ 519.69	\$ 559.41	\$584.26
	30"(762mm)	VZTI-2430-F ■ NR	425.22	452.77	483.06	516.11	549.19	593.17	620.66
	36"(914mm)	VZTI-2436-F ■ NR	447.72	477.94	511.17	547.41	583.70	631.93	662.06
	42"(1067mm)	VZTI-2442-F ■ NR	460.23	493.10	529.27	568.72	608.20	660.69	693.47
	48"(1219mm)	VZTI-2448-F ■ NR	477.73	513.27	552.38	595.02	637.70	694.45	729.88
	54"(1372mm)	VZTI-2454-F ■ NR	495.24	533.43	575.48	621.33	667.21	728.21	766.28
	60"(1524mm)	VZTI-2460-F ■ NR	512.74	553.59	598.58	647.63	696.71	761.97	802.68
	72"(1829mm)	VZTI-2472-F ■ NR	614.84	661.01	711.88	767.33	822.81	896.58	942.58
32"(813mm)	24"(610mm)	VZTI-3224-F ■ NR	\$ 443.01	\$ 473.27	\$506.54	\$542.83	\$ 579.17	\$ 627.46	\$ 657.66
	30"(762mm)	VZTI-3230-F ■ NR	465.75	499.48	536.56	577.02	617.51	671.33	704.97
	36"(914mm)	VZTI-3236-F ■ NR	493.50	530.69	571.60	616.20	660.86	720.21	757.28
	42"(1067mm)	VZTI-3242-F ■ NR	511.26	551.89	596.63	645.39	694.20	759.09	799.60
	48"(1219mm)	VZTI-3248-F ■ NR	534.00	578.11	626.66	679.58	732.54	802.96	846.92
	54"(1372mm)	VZTI-3254-F ■ NR	556.76	604.31	656.69	713.77	770.89	846.84	894.23
	60"(1524mm)	VZTI-3260-F ■ NR	579.51	630.51	686.72	747.95	809.23	890.72	941.54
	72"(1829mm)	VZTI-3272-F ■ NR	699.73	757.65	821.50	891.05	960.64	1053.19	1110.89

Tile-to-Floor - Base Raceway Technology Access

Nominal Height	Nominal Width	Number ①	Fabric						
			A	B	C	D	E	F	G
40"(1016mm)	24"(610mm)	VZTI-4024-F NR	\$493.29	\$528.94	\$568.11	\$610.86	\$653.65	\$710.50	\$746.06
	30"(762mm)	VZTI-4030-F NR	521.29	561.18	605.07	652.92	700.83	764.50	804.28
	36"(914mm)	VZTI-4036-F NR	554.28	598.44	647.03	699.99	753.02	823.49	867.50
	42"(1067mm)	VZTI-4042-F NR	577.28	625.69	678.98	737.07	795.20	872.48	920.73
	48"(1219mm)	VZTI-4048-F NR	605.28	657.94	715.95	779.13	842.38	926.48	978.96
	54"(1372mm)	VZTI-4054-F NR	633.28	690.19	752.90	821.21	889.57	980.47	1037.18
	60"(1524mm)	VZTI-4060-F NR	661.27	722.44	789.85	863.28	936.75	1034.46	1095.40
	72"(1829mm)	VZTI-4072-F NR	799.62	869.29	946.12	1029.77	1113.47	1224.80	1294.20
48"(1219mm)	24"(610mm)	VZTI-4824-F NR	\$513.58	\$554.60	\$599.69	\$648.88	\$698.13	\$763.55	\$804.46
	30"(762mm)	VZTI-4830-F NR	546.82	592.89	643.57	698.83	754.15	827.66	873.59
	36"(914mm)	VZTI-4836-F CR	585.06	636.19	692.46	753.78	815.18	896.77	947.72
	42"(1067mm)	VZTI-4842-F CR	613.31	669.48	731.34	798.74	866.20	955.88	1011.86
	48"(1219mm)	VZTI-4848-F CR	646.55	707.78	775.23	848.69	922.22	1019.99	1081.00
	54"(1372mm)	VZTI-4854-F CR	679.80	746.07	819.11	898.65	978.25	1084.10	1150.13
	60"(1524mm)	VZTI-4860-F CR	713.04	784.36	862.99	948.60	1034.27	1148.21	1219.26
	72"(1829mm)	VZTI-4872-F CR	869.51	950.93	1040.74	1138.49	1236.30	1366.41	1447.51
56"(1422mm)	24"(610mm)	VZTI-5624-F NR	\$548.87	\$595.26	\$646.27	\$701.90	\$757.61	\$831.60	\$877.86
	30"(762mm)	VZTI-5630-F NR	587.35	639.60	697.07	759.74	822.47	905.82	957.90
	36"(914mm)	VZTI-5636-F CR	630.84	688.94	752.89	822.57	892.34	985.05	1042.94
	42"(1067mm)	VZTI-5642-F CR	664.34	728.27	798.70	875.41	952.20	1054.28	1117.99
	48"(1219mm)	VZTI-5648-F CR	702.82	772.62	849.51	933.25	1017.06	1128.50	1198.04
	54"(1372mm)	VZTI-5654-F CR	741.32	816.95	900.32	991.09	1081.93	1202.73	1278.08
	60"(1524mm)	VZTI-5660-F CR	779.81	861.28	951.13	1048.92	1146.79	1276.96	1358.12
	72"(1829mm)	VZTI-5672-F CR	954.40	1047.57	1150.36	1262.21	1374.13	1523.02	1615.82
64"(1626mm)	24"(610mm)	VZTI-6424-F NR	\$584.15	\$635.93	\$692.84	\$754.93	\$817.09	\$899.64	\$951.26
	30"(762mm)	VZTI-6430-F NR	627.89	686.30	750.58	820.64	890.79	983.99	1042.21
	36"(914mm)	VZTI-6436-F CR	676.62	741.69	813.32	891.36	969.50	1073.33	1138.16
	42"(1067mm)	VZTI-6442-F CR	715.36	787.07	866.05	952.09	1038.20	1152.67	1224.12
	48"(1219mm)	VZTI-6448-F CR	759.10	837.45	923.80	1017.80	1111.90	1237.02	1315.08
	54"(1372mm)	VZTI-6454-F CR	802.84	887.83	981.53	1083.53	1185.61	1321.36	1406.03
	60"(1524mm)	VZTI-6460-F CR	846.57	938.21	1039.26	1149.25	1259.31	1405.70	1496.98
	72"(1829mm)	VZTI-7224-F NR	\$694.44	\$751.59	\$814.42	\$882.95	\$951.57	\$1042.69	\$1099.66
72"(1829mm)	30"(762mm)	VZTI-7230-F NR	743.42	808.01	879.08	956.55	1034.11	1137.15	1201.52
	36"(914mm)	VZTI-7236-F CR	797.40	869.44	948.75	1035.15	1121.66	1236.61	1308.38
	42"(1067mm)	VZTI-7242-F CR	841.39	920.86	1008.41	1103.76	1199.20	1326.07	1405.25
	48"(1219mm)	VZTI-7248-F CR	890.37	977.29	1073.08	1177.36	1281.74	1420.53	1507.12
	54"(1372mm)	VZTI-7254-F CR	939.36	1033.71	1137.74	1250.97	1364.29	1514.99	1608.98
	60"(1524mm)	VZTI-7260-F CR	988.34	1090.13	1202.40	1324.57	1446.83	1609.45	1710.84

Electrical Components

Hardware

End-of-Run Top Feed Module, Hardwired (Pole Only) — Full Panel Below WS and Raceway Power

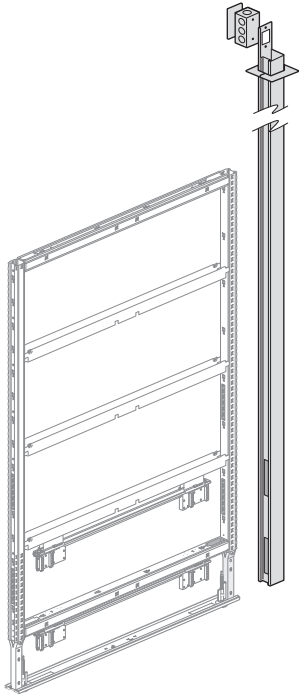

VZET-NTEJ
VZET-NWEJ



Class BC

Features

- Includes one electrical box, ceiling bezel plate, pole and hardware.
- For connection to the electrical source located in space above a drop ceiling.
- Removable cover on poles provides access to pathway.
- Pole longer than 120" (3048mm) will consist of two sections.

Specification Tips

- For routing and cabling capacities, see Specification Guide.
- Mounts to the end of the frame replacing end-of-run trim.
- Specification of end-of-run trim not necessary when using End-of-Run Top Feed.
- Not for use with 2-way, 3-way or 4-way applications.
- Application may require approval of local authority having jurisdiction (AHJ); ensure compliance before placing orders and installation.
- For use with full panel for below worksurface and raceway power.

To Order, Specify:

- 1) Product number.
- 2) Trim color.

Pole Length	Number	Trim	
		A	B
9.5' Ceiling Height			
120" (3048mm)	VZET-OR00-NTEJ	\$1353.42	\$1575.39
9.5'-12' Ceiling Height			
148" (3759mm)	VZET-OR00-NWEJ	\$1396.20	\$1651.29