

HAWORTH

Electrical Accessories

North America Price List – February 2025





This Haworth North American price book contains US list prices.

Canadian customers can convert the US list price into their Canadian equivalent by going to www.Haworth.com/Canada to find the current Canadian multipliers. These multiplier factors allow you to convert the US list price into a Canadian list price.

Haworth Price List Overview

Tips for Using Haworth Price Books

The following overview explains how information is organized within the Electrical Accessories price book (includes Belong™ Electrical Components).

Navigation Links

Use the links to jump back and forth to relevant pages.

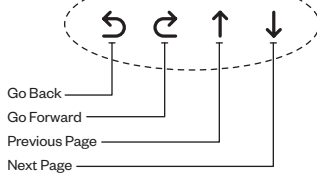

Go Back
Go Forward
Previous Page
Next Page

Go Back

Go Forward

Previous Page

Next Page

Navigation Links

Use the links to jump back and forth to relevant pages.

Navigation Links

Use the links to jump back and forth to relevant pages.

Navigation Links

Use the links to jump back and forth to relevant pages.

Haworth Price Books are organized into the following sections:

Price List Section

Statement of Line

Price List

Statement of Line
Provides a visual overview of the product offering.

Price List
Includes product features, specification tips, catalog numbers and list pricing.

Resources Section

Surface Materials

Index

Product Compatibility and Limited Warranty Policy

Warranty and Terms of Sale

Finishes and Fabrics
Lists available product finishes and fabrics.

Index
Lists products alphabetically by catalog number.

Warranty and Terms of Sale
Provides warranty information and general terms.

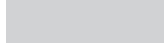

This Page Intentionally Left Blank

Electrical Accessories Price List

Includes pricing, catalog numbers, finish codes/availability, specification requirements, line art, dimensions, and specification tips for Electrical Accessories.

Worksurface Power Modules

Worksurface Power Modules - Enhanced Power

Worksurface Power Modules - Classic Power

Worksurface Power Modules - Flip Top

Worksurface Power Modules - Flush Mounted Power

Worksurface Power Modules - Power Tap

Worksurface Power Modules - Other Power and Data

Wire/Cable Management - Horizontal

Wire/Cable Management - Vertical

Wire/Cable Management Accessories

Table of Contents

Price List

Statement of Line	7
Worksurface Power Modules	
Belong Power 65W — Power Cube	14
Belong Power 65W — Plug Strip	14
Belong Power 65W — Power Suite	15
Belong Power 65W — Plug Strip Brackets	16
Power Cube	17
Belong — Plug Strip	17
Belong — Power Suite	17
Power Cube and Power Suite — Brackets	18
Wireless Charging Module	19
Worksurface Power Modules — Enhanced Power	
Seamless	20
Corded	23
Hardwire	28
Spiral Corded — Height Adjustable	33
Cord for Height Adjustable	34
Brackets — Above Worksurface - Adjustable	35
Brackets — Above Worksurface - Adjustable for Knife Edge	35
Brackets — Above Worksurface - Adjustable with Tackboard Offset	36
Brackets — Above Worksurface - Fixed	36
Brackets — Under Worksurface - Fixed	37
Brackets — For Use with X Series	37
Worksurface Power Modules — Classic Power	
Classic Power Module	38
Brackets — Angled	39
Brackets — Vertical	39
Brackets — Under Surface	39
Worksurface Power Modules — Flip Top	
Smooth Bezel - Corded - Single-Sided — Power, Data and USB	40
Smooth Bezel — Corded — Double-Sided — Power, Data and USB	43
Smooth Bezel — Hardwire — Single-Sided — Power, Data and USB	46
Smooth Bezel — Hardwire — Double-Sided — Power, Data and USB	49
Power and Data	52
Non-Powered	53
Corded - Single-Sided — Power, Data and USB	54
Corded — Double-Sided — Power, Data and USB	59
Hardwire — Single-Sided — Power, Data and USB	64
Hardwire — Double-Sided — Power, Data and USB	69
Worksurface Power Modules — Flush Mounted Power	
Corded	74
Hardwire	77
Spiral Cord for Height Adjustable	80
Worksurface Power Modules—Flush Mounted Power	83
Round	86
Worksurface Power Modules — Power Tap	
Horizontal	87
Vertical	88
Hardwire and Corded — Hardwire	89
Hardwire and Corded — Corded	89
Brackets — Fixed	90
Brackets — Adjustable	90
Brackets — Under Surface	90
Brackets — Bracket with Grommet	90
Worksurface Power Modules — Other Power and Data	
Data Bezel	91
Bezel Utility Module	91
Collaborative Power Station	92
Retrofit USB Charging Cable	93
Cables	93

Wire/Cable Management — Horizontal

Wire Management Tray — General Specifications	94
Wire Management Tray	95
Wire Management Basket	96
Basket Cover	96
Height Adjustable Table	96
Wire Manager — Horizontal	96
J-Channel	97
Horizontal Wire Management	97

Wire/Cable Management — Vertical

Cord Management Cuff	98
Mesh Cord Manager with Cuffs	98
Mesh Cord Manager Bracket	98
Vertical Wire Channel - Leg Attached	99
Vertical Cable Guide	99
Wire Manager — Vertical	99

Wire/Cable Management Accessories

Clips — Conduit Clamp	100
Clips — Wire Management Loop	100
Clips — Wire Manager Clips	100
Belong Hatch	101
Belong Hatch Planning Guidelines	102
Grommets	103
Grommets — Flip Top Unit — Hatch	104

Resources

Surface Materials

Finish/Color Legend	106
---------------------------	-----

Index	107-109
--------------------	---------

Lifetime Product Warranty	Inside Back Cover
--	-------------------

Statement of Line

Worksurface Power Modules – Belong Power 65W

Pages 14-16

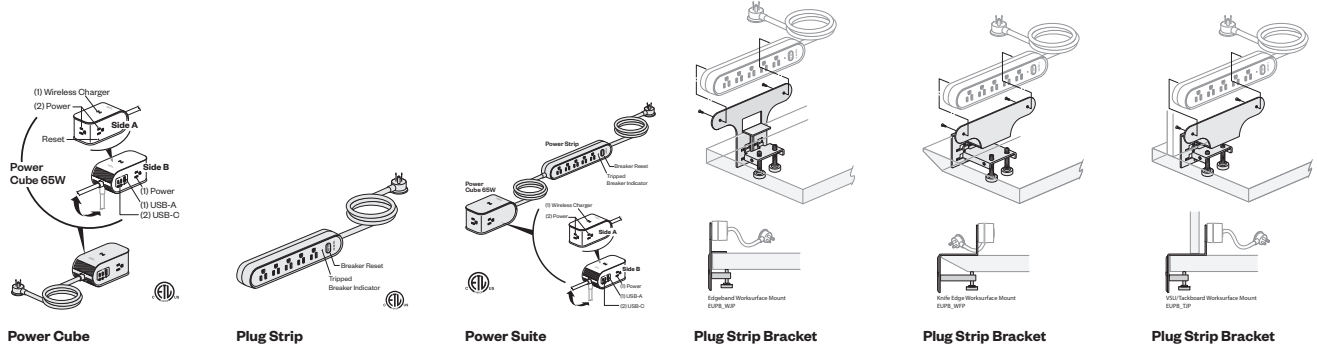

Worksurface Power Modules

Pages 17-19

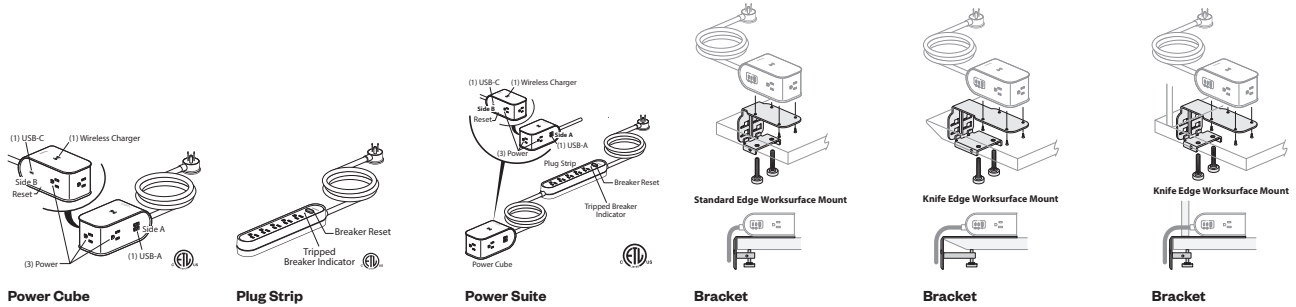

EUWC-PFOB-12002

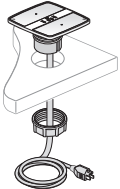

Wireless Charging Module

Worksurface Power Modules – Enhanced Power

Pages 20-37

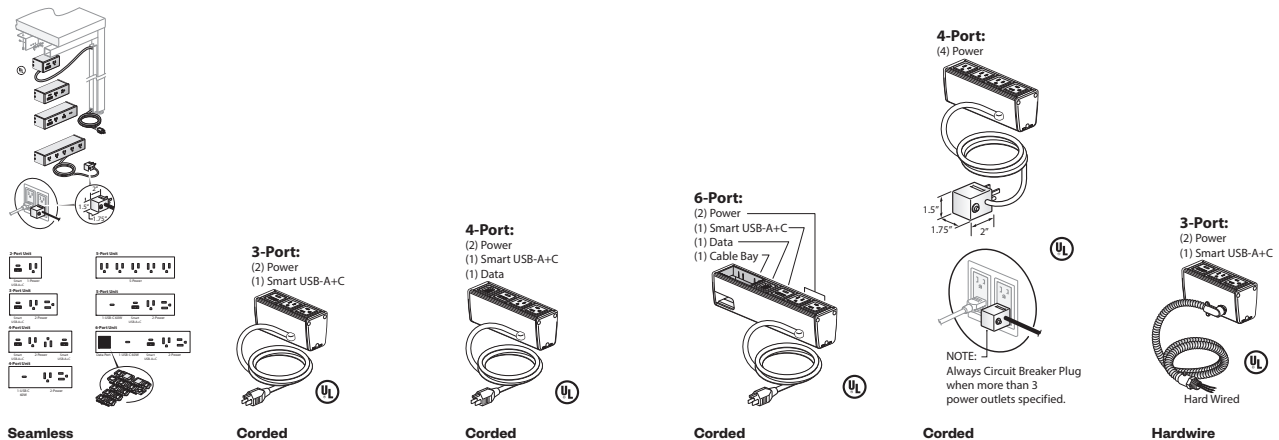

Statement of Line

Worksurface Power Modules – Enhanced Power, (cont'd)

Pages 20-37

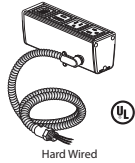
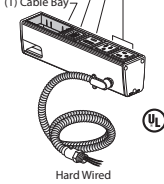
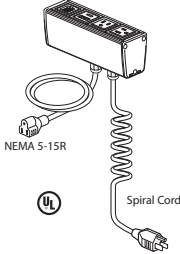
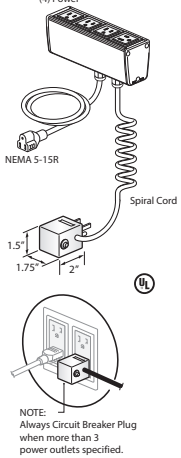
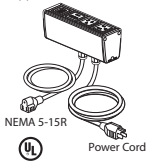
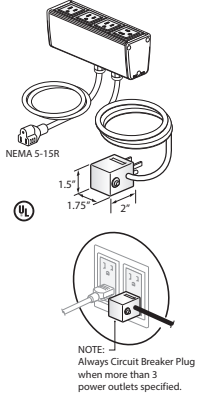
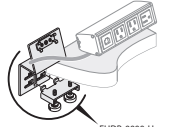
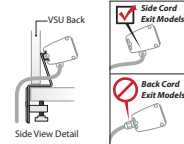
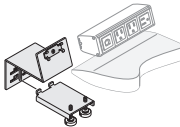
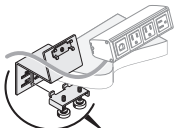
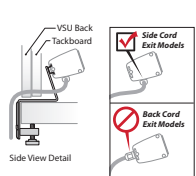
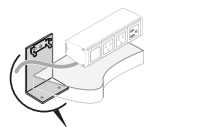
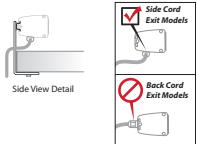
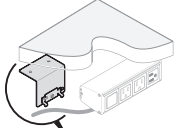
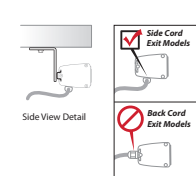
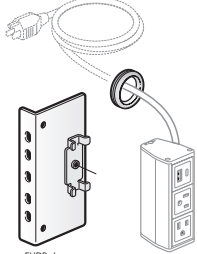
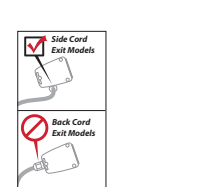
<p>4-Port: (2) Power (1) Smart USB-A+C (1) Data</p>  <p>Hard Wired</p>	<p>6-Port: (2) Power (1) Smart USB-A+C (1) Data (1) Cable Bay</p>  <p>Hard Wired</p>	<p>4-Port: (2) Power (1) Smart USB-A+C (1) Data</p>  <p>Spiral Corded Height Adjustable</p>	<p>4-Port: (4) Power</p>  <p>NEMA 5-15R Spiral Cord</p> <p>NOTE: Always Circuit Breaker Plug when more than 3 power outlets specified.</p> <p>Spiral Corded Height Adjustable</p>	<p>4-Port: (2) Power (1) Smart USB-A+C (1) Data</p>  <p>Power Cord</p> <p>Cord for Height Adjustable</p>	<p>4-Port: (4) Power</p>  <p>NEMA 5-15R Power Cord</p> <p>NOTE: Always Circuit Breaker Plug when more than 3 power outlets specified.</p> <p>Cord for Height Adjustable</p>
 <p>EUIDB-0000-H</p>  <p>Side View Detail</p> <p>VSU Back</p> <p>Side Cord Exit Models</p> <p>Back Cord Exit Models</p>	 <p>EUIDB-0000-NB</p> <p>Side View Detail</p> <p>VSU Back Tackboard</p> <p>Side Cord Exit Models</p> <p>Back Cord Exit Models</p>	 <p>EUIDB-0000-T</p>  <p>Side View Detail</p> <p>VSU Back Tackboard</p> <p>Side Cord Exit Models</p> <p>Back Cord Exit Models</p>	 <p>EUIDB-0000-W</p>  <p>Side View Detail</p> <p>Side Cord Exit Models</p> <p>Back Cord Exit Models</p>	 <p>EUIDB-0000-U</p>  <p>Side View Detail</p> <p>Side Cord Exit Models</p> <p>Back Cord Exit Models</p>	 <p>EUIDB-J</p>  <p>Side View Detail</p> <p>Side Cord Exit Models</p> <p>Back Cord Exit Models</p>
<p>Above Worksurface Adjustable Bracket</p>	<p>Above Worksurface Adjustable for Knife Edge Bracket</p>	<p>Above Worksurface Adjustable with Tackboard Offset Bracket</p>	<p>Above Worksurface Adjustable Fixed Bracket</p>	<p>Under Worksurface Fixed Bracket</p>	<p>For Use with X Series Bracket</p>

Worksurface Power Modules – Classic Power

Pages 38-39

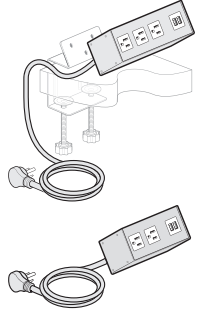
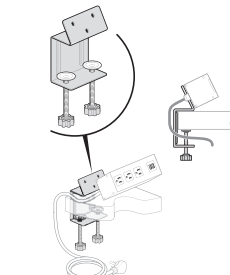
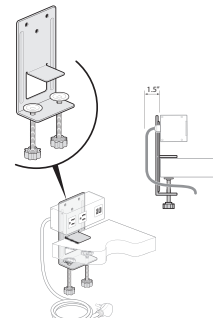
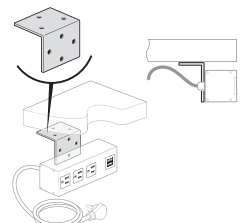
 <p>Classic Power Module</p>	 <p>Angled Bracket</p>	 <p>Vertical Bracket</p>	 <p>Under Surface Bracket</p>
---	---	---	---

Statement of Line

Worksurface Power Modules – Flip Top

Pages 40-69

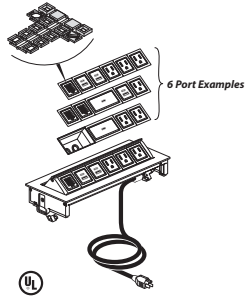

**Smooth Bezel
Corded
Single-Sided
Power, Data and USB**

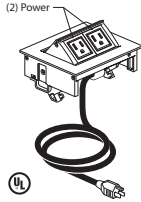

**Smooth Bezel
Corded
Single-Sided
Power, Data and USB**

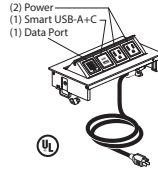

**Smooth Bezel
Corded
Single-Sided
Power, Data and USB**

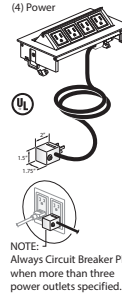

**Smooth Bezel
Corded
Single-Sided
Power, Data and USB**

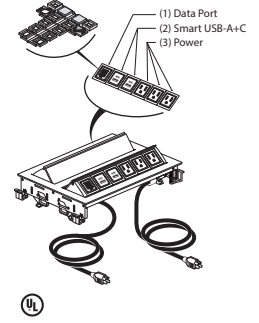

**Smooth Bezel
Corded
Double-Sided
Power, Data and USB**

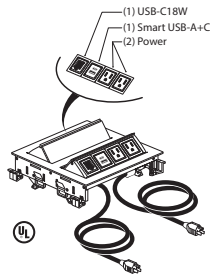

**Smooth Bezel
Corded
Double-Sided
Power, Data and USB**

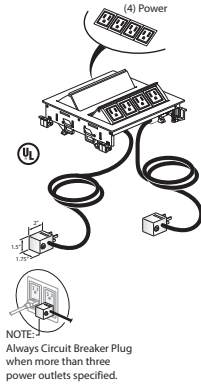

**Smooth Bezel
Corded
Double-Sided
Power, Data and USB**

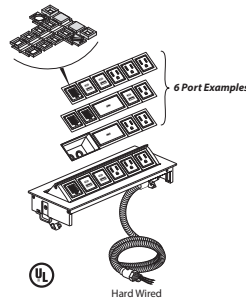

**Smooth Bezel
Hardwire
Single-Sided
Power, Data and USB**

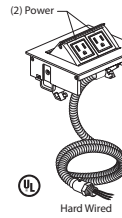

**Smooth Bezel
Hardwire
Single-Sided
Power, Data and USB**

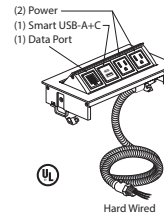

**Smooth Bezel
Hardwire
Single-Sided
Power, Data and USB**

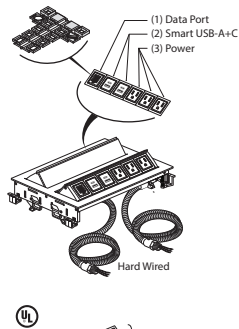

**Smooth Bezel
Hardwire
Double-Sided
Power, Data and USB**

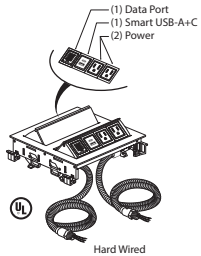

**Smooth Bezel
Hardwire
Double-Sided
Power, Data and USB**



Power and Data



Power and Data

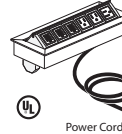

Power and Data

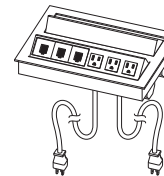

Power and Data

Statement of Line

Worksurface Power Modules – Flip Top, (cont'd)



Pages 40-69

Power and Data	Power and Data	Power and Data	Non-Powered	Non-Powered
<p>4-Port: (2) Power (1) Smart USB-A+C (1) Data</p>	<p>6-Port: (4) Power (1) Smart USB-A+C (1) Data</p> <p>NOTE: Always Circuit Breaker Plug when more than three power outlets specified.</p>	<p>4-Port: (4) Power</p> <p>NOTE: Always Circuit Breaker Plug when more than three power outlets specified.</p>	<p>(1) Data Port (1) Smart USB-A+C (3) Power</p>	<p>(2) Data Port (1) Smart USB-A+C (3) Power</p>
Corded Single-Sided Power, Data and USB	Corded Single-Sided Power, Data and USB	Corded Single-Sided Power, Data and USB	Corded Double-Sided Power, Data and USB	Corded Double-Sided Power, Data and USB
<p>(4) Power</p> <p>NOTE: Always Circuit Breaker Plug when more than three power outlets specified.</p>	<p>4-Port: (2) Power (1) Smart USB-A+C (1) Data</p>	<p>6-Port: (3) Power (1) Smart USB-A+C (2) Data</p>	<p>4 Port: (1) Data Port (1) Smart USB-A+C (2) Power</p>	<p>(2) Data Port (1) Smart USB-A+C (3) Power</p>
Corded Double-Sided Power, Data and USB	Hardwire Single-Sided Power, Data and USB	Hardwire Single-Sided Power, Data and USB	Hardwire Double-Sided Power, Data and USB	Hardwire Double-Sided Power, Data and USB

Statement of Line

Worksurface Power Modules – Flush Mounted Power

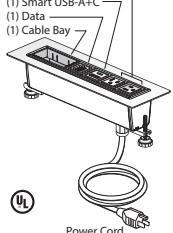
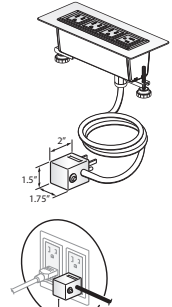
Pages 74-86

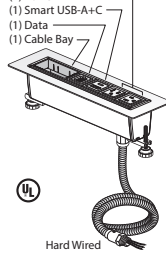
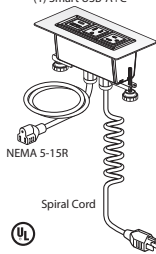
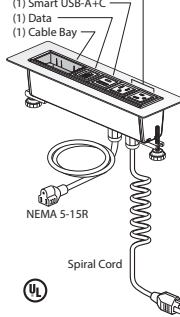
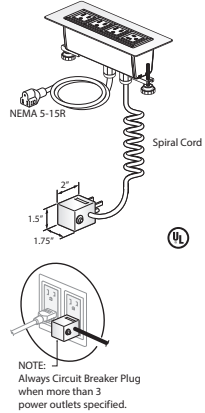
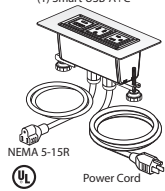
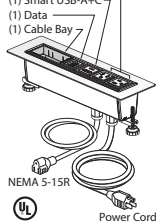
<p>3-Port: (2) Power (1) Smart USB-A+C</p>  <p>UL Power Cord</p> <p>Corded</p>	<p>4-Port: (2) Power (1) Smart USB-A+C (1) Data</p>  <p>UL Power Cord</p> <p>Corded</p>	<p>6-Port: (2) Power (1) Smart USB-A+C (1) Data (1) Cable Bay</p>  <p>UL Power Cord</p> <p>Corded</p>	<p>4-Port: (4) Power</p>  <p>NOTE: Always Circuit Breaker Plug when more than 3 power outlets specified.</p> <p>UL Power Cord</p> <p>Corded</p>	<p>3-Port: (2) Power (1) Smart USB-A+C</p>  <p>UL Hard Wired</p> <p>Hardwire</p>	<p>4-Port: (2) Power (1) Smart USB-A+C (1) Data</p>  <p>UL Hard Wired</p> <p>Hardwire</p>
<p>6-Port: (2) Power (1) Smart USB-A+C (1) Data (1) Cable Bay</p>  <p>UL Hard Wired</p> <p>Hardwire</p>	<p>3-Port: (2) Power (1) Smart USB-A+C</p>  <p>NEMA 5-15R Spiral Cord</p> <p>UL</p> <p>Spiral Cord for Height Adjustable</p>	<p>4-Port: (2) Power (1) Smart USB-A+C (1) Data</p>  <p>NEMA 5-15R Spiral Cord</p> <p>UL</p> <p>Spiral Cord for Height Adjustable</p>	<p>6-Port: (2) Power (1) Smart USB-A+C (1) Data (1) Cable Bay</p>  <p>NEMA 5-15R Spiral Cord</p> <p>UL</p> <p>Spiral Cord for Height Adjustable</p>	<p>4-Port: (4) Power</p>  <p>NOTE: Always Circuit Breaker Plug when more than 3 power outlets specified.</p> <p>UL Spiral Cord</p> <p>Spiral Cord for Height Adjustable</p>	<p>3-Port: (2) Power (1) Smart USB-A+C</p>  <p>NEMA 5-15R Power Cord</p> <p>UL</p> <p>Cord for Height Adjustable</p>
<p>4-Port: (2) Power (1) Smart USB-A+C (1) Data</p>  <p>NEMA 5-15R Power Cord</p> <p>UL</p> <p>Cord for Height Adjustable</p>	<p>6-Port: (2) Power (1) Smart USB-A+C (1) Data (1) Cable Bay</p>  <p>NEMA 5-15R Power Cord</p> <p>UL</p> <p>Cord for Height Adjustable</p>	<p>4-Port: (4) Power</p>  <p>NOTE: Always Circuit Breaker Plug when more than 3 power outlets specified.</p> <p>UL Power Cord</p> <p>Cord for Height Adjustable</p>	<p>Round</p>  <p>Data Port Adapters (1) Data Port (1) Power Receptacle (EUP1) Flush Mount-Round 3" dia. 1.5" Max. Thickness (Corded) (Hardwired)</p>		

Statement of Line

Worksurface Power Modules – Power Tap

Pages 87-90

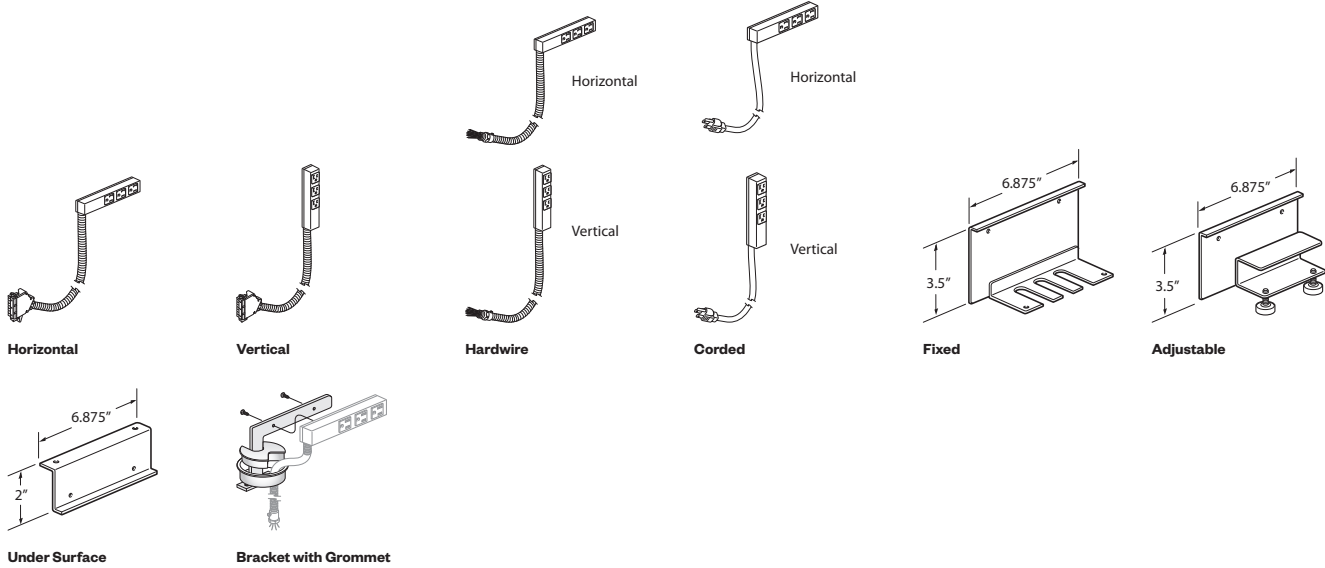

Worksurface Power Modules – Other Power and Data

Pages 91-93

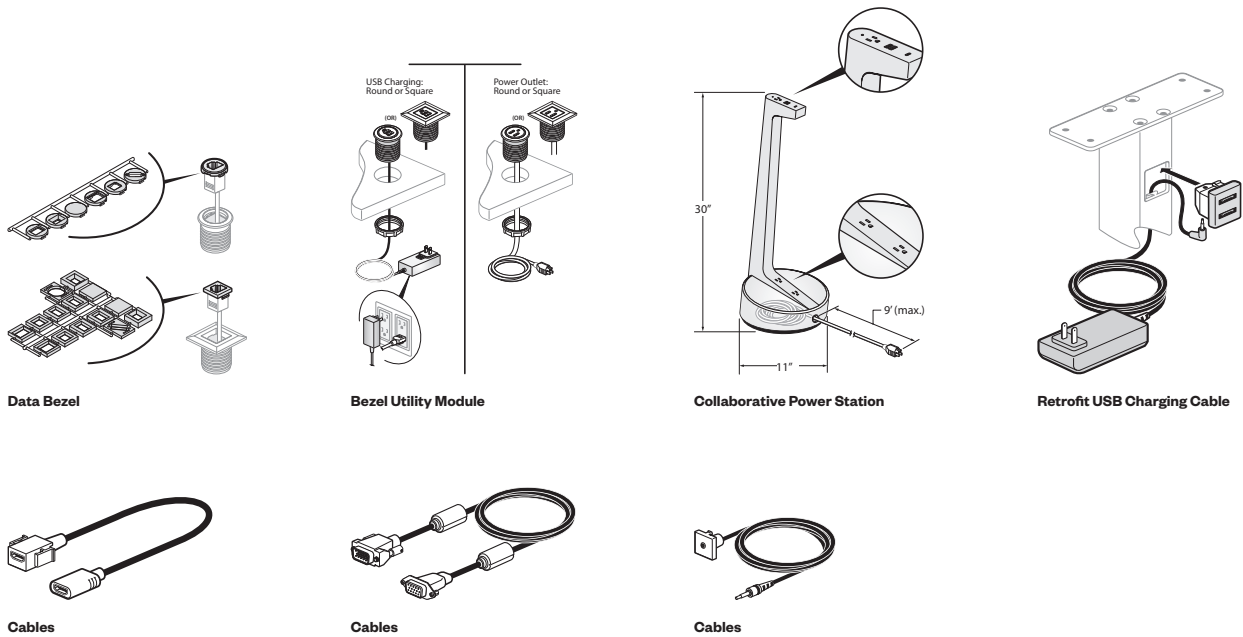

Statement of Line

Wire/Cable Management — Horizontal

Pages 94-97

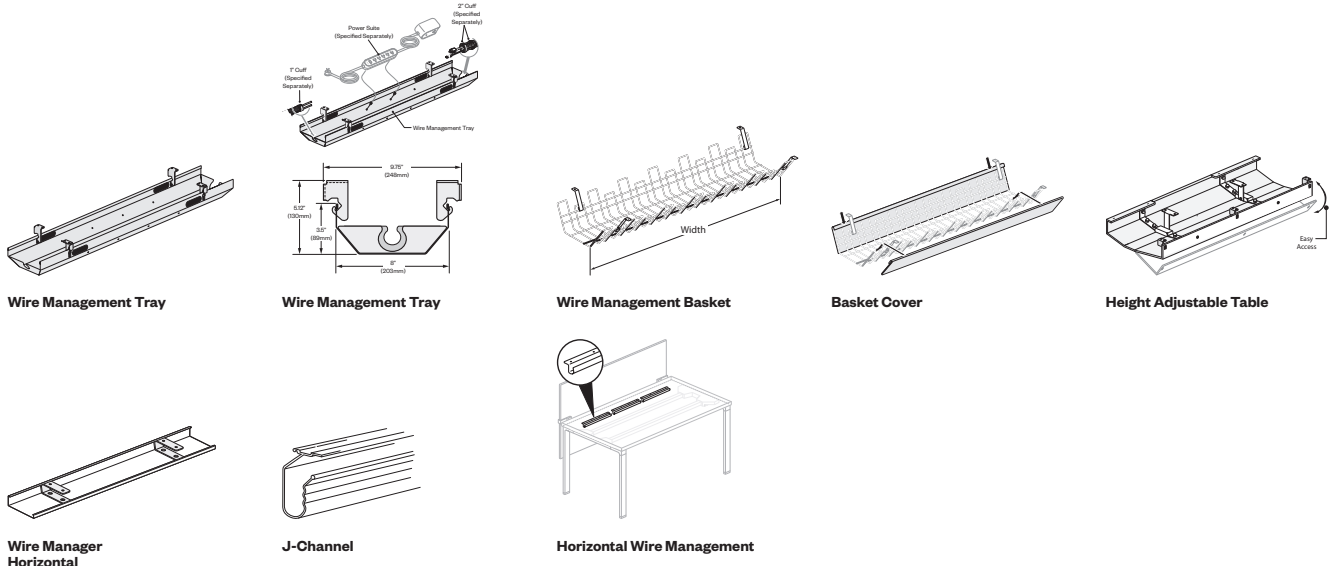

Wire/Cable Management — Vertical

Pages 98-99

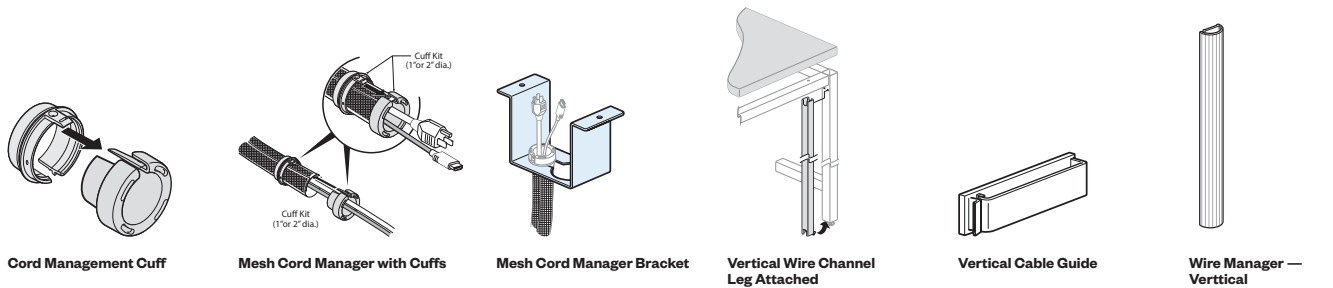

Wire/Cable Management Accessories

Pages 100-104

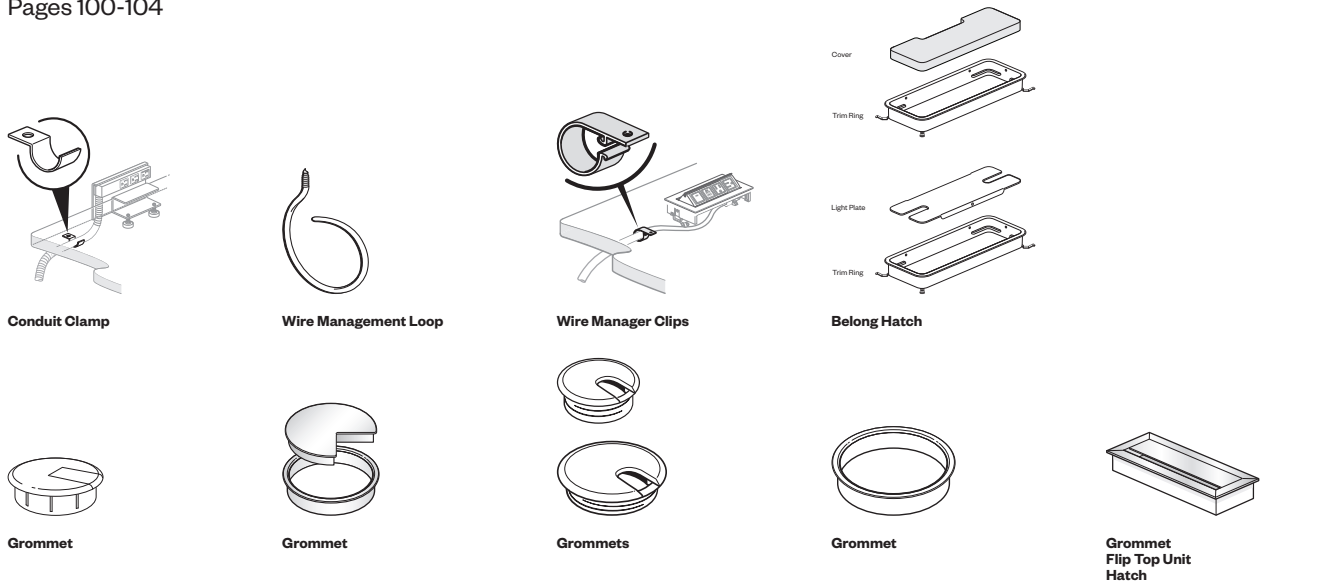

Worksurface Power Modules

Belong Power 65W

Power Cube

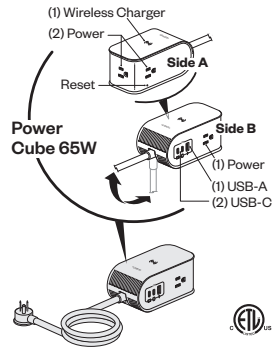

EUC4-BIN1
Class YA – GSA: Open Market

Features

- Includes six power cubes, each with three 120V receptacles (NEMA 5-15R), one USB-A charging port, two USB-C charging ports, one wireless charger, circuit breaker with reset pin hole, and 9’(2743mm) hinged braided power cord with low profile plug (NEMA 5-15P).
- Can be freestanding on worksurface or be used with appropriate mounting bracket.
- 15W (wireless) charging coil on top of cube.
- USB-A and USB-C offer rapid charging capability for a variety of devices.
- USB-A provides single port max charging 60W.
- Each USB-C provides single port max charging 65W.
- Available in charcoal TR-K or snow TR-FM.
- Power Cube has non-slip pad on bottom.
- UL 962A listed Furniture Power Distribution Unit.

Specification Tips

- For additional information on charging refer to the Belong Power 65W charging guide on haworth.com.
- Brackets (EUCB) are optional and can be separately specified.
- Belong Power Units, (Power Suite, Power Cube and Plug Strip), are not designed or UL/CSA listed for daisy-chain applications.
- Application may require approval of local authority having jurisdiction (AHJ); ensure compliance before placing orders and installation.

To Order, Specify:

- 1) Product number.
- 2) Trim color.
TR-K Charcoal
TR-FM Snow

Description	Number	Price
Pack of 6	EUC4-BIN1-31020YN	\$2370.00

Plug Strip

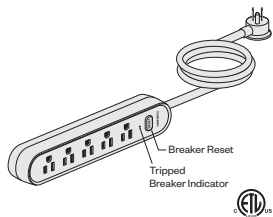

EUR1-BIN1
Class YA – GSA: Open Market

Features

- Includes six plug strips, each with five 120V receptacles (NEMA 5-15R), circuit breaker with a reset indicator light, and 9’(2743mm) braided power cord with low profile plug (NEMA 5-15P).
- Plug Strip can mount in wire management tray or mount directly to the underside of the worksurface without additional bracket.
- Plug Strip has keyhole slots for mounting below worksurface or can be mounted to the back edge of the worksurface using separately specified Plug Strip Brackets (EUPB).
- Available in charcoal TR-K or snow TR-FM.
- UL 962A listed Furniture Power Distribution Unit.

Specification Tips

- Recommended for 23”(584mm)D surfaces which cannot accommodate a wire management tray.
- Belong Power Units, (Power Suite, Power Cube and Plug Strip), are not designed or UL/CSA listed for daisy-chain applications.
- Application may require approval of local authority having jurisdiction (AHJ); ensure compliance before placing orders and installation.

To Order, Specify:

- 1) Product number.
- 2) Trim color.
TR-K Charcoal
TR-FM Snow

Description	Number	Price
Pack of 6	EUR1-BIN1-50000M	\$490.50

Worksurface Power Modules

Belong Power 65W

Power Suite

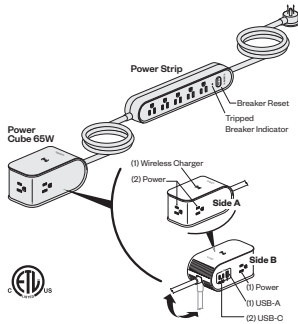

EUB5-BIN1
Class YA - GSA: Open Market

Features

- Includes six power suites, each with three 120V receptacles (NEMA 5-15R), one USB-A charging port, two USB-C charging ports, one wireless charger, one connected plug strip with five 120V receptacles (NEMA 5-15R), circuit breaker, and 9'(2743mm) hinged braided power cord with low profile plug (NEMA 5-15P).
- Cord connecting plug strip to power cube is 4'(1219mm).
- Power Cube can be freestanding on worksurface or be used with appropriate mounting bracket. Plug strip can mount in wire management tray or mount directly to the underside of the worksurface without additional bracket.
- Available in charcoal TR-K or snow TR-FM.
- Power Cube includes:
 - 15W (wireless) charging coil on top of cube.
 - USB-A and USB-C offer rapid charging capability for a variety of devices.
 - USB-A provides single port max charging 60W.
 - Each USB-C provides single port max charging 65W.
 - Non-slip pad on bottom.
- Power Cube included with the Power Suite does not include the reset feature.
- Plug Strip includes:
 - Circuit breaker with a reset indicator light.
 - Keyhole slots for mounting below worksurface.
- UL 962A listed Furniture Power Distribution Unit.

Specification Tips

- Plug Strip designed to be mounted below worksurface for long term connection. Power Cube is mounted above the surface for a convenient power option.
- Recommended for 23"(584mm)D surfaces which cannot accommodate a wire management tray.
- Belong Power Units, (Power Suite, Power Cube and Plug Strip), are not designed or UL/CSA listed for daisy-chain applications.
- Application may require approval of local authority having jurisdiction (AHJ); ensure compliance before placing orders and installation.

To Order, Specify:

- 1) Product number.
- 2) Trim color.
 - TR-K Charcoal
 - TR-FM Snow

Description	Number	Price
Pack of 6	EUB5-BIN1-81020YN	\$3150.00

Worksurface Power Modules

Belong Power 65W

Plug Strip Brackets

Features

- Includes one mounting bracket and thumb screws.
- For use with Belong Plug Strip only.
- Available in standard finishes.

Specification Tips

- Accommodates 1.18"(30mm) - 2"(51mm) thick tops.
- Adjustable bracket mounts Belong Plug Strip to the edge of worksurface with thumb screws for ease of relocation.
- To mount plug strip to the bracket, use hardware provided with the plug strip.
- Not for use with Intuity hatches.
- Application may require approval of local authority having jurisdiction (AHJ); ensure compliance before placing orders and installation.

To Order, Specify:

- 1) Product number.
- 2) Trim color.

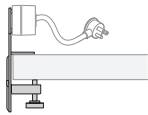
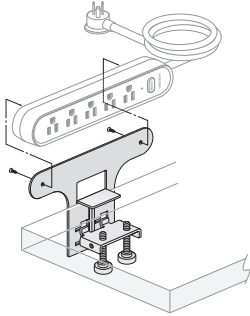

Edgeband Worksurface Mount
EUPB_WJP

EUPB-WJP

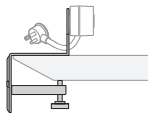
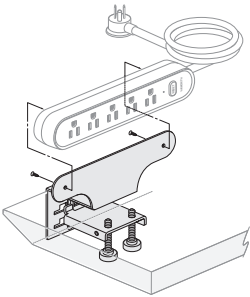

Knife Edge Worksurface Mount
EUPB_WFP

EUPB-WFP

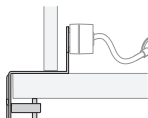
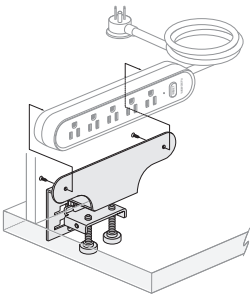

VSU/Tackboard Worksurface Mount
EUPB_TJP

EUPB-TJP

Class YA - GSA: Open Market

Description

Description	Number	Price
Edgeband	EUPB-0000-WJP	\$ 85.00
Knife Edge	EUPB-0000-WFP	130.00
VSU/Tackboard	EUPB-0000-TJP	120.00

Worksurface Power Modules

Power Cube

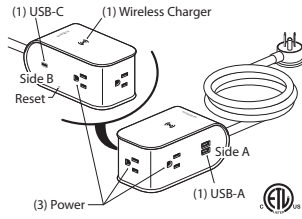

EUC4
Class YA – GSA: Open Market

Features

- Includes one power module with three 120V receptacles (NEMA 5-15R), one dual USB-A charging port, one USB-C charging port, one wireless charger, and 9'(2743mm) hinged braided power cord with low profile plug (NEMA 5-15P).
- Can be freestanding on worksurface or be used with appropriate mounting bracket.
- 10W (wireless) charging coil on top of cube.
- USB-A and USB-C share 15W charging capability.
- USB-A provides two ports.
- USB-C provides one port for fast charge for a mobile phone.
- Power Cube has non-slip pad on bottom.

Specification Tips

- Available in charcoal TR-K or snow TR-FM.
- Brackets (EUCB) are optional and can be separately specified.
- Application may require approval of local authority having jurisdiction (AHJ); ensure compliance before placing orders and installation.

To Order, Specify:

- 1) Product number.
- 2) Trim color.
TR-K Charcoal
TR-FM Snow

Number	Price
EUC4-BINI-31100YN	\$349.07

Plug Strip

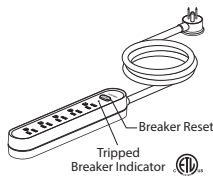

EUR1
Class YA – GSA: Open Market

Features

- Includes one plug strip with five 120V receptacles (NEMA 5-15R), circuit breaker, and 9'(2743mm) braided power cord with low profile plug (NEMA 5-15P).
- Plug Strip can mount in wire management tray or mount directly to the underside of the worksurface without additional bracket.
- Plug Strip has keyhole slots for mounting below worksurface.
- UL 962A listed Furniture Power Distribution Unit.

Specification Tips

- Available in charcoal TR-K or snow TR-FM.
- Recommended for 23"(584mm)D surfaces which cannot accommodate a wire management tray.
- Application may require approval of local authority having jurisdiction (AHJ); ensure compliance before placing orders and installation.

To Order, Specify:

- 1) Product number.
- 2) Trim color.
TR-K Charcoal
TR-FM Snow

Number	Price
EUR1-BINI-50000	\$85.84

Power Suite

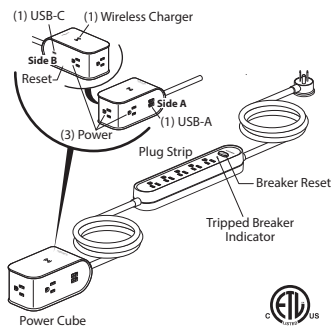

EUB5
Class YA – GSA: Open Market

Features

- Includes one power module with three 120V receptacles (NEMA 5-15R), one dual USB-A charging port, one USB-C charging port, one wireless charger, one connected plug strip with five 120V receptacles (NEMA 5-15R), circuit breaker, and 9'(2743mm) hinged braided power cord with low profile plug (NEMA 5-15P).
- Cord connecting plug strip to power cube is 4'(1219mm).
- Power Cube can be freestanding on worksurface or be used with appropriate mounting bracket. Plug strip can mount in wire management tray or mount directly to the underside of the worksurface without additional bracket.
- 10W (wireless) charging coil on top of cube.
- USB-A and USB-C share 15W charging capability.
- USB-A provides two ports.
- USB-C provides one port for fast charge for a mobile phone.
- Power Cube has non-slip pad on bottom.
- Plug Strip has keyhole slots for mounting below worksurface.
- Circuit breaker has a reset indicator light.

Specification Tips

- Available in charcoal TR-K or snow TR-FM.
- Plug Strip designed to be mounted below worksurface for long term connection. Power Cube is mounted above the surface for a convenient power option.
- Recommended for 23"(584mm)D surfaces which cannot accommodate a wire management tray.
- Application may require approval of local authority having jurisdiction (AHJ); ensure compliance before placing orders and installation.

To Order, Specify:

- 1) Product number.
- 2) Trim color.
TR-K Charcoal
TR-FM Snow

Number	Price
EUB5-BINI-81100YN	\$406.30

Worksurface Power Modules

Power Cube and Power Suite

Brackets

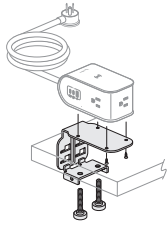

Standard Edge Worksurface Mount



EUCB-WJP

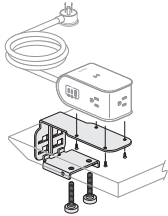

Knife Edge Worksurface Mount

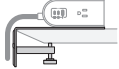

EUCB-WFP

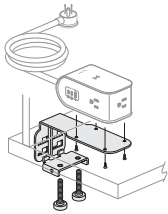

Knife Edge Worksurface Mount



EUCB-TJP

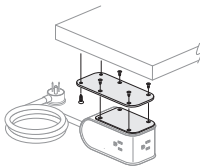

Under Worksurface Mount

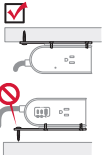

Above Worksurface Application
(Bracket NOT Fastened or Needed)

EUUB-UP

Class YA – GSA: Open Market

Features

- Includes mounting bracket and mounting hardware.
- For use with Belong Power Solutions cube and suite. Not for use with the Power Strip.

Specification Tips

- Accommodates 1.18”(30mm) thick tops with clear space below.
- Available in standard finishes.
- Application may require approval of local authority having jurisdiction (AHJ); ensure compliance before placing orders and installation.

To Order, Specify:

- 1) Product number.
- 2) Trim color.
TR-K Charcoal
TR-FM Snow

Description

Description	Number	Price
Edgeband	EUCB-0000-WJP	\$ 57.23
Knife Edge	EUCB-0000-WFP	131.62
VSU/Tackboard	EUCB-0000-TJP	57.23
Undersurface	EUUB-0503-UP	28.61

Worksurface Power Modules

Wireless Charging Module

EUWC-PFOB-12002

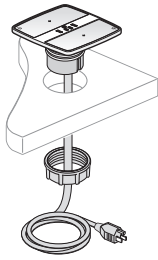

EUWC-PFOB
EUWC-PFOW
EUWC-HLOB
EUWC-HLOW



Class YA - GSA: Open Market

Features

- Includes power module with simplex outlet (NEMA-15R), two USB charging simplex and two charging Qi pads with soft touch plastic inserts and mounting hardware.
- 5 Watt Qi charging coil.
- Corded power module with 15 amp - 6'(1829mm) or 12'(3658mm) long cord with plug (NEMA 5-15P).
- Hardwired power module with 12'(3658mm) long flexible metal conduit feed, 0.5"(13mm) conduit fitting and wires for hardwire connection.
- USB Charging Port consists of one 5V USB 2.0 style A outlet. 2 Amp (shared) charging capacity.
- Attaches to 1"(25mm) to 1.5"(38mm) thick surface with use of included mounting brackets.
- Color option of black or white plastic face.

Specification Tips

- **Not for use with 2"(51mm) thick tops.**
- Configuration and quantity of power and USB ports cannot be modified in the field.
- For use with 120 volt 60 hertz power source only.
- Requires field installation.
- Requires field cut 3"(76mm) diameter access hole for power cord/conduit routing.
- Application may require approval of local authority having jurisdiction (AHJ); ensure compliance before placing orders and installation.
- Separately specified:
 - Horizontal and Vertical Wire Management

To Order, Specify:

- 1) Product number.
(No finish specification required.)

Width	Depth	Cord Length	Housing Color	Configuration	Number	Price
Corded						
7.38"(187mm)	7"(178mm)	6'(1829mm)	Black	1 Power Receptacle, 2 USB Charging, 2 Charging Pad	EUWC-PFOB-12002	\$1032.89
			White	1 Power Receptacle, 2 USB Charging, 2 Charging Pad	EUWC-PFOW-12002	1032.89
7.38"(187mm)	7"(178mm)	12'(3658mm)	Black	1 Power Receptacle, 2 USB Charging, 2 Charging Pad	EUWC-PLOB-12002	1114.25
			White	1 Power Receptacle, 2 USB Charging, 2 Charging Pad	EUWC-PLOW-12002	1114.25
Hardwire						
7.38"(187mm)	7"(178mm)	12'(3658mm)	Black	1 Power Receptacle, 2 USB Charging, 2 Charging Pad	EUWC-HLOB-12002	\$ 1216.23
			White	1 Power Receptacle, 2 USB Charging, 2 Charging Pad	EUWC-HLOW-12002	1216.23

Worksurface Power Modules — Enhanced Power Seamless

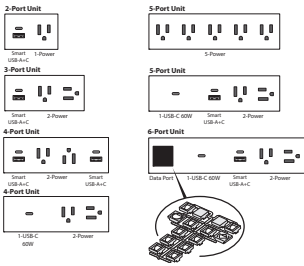
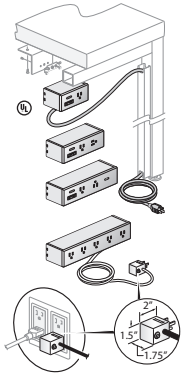

EUS1-PF0B

EUS1-HLOB
EUS1-HLOW

Class YA – GSA: Open Market

Features

- Includes power module with 2, 3, 4, 5 or 6 ports configured with simplex outlets (NEMA-5-15R), USB charging port (Smart USB-A+C) or data ports and mounting hardware.
- Power Modules specified with a data port includes a variety of data port adapters and blank covers, which accommodate most varieties of field supplied data/AV Jacks.
- The Smart USB-A+C allows for the 20W to be transferred between the 2 ports. If the USB-A is being used, the full wattage is sent to the USB-A, and the same for the USB-C. If both are being used, the wattage is distributed to each port and the port drawing the most power will receive more watts than the one that is not.
- Corded power module with 15 amp - 6'(1829mm) or 12'(3658mm) long cord with plug (NEMA 5-15P).
- Hardwire power module with 12'(3658mm) flexible galvanized metal conduit with fitting for 0.5"(13mm) knockout and wires for hardwire connection.
- USB-C 60W charging ports not available for hardwire.
- Smart USB-A+C can provide fast charge for a mobile phone and tablets. Occupies one charging port.
- USB-C 60W can charge a computer. Occupies two charging ports.
- Attaches to surface with separately specified mounting brackets.
- Enhanced Power Module Bracket EUDB-0000-B_ for perimeter edge power.
- Color option of black or white plastic front.

Specification Tips

- Configuration and quantity of power and data ports cannot be modified in the field.
- For use with 120 volt 60 hertz power source only.
- Requires field installation.
- Specify AV cables separately.
- Application may require approval of local authority having jurisdiction (AHJ); ensure compliance before placing orders and installation.
- Separately specified:
 - Mounting Bracket
 - Horizontal and Vertical Wire Management

To Order, Specify:

- 1) Product number.
(No finish specification required.)

Worksurface Power Modules — Enhanced Power Seamless

Depth	Width	Cord Length	Trim Color	Color	Port	Configuration	Number	Price
Corded								
1.875"(48mm)	4"(102mm)	6'(1829mm)	Black	Black	2	1 Power Receptacles, 1 Data Port	EUS1-PFOB-1010	\$ 504.34
						1 Power Receptacles, 1 Smart USB-A+C Charging	EUS1-PFOB-1100	603.24
						2 Power Receptacles	EUS1-PFOB-2000	504.34
5.5"(140mm)					3	1 Power Receptacles, 1 USB-C 60W Charging	EUS1-PFOB-100001	\$ 863.53
						2 Power Receptacles, 1 Data Port	EUS1-PFOB-2010	590.05
						2 Power Receptacles, 1 Smart USB-A+C Charging	EUS1-PFOB-2100	688.95
7"(178mm)					4	3 Power Receptacles	EUS1-PFOB-3000	590.05
						2 Power Receptacles, 2 Smart USB-A+C Charging	EUS1-PFOB-210010	\$ 787.85
						2 Power Receptacles, 1 USB-C 60W Charging	EUS1-PFOB-200001	863.53
9.5"(241mm)					5	2 Power Receptacles, 1 Data Port, 1 Smart USB-A+C Charging	EUS1-PFOB-201010	688.95
						2 Power Receptacles, 1 Smart USB-A+C Charging, 1 USB-C 60W Charging	EUS1-PFOB-210001	\$1048.13
						3 Power Receptacles, 1 Smart USB-A+C Charging, 1 Data Port	EUS1-PFOB-3110	774.65
11"(279mm)					6	3 Power Receptacles, 2 Smart USB-A+C Charging	EUS1-PFOB-3200	873.55
						4 Power Receptacles, 1 Data Port	EUS1-PFOB-4010	675.75
						5 Power Receptacles	EUS1-PFOB-5000	675.75
1.875"(48mm)	4"(102mm)	6'(1829mm)	White	White	2	2 Power Receptacles, 1 Smart USB-A+C Charging, 1 Data Port, 1 USB-C 60W Charging	EUS1-PFOB-211001	\$ 1133.83
						1 Power Receptacles, 1 Data Port	EUS1-PFOW-1010	\$ 332.93
						1 Power Receptacles, 1 Smart USB-A+C Charging	EUS1-PFOW-1100	431.83
5.5"(140mm)					3	2 Power Receptacles	EUS1-PFOW-2000	332.93
						1 Power Receptacles, 1 USB-C 60W Charging	EUS1-PFOW-100001	\$ 692.12
						2 Power Receptacles, 1 Data Port	EUS1-PFOW-2010	418.64
7"(178mm)					4	2 Power Receptacles, 1 Smart USB-A+C Charging	EUS1-PFOW-2100	517.54
						2 Power Receptacles, 1 USB-C 60W Charging	EUS1-PFOW-210010	\$ 616.44
						2 Power Receptacles, 1 Data Port, 1 Smart USB-A+C Charging	EUS1-PFOW-200001	692.12
9.5"(241mm)					5	3 Power Receptacles	EUS1-PFOW-3000	418.64
						2 Power Receptacles, 1 Smart USB-A+C Charging, 1 USB-C 60W Charging	EUS1-PFOW-210001	\$ 876.72
						3 Power Receptacles, 1 Smart USB-A+C Charging, 1 Data Port	EUS1-PFOW-3110	603.24
11"(279mm)					6	3 Power Receptacles, 2 Smart USB-A+C Charging	EUS1-PFOW-3200	702.14
						4 Power Receptacles, 1 Data Port	EUS1-PFOW-4010	504.34
						5 Power Receptacles	EUS1-PFOW-5000	504.34
1.875"(48mm)	4"(102mm)	12'(3658mm)	Black	Black	2	2 Power Receptacles, 1 Smart USB-A+C Charging, 1 Data Port, 1 USB-C 60W Charging	EUS1-PFOW-211001	\$ 962.42
						1 Power Receptacles, 1 Data Port	EUS1-PL0B-1010	\$ 584.91
						1 Power Receptacles, 1 Smart USB-A+C Charging	EUS1-PL0B-1100	683.81
5.5"(140mm)					3	2 Power Receptacles	EUS1-PL0B-2000	584.91
						1 Power Receptacles, 1 USB-C 60W Charging	EUS1-PL0B-100001	\$ 944.10
						2 Power Receptacles, 1 Data Port	EUS1-PL0B-2010	670.62
7"(178mm)					4	2 Power Receptacles, 1 Smart USB-A+C Charging	EUS1-PL0B-2100	769.52
						2 Power Receptacles, 1 USB-C 60W Charging	EUS1-PL0B-210010	\$ 868.42
						2 Power Receptacles, 1 Data Port, 1 Smart USB-A+C Charging	EUS1-PL0B-200001	944.10
9.5"(241mm)					5	3 Power Receptacles	EUS1-PL0B-3000	670.62
						2 Power Receptacles, 1 Smart USB-A+C Charging, 1 USB-C 60W Charging	EUS1-PL0B-210001	\$ 1128.70
						3 Power Receptacles, 1 Smart USB-A+C Charging, 1 Data Port	EUS1-PL0B-3110	855.22
11"(279mm)					6	3 Power Receptacles, 2 Smart USB-A+C Charging	EUS1-PL0B-3200	954.12
						4 Power Receptacles, 1 Data Port	EUS1-PL0B-4010	756.32
						5 Power Receptacles	EUS1-PL0B-5000	756.32
1.875"(48mm)	4"(102mm)	12'(3658mm)	Black	Black	2	2 Power Receptacles, 1 Smart USB-A+C Charging, 1 Data Port, 1 USB-C 60W Charging	EUS1-PL0B-211001	\$ 1214.40
						1 Power Receptacles, 1 Data Port	EUS1-PL0B-1010	\$ 584.91
						1 Power Receptacles, 1 Smart USB-A+C Charging	EUS1-PL0B-1100	683.81
5.5"(140mm)					3	2 Power Receptacles	EUS1-PL0B-2000	584.91
						1 Power Receptacles, 1 USB-C 60W Charging	EUS1-PL0B-100001	\$ 944.10
						2 Power Receptacles, 1 Data Port	EUS1-PL0B-2010	670.62
7"(178mm)					4	2 Power Receptacles, 1 Smart USB-A+C Charging	EUS1-PL0B-2100	769.52
						2 Power Receptacles, 1 USB-C 60W Charging	EUS1-PL0B-210010	\$ 868.42
						2 Power Receptacles, 1 Data Port, 1 Smart USB-A+C Charging	EUS1-PL0B-200001	944.10
9.5"(241mm)					5	3 Power Receptacles	EUS1-PL0B-3000	670.62
						2 Power Receptacles, 1 Smart USB-A+C Charging, 1 USB-C 60W Charging	EUS1-PL0B-210001	\$ 1128.70
						3 Power Receptacles, 1 Smart USB-A+C Charging, 1 Data Port	EUS1-PL0B-3110	855.22
11"(279mm)					6	3 Power Receptacles, 2 Smart USB-A+C Charging	EUS1-PL0B-3200	954.12
						4 Power Receptacles, 1 Data Port	EUS1-PL0B-4010	756.32
						5 Power Receptacles	EUS1-PL0B-5000	756.32
1.875"(48mm)	4"(102mm)	12'(3658mm)	Black	Black	2	2 Power Receptacles, 1 Smart USB-A+C Charging, 1 Data Port, 1 USB-C 60W Charging	EUS1-PL0B-211001	\$ 1214.40
						1 Power Receptacles, 1 Data Port	EUS1-PL0B-1010	\$ 584.91
						1 Power Receptacles, 1 Smart USB-A+C Charging	EUS1-PL0B-1100	683.81
5.5"(140mm)					3	2 Power Receptacles	EUS1-PL0B-2000	584.91
						1 Power Receptacles, 1 USB-C 60W Charging	EUS1-PL0B-100001	\$ 944.10
						2 Power Receptacles, 1 Data Port	EUS1-PL0B-2010	670.62
7"(178mm)					4	2 Power Receptacles, 1 Smart USB-A+C Charging	EUS1-PL0B-2100	769.52
						2 Power Receptacles, 1 USB-C 60W Charging	EUS1-PL0B-210010	\$ 868.42
						2 Power Receptacles, 1 Data Port, 1 Smart USB-A+C Charging	EUS1-PL0B-200001	944.10
9.5"(241mm)					5	3 Power Receptacles	EUS1-PL0B-3000	670.62
						2 Power Receptacles, 1 Smart USB-A+C Charging, 1 USB-C 60W Charging	EUS1-PL0B-210001	\$ 1128.70
						3 Power Receptacles, 1 Smart USB-A+C Charging, 1 Data Port	EUS1-PL0B-3110	855.22
11"(279mm)					6	3 Power Receptacles, 2 Smart USB-A+C Charging	EUS1-PL0B-3200	954.12
						4 Power Receptacles, 1 Data Port	EUS1-PL0B-4010	756.32
						5 Power Receptacles	EUS1-PL0B-5000	756.32

Worksurface Power Modules — Enhanced Power Seamless

Depth	Width	Cord Length	Trim Color	Color	Port	Configuration	Number	Price					
Corded													
1.875"(48mm)	4"(102mm)	12'(3658mm)	White	White	2	1 Power Receptacles, 1 Data Port	EUS1-PLOW-1010	\$ 413.50					
						1 Power Receptacles, 1 Smart USB-A+C Charging	EUS1-PLOW-1100	512.40					
						2 Power Receptacles	EUS1-PLOW-2000	413.50					
5.5"(140mm)					3	1 Power Receptacles, 1 USB-C 60W Charging	EUS1-PLOW-100001	\$ 772.69					
						2 Power Receptacles, 1 Data Port	EUS1-PLOW-2010	499.21					
						2 Power Receptacles, 1 Smart USB-A+C Charging	EUS1-PLOW-2100	598.11					
7"(178mm)					4	3 Power Receptacles	EUS1-PLOW-3000	499.21					
						2 Power Receptacles, 2 Smart USB-A+C Charging	EUS1-PLOW-210010	\$ 697.01					
						2 Power Receptacles, 1 USB-C 60W Charging	EUS1-PLOW-200001	772.69					
9.5"(241mm)					5	2 Power Receptacles, 1 Data Port, 1 Smart USB-A+C Charging	EUS1-PLOW-201010	598.11					
						2 Power Receptacles, 1 Smart USB-A+C Charging, 1 USB-C 60W Charging	EUS1-PLOW-210001	\$ 957.29					
						3 Power Receptacles, 1 Smart USB-A+C Charging, 1 Data Port	EUS1-PLOW-3110	683.81					
11"(279mm)					6	3 Power Receptacles, 2 USB-A+C Charging	EUS1-PLOW-3200	782.71					
						4 Power Receptacles, 1 Data Port	EUS1-PLOW-4010	584.91					
						5 Power Receptacles	EUS1-PLOW-5000	584.91					
11"(279mm)					6	2 Power Receptacles, 1 Smart USB-A+C Charging, 1 Data Port, 1 USB-C 60W Charging	EUS1-PLOW-211001	\$1042.99					
						Hardwire							
						1.875"(48mm)	4"(102mm)	12'(3658mm)	Black	Black	2	1 Power Receptacles, 1 Data Port	EUS1-HLOB-1010
1 Power Receptacles, 1 Smart USB-A+C Charging	EUS1-HLOB-1100	784.81											
2 Power Receptacles	EUS1-HLOB-2000	685.91											
5.5"(140mm)					3	2 Power Receptacles, 1 Data Port	EUS1-HLOB-2010	\$ 771.62					
						2 Power Receptacles, 1 Smart USB-A+C Charging	EUS1-HLOB-2100	870.52					
						3 Power Receptacles	EUS1-HLOB-3000	771.62					
7"(178mm)					4	2 Power Receptacles, 1 Smart USB-A+C Charging, 1 Data Port	EUS1-HLOB-2110	\$ 870.52					
						2 Power Receptacles, 2 Smart USB-A+C Charging	EUS1-HLOB-2200	969.42					
						3 Power Receptacles, 1 Smart USB-A+C Charging, 1 Data Port	EUS1-HLOB-3110	\$ 956.22					
9.5"(241mm)					5	3 Power Receptacles, 2 Smart USB-A+C Charging	EUS1-HLOB-3200	1055.12					
						4 Power Receptacles, 1 Data Port	EUS1-HLOB-4010	857.32					
						5 Power Receptacles	EUS1-HLOB-5000	857.32					
1.875"(48mm)	4"(102mm)	12'(3658mm)	White	White	2	1 Power Receptacles, 1 Data Port	EUS1-HLOW-1010	\$ 514.50					
						1 Power Receptacles, 1 Smart USB-A+C Charging	EUS1-HLOW-1100	613.40					
						2 Power Receptacles	EUS1-HLOW-2000	514.50					
5.5"(140mm)					3	2 Power Receptacles, 1 Data Port	EUS1-HLOW-2010	\$ 600.21					
						2 Power Receptacles, 1 Smart USB-A+C Charging	EUS1-HLOW-2100	699.11					
						3 Power Receptacles	EUS1-HLOW-3000	600.21					
7"(178mm)					4	2 Power Receptacles, 1 Smart USB-A+C Charging, 1 Data Port	EUS1-HLOW-2110	\$ 699.11					
						2 Power Receptacles, 2 Smart USB-A+C Charging	EUS1-HLOW-2200	798.01					
						3 Power Receptacles, 1 Smart USB-A+C Charging, 1 Data Port	EUS1-HLOW-3110	\$ 784.81					
9.5"(241mm)					5	3 Power Receptacles, 2 Smart USB-A+C Charging	EUS1-HLOW-3200	883.71					
						4 Power Receptacles, 1 Data Port	EUS1-HLOW-4010	685.91					
						5 Power Receptacles	EUS1-HLOW-5000	685.91					

Worksurface Power Modules — Enhanced Power

Corded

3-Port:

- (2) Power
- (1) Smart USB-A+C



EUDI-PF0B-2100

4-Port:

- (2) Power
- (1) Smart USB-A+C
- (1) Data



EUDI-PF0B-2110

6-Port:

- (2) Power
- (1) Smart USB-A+C
- (1) Data
- (1) Cable Bay

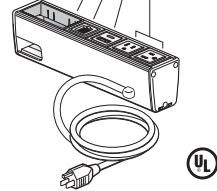

EUDI-PF0B-2112

4-Port:

- (4) Power

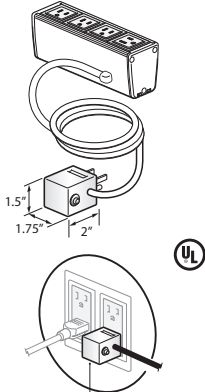

NOTE:
Always Circuit Breaker Plug
when more than 3
power outlets specified.

EUDI-PF0B-4000

Class YA

Features

- Includes power module with 3, 4 or 6 ports that can be configured with simplex outlets (NEMA-5-15R), USB charging port (Smart USB-A+C), data ports or cable bay(s) that can accept up to two pull out data/AV cables and mounting hardware.
- Data port accommodate most varieties of field supplied data/ AV jacks.
- Attaches to surface with use of separately specified mounting brackets.
- Corded power module available with 15 amp - 6'(1829mm) or 12'(3658mm) long cord with plug (NEMA 5-15P).
- The Smart USB-A+C allows for the 20W to be transferred between the 2 ports. If the USB-A is being used, the full wattage is sent to the USB-A, and the same for the USB-C. If both are being used, the wattage is distributed to each port and the port drawing the most power will receive more watts than the one that is not.
- Color option of black anodized housing with black receptacles or clear anodized housing with white receptacles.

Specification Tips

- **Configuration and quantity of power and data ports cannot be modified in the field.**
- **For use with 120 volt 60 hertz power source only.**
- Separately specify attachment hardware for desired application.
- Requires field installation.
- Specify AV cables separately.
- Cable Bay requires cables less than 0.3"(8mm) diameter.
- Application may require approval of local authority having jurisdiction (AHJ); ensure compliance before placing orders and installation.

To Order, Specify:

- 1) Product number.
(No finish specification required.)

Worksurface Power Modules — Enhanced Power Corded

Top Depth	Top Width	Cord Length	Housing Color	Port Color	Port	Configuration	Number	Price						
3"(76mm)	5"(127mm)	6'(1829mm)	Black Anodized	Black	3	1 Power Receptacle, 1 Cable Bay	EUDI-PFOB-1002	\$ 579.99						
						1 Power Receptacle, 2 Data Ports	EUDI-PFOB-1020	579.99						
						1 Power Receptacle, 1 Data Port, 1 Smart USB-A+C Charging	EUDI-PFOB-1110	678.89						
						1 Power Receptacle, 2 Smart USB-A+C Charging	EUDI-PFOB-1200	777.79						
						2 Power Receptacles, 1 Data Port	EUDI-PFOB-2010	579.99						
						2 Power Receptacles, 1 Smart USB-A+C Charging	EUDI-PFOB-2100	678.89						
						3 Power Receptacles	EUDI-PFOB-3000	579.99						
3"(76mm)	6.5"(165mm)				4	1 Power Receptacle, 1 Data Port, 1 Cable Bay	EUDI-PFOB-1012	\$ 579.99						
						1 Power Receptacle, 3 Data Ports	EUDI-PFOB-1030	579.99						
						1 Power Receptacle, 1 Smart USB-A+C Charging, 1 Cable Bay	EUDI-PFOB-1102	678.89						
						1 Power Receptacle, 3 Smart USB-A+C Charging	EUDI-PFOB-1300	876.69						
						2 Power Receptacles, 1 Cable Bay	EUDI-PFOB-2002	579.99						
						2 Power Receptacles, 2 Data Ports	EUDI-PFOB-2020	579.99						
						2 Power Receptacles, 1 Smart USB-A+C Charging, 1 Data Port	EUDI-PFOB-2110	678.89						
						2 Power Receptacles, 2 Smart USB-A+C Charging	EUDI-PFOB-2200	777.79						
						3 Power Receptacles, 1 Data Port	EUDI-PFOB-3010	579.99						
						3 Power Receptacles, 1 Smart USB-A+C Charging	EUDI-PFOB-3100	678.89						
						4 Power Receptacles	EUDI-PFOB-4000	579.99						
						3"(76mm)	9.5"(241mm)				6	1 Power Receptacle, 1 Smart USB-A+C Charging, 2 Cable Bays	EUDI-PFOB-1104	\$ 764.59
												1 Power Receptacle, 1 Smart USB-A+C Charging, 2 Data Ports, 1 Cable Bay	EUDI-PFOB-1122	764.59
1 Power Receptacle, 1 Smart USB-A+C Charging, 4 Data Ports	EUDI-PFOB-1140	764.59												
1 Power Receptacle, 2 Smart USB-A+C Charging, 1 Data Port, 1 Cable Bay	EUDI-PFOB-1212	863.49												
1 Power Receptacle, 2 Smart USB-A+C Charging, 3 Data Ports	EUDI-PFOB-1230	863.49												
1 Power Receptacle, 3 Smart USB-A+C Charging, 1 Cable Bay	EUDI-PFOB-1302	962.39												
1 Power Receptacle, 3 Smart USB-A+C Charging, 2 Data Ports	EUDI-PFOB-1320	962.39												
1 Power Receptacle, 4 Smart USB-A+C Charging, 1 Data Port	EUDI-PFOB-1410	1061.29												
2 Power Receptacles, 2 Cable Bays	EUDI-PFOB-2004	665.69												
2 Power Receptacles, 2 Data Ports, 1 Cable Bay	EUDI-PFOB-2022	665.69												
2 Power Receptacles, 4 Data Ports	EUDI-PFOB-2040	665.69												
2 Power Receptacles, 1 Smart USB-A+C Charging, 1 Data Port, 1 Cable Bay	EUDI-PFOB-2112	764.59												
2 Power Receptacles, 1 Smart USB-A+C Charging, 3 Data Ports	EUDI-PFOB-2130	764.59												
2 Power Receptacles, 2 Smart USB-A+C Charging, 1 Cable Bay	EUDI-PFOB-2202	863.49												
2 Power Receptacles, 2 Smart USB-A+C Charging, 2 Data Ports	EUDI-PFOB-2220	863.49												
2 Power Receptacles, 3 Smart USB-A+C Charging, 1 Data Port	EUDI-PFOB-2310	962.39												
2 Power Receptacles, 4 Smart USB-A+C Charging	EUDI-PFOB-2400	1061.29												
3 Power Receptacles, 3 Data Ports	EUDI-PFOB-3030	665.69												
3 Power Receptacles, 1 Smart USB-A+C Charging, 1 Cable Bay	EUDI-PFOB-3102	764.59												
3 Power Receptacles, 1 Smart USB-A+C Charging, 2 Data Ports	EUDI-PFOB-3120	764.59												
3 Power Receptacles, 2 Smart USB-A+C Charging, 1 Data Port	EUDI-PFOB-3210	863.49												
3 Power Receptacles, 3 Smart USB-A+C Charging	EUDI-PFOB-3300	962.39												
4 Power Receptacles, 1 Cable Bay	EUDI-PFOB-4002	665.69												
4 Power Receptacles, 2 Data Ports	EUDI-PFOB-4020	665.69												
4 Power Receptacles, 1 Smart USB-A+C Charging, 1 Data Port	EUDI-PFOB-4110	764.59												
4 Power Receptacles, 2 Smart USB-A+C Charging	EUDI-PFOB-4200	863.49												
5 Power Receptacles, 1 Data Port	EUDI-PFOB-5010	665.69												
5 Power Receptacles, 1 Smart USB-A+C Charging	EUDI-PFOB-5100	764.59												
6 Power Receptacles	EUDI-PFOB-6000	665.69												

Worksurface Power Modules — Enhanced Power Corded

Top Depth	Top Width	Cord Length	Housing Color	Port Color	Port	Configuration	Number	Price	
3"(76mm)	9.5"(241mm)	6'(1829mm)	Clear Anodized	White	3	1 Power Receptacle, 1 Cable Bay	EUDI-PFOW-1002	\$408.58	
						1 Power Receptacle, 2 Data Ports	EUDI-PFOW-1020	408.58	
						1 Power Receptacle, 1 Data Port, 1 Smart USB-A+C Charging	EUDI-PFOW-1100	507.48	
						1 Power Receptacle, 2 Smart USB-A+C Charging	EUDI-PFOW-1200	606.38	
						2 Power Receptacles, 1 Data Port	EUDI-PFOW-2010	408.58	
						2 Power Receptacles, 1 Smart USB-A+C Charging	EUDI-PFOW-2100	507.48	
					4	3 Power Receptacles	EUDI-PFOW-3000	408.58	
						1 Power Receptacle, 1 Data Port, 1 Cable Bay	EUDI-PFOW-1012	\$408.58	
						1 Power Receptacle, 3 Data Ports	EUDI-PFOW-1030	408.58	
						1 Power Receptacle, 1 Smart USB-A+C Charging, 1 Cable Bay	EUDI-PFOW-1102	507.48	
						1 Power Receptacle, 3 Smart USB-A+C Charging	EUDI-PFOW-1300	705.28	
						2 Power Receptacles, 1 Cable Bay	EUDI-PFOW-2002	408.58	
						2 Power Receptacles, 2 Data Ports	EUDI-PFOW-2020	408.58	
						2 Power Receptacles, 1 Smart USB-A+C Charging, 1 Data Port	EUDI-PFOW-2110	507.48	
						2 Power Receptacles, 2 Smart USB-A+C Charging	EUDI-PFOW-2200	606.38	
						3 Power Receptacles, 1 Data Port	EUDI-PFOW-3010	408.58	
						3 Power Receptacles, 1 Smart USB-A+C Charging	EUDI-PFOW-3100	507.48	
						4 Power Receptacles	EUDI-PFOW-4000	408.58	
						6	1 Power Receptacle, 1 Smart USB-A+C Charging, 2 Cable Bays	EUDI-PFOW-1104	\$593.18
							1 Power Receptacle, 1 Smart USB-A+C Charging, 2 Data Ports, 1 Cable Bay	EUDI-PFOW-1122	593.18
					1 Power Receptacle, 1 Smart USB-A+C Charging, 4 Data Ports		EUDI-PFOW-1140	593.18	
					1 Power Receptacle, 2 Smart USB-A+C Charging, 1 Data Port, 1 Cable Bay		EUDI-PFOW-1212	692.08	
					1 Power Receptacle, 2 Smart USB-A+C Charging, 3 Data Ports		EUDI-PFOW-1230	692.08	
					1 Power Receptacle, 3 Smart USB-A+C Charging, 1 Cable Bay		EUDI-PFOW-1302	790.98	
					1 Power Receptacle, 3 Smart USB-A+C Charging, 2 Data Ports		EUDI-PFOW-1320	790.98	
					1 Power Receptacle, 4 Smart USB-A+C Charging, 1 Data Port		EUDI-PFOW-1410	889.88	
					2 Power Receptacles, 2 Cable Bays		EUDI-PFOW-2004	494.28	
					2 Power Receptacles, 2 Data Ports, 1 Cable Bay		EUDI-PFOW-2022	494.28	
					2 Power Receptacles, 4 Data Ports		EUDI-PFOW-2040	494.28	
					2 Power Receptacles, 1 Smart USB-A+C Charging, 1 Data Port, 1 Cable Bay		EUDI-PFOW-2112	593.18	
2 Power Receptacles, 1 Smart USB-A+C Charging, 3 Data Ports	EUDI-PFOW-2130	593.18							
2 Power Receptacles, 2 Smart USB-A+C Charging, 1 Cable Bay	EUDI-PFOW-2202	692.08							
2 Power Receptacles, 2 Smart USB-A+C Charging, 2 Data Ports	EUDI-PFOW-2220	692.08							
2 Power Receptacles, 3 Smart USB-A+C Charging, 1 Data Port	EUDI-PFOW-2310	790.98							
2 Power Receptacles, 4 Smart USB-A+C Charging	EUDI-PFOW-2400	889.88							
3 Power Receptacles, 3 Data Ports	EUDI-PFOW-3030	494.28							
3 Power Receptacles, 1 Smart USB-A+C Charging, 1 Cable Bay	EUDI-PFOW-3102	593.18							
3 Power Receptacles, 1 Smart USB-A+C Charging, 2 Data Ports	EUDI-PFOW-3120	593.18							
3 Power Receptacles, 2 Smart USB-A+C Charging, 1 Data Port	EUDI-PFOW-3210	692.08							
3 Power Receptacles, 3 Smart USB-A+C Charging	EUDI-PFOW-3300	790.98							
4 Power Receptacles, 1 Cable Bay	EUDI-PFOW-4002	494.28							
4 Power Receptacles, 2 Data Ports	EUDI-PFOW-4020	494.28							
4 Power Receptacles, 1 Smart USB-A+C Charging, 1 Data Port	EUDI-PFOW-4110	593.18							
4 Power Receptacles, 2 Smart USB-A+C Charging	EUDI-PFOW-4200	692.08							
5 Power Receptacles, 1 Data Port	EUDI-PFOW-5010	494.28							
5 Power Receptacles, 1 Smart USB-A+C Charging	EUDI-PFOW-5100	593.18							
6 Power Receptacles	EUDI-PFOW-6000	494.28							

Worksurface Power Modules — Enhanced Power Corded

Top Depth	Top Width	Cord Length	Housing Color	Port Color	Port	Configuration	Number	Price	
3"(76mm)	9.5"(241mm)	12'(3658mm)	Black Anodized	Black	3	1 Power Receptacle, 1 Cable Bay	EUDI-PLOB-1002	\$ 660.56	
						1 Power Receptacle, 2 Data Ports	EUDI-PLOB-1020	660.56	
						1 Power Receptacle, 1 Data Port, 1 Smart USB-A+C Charging	EUDI-PLOB-1110	759.46	
						1 Power Receptacle, 2 Smart USB-A+C Charging	EUDI-PLOB-1200	858.36	
						2 Power Receptacles, 1 Data Port	EUDI-PLOB-2010	660.56	
						2 Power Receptacles, 1 Smart USB-A+C Charging	EUDI-PLOB-2100	759.46	
						3 Power Receptacles	EUDI-PLOB-3000	660.56	
						4	1 Power Receptacle, 1 Data Port, 1 Cable Bay	EUDI-PLOB-1012	\$ 660.56
							1 Power Receptacle, 3 Data Ports	EUDI-PLOB-1030	660.56
					1 Power Receptacle, 1 Smart USB-A+C Charging, 1 Cable Bay		EUDI-PLOB-1102	759.46	
					1 Power Receptacle, 3 Smart USB-A+C Charging		EUDI-PLOB-1300	957.26	
					2 Power Receptacles, 1 Cable Bay		EUDI-PLOB-2002	660.56	
					2 Power Receptacles, 2 Data Ports		EUDI-PLOB-2020	660.56	
					2 Power Receptacles, 1 Smart USB-A+C Charging, 1 Data Port		EUDI-PLOB-2110	759.46	
					2 Power Receptacles, 2 Smart USB-A+C Charging		EUDI-PLOB-2200	858.36	
					3 Power Receptacles, 1 Data Port		EUDI-PLOB-3010	660.56	
					3 Power Receptacles, 1 Smart USB-A+C Charging		EUDI-PLOB-3100	759.46	
					4 Power Receptacles		EUDI-PLOB-4000	660.56	
					6		1 Power Receptacle, 1 Smart USB-A+C Charging, 2 Cable Bays	EUDI-PLOB-1104	\$ 845.16
							1 Power Receptacle, 1 Smart USB-A+C Charging, 2 Data Ports, 1 Cable Bay	EUDI-PLOB-1122	845.16
							1 Power Receptacle, 1 Smart USB-A+C Charging, 4 Data Ports	EUDI-PLOB-1140	845.16
							1 Power Receptacle, 2 Smart USB-A+C Charging, 1 Data Port, 1 Cable Bay	EUDI-PLOB-1212	944.06
						1 Power Receptacle, 2 Smart USB-A+C Charging, 3 Data Ports	EUDI-PLOB-1230	944.06	
						1 Power Receptacle, 3 Smart USB-A+C Charging, 1 Cable Bay	EUDI-PLOB-1302	1042.96	
						1 Power Receptacle, 3 Smart USB-A+C Charging, 2 Data Ports	EUDI-PLOB-1320	1042.96	
						1 Power Receptacle, 4 Smart USB-A+C Charging, 1 Data Port	EUDI-PLOB-1410	1141.86	
						2 Power Receptacles, 2 Cable Bays	EUDI-PLOB-2004	746.26	
						2 Power Receptacles, 2 Data Ports, 1 Cable Bay	EUDI-PLOB-2022	746.26	
						2 Power Receptacles, 4 Data Ports	EUDI-PLOB-2040	746.26	
						2 Power Receptacles, 1 Smart USB-A+C Charging, 1 Data Port, 1 Cable Bay	EUDI-PLOB-2112	845.16	
						2 Power Receptacles, 1 Smart USB-A+C Charging, 3 Data Ports	EUDI-PLOB-2130	845.16	
						2 Power Receptacles, 2 Smart USB-A+C Charging, 1 Cable Bay	EUDI-PLOB-2202	944.06	
						2 Power Receptacles, 2 Smart USB-A+C Charging, 2 Data Ports	EUDI-PLOB-2220	944.06	
2 Power Receptacles, 3 Smart USB-A+C Charging, 1 Data Port	EUDI-PLOB-2310	1042.96							
2 Power Receptacles, 4 Smart USB-A+C Charging	EUDI-PLOB-2400	1141.86							
3 Power Receptacles, 3 Data Ports	EUDI-PLOB-3030	746.26							
3 Power Receptacles, 1 Smart USB-A+C Charging, 1 Cable Bay	EUDI-PLOB-3102	845.16							
3 Power Receptacles, 1 Smart USB-A+C Charging, 2 Data Ports	EUDI-PLOB-3120	845.16							
3 Power Receptacles, 2 Smart USB-A+C Charging, 1 Data Port	EUDI-PLOB-3210	944.06							
3 Power Receptacles, 3 Smart USB-A+C Charging	EUDI-PLOB-3300	1042.96							
4 Power Receptacles, 1 Cable Bay	EUDI-PLOB-4002	746.26							
4 Power Receptacles, 2 Data Ports	EUDI-PLOB-4020	746.26							
4 Power Receptacles, 1 Smart USB-A+C Charging, 1 Data Port	EUDI-PLOB-4110	845.16							
4 Power Receptacles, 2 Smart USB-A+C Charging	EUDI-PLOB-4200	944.06							
5 Power Receptacles, 1 Data Port	EUDI-PLOB-5010	746.26							
5 Power Receptacles, 1 Smart USB-A+C Charging	EUDI-PLOB-5100	845.16							
6 Power Receptacles	EUDI-PLOB-6000	746.26							

Worksurface Power Modules — Enhanced Power Corded

Top Depth	Top Width	Cord Length	Housing Color	Port Color	Port	Configuration	Number	Price	
3"(76mm)	9.5"(241mm)	12'(3658mm)	Clear Anodized	White	3	1 Power Receptacle, 1 Cable Bay	EUDI-PLOW-1002	\$489.15	
						1 Power Receptacle, 2 Data Ports	EUDI-PLOW-1020	489.15	
						1 Power Receptacle, 1 Data Port, 1 Smart USB-A+C Charging	EUDI-PLOW-1110	588.05	
						1 Power Receptacle, 2 Smart USB-A+C Charging	EUDI-PLOW-1200	686.95	
						2 Power Receptacles, 1 Data Port	EUDI-PLOW-2010	489.15	
						2 Power Receptacles, 1 Smart USB-A+C Charging	EUDI-PLOW-2100	588.05	
						3 Power Receptacles	EUDI-PLOW-3000	489.15	
						4	1 Power Receptacle, 1 Data Port, 1 Cable Bay	EUDI-PLOW-1012	\$489.15
							1 Power Receptacle, 3 Data Ports	EUDI-PLOW-1030	489.15
					1 Power Receptacle, 1 Smart USB-A+C Charging, 1 Cable Bay		EUDI-PLOW-1102	588.05	
					1 Power Receptacle, 3 Smart USB-A+C Charging		EUDI-PLOW-1300	785.85	
					2 Power Receptacles, 1 Cable Bay		EUDI-PLOW-2002	489.15	
					2 Power Receptacles, 2 Data Ports		EUDI-PLOW-2020	489.15	
					2 Power Receptacles, 1 Smart USB-A+C Charging, 1 Data Port		EUDI-PLOW-2110	588.05	
					2 Power Receptacles, 2 Smart USB-A+C Charging		EUDI-PLOW-2200	686.95	
					3 Power Receptacles, 1 Data Port		EUDI-PLOW-3010	489.15	
					3 Power Receptacles, 1 Smart USB-A+C Charging		EUDI-PLOW-3100	588.05	
					4 Power Receptacles		EUDI-PLOW-4000	489.15	
					6		1 Power Receptacle, 1 Smart USB-A+C Charging, 2 Cable Bays	EUDI-PLOW-1104	\$673.75
						1 Power Receptacle, 1 Smart USB-A+C Charging, 2 Data Ports, 1 Cable Bay	EUDI-PLOW-1122	673.75	
						1 Power Receptacle, 1 Smart USB-A+C Charging, 4 Data Ports	EUDI-PLOW-1140	673.75	
						1 Power Receptacle, 2 Smart USB-A+C Charging, 1 Data Port, 1 Cable Bay	EUDI-PLOW-1212	772.65	
						1 Power Receptacle, 2 Smart USB-A+C Charging, 3 Data Ports	EUDI-PLOW-1230	772.65	
						1 Power Receptacle, 3 Smart USB-A+C Charging, 1 Cable Bay	EUDI-PLOW-1302	871.55	
						1 Power Receptacle, 3 Smart USB-A+C Charging, 2 Data Ports	EUDI-PLOW-1320	871.55	
						1 Power Receptacle, 4 Smart USB-A+C Charging, 1 Data Port	EUDI-PLOW-1410	970.45	
						2 Power Receptacles, 2 Cable Bays	EUDI-PLOW-2004	574.85	
						2 Power Receptacles, 2 Data Ports, 1 Cable Bay	EUDI-PLOW-2022	574.85	
						2 Power Receptacles, 4 Data Ports	EUDI-PLOW-2040	574.85	
						2 Power Receptacles, 1 Smart USB-A+C Charging, 1 Data Port, 1 Cable Bay	EUDI-PLOW-2112	673.75	
2 Power Receptacles, 1 Smart USB-A+C Charging, 3 Data Ports	EUDI-PLOW-2130	673.75							
2 Power Receptacles, 2 Smart USB-A+C Charging, 1 Cable Bay	EUDI-PLOW-2202	772.65							
2 Power Receptacles, 2 Smart USB-A+C Charging, 2 Data Ports	EUDI-PLOW-2220	772.65							
2 Power Receptacles, 3 Smart USB-A+C Charging, 1 Data Port	EUDI-PLOW-2310	871.55							
2 Power Receptacles, 4 Smart USB-A+C Charging	EUDI-PLOW-2400	970.45							
3 Power Receptacles, 3 Data Ports	EUDI-PLOW-3030	574.85							
3 Power Receptacles, 1 Smart USB-A+C Charging, 1 Cable Bay	EUDI-PLOW-3102	673.75							
3 Power Receptacles, 1 Smart USB-A+C Charging, 2 Data Ports	EUDI-PLOW-3120	673.75							
3 Power Receptacles, 2 Smart USB-A+C Charging, 1 Data Port	EUDI-PLOW-3210	772.65							
3 Power Receptacles, 3 Smart USB-A+C Charging	EUDI-PLOW-3300	871.55							
4 Power Receptacles, 1 Cable Bay	EUDI-PLOW-4002	574.85							
4 Power Receptacles, 2 Data Ports	EUDI-PLOW-4020	574.85							
4 Power Receptacles, 1 Smart USB-A+C Charging, 1 Data Port	EUDI-PLOW-4110	673.75							
4 Power Receptacles, 2 Smart USB-A+C Charging	EUDI-PLOW-4200	772.65							
5 Power Receptacles, 1 Data Port	EUDI-PLOW-5010	574.85							
5 Power Receptacles, 1 Smart USB-A+C Charging	EUDI-PLOW-5100	673.75							
6 Power Receptacles	EUDI-PLOW-6000	574.85							

Worksurface Power Modules — Enhanced Power Hardware

3-Port:

- (2) Power
- (1) Smart USB-A+C

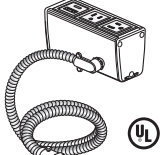

Hard Wired

EUDI-HFOB-2010

4-Port:

- (2) Power
- (1) Smart USB-A+C
- (1) Data

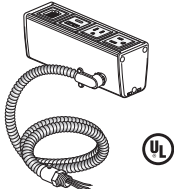

Hard Wired

EUDI-HFOB-2110

6-Port:

- (2) Power
- (1) Smart USB-A+C
- (1) Data
- (1) Cable Bay

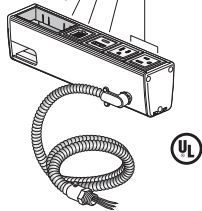

Hard Wired

EUDI-HFOB-2112

Class YA

Features

- Includes power module with 3, 4 or 6 ports that can be configured with simplex outlets (NEMA-5-15R), USB charging port (Smart USB-A+C), data ports or cable bay(s) that can accept up to two pull out data/AV cables and mounting hardware.
- Data port accommodate most varieties of field supplied data/ AV jacks.
- Attaches to surface with use of separately specified mounting brackets.
- Hardwired power module with 6'(1829mm) or 12'(3658mm) long flexible metal conduit feed, 0.5"(13mm) conduit fitting and wires for hardwire connection.
- The Smart USB-A+C allows for the 20W to be transferred between the 2 ports. If the USB-A is being used, the full wattage is sent to the USB-A, and the same for the USB-C. If both are being used, the wattage is distributed to each port and the port drawing the most power will receive more watts than the one that is not.
- Color option of black anodized housing with black receptacles or clear anodized housing with white receptacles.

Specification Tips

- **Configuration and quantity of power and data ports cannot be modified in the field.**
- **For use with 120 volt 60 hertz power source only.**
- Separately specify attachment hardware for desired application.
- Requires field installation.
- Specify AV cables separately.
- Cable Bay requires cables less than 0.3"(8mm) diameter.
- Application may require approval of local authority having jurisdiction (AHJ); ensure compliance before placing orders and installation.

To Order, Specify:

- 1) Product number.
(No finish specification required.)

Worksurface Power Modules — Enhanced Power Hardware

Top Depth	Top Width	Conduit Length	Housing Color	Port Color	Port	Configuration	Number	Price						
3"(76mm)	5"(127mm)	6"(1829mm)	Black Anodized	Black	3	1 Power Receptacle, 1 Cable Bay	EUDI-HFOB-1002	\$ 680.99						
						1 Power Receptacle, 2 Data Ports	EUDI-HFOB-1020	680.99						
						1 Power Receptacle, 1 Data Port, 1 Smart USB-A+C Charging	EUDI-HFOB-1110	779.89						
						1 Power Receptacle, 2 Smart USB-A+C Charging	EUDI-HFOB-1200	878.79						
						2 Power Receptacles, 1 Data Port	EUDI-HFOB-2010	680.99						
						2 Power Receptacles, 1 Smart USB-A+C Charging	EUDI-HFOB-2100	779.89						
						3 Power Receptacles	EUDI-HFOB-3000	680.99						
3"(76mm)	6.5"(165mm)				4	1 Power Receptacle, 1 Data Port, 1 Cable Bay	EUDI-HFOB-1012	\$ 680.99						
						1 Power Receptacle, 3 Data Ports	EUDI-HFOB-1030	680.99						
						1 Power Receptacle, 1 Smart USB-A+C Charging, 1 Cable Bay	EUDI-HFOB-1102	779.89						
						1 Power Receptacle, 3 Smart USB-A+C Charging	EUDI-HFOB-1300	977.69						
						2 Power Receptacles, 1 Cable Bay	EUDI-HFOB-2002	680.99						
						2 Power Receptacles, 2 Data Ports	EUDI-HFOB-2020	680.99						
						2 Power Receptacles, 1 Smart USB-A+C Charging, 1 Data Port	EUDI-HFOB-2110	779.89						
						2 Power Receptacles, 2 Smart USB-A+C Charging	EUDI-HFOB-2200	878.79						
						3 Power Receptacles, 1 Data Port	EUDI-HFOB-3010	680.99						
						3 Power Receptacles, 1 Smart USB-A+C Charging	EUDI-HFOB-3100	779.89						
						4 Power Receptacles	EUDI-HFOB-4000	680.99						
						3"(76mm)	9.5"(241mm)				6	1 Power Receptacle, 1 Smart USB-A+C Charging, 2 Cable Bays	EUDI-HFOB-1104	\$ 865.59
												1 Power Receptacle, 1 Smart USB-A+C Charging, 2 Data Ports, 1 Cable Bay	EUDI-HFOB-1122	865.59
1 Power Receptacle, 1 Smart USB-A+C Charging, 4 Data Ports	EUDI-HFOB-1140	865.59												
1 Power Receptacle, 2 Smart USB-A+C Charging, 1 Data Port, 1 Cable Bay	EUDI-HFOB-1212	964.49												
1 Power Receptacle, 2 Smart USB-A+C Charging, 3 Data Ports	EUDI-HFOB-1230	964.49												
1 Power Receptacle, 3 Smart USB-A+C Charging, 1 Cable Bay	EUDI-HFOB-1302	1063.39												
1 Power Receptacle, 3 Smart USB-A+C Charging, 2 Data Ports	EUDI-HFOB-1320	1063.39												
1 Power Receptacle, 4 Smart USB-A+C Charging, 1 Data Port	EUDI-HFOB-1410	1162.29												
2 Power Receptacles, 2 Cable Bays	EUDI-HFOB-2004	766.69												
2 Power Receptacles, 2 Data Ports, 1 Cable Bay	EUDI-HFOB-2022	766.69												
2 Power Receptacles, 4 Data Ports	EUDI-HFOB-2040	766.69												
2 Power Receptacles, 1 Smart USB-A+C Charging, 1 Data Port, 1 Cable Bay	EUDI-HFOB-2112	865.59												
2 Power Receptacles, 1 Smart USB-A+C Charging, 3 Data Ports	EUDI-HFOB-2130	865.59												
2 Power Receptacles, 2 Smart USB-A+C Charging, 1 Cable Bay	EUDI-HFOB-2202	964.49												
2 Power Receptacles, 2 Smart USB-A+C Charging, 2 Data Ports	EUDI-HFOB-2220	964.49												
2 Power Receptacles, 3 Smart USB-A+C Charging, 1 Data Port	EUDI-HFOB-2310	1063.39												
2 Power Receptacles, 4 Smart USB-A+C Charging	EUDI-HFOB-2400	1162.29												
3 Power Receptacles, 3 Data Ports	EUDI-HFOB-3030	766.69												
3 Power Receptacles, 1 Smart USB-A+C Charging, 1 Cable Bay	EUDI-HFOB-3102	865.59												
3 Power Receptacles, 1 Smart USB-A+C Charging, 2 Data Ports	EUDI-HFOB-3120	865.59												
3 Power Receptacles, 2 Smart USB-A+C Charging, 1 Data Port	EUDI-HFOB-3210	964.49												
3 Power Receptacles, 3 Smart USB-A+C Charging	EUDI-HFOB-3300	1063.39												
4 Power Receptacles, 1 Cable Bay	EUDI-HFOB-4002	766.69												
4 Power Receptacles, 2 Data Ports	EUDI-HFOB-4020	766.69												
4 Power Receptacles, 1 Smart USB-A+C Charging, 1 Data Port	EUDI-HFOB-4110	865.59												
4 Power Receptacles, 2 Smart USB-A+C Charging	EUDI-HFOB-4200	964.49												
5 Power Receptacles, 1 Data Port	EUDI-HFOB-5010	766.69												
5 Power Receptacles, 1 Smart USB-A+C Charging	EUDI-HFOB-5100	865.59												
6 Power Receptacles	EUDI-HFOB-6000	766.69												

Worksurface Power Modules — Enhanced Power Hardware

Top Depth	Top Width	Conduit Length	Housing Color	Port Color	Port	Configuration	Number	Price						
3"(76mm)	5"(127mm)	6"(152mm)	Clear Anodized	White	3	1 Power Receptacle, 1 Cable Bay	EUDI-HFOW-1002	\$509.58						
						1 Power Receptacle, 2 Data Ports	EUDI-HFOW-1020	509.58						
						1 Power Receptacle, 1 Data Port, 1 Smart USB-A+C Charging	EUDI-HFOW-1110	608.48						
						1 Power Receptacle, 2 Smart USB-A+C Charging	EUDI-HFOW-1200	707.38						
						2 Power Receptacles, 1 Data Port	EUDI-HFOW-2010	509.58						
						2 Power Receptacles, 1 Smart USB-A+C Charging	EUDI-HFOW-2100	608.48						
						3 Power Receptacles	EUDI-HFOW-3000	509.58						
3"(76mm)	6.5"(165mm)				4	1 Power Receptacle, 1 Data Port, 1 Cable Bay	EUDI-HFOW-1012	\$509.58						
						1 Power Receptacle, 3 Data Ports	EUDI-HFOW-1030	509.58						
						1 Power Receptacle, 1 Smart USB-A+C Charging, 1 Cable Bay	EUDI-HFOW-1102	608.48						
						1 Power Receptacle, 3 Smart USB-A+C Charging	EUDI-HFOW-1300	806.28						
						2 Power Receptacles, 1 Cable Bay	EUDI-HFOW-2002	509.58						
						2 Power Receptacles, 2 Data Ports	EUDI-HFOW-2020	509.58						
						2 Power Receptacles, 1 Smart USB-A+C Charging, 1 Data Port	EUDI-HFOW-2110	608.48						
						2 Power Receptacles, 2 Smart USB-A+C Charging	EUDI-HFOW-2200	707.38						
						3 Power Receptacles, 1 Data Port	EUDI-HFOW-3010	509.58						
						3 Power Receptacles, 1 Smart USB-A+C Charging	EUDI-HFOW-3100	608.48						
						4 Power Receptacles	EUDI-HFOW-4000	509.58						
						3"(76mm)	9.5"(241mm)				6	1 Power Receptacle, 1 Smart USB-A+C Charging, 2 Cable Bays	EUDI-HFOW-1104	\$694.18
												1 Power Receptacle, 1 Smart USB-A+C Charging, 2 Data Ports, 1 Cable Bay	EUDI-HFOW-1122	694.18
1 Power Receptacle, 1 Smart USB-A+C Charging, 4 Data Ports	EUDI-HFOW-1140	694.18												
1 Power Receptacle, 2 Smart USB-A+C Charging, 1 Data Port, 1 Cable Bay	EUDI-HFOW-1212	793.08												
1 Power Receptacle, 2 Smart USB-A+C Charging, 3 Data Ports	EUDI-HFOW-1230	793.08												
1 Power Receptacle, 3 Smart USB-A+C Charging, 1 Cable Bay	EUDI-HFOW-1302	891.98												
1 Power Receptacle, 3 Smart USB-A+C Charging, 2 Data Ports	EUDI-HFOW-1320	891.98												
1 Power Receptacle, 4 Smart USB-A+C Charging, 1 Data Port	EUDI-HFOW-1410	990.88												
2 Power Receptacles, 2 Cable Bays	EUDI-HFOW-2004	595.28												
2 Power Receptacles, 2 Data Ports, 1 Cable Bay	EUDI-HFOW-2022	595.28												
2 Power Receptacles, 4 Data Ports	EUDI-HFOW-2040	595.28												
2 Power Receptacles, 1 Smart USB-A+C Charging, 1 Data Port, 1 Cable Bay	EUDI-HFOW-2112	694.18												
2 Power Receptacles, 1 Smart USB-A+C Charging, 3 Data Ports	EUDI-HFOW-2130	694.18												
2 Power Receptacles, 2 Smart USB-A+C Charging, 1 Cable Bay	EUDI-HFOW-2202	793.08												
2 Power Receptacles, 2 Smart USB-A+C Charging, 2 Data Ports	EUDI-HFOW-2220	793.08												
2 Power Receptacles, 3 Smart USB-A+C Charging, 1 Data Port	EUDI-HFOW-2310	891.98												
2 Power Receptacles, 4 Smart USB-A+C Charging	EUDI-HFOW-2400	990.88												
3 Power Receptacles, 3 Data Ports	EUDI-HFOW-3030	595.28												
3 Power Receptacles, 1 Smart USB-A+C Charging, 1 Cable Bay	EUDI-HFOW-3102	694.18												
3 Power Receptacles, 1 Smart USB-A+C Charging, 2 Data Ports	EUDI-HFOW-3120	694.18												
3 Power Receptacles, 2 Smart USB-A+C Charging, 1 Data Port	EUDI-HFOW-3210	793.08												
3 Power Receptacles, 3 Smart USB-A+C Charging	EUDI-HFOW-3300	891.98												
4 Power Receptacles, 1 Cable Bay	EUDI-HFOW-4002	595.28												
4 Power Receptacles, 2 Data Ports	EUDI-HFOW-4020	595.28												
4 Power Receptacles, 1 Smart USB-A+C Charging, 1 Data Port	EUDI-HFOW-4110	694.18												
4 Power Receptacles, 2 Smart USB-A+C Charging	EUDI-HFOW-4200	793.08												
5 Power Receptacles, 1 Data Port	EUDI-HFOW-5010	595.28												
5 Power Receptacles, 1 Smart USB-A+C Charging	EUDI-HFOW-5100	694.18												
6 Power Receptacles	EUDI-HFOW-6000	595.28												

Worksurface Power Modules — Enhanced Power Hardware

Top Depth	Top Width	Conduit Length	Housing Color	Port Color	Port	Configuration	Number	Price						
3"(76mm)	5"(127mm)	12"(305mm)	Black Anodized	Black	3	1 Power Receptacle, 1 Cable Bay	EUDI-HLOB-1002	\$ 761.56						
						1 Power Receptacle, 2 Data Ports	EUDI-HLOB-1020	761.56						
						1 Power Receptacle, 1 Data Port, 1 Smart USB-A+C Charging	EUDI-HLOB-1110	860.46						
						1 Power Receptacle, 2 Smart USB-A+C Charging	EUDI-HLOB-1200	959.36						
						2 Power Receptacles, 1 Data Port	EUDI-HLOB-2010	761.56						
						2 Power Receptacles, 1 Smart USB-A+C Charging	EUDI-HLOB-2100	860.46						
						3 Power Receptacles	EUDI-HLOB-3000	761.56						
3"(76mm)	6.5"(165mm)				4	1 Power Receptacle, 1 Data Port, 1 Cable Bay	EUDI-HLOB-1012	\$ 761.56						
						1 Power Receptacle, 3 Data Ports	EUDI-HLOB-1030	761.56						
						1 Power Receptacle, 1 Smart USB-A+C Charging, 1 Cable Bay	EUDI-HLOB-1102	860.46						
						1 Power Receptacle, 3 Smart USB-A+C Charging	EUDI-HLOB-1300	1058.26						
						2 Power Receptacles, 1 Cable Bay	EUDI-HLOB-2002	761.56						
						2 Power Receptacles, 2 Data Ports	EUDI-HLOB-2020	761.56						
						2 Power Receptacles, 1 Smart USB-A+C Charging, 1 Data Port	EUDI-HLOB-2110	860.46						
						2 Power Receptacles, 2 Smart USB-A+C Charging	EUDI-HLOB-2200	959.36						
						3 Power Receptacles, 1 Data Port	EUDI-HLOB-3010	761.56						
						3 Power Receptacles, 1 Smart USB-A+C Charging	EUDI-HLOB-3100	860.46						
						4 Power Receptacles	EUDI-HLOB-4000	761.56						
						3"(76mm)	9.5"(241mm)				6	1 Power Receptacle, 1 Smart USB-A+C Charging, 2 Cable Bays	EUDI-HLOB-1104	\$ 946.16
												1 Power Receptacle, 1 Smart USB-A+C Charging, 2 Data Ports, 1 Cable Bay	EUDI-HLOB-1122	946.16
1 Power Receptacle, 1 Smart USB-A+C Charging, 4 Data Ports	EUDI-HLOB-1140	946.16												
1 Power Receptacle, 2 Smart USB-A+C Charging, 1 Data Port, 1 Cable Bay	EUDI-HLOB-1212	1045.06												
1 Power Receptacle, 2 Smart USB-A+C Charging, 3 Data Ports	EUDI-HLOB-1230	1045.06												
1 Power Receptacle, 3 Smart USB-A+C Charging, 1 Cable Bay	EUDI-HLOB-1302	1143.96												
1 Power Receptacle, 3 Smart USB-A+C Charging, 2 Data Ports	EUDI-HLOB-1320	1143.96												
1 Power Receptacle, 4 Smart USB-A+C Charging, 1 Data Port	EUDI-HLOB-1410	1242.86												
2 Power Receptacles, 2 Cable Bays	EUDI-HLOB-2004	847.26												
2 Power Receptacles, 2 Data Ports, 1 Cable Bay	EUDI-HLOB-2022	847.26												
2 Power Receptacles, 4 Data Ports	EUDI-HLOB-2040	847.26												
2 Power Receptacles, 1 Smart USB-A+C Charging, 1 Data Port, 1 Cable Bay	EUDI-HLOB-2112	946.16												
2 Power Receptacles, 1 Smart USB-A+C Charging, 3 Data Ports	EUDI-HLOB-2130	946.16												
2 Power Receptacles, 2 Smart USB-A+C Charging, 1 Cable Bay	EUDI-HLOB-2202	1045.06												
2 Power Receptacles, 2 Smart USB-A+C Charging, 2 Data Ports	EUDI-HLOB-2220	1045.06												
2 Power Receptacles, 3 Smart USB-A+C Charging, 1 Data Port	EUDI-HLOB-2310	1143.96												
2 Power Receptacles, 4 Smart USB-A+C Charging	EUDI-HLOB-2400	1242.86												
3 Power Receptacles, 3 Data Ports	EUDI-HLOB-3030	847.26												
3 Power Receptacles, 1 Smart USB-A+C Charging, 1 Cable Bay	EUDI-HLOB-3102	946.16												
3 Power Receptacles, 1 Smart USB-A+C Charging, 2 Data Ports	EUDI-HLOB-3120	946.16												
3 Power Receptacles, 2 Smart USB-A+C Charging, 1 Data Port	EUDI-HLOB-3210	1045.06												
3 Power Receptacles, 3 Smart USB-A+C Charging	EUDI-HLOB-3300	1143.96												
4 Power Receptacles, 1 Cable Bay	EUDI-HLOB-4002	847.26												
4 Power Receptacles, 2 Data Ports	EUDI-HLOB-4020	847.26												
4 Power Receptacles, 1 Smart USB-A+C Charging, 1 Data Port	EUDI-HLOB-4110	946.16												
4 Power Receptacles, 2 Smart USB-A+C Charging	EUDI-HLOB-4200	1045.06												
5 Power Receptacles, 1 Data Port	EUDI-HLOB-5010	847.26												
5 Power Receptacles, 1 Smart USB-A+C Charging	EUDI-HLOB-5100	946.16												
6 Power Receptacles	EUDI-HLOB-6000	847.26												

Worksurface Power Modules — Enhanced Power Hardware

Top Depth	Top Width	Conduit Length	Housing Color	Port Color	Port	Configuration	Number	Price
3"(76mm)	5"(127mm)	12"(305mm)	Clear Anodized	White	3	1 Power Receptacle, 1 Cable Bay	EUDI-HLOW-1002	\$590.15
						1 Power Receptacle, 2 Data Ports	EUDI-HLOW-1020	590.15
						1 Power Receptacle, 1 Data Port, 1 Smart USB-A+C Charging	EUDI-HLOW-1110	689.05
						1 Power Receptacle, 2 Smart USB-A+C Charging	EUDI-HLOW-1200	787.95
						2 Power Receptacles, 1 Data Port	EUDI-HLOW-2010	590.15
						2 Power Receptacles, 1 Smart USB-A+C Charging	EUDI-HLOW-2100	689.05
						3 Power Receptacles	EUDI-HLOW-3000	590.15
3"(76mm)	6.5"(165mm)				4	1 Power Receptacle, 1 Data Port, 1 Cable Bay	EUDI-HLOW-1012	\$590.15
						1 Power Receptacle, 3 Data Ports	EUDI-HLOW-1030	590.15
						1 Power Receptacle, 1 Smart USB-A+C Charging, 1 Cable Bay	EUDI-HLOW-1102	689.05
						1 Power Receptacle, 3 Smart USB-A+C Charging	EUDI-HLOW-1300	886.85
						2 Power Receptacles, 1 Cable Bay	EUDI-HLOW-2002	590.15
						2 Power Receptacles, 2 Data Ports	EUDI-HLOW-2020	590.15
						2 Power Receptacles, 1 Smart USB-A+C Charging, 1 Data Port	EUDI-HLOW-2110	689.05
						2 Power Receptacles, 2 Smart USB-A+C Charging	EUDI-HLOW-2200	787.95
						3 Power Receptacles, 1 Data Port	EUDI-HLOW-3010	590.15
						3 Power Receptacles, 1 Smart USB-A+C Charging	EUDI-HLOW-3100	689.05
						4 Power Receptacles	EUDI-HLOW-4000	590.15
						3"(76mm)	9.5"(241mm)	
1 Power Receptacle, 1 Smart USB-A+C Charging, 2 Data Ports, 1 Cable Bay	EUDI-HLOW-1122	774.75						
1 Power Receptacle, 1 Smart USB-A+C Charging, 4 Data Ports	EUDI-HLOW-1140	774.75						
1 Power Receptacle, 2 Smart USB-A+C Charging, 1 Data Port, 1 Cable Bay	EUDI-HLOW-1212	873.65						
1 Power Receptacle, 2 Smart USB-A+C Charging, 3 Data Ports	EUDI-HLOW-1230	873.65						
1 Power Receptacle, 3 Smart USB-A+C Charging, 1 Cable Bay	EUDI-HLOW-1302	972.55						
1 Power Receptacle, 3 Smart USB-A+C Charging, 2 Data Ports	EUDI-HLOW-1320	972.55						
1 Power Receptacle, 4 Smart USB-A+C Charging, 1 Data Port	EUDI-HLOW-1410	1071.45						
2 Power Receptacles, 2 Cable Bays	EUDI-HLOW-2004	675.85						
2 Power Receptacles, 2 Data Ports, 1 Cable Bay	EUDI-HLOW-2022	675.85						
2 Power Receptacles, 4 Data Ports	EUDI-HLOW-2040	675.85						
2 Power Receptacles, 1 Smart USB-A+C Charging, 1 Data Port, 1 Cable Bay	EUDI-HLOW-2112	774.75						
2 Power Receptacles, 1 Smart USB-A+C Charging, 3 Data Ports	EUDI-HLOW-2130	774.75						
2 Power Receptacles, 2 Smart USB-A+C Charging, 1 Cable Bay	EUDI-HLOW-2202	873.65						
2 Power Receptacles, 2 Smart USB-A+C Charging, 2 Data Ports	EUDI-HLOW-2220	873.65						
2 Power Receptacles, 3 Smart USB-A+C Charging, 1 Data Port	EUDI-HLOW-2310	972.55						
2 Power Receptacles, 4 Smart USB-A+C Charging	EUDI-HLOW-2400	1071.45						
3 Power Receptacles, 3 Data Ports	EUDI-HLOW-3030	675.85						
3 Power Receptacles, 1 Smart USB-A+C Charging, 1 Cable Bay	EUDI-HLOW-3102	774.75						
3 Power Receptacles, 1 Smart USB-A+C Charging, 2 Data Ports	EUDI-HLOW-3120	774.75						
3 Power Receptacles, 2 Smart USB-A+C Charging, 1 Data Port	EUDI-HLOW-3210	873.65						
3 Power Receptacles, 3 Smart USB-A+C Charging	EUDI-HLOW-3300	972.55						
4 Power Receptacles, 1 Cable Bay	EUDI-HLOW-4002	675.85						
4 Power Receptacles, 2 Data Ports	EUDI-HLOW-4020	675.85						
4 Power Receptacles, 1 Smart USB-A+C Charging, 1 Data Port	EUDI-HLOW-4110	774.75						
4 Power Receptacles, 2 Smart USB-A+C Charging	EUDI-HLOW-4200	873.65						
5 Power Receptacles, 1 Data Port	EUDI-HLOW-5010	675.85						
5 Power Receptacles, 1 Smart USB-A+C Charging	EUDI-HLOW-5100	774.75						
6 Power Receptacles	EUDI-HLOW-6000	675.85						

Worksurface Power Modules — Enhanced Power

Spiral Corded — Height Adjustable

4-Port:

- (2) Power
- (1) Smart USB-A+C
- (1) Data

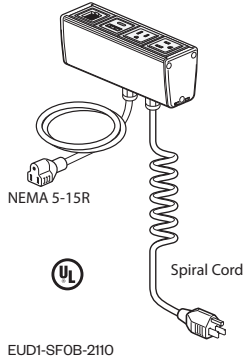

Features

- Includes power module with 3, 4 or 6 ports that can be configured with simplex outlets (NEMA-5-15R), USB charging port (Smart USB-A+C), data ports or cable bay(s) that can accept up to two pull out data/AV cables and mounting hardware.
- Data port accommodate most varieties of field supplied data/ AV jacks.
- Spiral Cord includes 15 amp plug (NEMA 5-15P) and expands to 12'(3658mm) when stretched.
- Auxiliary 24"(610mm) power cord with NEMA 5-15R used to provide power to table motor controller.
- Attaches to surface with use of separately specified mounting brackets.
- The Smart USB-A+C allows for the 20W to be transferred between the 2 ports. If the USB-A is being used, the full wattage is sent to the USB-A, and the same for the USB-C. If both are being used, the wattage is distributed to each port and the port drawing the most power will receive more watts than the one that is not.
- Color option of black anodized housing with black receptacles or clear anodized housing with white receptacles.

To Order, Specify:

- 1) Product number.
(No finish specification required.)

Specification Tips

- **Configuration and quantity of power and data ports cannot be modified in the field.**
- **For use with 120 volt 60 hertz power source only.**
- **For use with:**
 - Planes or Planes LT Model Height Adjustable Tables
 - Planes or Planes LT Model Height Adjustable Bench
 - Upside+ or Upside Model Height Adjustable Tables
- Separately specify attachment hardware for desired application.
- Not for use with cable chain.
- Requires field installation.
- Application may require approval of local authority having jurisdiction (AHJ); ensure compliance before placing orders and installation.

4-Port:

- (4) Power

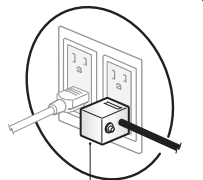
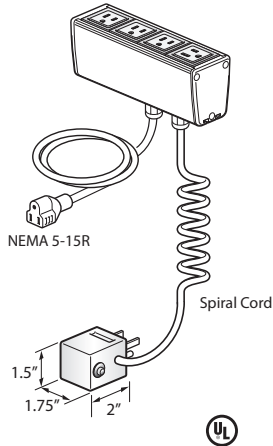

NOTE:
Always Circuit Breaker Plug when more than 3 power outlets specified.

EUDI-SFOB-4000
Class YA

Top Depth	Top Width	Cord Length	Housing Color	Port Color	Port	Configuration	Number	Price
3"(76mm)	6.5"(165mm)	10'(3048mm)-12'(3658mm)	Black Anodized	Black	4	2 Power Receptacles, 1 Smart USB-A+C Charging, 1 Data Port	EUDI-SFOB-2110	\$1047.43
					4	2 Power Receptacles, 2 Smart USB-A+C Charging	EUDI-SFOB-2200	1146.33
		4	3 Power Receptacles, 1 Data Port	EUDI-SFOB-3010	948.53			
		4	3 Power Receptacles, 1 Smart USB-A+C Charging	EUDI-SFOB-3100	1047.43			
		4	4 Power Receptacles	EUDI-SFOB-4000	948.53			
		4	2 Power Receptacles, 1 Smart USB-A+C Charging, 1 Data Port	EUDI-SFOW-2110	\$ 876.02			
		4	2 Power Receptacles, 2 Smart USB-A+C Charging	EUDI-SFOW-2200	974.92			
		4	3 Power Receptacles, 1 Data Port	EUDI-SFOW-3010	777.12			
		4	3 Power Receptacles, 1 Smart USB-A+C Charging	EUDI-SFOW-3100	876.02			
		4	4 Power Receptacles	EUDI-SFOW-4000	777.12			

Worksurface Power Modules — Enhanced Power Cord for Height Adjustable

4-Port:

- (2) Power
- (1) Smart USB-A+C
- (1) Data

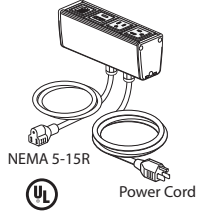

EUDI-SLOB-2110

4-Port:

- (4) Power

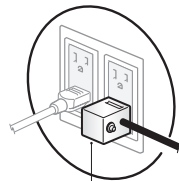
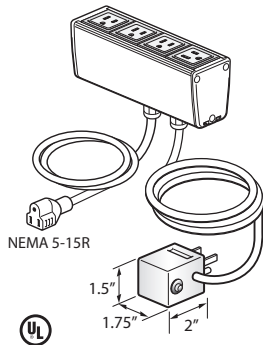

NOTE:
Always Circuit Breaker Plug
when more than 3
power outlets specified.

EUDI-SLOB-4000

Class YA

Features

- Includes power module with 3, 4 or 6 ports that can be configured with simplex outlets (NEMA-5-15R), USB charging port (Smart USB-A+C) , data ports or cable bay(s) that can accept up to two pull out data/AV cables and mounting hardware.
- Data port accommodate most varieties of field supplied data/ AV jacks.
- Corded power module with 15 amp - 12'(3658mm) long cord with plug (NEMA 5-15P).
- Auxiliary 24"(610mm) power cord with NEMA 5-15R used to provide power to table motor controller.
- Attaches to surface with use of separately specified mounting brackets.
- The Smart USB-A+C allows for the 20W to be transferred between the 2 ports. If the USB-A is being used, the full wattage is sent to the USB-A, and the same for the USB-C. If both are being used, the wattage is distributed to each port and the port drawing the most power will receive more watts than the one that is not.
- Color option of black anodized housing with black receptacles or clear anodized housing with white receptacles.

Specification Tips

- **Configuration and quantity of power and data ports cannot be modified in the field.**
- **For use with 120 volt 60 hertz power source only.**
- **For use with:**
 - Planes or Planes LT Model Height Adjustable Tables
 - Planes or Planes LT Model Height Adjustable Benching
 - Upside+ or Upside Model Height Adjustable Tables
- Separately specify attachment hardware for desired application.
- Designed to be used with cable chain.
- Requires field installation.
- Application may require approval of local authority having jurisdiction (AHJ); ensure compliance before placing orders and installation.

To Order, Specify:

- 1) Product number.
(No finish specification required.)

Top Depth	Top Width	Cord Length	Housing Color	Port Color	Port	Port Configuration	Number	Price
3"(76mm)	6.5"(165mm)	10'(3048mm)-12'(3658mm)	Black Anodized	Black	4	2 Power Receptacles, 1 Smart USB-A+C Charging, 1 Data Port	EUDI-SLOB-2110	\$ 1128.00
					4	2 Power Receptacles, 2 Smart USB-A+C Charging	EUDI-SLOB-2200	1226.90
					4	3 Power Receptacles, 1 Data Port	EUDI-SLOB-3010	1029.10
					4	3 Power Receptacles, 1 Smart USB-A+C Charging	EUDI-SLOB-3100	1128.00
					4	4 Power Receptacles	EUDI-SLOB-4000	1029.10
			Clear Anodized	White	4	2 Power Receptacles, 1 Smart USB-A+C Charging, 1 Data Port	EUDI-SLOW-2110	\$ 956.59
					4	2 Power Receptacles, 2 Smart USB-A+C Charging	EUDI-SLOW-2200	1055.49
					4	3 Power Receptacles, 1 Data Port	EUDI-SLOW-3010	857.69
					4	3 Power Receptacles, 1 Smart USB-A+C Charging	EUDI-SLOW-3100	956.59
					4	4 Power Receptacles	EUDI-SLOW-4000	857.69

Worksurface Power Modules — Enhanced Power Brackets

Above Worksurface – Adjustable

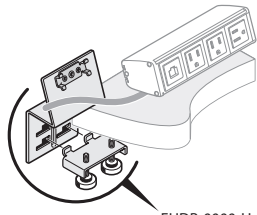

EUDB-0000-H

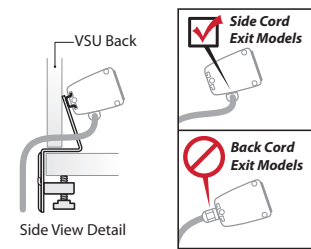

Side View Detail

EUDB-0000-H
Class YA

Features

- Includes bracket and mounting hardware.
- For use with 3, 4 or 6 port Enhanced Power Module and 2-6 port Seamless Enhanced Power Modules.
- Available in black or white.
- Mounts to back edge of 1.18”(30mm) to 2”(51mm) worktop.
- Not for use with a tack board.

Specification Tips

- Specify Enhanced Power Module separately.
- Requires field installation.
- Application may require approval of local authority having jurisdiction (AHJ); ensure compliance before placing orders and installation.

To Order, Specify:

- 1) Product number.
(No finish specification required.)

Height	Width	Length	Description	Number	Price
4”(102mm)	3.5”(89mm)	3.5”(89mm)	Black Bracket	EUDB-0000-HB	\$89.96
			White Bracket	EUDB-0000-HW	89.96

Above Worksurface – Adjustable for Knife Edge

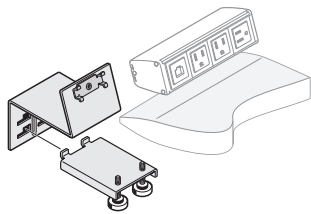

EUDB-0000-NB

EUDB-0000-N
Class YA – GSA: Open Market



Features

- Includes bracket and mounting hardware.
- For use with 3, 4 or 6 port Enhanced Power Module and 2-6 port Seamless Enhanced Power Modules.
- Available in black or white.
- Mounts to worksurface edge.

Specification Tips

- Designed to be used with 1.18”(30mm) thick surfaces with clear space below.
- Specify Enhanced Power Module separately.
- Requires field installation.
- Application may require approval of local authority having jurisdiction (AHJ); ensure compliance before placing orders and installation.
- Designed to be used with knife edge worksurfaces.

To Order, Specify:

- 1) Product number.
(No finish specification required.)

Height	Width	Length	Description	Number	Price
4”(102mm)	3.5”(89mm)	3.5”(89mm)	Black Bracket	EUDB-0000-NB	\$129.79
			White Bracket	EUDB-0000-NW	129.79

Worksurface Power Modules — Enhanced Power Brackets

Above Worksurface – Adjustable with Tackboard Offset

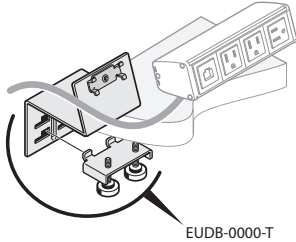

EUDB-0000-T

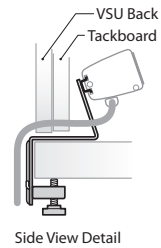

EUDB-0000-T
Class YA

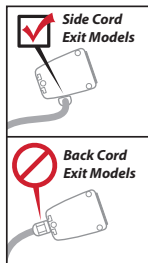

Features

- Includes bracket and mounting hardware.
- For use with 3, 4 or 6 port Enhanced Power Module and 2-6 port Seamless Enhanced Power Modules.
- Available in black or white.
- Mounts to back edge of 1.18”(30mm) to 2”(51mm) worktop when a tackboard or slat, glass, laminate or veneer tile is present.

Specification Tips

- Specify Enhanced Power Module separately.
- Requires field installation.
- Application may require approval of local authority having jurisdiction (AHJ); ensure compliance before placing orders and installation.

To Order, Specify:

- 1) Product number.
(No finish specification required.)

Height	Width	Length	Description	Number	Price
4”(102mm)	3.5”(89mm)	3.5”(89mm)	Black Bracket	EUDB-0000-TB	\$89.96
			White Bracket	EUDB-0000-TW	89.96

Above Worksurface – Fixed

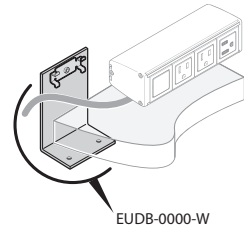

EUDB-0000-W

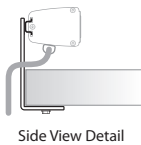

EUDB-0000-W
Class YA

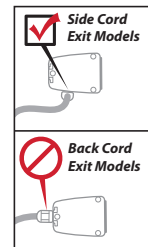

Features

- Includes bracket and mounting hardware.
- For use with 3, 4 or 6 port Enhanced Power Module and 2-6 port Seamless Enhanced Power Modules.
- Available in black or white.
- Mounts under worksurface with Enhanced Power Module above worksurface.

Specification Tips

- Designed to be used with 1.18” (30mm) thick surfaces with clear space below.
- Specify Enhanced Power Module separately.
- Requires field installation.
- Application may require approval of local authority having jurisdiction (AHJ); ensure compliance before placing orders and installation.

To Order, Specify:

- 1) Product number.
(No finish specification required.)

Height	Width	Length	Description	Number	Price
4.25”(107mm)	3”(76mm)	2”(51mm)	Black Bracket	EUDB-0000-WB	\$89.96
			White Bracket	EUDB-0000-WW	89.96

Worksurface Power Modules — Enhanced Power Brackets

Under Worksurface – Fixed

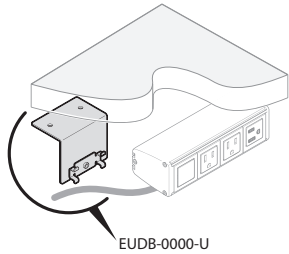

Features

- Includes bracket and mounting hardware.
- For use with 3, 4 or 6 port Enhanced Power Module and 2-6 port Seamless Enhanced Power Modules.
- Available in black or white.
- Mounts under worksurface with offset to accommodate most transformer plugs.

To Order, Specify:

- 1) Product number.
(No finish specification required.)

Specification Tips

- Designed to be used with 1.18”(30mm) thick surfaces with clear space below.
- Specify Enhanced Power Module separately.
- Requires field installation.
- Application may require approval of local authority having jurisdiction (AHJ); ensure compliance before placing orders and installation.

Height	Width	Length	Description	Number	Price
2”(51mm)	33”(838mm)	2.5”(64mm)	Black Bracket	EUDB-0000-UB	\$89.96
			White Bracket	EUDB-0000-UW	89.96

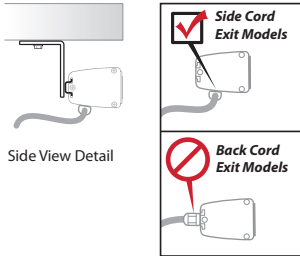

EUDB-0000-U
Class YA

For Use with X Series

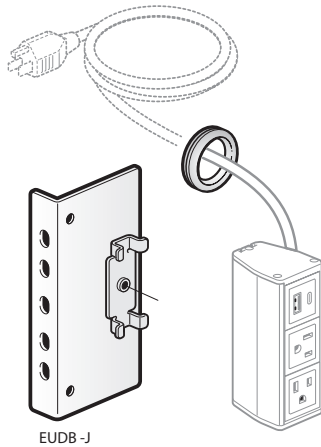

Features

- Includes bracket, grommet and mounting hardware.
- Field installed.

To Order, Specify:

- 1) Product number.
(No finish specification required.)

Specification Tips

- Bracket designed to be used with Enhanced Power Module only.
- Designed to be used in X Series open storage cavities of lockers, group lockers, cubby lockers and combination units.
- Cannot be used in drawers or personal storage towers.
- A 1.25”(32mm) diameter Greenlee punch is recommended to punch the power hole through the back of our products (lockers).
- Application may require approval of local authority having jurisdiction (AHJ); ensure compliance before placing orders and installation.

Height	Depth	Width	Trim Color	Number	Price
5”(127mm)	1.125”(29mm)	2.375”(60mm)	Black	EUDB-0000-JB	\$89.96
			White	EUDB-0000-JW	89.96

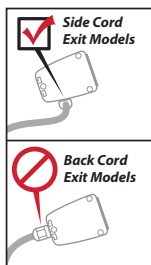

EUDB-J
Class YA

Worksurface Power Modules — Classic Power

Classic Power Module

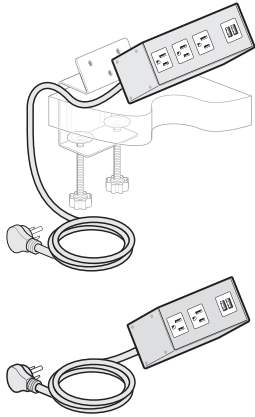

EUF1-PFOB
Class YA – GSA: Open Market

Features

- Includes power module with 3 or 4 ports configured with simplex outlets (NEMA-5-15R), USB charging port (with two USB outlets).
- Corded power module with 15 amp - 6'(1829mm) or 10'(3048mm) long cord with plug (NEMA 5-15P).
- USB Charging Port consists of two 5V USB 2.0 style A outlets, each with 10.5W (2.1Amp) charging capacity.
- Attaches to surface with separately specified mounting brackets.
- Color option of black or white front.

Specification Tips

- Not for use with tackboards.
- Configuration and quantity of power and USB ports cannot be modified in the field.
- For use with 120 volt 60 hertz power source only.
- Requires field installation.
- Application may require approval of local authority having jurisdiction (AHJ); ensure compliance before placing orders and installation.
- Separately specified:
 - Mounting Bracket

To Order, Specify:

- 1) Product number.
(No finish specification required.)

Depth	Width	Cord Length	Trim Color	Color	Port	Configuration	Number	Price
Corded								
		6'(1829mm)	Black	Black	3	2 Power Receptacles, 1 USB Charging	EUF1-PFOB-21000	\$286.81
					4	3 Power Receptacles, 1 USB Charging	EUF1-PFOB-31000	301.64
		6'(1829mm)	White	White	3	2 Power Receptacles, 1 USB Charging	EUF1-PFOW-21000	\$286.81
					4	3 Power Receptacles, 1 USB Charging	EUF1-PFOW-31000	301.64
		10'(3048mm)	Black	Black	3	2Power Receptacles, 1 USB Charging	EUF1-PJOB-21000	\$308.70
					4	3 Power Receptacles, 1 USB Charging	EUF1-PJOB-31000	323.53
		10'(3048mm)	White	White	3	2 Power Receptacles, 1 USB Charging	EUF1-PJOW-21000	\$308.70
					4	3 Power Receptacles, 1 USB Charging	EUF1-PJOW-31000	323.53

Worksurface Power Modules — Classic Power Brackets

Angled

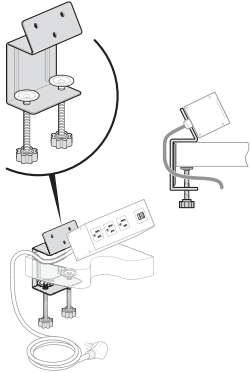

EUFB-0000-AB
Class YA

Features

- Includes one Classic Power Module mounting bracket and mounting hardware.
- Fixed Bracket mounts Classic Power Module to edge of worksurface with thumb screws for ease of relocation.

Specification Tips

- Accommodates 1.18”(30mm) and 2”(51mm) thick tops with clear space below.
- Classic Power Module applications should be reviewed by local authorities (electrical inspector) prior to ordering due to varying local codes.
- Recommended for use on panel mounted worksurface or freestanding table top.

To Order, Specify:

- 1) Product number.
(No finish specification required.)

Description	Number	Price
Black	EUFB-0000-AB	\$68.80
White	EUFB-0000-AW	68.80

Vertical

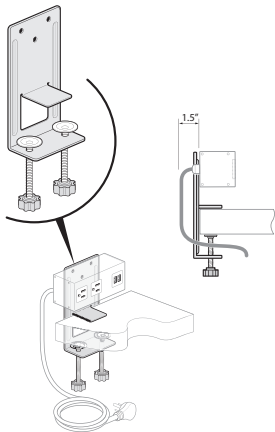

EUFB-0000-SB
Class YA

Features

- Includes one Classic Power Module mounting bracket and mounting hardware.
- Adjustable bracket mounts Classic Power Module to edge of worksurface with thumb screws for ease of relocation.

Specification Tips

- Accommodates 1.18”(30mm) and 2”(51mm) thick tops with clear space below.
- Adjustable Classic Power Module Bracket may interfere with Screen application.
- Classic Power Module applications should be reviewed by local authorities (electrical inspector) prior to ordering due to varying local codes.
- Recommended for use on freestanding table top.

To Order, Specify:

- 1) Product number.
(No finish specification required.)

Description	Number	Price
Black	EUFB-0000-SB	\$68.80
White	EUFB-0000-SW	68.80

Under Surface

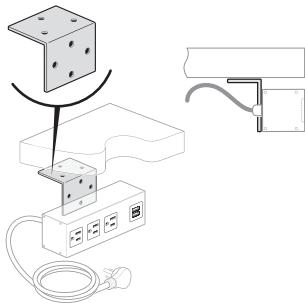

EUFB-0000-UB
Class YA

Features

- Includes one Classic Power Module mounting bracket and mounting hardware.
- Under Surface bracket mounts Classic Power Module under worksurface with mounting screws.

Specification Tips

- Under surface Classic Power Module bracket may be used on top of worksurface in restricted reach (ADA) applications. Mounting screws will deface top of worksurface.
- Classic Power Module applications should be reviewed by local authorities (electrical inspector) prior to ordering due to varying local codes.

To Order, Specify:

- 1) Product number.
(No finish specification required.)

Description	Number	Price
Black	EUFB-0000-UB	\$68.80
White	EUFB-0000-UW	68.80

Worksurface Power Modules — Flip Top

Smooth Bezel – Corded – Single-Sided

Power, Data and USB

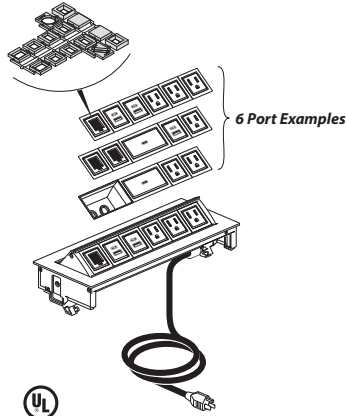

EUCI-PFOP-311010

(2) Power

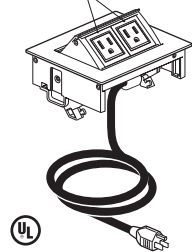

EUCI-PFOP-200000

(2) Power
(1) Smart USB-A+C
(1) Data Port

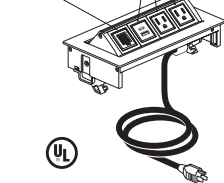

EUCI-PFOP-210010

(4) Power

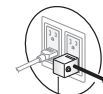
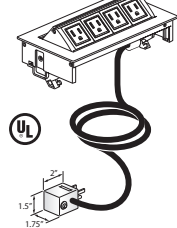

NOTE:
Always Circuit Breaker Plug when more than three power outlets specified.

EUCI-PFOP-400000

Class YA – GSA: Open Market

Features

- Includes flip top with smooth bezel module with 2, 4, or 6 ports configured with simplex outlets (NEMA 5-15R), USB charging port (USB-C 60W, Smart USB-A+C), data port(s) or cable bay, and mounting hardware.
- The Smart USB-A+C allows for the 20W to be transferred between the 2 ports. If the USB-A is being used, the full wattage is sent to the USB-A, and the same for the USB-C. If both are being used, the wattage is distributed to each port and the port drawing the most power will receive more watts than the one that is not.
- Data jack adapters accommodate most varieties of field supplied data jacks or separately specified AV cables. Occupies one port.
- Each cable bay can accept up to two pull out data/AV cables. Occupies two ports.
- Smart USB-A+C can provide fast charge for a mobile phone and tablets. Occupies one charging port.
- USB-C 60W can charge phone, tablets and some laptops. Occupies two ports.
- Smooth bezel is painted and features non mitered corners.
- Port color is either black or white based on smooth bezel color.
- Flip top unit is flush mounted with spring release cover.
- Flip top unit overall height is 2.75"(70mm) and will extend below the table top.
- Corded power module available with 15 amp - 6'(1829mm) or 10'(3048mm) long cord with plug (NEMA 5-15P).
- Ships assembled.

Specification Tips

- Designed to be used with 1.18"(30mm) and 2"(51mm) thick surfaces with clear space below.
- **Configuration and quantity of ports cannot be modified in the field.**
- **For use with 120 volt 60 hertz power source only.**
- Requires field installation.
- Specify factory cut hole or field cut hole as required.
- Specify AV cables separately.
- Cable Bay requires cables less than 0.3"(7.6mm) diameter.
- Corded flip top units with four or more receptacles utilize a circuit breaker plug that may block adjacent building receptacle outlet.
- Application may require approval of local authority having jurisdiction (AHJ); ensure compliance before placing orders and installation.

To Order, Specify:

- 1) Product number.
- 2) Finish color for Bezel/Port.
 - TR-PM1 Silver/White
 - TR-PM2 Midnight Black/Black
 - TR-PM8 Matte White/White
 - TR-PM9 Matte Grey/Black

Note: Order flip top units to match flip top unit cutout option specified for each top (A/B, F/V or J/K).

2, 4, and 6 Port Examples

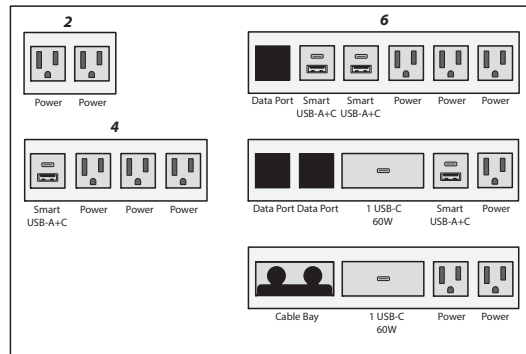

Worksurface Power Modules — Flip Top

Smooth Bezel – Corded – Single-Sided

Bezel Depth	Bezel Width	Cord Length	Port	Configuration	Cutout		Price
					Options	Code Number	
6'(1829mm)			2	1 Receptacle, 1 Data Port	A, B	EUC1-PFOP-100010	\$ 707.29
				1 Receptacle, 1 Smart USB-A+C Charging	A, B	EUC1-PFOP-101000	810.81
				2 Receptacles	A, B	EUC1-PFOP-200000	707.29
6'(1829mm)			4	1 Receptacle, 1 Smart USB-A+C Charging, 1 Data Port	F, V	EUC1-PFOP-111010	\$ 943.07
				1 Receptacle, 1 Smart USB-A+C Charging, 1 Cable Bay	F, V	EUC1-PFOP-101001	839.55
				1 Receptacle, 1 USB-C 60W Charging, 1 Data Port	F, V	EUC1-PFOP-100110	1095.29
				2 Receptacles, 1 Cable Bay	F, V	EUC1-PFOP-200001	736.03
				2 Receptacles, 1 USB-C 60W Charging	F, V	EUC1-PFOP-200100	1095.29
				2 Receptacles, 1 Smart USB-A+C Charging, 1 Data Port	F, V	EUC1-PFOP-201010	839.55
				2 Receptacles, 2 Data Ports	F, V	EUC1-PFOP-200020	736.03
				2 Receptacles, 2 Smart USB-A+C Charging	F, V	EUC1-PFOP-202000	943.07
				3 Receptacles, 1 Data Port	F, V	EUC1-PFOP-300010	736.03
				3 Receptacles, 1 Smart USB-A+C Charging	F, V	EUC1-PFOP-301000	839.55
				4 Receptacles	F, V	EUC1-PFOP-400000	736.03
				6'(1829mm)			6
1 Receptacle, 1 USB-C 60W Charging, 2 Data Ports	J, K	EUC1-PFOP-110120	1213.18				
1 Receptacle, 1 Smart USB-A+C Charging, 2 Data Ports, 1 Cable Bay	J, K	EUC1-PFOP-101021	853.92				
1 Receptacle, 1 USB-C 60W Charging, 1 Data Port, 1 Cable Bay	J, K	EUC1-PFOP-100111	1109.66				
2 Receptacles, 1 Smart USB-A+C Charging, 1 Cable Bay	J, K	EUC1-PFOP-211001	957.44				
2 Receptacles, 1 Smart USB-A+C Charging, 2 Data Ports	J, K	EUC1-PFOP-211020	957.44				
2 Receptacles, 1 Smart USB-A+C Charging, 3 Data Ports	J, K	EUC1-PFOP-201030	853.92				
2 Receptacles, 1 USB-C 60W Charging, 1 Cable Bay	J, K	EUC1-PFOP-200101	1109.66				
2 Receptacles, 1 USB-C 60W Charging, 2 Data Ports	J, K	EUC1-PFOP-200120	1109.66				
2 Receptacles, 2 Data Ports, 1 Cable Bay	J, K	EUC1-PFOP-200021	750.40				
2 Receptacles, 4 Data Ports	J, K	EUC1-PFOP-200040	750.40				
3 Receptacles, 1 Data Port, 1 Cable Bay	J, K	EUC1-PFOP-300011	750.40				
3 Receptacles, 1 USB-A Charging, 1 Smart USB-A+C Charging, 1 Data Port	J, K	EUC1-PFOP-311010	957.44				
3 Receptacles, 1 Smart USB-A+C Charging, 1 Cable Bay	J, K	EUC1-PFOP-301001	853.92				
3 Receptacles, 1 Smart USB-A+C Charging, 2 Data Ports	J, K	EUC1-PFOP-301020	853.92				
3 Receptacles, 1 USB-C 60W Charging, 1 Data Port	J, K	EUC1-PFOP-300110	1109.66				
3 Receptacles, 3 Data Ports	J, K	EUC1-PFOP-300030	750.40				
4 Receptacles, 1 Cable Bay	J, K	EUC1-PFOP-400001	750.40				
4 Receptacles, 1 Smart USB-A+C Charging, 1 Data Port	J, K	EUC1-PFOP-401010	853.92				
4 Receptacles, 1 USB-C 60W Charging	J, K	EUC1-PFOP-400100	1109.66				
4 Receptacles, 2 Data Ports	J, K	EUC1-PFOP-400020	750.40				
4 Receptacles, 2 Smart USB-A+C Charging	J, K	EUC1-PFOP-402000	957.44				
5 Receptacles, 1 Data Port	J, K	EUC1-PFOP-500010	750.40				
5 Receptacles, 1 Smart USB-A+C Charging	J, K	EUC1-PFOP-501000	853.92				
6 Receptacles	J, K	EUC1-PFOP-600000	750.40				

Worksurface Power Modules — Flip Top

Smooth Bezel – Corded – Single-Sided

Bezel Depth	Bezel Width	Cord Length	Port	Configuration	Cutout Code	Options	Number	Price
		10'(3048mm)	2	1 Receptacle, 1 Data Port	A, B		EUC1-PJ0P-100010	\$ 777.78
				1 Receptacle, 1 Smart USB-A+C Charging	A, B		EUC1-PJ0P-101000	881.30
				2 Receptacles	A, B		EUC1-PJ0P-200000	777.78
			4	1 Receptacle, 1 Dual USB-A Charging, 1 Smart USB-A+C Charging, 1 Data Port	F, V		EUC1-PJ0P-111010	\$1013.56
				1 Receptacle, 1 Smart USB-A+C Charging, 1 Cable Bay	F, V		EUC1-PJ0P-101001	910.04
				1 Receptacle, 1 USB-C 60W Charging, 1 Data Port	F, V		EUC1-PJ0P-100110	1165.78
				2 Receptacles, 1 Cable Bay	F, V		EUC1-PJ0P-200001	806.52
				2 Receptacles, 1 Smart USB-A+C Charging, 1 Data Port	F, V		EUC1-PJ0P-201010	910.04
				2 Receptacles, 1 USB-C 60W Charging	F, V		EUC1-PJ0P-200100	1165.78
				2 Receptacles, 2 Data Ports	F, V		EUC1-PJ0P-200020	806.52
				2 Receptacles, 2 Smart USB-A+C Charging	F, V		EUC1-PJ0P-202000	1013.56
				3 Receptacles, 1 Data Port	F, V		EUC1-PJ0P-300010	806.52
				3 Receptacles, 1 Smart USB-A+C Charging	F, V		EUC1-PJ0P-301000	910.04
				4 Receptacles	F, V		EUC1-PJ0P-400000	806.52
			6	1 Receptacle, 1 Dual USB-A Charging, 1 Smart USB-A+C Charging, 1 Data Port, 1 Cable Bay	J, K		EUC1-PJ0P-111011	\$1027.93
				1 Receptacle, 1 Dual USB-A Charging, 1 USB-C 60W Charging, 2 Data Ports	J, K		EUC1-PJ0P-110120	1283.67
				1 Receptacle, 1 Smart USB-A+C Charging, 2 Data Ports, 1 Cable Bay	J, K		EUC1-PJ0P-101021	924.41
				1 Receptacle, 1 USB-C 60W Charging, 1 Data Port, 1 Cable Bay	J, K		EUC1-PJ0P-100111	1180.15
				2 Receptacles, 1 Dual USB-A Charging, 1 Smart USB-A+C Charging, 1 Cable Bay	J, K		EUC1-PJ0P-211001	1027.93
				2 Receptacles, 1 Dual USB-A Charging, 1 Smart USB-A+C Charging, 2 Data Ports	J, K		EUC1-PJ0P-211020	1027.93
				2 Receptacles, 1 Smart USB-A+C Charging, 3 Data Ports	J, K		EUC1-PJ0P-201030	924.41
				2 Receptacles, 1 USB-C 60W Charging, 1 Cable Bay	J, K		EUC1-PJ0P-200101	1180.15
				2 Receptacles, 1 USB-C 60W Charging, 2 Data Ports	J, K		EUC1-PJ0P-200120	1180.15
				2 Receptacles, 2 Data Ports, 1 Cable Bay	J, K		EUC1-PJ0P-200021	820.89
				2 Receptacles, 4 Data Ports	J, K		EUC1-PJ0P-200040	820.89
				3 Receptacles, 1 Data Port, 1 Cable Bay	J, K		EUC1-PJ0P-300011	820.89
				3 Receptacles, 1 Dual USB-A Charging, 1 Smart USB-A+C Charging, 1 Data Port	J, K		EUC1-PJ0P-311010	1027.93
				3 Receptacles, 1 Smart USB-A+C Charging, 1 Cable Bay	J, K		EUC1-PJ0P-301001	924.41
				3 Receptacles, 1 Smart USB-A+C Charging, 2 Data Ports	J, K		EUC1-PJ0P-301020	924.41
				3 Receptacles, 1 USB-C 60W Charging, 1 Data Port	J, K		EUC1-PJ0P-300110	1180.15
				3 Receptacles, 3 Data Ports	J, K		EUC1-PJ0P-300030	820.89
				4 Receptacles, 1 Cable Bay	J, K		EUC1-PJ0P-400001	820.89
				4 Receptacles, 1 Smart USB-A+C Charging, 1 Data Port	J, K		EUC1-PJ0P-401010	924.41
				4 Receptacles, 1 USB-C 60W Charging	J, K		EUC1-PJ0P-400100	1180.15
				4 Receptacles, 2 Data Ports	J, K		EUC1-PJ0P-400020	820.89
				4 Receptacles, 2 Smart USB-A+C Charging	J, K		EUC1-PJ0P-402000	1027.93
				5 Receptacles, 1 Data Port	J, K		EUC1-PJ0P-500010	820.89
				5 Receptacles, 1 Smart USB-A+C Charging	J, K		EUC1-PJ0P-501000	924.41
				6 Receptacles	J, K		EUC1-PJ0P-600000	820.89

Worksurface Power Modules — Flip Top

Smooth Bezel — Corded — Double-Sided

Power, Data and USB

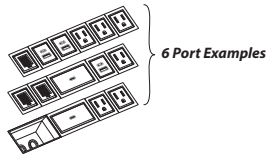
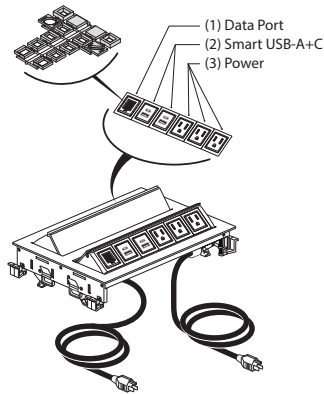

EUC2-PFOP-311010

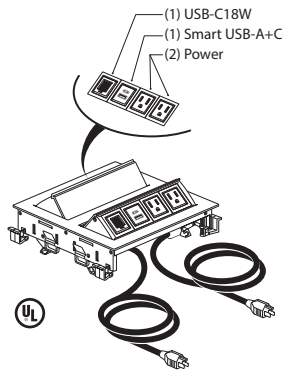

EUC2-PFOP-210010

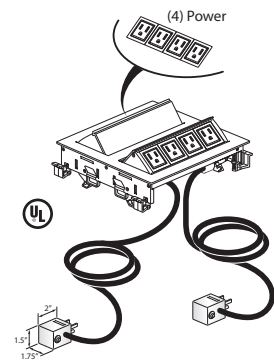

NOTE:
Always Circuit Breaker Plug when more than three power outlets specified.

EUC2-PFOP-400000
Class YA - GSA: Open Market

Features

- Includes double flip top with smooth bezel module with 2, 4, or 6 ports configured with simplex outlets (NEMA 5-15R), USB charging port (USB-C 60W, Smart USB-A+C), data port(s) or cable bay, and mounting hardware.
- The Smart USB-A+C allows for the 20W to be transferred between the 2 ports. If the USB-A is being used, the full wattage is sent to the USB-A, and the same for the USB-C. If both are being used, the wattage is distributed to each port and the port drawing the most power will receive more watts than the one that is not.
- Data jack adapters accommodate most varieties of field supplied data jacks or separately specified AV cables. Occupies one port.
- Each cable bay can accept up to two pull out data/AV cables. Occupies two ports.
- Smart USB-A+C can provide fast charge for a mobile phone and tablets. Occupies one charging port.
- USB-C 60W can charge phone, tablets and some laptops. Occupies two ports.
- Smooth bezel is painted and features non mitered corners.
- Port color is either black or white based on smooth bezel color.
- Flip top unit is flush mounted with spring release cover.
- Flip top unit overall height is 2.75"(70mm) and will extend below the table top.
- Corded power module available with two 15 amp - 6'(1829mm) or 10'(3048mm) long cord with plug (NEMA 5-15P).
- Ships assembled.

Specification Tips

- Designed to be used with 1.18"(30mm) and 2"(51mm) thick surfaces with clear space below.
- **Configuration and quantity of ports cannot be modified in the field.**
- **For use with 120 volt 60 hertz power source only.**
- Requires field installation.
- Specify factory cut hole or field cut hole as required.
- Specify AV cables separately.
- Cable Bay requires cables less than 0.3"(8mm) diameter.
- Corded flip top units with four receptacles utilize a circuit breaker plug that may block adjacent building receptacle outlet.
- Application may require approval of local authority having jurisdiction (AHJ); ensure compliance before placing orders and installation.

Notes: Two cord feeds are provided from the double-sided flip top unit.

To Order, Specify:

- 1) Product number.
- 2) Finish color for Bezel/Port.

TR-PM1	Silver/White
TR-PM2	Midnight Black/Black
TR-PM8	Matte White/White
TR-PM9	Matte Grey/Black

Note: Order flip top units to match flip top unit cutout option specified for each top (M/P or Q/T).

Worksurface Power Modules — Flip Top

Smooth Bezel — Corded — Double-Sided

Bezel Depth	Bezel Width	Cord Length	Port	Configuration	Cutout Code	Options	Number	Price				
6	1829mm		4	1 Receptacle, 2 Smart USB-A+C Charging, 1 Data Port	M, P		EUC2-PFOP-111010	\$1702.65				
				1 Receptacle, 1 Smart USB-A+C Charging, 1 Cable Bay	M, P		EUC2-PFOP-101001	1599.13				
				1 Receptacle, 1 USB-C 60W Charging, 1 Data Port	M, P		EUC2-PFOP-100110	1854.87				
				2 Receptacles, 1 USB-C 60W Charging	M, P		EUC2-PFOP-200100	1854.87				
				2 Receptacles, 1 Cable Bay	M, P		EUC2-PFOP-200001	1495.61				
				2 Receptacles, 1 Smart USB-A+C Charging, 1 Data Port	M, P		EUC2-PFOP-201010	1599.13				
				2 Receptacles, 2 Data Ports	M, P		EUC2-PFOP-200020	1495.61				
				2 Receptacles, 2 Smart USB-A+C Charging	M, P		EUC2-PFOP-202000	1702.65				
				3 Receptacles, 1 Data Port	M, P		EUC2-PFOP-300010	1495.61				
				3 Receptacles, 1 Smart USB-A+C Charging	M, P		EUC2-PFOP-301000	1599.13				
				4 Receptacles	M, P		EUC2-PFOP-400000	1495.61				
				6			6	1 Receptacle, 2 Smart USB-A+C Charging, 1 Data Port, 1 Cable Bay	Q, T		EUC2-PFOP-111011	\$1760.11
								1 Receptacle, 1 USB-C 60W Charging, 2 Data Ports	Q, T		EUC2-PFOP-110120	2015.85
								1 Receptacle, 1 Smart USB-A+C Charging, 2 Data Ports, 1 Cable Bay	Q, T		EUC2-PFOP-101021	1656.59
1 Receptacle, 1 USB-C 60W Charging, 1 Data Port, 1 Cable Bay	Q, T		EUC2-PFOP-100111					1912.33				
2 Receptacles, 2 Smart USB-A+C Charging, 1 Cable Bay	Q, T		EUC2-PFOP-211001					1760.11				
2 Receptacles, 2 Smart USB-A+C Charging, 2 Data Ports	Q, T		EUC2-PFOP-211020					1760.11				
2 Receptacles, 1 Smart USB-A+C Charging, 3 Data Ports	Q, T		EUC2-PFOP-201030					1656.59				
2 Receptacles, 1 USB-C 60W Charging, 1 Cable Bay	Q, T		EUC2-PFOP-200101					1912.33				
2 Receptacles, 1 USB-C 60W Charging, 2 Data Ports	Q, T		EUC2-PFOP-200120					1912.33				
2 Receptacles, 2 Data Ports, 1 Cable Bay	Q, T		EUC2-PFOP-200021					1553.07				
2 Receptacles, 4 Data Ports	Q, T		EUC2-PFOP-200040					1553.07				
3 Receptacles, 1 Data Port, 1 Cable Bay	Q, T		EUC2-PFOP-300011					1553.07				
3 Receptacles, 2 Smart USB-A+C Charging, 1 Data Port	Q, T		EUC2-PFOP-311010					1760.11				
3 Receptacles, 1 Smart USB-A+C Charging, 1 Cable Bay	Q, T		EUC2-PFOP-301001					1656.59				
3 Receptacles, 1 Smart USB-A+C Charging, 2 Data Ports	Q, T		EUC2-PFOP-301020					1656.59				
3 Receptacles, 1 USB-C 60W Charging, 1 Data Port	Q, T		EUC2-PFOP-300110					1912.33				
3 Receptacles, 3 Data Ports	Q, T		EUC2-PFOP-300030					1553.07				
4 Receptacles, 1 Cable Bay	Q, T		EUC2-PFOP-400001					1553.07				
4 Receptacles, 1 Smart USB-A+C Charging, 1 Data Port	Q, T		EUC2-PFOP-401010					1656.59				
4 Receptacles, 1 USB-C 60W Charging	Q, T		EUC2-PFOP-400100					1912.33				
4 Receptacles, 2 Data Ports	Q, T		EUC2-PFOP-400020					1553.07				
4 Receptacles, 2 Smart USB-A+C Charging	Q, T		EUC2-PFOP-402000					1760.11				
5 Receptacles, 1 Data Port	Q, T		EUC2-PFOP-500010	1553.07								
5 Receptacles, 1 Smart USB-A+C Charging	Q, T		EUC2-PFOP-501000	1656.59								
6 Receptacles	Q, T		EUC2-PFOP-600000	1553.07								

Worksurface Power Modules — Flip Top

Smooth Bezel — Corded — Double-Sided

Bezel Depth	Bezel Width	Cord Length	Port	Configuration	Cutout Code Options	Number	Price				
10'(3048mm)			4	1 Receptacle, 2 Smart USB-A+C Charging, 1 Data Port	M, P	EUC2-PJ0P-111010	\$ 1773.14				
				1 Receptacle, 1 Smart USB-A+C Charging, 1 Cable Bay	M, P	EUC2-PJ0P-101001	1669.62				
				1 Receptacle, 1 USB-C 60W Charging, 1 Data Port	M, P	EUC2-PJ0P-100110	1925.36				
				2 Receptacles, 1 USB-C 60W Charging	M, P	EUC2-PJ0P-200100	1925.36				
				2 Receptacles, 1 Cable Bay	M, P	EUC2-PJ0P-200001	1566.10				
				2 Receptacles, 1 Smart USB-A+C Charging, 1 Data Port	M, P	EUC2-PJ0P-201010	1669.62				
				2 Receptacles, 2 Data Ports	M, P	EUC2-PJ0P-200020	1566.10				
				2 Receptacles, 2 Smart USB-A+C Charging	M, P	EUC2-PJ0P-202000	1773.14				
				3 Receptacles, 1 Data Port	M, P	EUC2-PJ0P-300010	1566.10				
				3 Receptacles, 1 Smart USB-A+C Charging	M, P	EUC2-PJ0P-301000	1669.62				
				4 Receptacles	M, P	EUC2-PJ0P-400000	1566.10				
				6			6	1 Receptacle, 2 Smart USB-A+C Charging, 1 Data Port, 1 Cable Bay	Q, T	EUC2-PJ0P-111011	\$ 1830.60
								1 Receptacle, 1 USB-C 60W Charging, 2 Data Ports	Q, T	EUC2-PJ0P-110120	2086.34
								1 Receptacle, 1 Smart USB-A+C Charging, 2 Data Ports, 1 Cable Bay	Q, T	EUC2-PJ0P-101021	1727.08
1 Receptacle, 1 USB-C 60W Charging, 1 Data Port, 1 Cable Bay	Q, T	EUC2-PJ0P-100111	1982.82								
2 Receptacles, 2 Smart USB-A+C Charging, 1 Cable Bay	Q, T	EUC2-PJ0P-211001	1830.60								
2 Receptacles, 2 Smart USB-A+C Charging, 2 Data Ports	Q, T	EUC2-PJ0P-211020	1830.60								
2 Receptacles, 1 Smart USB-A+C Charging, 3 Data Ports	Q, T	EUC2-PJ0P-201030	1727.08								
2 Receptacles, 1 USB-C 60W Charging, 1 Cable Bay	Q, T	EUC2-PJ0P-200101	1982.82								
2 Receptacles, 1 USB-C 60W Charging, 2 Data Ports	Q, T	EUC2-PJ0P-200120	1982.82								
2 Receptacles, 2 Data Ports, 1 Cable Bay	Q, T	EUC2-PJ0P-200021	1623.56								
2 Receptacles, 4 Data Ports	Q, T	EUC2-PJ0P-200040	1623.56								
3 Receptacles, 1 Data Port, 1 Cable Bay	Q, T	EUC2-PJ0P-300011	1623.56								
3 Receptacles, 2 Smart USB-A+C Charging, 1 Data Port	Q, T	EUC2-PJ0P-311010	1830.60								
3 Receptacles, 1 Smart USB-A+C Charging, 1 Cable Bay	Q, T	EUC2-PJ0P-301001	1727.08								
3 Receptacles, 1 Smart USB-A+C Charging, 2 Data Ports	Q, T	EUC2-PJ0P-301020	1727.08								
3 Receptacles, 1 USB-C 60W Charging, 1 Data Port	Q, T	EUC2-PJ0P-300110	1982.82								
3 Receptacles, 3 Data Ports	Q, T	EUC2-PJ0P-300030	1623.56								
4 Receptacles, 1 Cable Bay	Q, T	EUC2-PJ0P-400001	1623.56								
4 Receptacles, 1 Smart USB-A+C Charging, 1 Data Port	Q, T	EUC2-PJ0P-401010	1727.08								
4 Receptacles, 1 USB-C 60W Charging	Q, T	EUC2-PJ0P-400100	1982.82								
4 Receptacles, 2 Data Ports	Q, T	EUC2-PJ0P-400020	1623.56								
4 Receptacles, 2 Smart USB-A+C Charging	Q, T	EUC2-PJ0P-402000	1830.60								
5 Receptacles, 1 Data Port	Q, T	EUC2-PJ0P-500010	1623.56								
5 Receptacles, 1 Smart USB-A+C Charging	Q, T	EUC2-PJ0P-501000	1727.08								
6 Receptacles	Q, T	EUC2-PJ0P-600000	1623.56								

Worksurface Power Modules — Flip Top

Smooth Bezel — Hardwire — Single-Sided

Power, Data and USB

Features

- Includes flip top with smooth bezel module with 2, 4, or 6 ports configured with simplex outlets (NEMA 5-15R), USB charging port (USB-A, USB-C 60W, Smart USB-A+C), data port(s) or cable bay, and mounting hardware.
- The Smart USB-A+C allows for the 20W to be transferred between the 2 ports. If the USB-A is being used, the full wattage is sent to the USB-A, and the same for the USB-C. If both are being used, the wattage is distributed to each port and the port drawing the most power will receive more watts than the one that is not.
- Data jack adapters accommodate most varieties of field supplied data jacks or separately specified AV cables. Occupies one port.
- Each cable bay can accept up to two pull out data/AV cables. Occupies two ports.
- Smart USB-A+C can provide fast charge for a mobile phone and tablets. Occupies one charging port.
- USB-C 60W can charge phone, tablets and some laptops. Occupies two ports.
- Smooth bezel is painted and features non mitered corners.
- Port color is either black or white based on smooth bezel color.
- Flip top unit is flush mounted with spring release cover.
- Flip top unit overall height is 2.75"(70mm) and will extend below the table top.
- Hardwired power module with 6'(1829mm) or 10'(3048mm) long flexible metal conduit feed, 0.5"(13mm) conduit fitting and wires for hardwire connection.
- Ships assembled.

Specification Tips

- Designed to be used with 1.18"(30mm) and 2"(51mm) thick surfaces with clear space below.
- **Configuration and quantity of ports cannot be modified in the field.**
- **For use with 120 volt 60 hertz power source only.**
- Requires field installation.
- Specify factory cut hole or field cut hole as required.
- Specify AV cables separately.
- Cable Bay requires cables less than 0.3"(8mm) diameter.
- Application may require approval of local authority having jurisdiction (AHJ); ensure compliance before placing orders and installation.

To Order, Specify:

- 1) Product number.
- 2) Finish color for Bezel/Port.

TR-PM1	Silver/White
TR-PM2	Midnight Black/Black
TR-PM8	Matte White/White
TR-PM9	Matte Grey/Black

Note: Order flip top units to match flip top unit cutout option specified for each top (A/B, F/V or J/K).

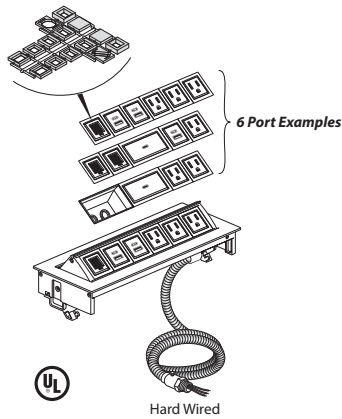

EUC1-HFOP-311010

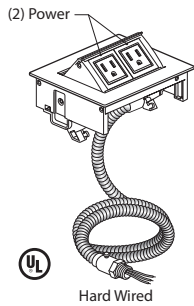

EUC1-HFOP-200000

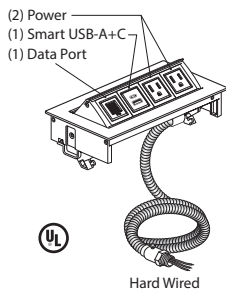

EUC1-HFOP-210010

Class YA – GSA: Open Market

Worksurface Power Modules — Flip Top

Smooth Bezel — Hardwire — Single-Sided

Bezel Depth	Bezel Width	Cord Length	Port	Configuration	Cutout Code	Options	Number	Price
		6'(1829mm)	2	1 Receptacle, 1 Data Port	A, B		EUC1-HFOP-100010	\$ 822.62
				1 Receptacle, 1 Smart USB-A+C Charging	A, B		EUC1-HFOP-101000	926.14
				2 Receptacles	A, B		EUC1-HFOP-200000	822.62
			4	1 Receptacle, 2 Smart USB-A+C Charging, 1 Data Port	F, V		EUC1-HFOP-111010	\$1058.40
				1 Receptacle, 1 Smart USB-A+C Charging, 1 Cable Bay	F, V		EUC1-HFOP-101001	954.88
				1 Receptacle, 1 USB-C 60W Charging, 1 Data Port	F, V		EUC1-HFOP-100110	1210.62
				2 Receptacles, 1 Cable Bay	F, V		EUC1-HFOP-200001	851.36
				2 Receptacles, 1 USB-C 60W Charging	F, V		EUC1-HFOP-200100	1210.62
				2 Receptacles, 1 Smart USB-A+C Charging, 1 Data Port	F, V		EUC1-HFOP-201010	954.88
				2 Receptacles, 2 Data Ports	F, V		EUC1-HFOP-200020	851.36
				2 Receptacles, 2 Smart USB-A+C Charging	F, V		EUC1-HFOP-202000	1058.40
				3 Receptacles, 1 Data Port	F, V		EUC1-HFOP-300010	851.36
				3 Receptacles, 1 Smart USB-A+C Charging	F, V		EUC1-HFOP-301000	954.88
				4 Receptacles	F, V		EUC1-HFOP-400000	851.36
			6	1 Receptacle, 2 Smart USB-A+C Charging, 1 Data Port, 1 Cable Bay	J, K		EUC1-HFOP-111011	\$1072.77
				1 Receptacle, 1 USB-C 60W Charging, 2 Data Ports	J, K		EUC1-HFOP-110120	1328.51
				1 Receptacle, 1 Smart USB-A+C Charging, 2 Data Ports, 1 Cable Bay	J, K		EUC1-HFOP-101021	969.25
				1 Receptacle, 1 USB-C 60W Charging, 1 Data Port, 1 Cable Bay	J, K		EUC1-HFOP-100111	1224.99
				2 Receptacles, 2 Smart USB-A+C Charging, 1 Cable Bay	J, K		EUC1-HFOP-211001	1072.77
				2 Receptacles, 2 Smart USB-A+C Charging, 2 Data Ports	J, K		EUC1-HFOP-211020	1072.77
				2 Receptacles, 1 Smart USB-A+C Charging, 3 Data Ports	J, K		EUC1-HFOP-201030	969.25
				2 Receptacles, 1 USB-C 60W Charging, 1 Cable Bay	J, K		EUC1-HFOP-200101	1224.99
				2 Receptacles, 1 USB-C 60W Charging, 2 Data Ports	J, K		EUC1-HFOP-200120	1224.99
				2 Receptacles, 2 Data Ports, 1 Cable Bay	J, K		EUC1-HFOP-200021	865.73
				2 Receptacles, 4 Data Ports	J, K		EUC1-HFOP-200040	865.73
				3 Receptacles, 1 Data Port, 1 Cable Bay	J, K		EUC1-HFOP-300011	865.73
				3 Receptacles, 2 Smart USB-A+C Charging, 1 Data Port	J, K		EUC1-HFOP-311010	1072.77
				3 Receptacles, 1 Smart USB-A+C Charging, 1 Cable Bay	J, K		EUC1-HFOP-301001	969.25
				3 Receptacles, 1 Smart USB-A+C Charging, 2 Data Ports	J, K		EUC1-HFOP-301020	969.25
				3 Receptacles, 1 USB-C 60W Charging, 1 Data Port	J, K		EUC1-HFOP-300110	1224.99
				3 Receptacles, 3 Data Ports	J, K		EUC1-HFOP-300030	865.73
				4 Receptacles, 2 Smart USB-A+C Charging	J, K		EUC1-HFOP-402000	1072.77
				4 Receptacles, 1 Cable Bay	J, K		EUC1-HFOP-400001	865.73
				4 Receptacles, 1 Smart USB-A+C Charging, 1 Data Port	J, K		EUC1-HFOP-401010	969.25
				4 Receptacles, 1 USB-C 60W Charging	J, K		EUC1-HFOP-400100	1224.99
				4 Receptacles, 2 Data Ports	J, K		EUC1-HFOP-400020	865.73
				5 Receptacles, 1 Data Port	J, K		EUC1-HFOP-500010	865.73
				5 Receptacles, 1 Smart USB-A+C Charging	J, K		EUC1-HFOP-501000	969.25
				6 Receptacles	J, K		EUC1-HFOP-600000	865.73

Worksurface Power Modules — Flip Top

Smooth Bezel — Hardwire — Single-Sided

Bezel Depth	Bezel Width	Cord Length	Port	Configuration	Cutout Code Options	Number	Price
		10'(3048mm)	2	1 Receptacle, 1 Data Port	A, B	EUC1-HJOP-100010	\$ 893.11
				1 Receptacle, 1 Smart USB-A+C Charging	A, B	EUC1-HJOP-101000	996.63
				2 Receptacles	A, B	EUC1-HJOP-200000	893.11
			4	1 Receptacle, 2 Smart USB-A+C Charging, 1 Data Port	F, V	EUC1-HJOP-111010	\$ 1128.89
				1 Receptacle, 1 Smart USB-A+C Charging, 1 Cable Bay	F, V	EUC1-HJOP-101001	1025.37
				1 Receptacle, 1 USB-C 60W Charging, 1 Data Port	F, V	EUC1-HJOP-100110	1281.11
				2 Receptacles, 1 Cable Bay	F, V	EUC1-HJOP-200001	921.85
				2 Receptacles, 1 Smart USB-A+C Charging, 1 Data Port	F, V	EUC1-HJOP-201010	1025.37
				2 Receptacles, 1 USB-C 60W Charging	F, V	EUC1-HJOP-200100	1281.11
				2 Receptacles, 2 Data Ports	F, V	EUC1-HJOP-200020	921.85
				2 Receptacles, 2 Smart USB-A+C Charging	F, V	EUC1-HJOP-202000	1128.89
				3 Receptacles, 1 Data Port	F, V	EUC1-HJOP-300010	921.85
				3 Receptacles, 1 Smart USB-A+C Charging	F, V	EUC1-HJOP-301000	1025.37
				4 Receptacles	F, V	EUC1-HJOP-400000	921.85
			6	1 Receptacle, 2 Smart USB-A+C Charging, 1 Data Port, 1 Cable Bay	J, K	EUC1-HJOP-111011	\$ 1143.26
				1 Receptacle, 1 USB-C 60W Charging, 2 Data Ports	J, K	EUC1-HJOP-110120	1399.00
				1 Receptacle, 1 Smart USB-A+C Charging, 2 Data Ports, 1 Cable Bay	J, K	EUC1-HJOP-101021	1039.74
				1 Receptacle, 1 USB-C 60W Charging, 1 Data Port, 1 Cable Bay	J, K	EUC1-HJOP-100111	1295.48
				2 Receptacles, 2 Smart USB-A+C Charging, 1 Cable Bay	J, K	EUC1-HJOP-211001	1143.26
				2 Receptacles, 2 Smart USB-A+C Charging, 2 Data Ports	J, K	EUC1-HJOP-211020	1143.26
				2 Receptacles, 1 Smart USB-A+C Charging, 3 Data Ports	J, K	EUC1-HJOP-201030	1039.74
				2 Receptacles, 1 USB-C 60W Charging, 1 Cable Bay	J, K	EUC1-HJOP-200101	1295.48
				2 Receptacles, 1 USB-C 60W Charging, 2 Data Ports	J, K	EUC1-HJOP-200120	1295.48
				2 Receptacles, 2 Data Ports, 1 Cable Bay	J, K	EUC1-HJOP-200021	936.22
				2 Receptacles, 4 Data Ports	J, K	EUC1-HJOP-200040	936.22
				3 Receptacles, 1 Data Port, 1 Cable Bay	J, K	EUC1-HJOP-300011	936.22
				3 Receptacles, 2 Smart USB-A+C Charging, 1 Data Port	J, K	EUC1-HJOP-311010	1143.26
				3 Receptacles, 1 Smart USB-A+C Charging, 1 Cable Bay	J, K	EUC1-HJOP-301001	1039.74
				3 Receptacles, 1 Smart USB-A+C Charging, 2 Data Ports	J, K	EUC1-HJOP-301020	1039.74
				3 Receptacles, 1 USB-C 60W Charging, 1 Data Port	J, K	EUC1-HJOP-300110	1295.48
				3 Receptacles, 3 Data Ports	J, K	EUC1-HJOP-300030	936.22
				4 Receptacles, 1 Cable Bay	J, K	EUC1-HJOP-400001	936.22
				4 Receptacles, 1 Smart USB-A+C Charging, 1 Data Port	J, K	EUC1-HJOP-401010	1039.74
				4 Receptacles, 1 USB-C 60W Charging	J, K	EUC1-HJOP-400100	1295.48
				4 Receptacles, 2 Data Ports	J, K	EUC1-HJOP-400020	936.22
				4 Receptacles, 2 Smart USB-A+C Charging	J, K	EUC1-HJOP-402000	1143.26
				5 Receptacles, 1 Data Port	J, K	EUC1-HJOP-500010	936.22
				5 Receptacles, 1 Smart USB-A+C Charging	J, K	EUC1-HJOP-501000	1039.74
				6 Receptacles	J, K	EUC1-HJOP-600000	936.22

Worksurface Power Modules — Flip Top

Smooth Bezel — Hardwire — Double-Sided

Power, Data and USB

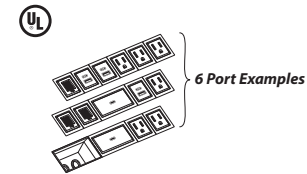
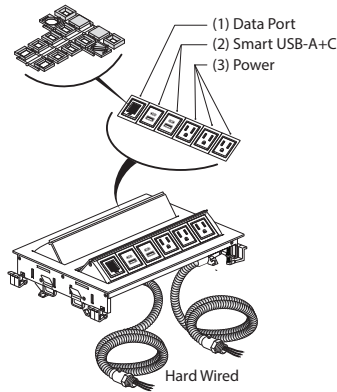

EUC2-HFOP-311010

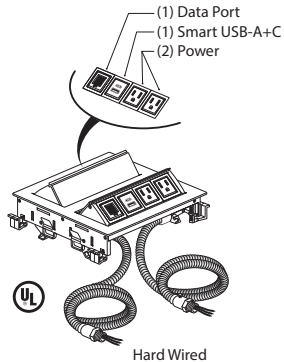

EUC2-HFOP-210010

Class YA – GSA: Open Market

Features

- Includes double flip top with smooth bezel module with 2, 4, or 6 ports configured with simplex outlets (NEMA 5-15R), USB charging port (USB-C 60W, Smart USB-A+C), data port(s) or cable bay, and mounting hardware.
- The Smart USB-A+C allows for the 20W to be transferred between the 2 ports. If the USB-A is being used, the full wattage is sent to the USB-A, and the same for the USB-C. If both are being used, the wattage is distributed to each port and the port drawing the most power will receive more watts than the one that is not.
- Data jack adapters accommodate most varieties of field supplied data jacks or separately specified AV cables. Occupies one port.
- Each cable bay can accept up to two pull out data/AV cables. Occupies two ports.
- USB-A provides two 10W charging ports. Occupies one port.
- Smart USB-A+C can provide fast charge for a mobile phone and tablets. Occupies one charging port.
- USB-C 60W can charge phone, tablets and some laptops. Occupies two ports.
- Smooth bezel is painted and features non mitered corners.
- Port color is either black or white based on smooth bezel color.
- Flip top unit is flush mounted with spring release cover.
- Flip top unit overall height is 2.75”(70mm) and will extend below the table top.
- Each flip top module within the bezel provided with two 6’(1829mm) or 10’(3048mm) long flexible metal conduit feed, 0.5”(13mm) conduit fitting and wires for hardwire connection.
- Ships assembled.

Specification Tips

- Designed to be used with 1.18”(30mm) and 2”(51mm) thick surfaces with clear space below.
- **Configuration and quantity of ports cannot be modified in the field.**
- **For use with 120 volt 60 hertz power source only.**
- Note two conduit feeds are provided from the double-sided flip top unit.
- Requires field installation.
- Specify factory cut hole or field cut hole as required.
- Specify AV cables separately.
- Cable Bay requires cables less than 0.3”(8mm) diameter.
- Application may require approval of local authority having jurisdiction (AHJ); ensure compliance before placing orders and installation.

To Order, Specify:

- 1) Product number.
- 2) Finish color for Bezel/Port.

TR-PM1	Silver/White
TR-PM2	Midnight Black/Black
TR-PM8	Matte White/White
TR-PM9	Matte Grey/Black

Note: Order flip top units to match flip top unit cutout option specified for each top (M/P or Q/V).

Worksurface Power Modules — Flip Top

Smooth Bezel — Hardwire — Double-Sided

Bezel Depth	Bezel Width	Cord Length	Port	Configuration	Cutout Code Options	Number	Price				
6	1829mm		4	1 Receptacle, 2 Smart USB-A+C Charging, 1 Data Port	M, P	EUC2-HFOP-111010	\$ 1933.31				
				1 Receptacle, 1 Smart USB-A+C Charging, 1 Cable Bay	M, P	EUC2-HFOP-101001	1829.79				
				1 Receptacle, 1 USB-C 60W Charging, 1 Data Port	M, P	EUC2-HFOP-100110	2085.53				
				2 Receptacles, 1 USB-C 60W Charging	M, P	EUC2-HFOP-200100	2085.53				
				2 Receptacles, 1 Cable Bay	M, P	EUC2-HFOP-200001	1726.27				
				2 Receptacles, 1 Smart USB-A+C Charging, 1 Data Port	M, P	EUC2-HFOP-201010	1829.79				
				2 Receptacles, 2 Data Ports	M, P	EUC2-HFOP-200020	1726.27				
				2 Receptacles, 2 Smart USB-A+C Charging	M, P	EUC2-HFOP-202000	1933.31				
				3 Receptacles, 1 Data Port	M, P	EUC2-HFOP-300010	1726.27				
				3 Receptacles, 1 Smart USB-A+C Charging	M, P	EUC2-HFOP-301000	1829.79				
				4 Receptacles	M, P	EUC2-HFOP-400000	1726.27				
				6			6	1 Receptacle, 2 Smart USB-A+C Charging, 1 Data Port, 1 Cable Bay	Q, V	EUC2-HFOP-111011	\$ 1990.77
								1 Receptacle, 1 USB-C 60W Charging, 2 Data Ports	Q, V	EUC2-HFOP-110120	2246.51
1 Receptacle, 1 Smart USB-A+C Charging, 2 Data Ports, 1 Cable Bay	Q, V	EUC2-HFOP-101021	1887.25								
1 Receptacle, 1 USB-C 60W Charging, 1 Data Port, 1 Cable Bay	Q, V	EUC2-HFOP-100111	2142.99								
2 Receptacles, 2 Smart USB-A+C Charging, 1 Cable Bay	Q, V	EUC2-HFOP-211001	1990.77								
2 Receptacles, 2 Smart USB-A+C Charging, 2 Data Ports	Q, V	EUC2-HFOP-211020	1990.77								
2 Receptacles, 1 Smart USB-A+C Charging, 3 Data Ports	Q, V	EUC2-HFOP-201030	1887.25								
2 Receptacles, 1 USB-C 60W Charging, 1 Cable Bay	Q, V	EUC2-HFOP-200101	2142.99								
2 Receptacles, 1 USB-C 60W Charging, 2 Data Ports	Q, V	EUC2-HFOP-200120	2142.99								
2 Receptacles, 2 Data Ports, 1 Cable Bay	Q, V	EUC2-HFOP-200021	1783.73								
2 Receptacles, 4 Data Ports	Q, V	EUC2-HFOP-200040	1783.73								
3 Receptacles, 1 Data Port, 1 Cable Bay	Q, V	EUC2-HFOP-300011	1783.73								
3 Receptacles, 2 Smart USB-A+C Charging, 1 Data Port	Q, V	EUC2-HFOP-311010	1990.77								
3 Receptacles, 1 Smart USB-A+C Charging, 1 Cable Bay	Q, V	EUC2-HFOP-301001	1887.25								
3 Receptacles, 1 Smart USB-A+C Charging, 2 Data Ports	Q, V	EUC2-HFOP-301020	1887.25								
3 Receptacles, 1 USB-C 60W Charging, 1 Data Port	Q, V	EUC2-HFOP-300110	2142.99								
3 Receptacles, 3 Data Ports	Q, V	EUC2-HFOP-300030	1783.73								
4 Receptacles, 1 Cable Bay	Q, V	EUC2-HFOP-400001	1783.73								
4 Receptacles, 1 Smart USB-A+C Charging, 1 Data Port	Q, V	EUC2-HFOP-401010	1887.25								
4 Receptacles, 1 USB-C 60W Charging	Q, V	EUC2-HFOP-400100	2142.99								
4 Receptacles, 2 Data Ports	Q, V	EUC2-HFOP-400020	1783.73								
4 Receptacles, 2 Smart USB-A+C Charging	Q, V	EUC2-HFOP-402000	1990.77								
5 Receptacles, 1 Data Port	Q, V	EUC2-HFOP-500010	1783.73								
5 Receptacles, 1 Smart USB-A+C Charging	Q, V	EUC2-HFOP-501000	1887.25								
6 Receptacles	Q, V	EUC2-HFOP-600000	1783.73								

Worksurface Power Modules — Flip Top

Smooth Bezel — Hardwire — Double-Sided

Bezel Depth	Bezel Width	Cord Length	Port	Configuration	Cutout Code Options	Number	Price				
10'(3048mm)			4	1 Receptacle, 2 Smart USB-A+C Charging, 1 Data Port	M, P	EUC2-HJOP-111010	\$2003.80				
				1 Receptacle, 1 Smart USB-A+C Charging, 1 Cable Bay	M, P	EUC2-HJOP-101001	1900.28				
				1 Receptacle, 1 USB-C 60W Charging, 1 Data Port	M, P	EUC2-HJOP-100110	2156.02				
				2 Receptacles, 1 USB-C 60W Charging	M, P	EUC2-HJOP-200100	2156.02				
				2 Receptacles, 1 Cable Bay	M, P	EUC2-HJOP-200001	1796.76				
				2 Receptacles, 1 Smart USB-A+C Charging, 1 Data Port	M, P	EUC2-HJOP-201010	1900.28				
				2 Receptacles, 2 Data Ports	M, P	EUC2-HJOP-200020	1796.76				
				2 Receptacles, 2 Smart USB-A+C Charging	M, P	EUC2-HJOP-202000	2003.80				
				3 Receptacles, 1 Data Port	M, P	EUC2-HJOP-300010	1796.76				
				3 Receptacles, 1 Smart USB-A+C Charging	M, P	EUC2-HJOP-301000	1900.28				
				4 Receptacles	M, P	EUC2-HJOP-400000	1796.76				
				6			6	1 Receptacle, 2 Smart USB-A+C Charging, 1 Data Port, 1 Cable Bay	Q, V	EUC2-HJOP-111011	\$ 2061.26
								1 Receptacle, 1 USB-C 60W Charging, 2 Data Ports	Q, V	EUC2-HJOP-110120	2317.00
								1 Receptacle, 1 Smart USB-A+C Charging, 2 Data Ports, 1 Cable Bay	Q, V	EUC2-HJOP-101021	1957.74
1 Receptacle, 1 USB-C 60W Charging, 1 Data Port, 1 Cable Bay	Q, V	EUC2-HJOP-100111	2213.48								
2 Receptacles, 2 Smart USB-A+C Charging, 1 Cable Bay	Q, V	EUC2-HJOP-211001	2061.26								
2 Receptacles, 2 Smart USB-A+C Charging, 2 Data Ports	Q, V	EUC2-HJOP-211020	2061.26								
2 Receptacles, 1 Smart USB-A+C Charging, 3 Data Ports	Q, V	EUC2-HJOP-201030	1957.74								
2 Receptacles, 1 USB-C 60W Charging, 1 Cable Bay	Q, V	EUC2-HJOP-200101	2213.48								
2 Receptacles, 1 USB-C 60W Charging, 2 Data Ports	Q, V	EUC2-HJOP-200120	2213.48								
2 Receptacles, 2 Data Ports, 1 Cable Bay	Q, V	EUC2-HJOP-200021	1854.22								
2 Receptacles, 4 Data Ports	Q, V	EUC2-HJOP-200040	1854.22								
3 Receptacles, 1 Data Port, 1 Cable Bay	Q, V	EUC2-HJOP-300011	1854.22								
3 Receptacles, 2 Smart USB-A+C Charging, 1 Data Port	Q, V	EUC2-HJOP-311010	2061.26								
3 Receptacles, 1 Smart USB-A+C Charging, 1 Cable Bay	Q, V	EUC2-HJOP-301001	1957.74								
3 Receptacles, 1 Smart USB-A+C Charging, 2 Data Ports	Q, V	EUC2-HJOP-301020	1957.74								
3 Receptacles, 1 USB-C 60W Charging, 1 Data Port	Q, V	EUC2-HJOP-300110	2213.48								
3 Receptacles, 3 Data Ports	Q, V	EUC2-HJOP-300030	1854.22								
4 Receptacles, 1 Cable Bay	Q, V	EUC2-HJOP-400001	1854.22								
4 Receptacles, 1 Smart USB-A+C Charging, 1 Data Port	Q, V	EUC2-HJOP-401010	1957.74								
4 Receptacles, 1 USB-C 60W Charging	Q, V	EUC2-HJOP-400100	2213.48								
4 Receptacles, 2 Smart USB-A+C Charging	Q, V	EUC2-HJOP-402000	2061.26								
5 Receptacles, 1 Data Port	Q, V	EUC2-HJOP-500010	1854.22								
5 Receptacles, 1 Smart USB-A+C Charging	Q, V	EUC2-HJOP-501000	1957.74								
6 Receptacles	Q, V	EUC2-HJOP-600000	1854.22								

Worksurface Power Modules — Flip Top

Power and Data

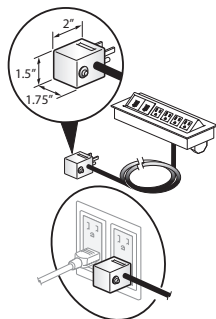
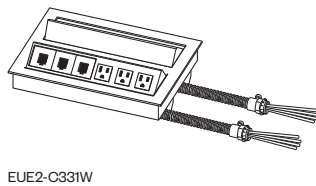
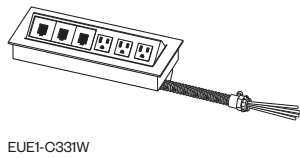
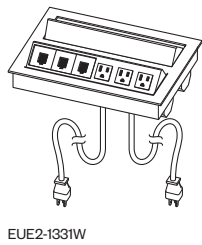
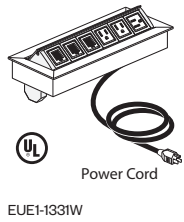
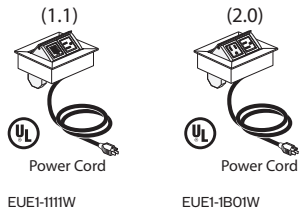

Circuit Breaker Plug Detail
Class YA

Features

- Hardwire flip top unit includes one flip top unit with power outlets and communication openings, mounting clips, 6 foot flexible metal conduit feed with wires for hardwire, multiple data jack adapters to accommodate most varieties of field supplied data jacks, also includes blank data covers.
- Corded flip top unit includes one flip top unit with power outlets and communication openings, 12 foot long – 15-amp cord with plug, mounting clips, multiple data jack adapters to accommodate most varieties of field supplied data jacks, also includes blank data covers.
- Flip top unit is flush mounted with spring release cover.
- Flip top unit overall height is 2.75”(70mm) and will extend below the table tops.
- Standard in anodized finish.
- Ships assembled.

Specification Tips

- Designed to be used with 1.18”(30mm) and 2”(51mm) thick surfaces with clear space below.
- **For use with 120 volt 60 hertz power source only.**
- Flip top unit plug-in cord drops down from bottom of unit to plug into external power outlet.
- Flip top unit must be field installed on worksurfaces by field cutting hole.
- Application may require approval of local authority having jurisdiction (AHJ); ensure compliance before placing orders and installation.

To Order, Specify:

- 1) Product number.
(No finish specification required.)

Bezel Depth	Bezel Width	Configuration	Number	Price
Corded Single-Sided Outlets				
4.37”(111mm)	5.24”(133mm)	1 Power, 1 Data	EUE1-0000-1111W	\$ 629.79
		2 Power, 0 Data	EUE1-0000-1B01W	629.79
4.37”(111mm)	8.31”(211mm)	2 Power, 2 Data	EUE1-0000-1221W	817.10
		3 Power, 1 Data	EUE1-0000-1311W	817.10
	11.25”(286mm)	3 Power, 3 Data	EUE1-0000-1331W	817.10
		4 Power, 2 Data	EUE1-0000-1421W	817.10
Corded Double-Sided Outlets				
8”(203mm)	8.31”(211mm)	2 Power, 2 Data	EUE2-0000-1221W	\$1634.14
		3 Power, 1 Data	EUE2-0000-1311W	1634.14
	11.25”(286mm)	3 Power, 3 Data	EUE2-0000-1331W	1634.14
		4 Power, 2 Data	EUE2-0000-1421W	1634.14
Hardwire Single-Sided Outlets				
4.37”(111mm)	8.31”(211mm)	2 Power, 2 Data	EUE1-0000-C221W	\$ 847.83
		3 Power, 3 Data	EUE1-0000-C331W	847.83
Hardwire Double-Sided Outlets				
8”(203mm)	8.31”(211mm)	2 Power, 2 Data	EUE2-0000-C221W	\$1780.20
		3 Power, 3 Data	EUE2-0000-C331W	1780.20

Worksurface Power Modules — Flip Top

Non-Powered

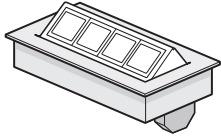

EUE1-000B

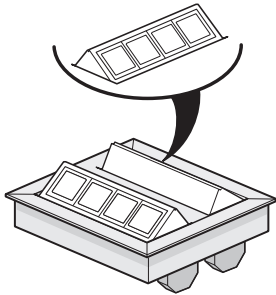

EUE2-000B



Class YA

Features

- Includes bezel and nonpowered flip top module with 2, 4 or 6 ports that can be configured with data ports or cable bays and mounting hardware.
- Data port accommodate most varieties of field supplied data/ AV jacks.
- Each Cable Bay can accept up to 2 pull out data/AV cables
- Flip top unit is flush mounted with spring release flip module(s).
- Flip top unit overall height is 2.75"(70mm) and will extend below the table tops.
- Color option of black anodized housing with black receptacles or clear anodized housing with white receptacles.
- Ships assembled.

Specification Tips

- Designed to be used with 1.18"(30mm) and 2"(51mm)thick surfaces with clear space below.
- **Configuration and quantity of power and data ports cannot be modified in the field.**
- Requires field installation.
- Specify factory cut hole or field cut hole as required.
- Specify AV cables separately.
- Cable Bay requires cables less than 0.3"(8mm) diameter.
- Application may require approval of local authority having jurisdiction (AHJ); ensure compliance before placing orders and installation.

To Order, Specify:

- 1) Product number.
(No finish specification required.)

Bezel Depth	Bezel Width	Trim Color	Port Color	Port	Configuration	Number	Price
Single-Sided Outlets							
4.37"(111mm)	5.32"(135mm)	Black Anodized	Black	2	1 Cable Bay	EUE1-000B-0002	\$ 1102.23
					2 Data Ports	EUE1-000B-0020	1102.23
4.37"(111mm)	8.31"(211mm)			4	2 Data Ports, 1 Cable Bay	EUE1-000B-0022	\$ 1102.23
					4 Data Ports	EUE1-000B-0040	1102.23
4.37"(111mm)	11.3"(287mm)			6	4 Data Ports, 1 Cable Bay	EUE1-000B-0042	\$ 1102.23
					6 Data Ports	EUE1-000B-0060	1102.23
4.37"(111mm)	5.32"(135mm)	Clear Anodized	White	2	1 Cable Bay	EUE1-000W-0002	\$ 822.24
					2 Data Ports	EUE1-000W-0020	822.24
4.37"(111mm)	8.31"(211mm)			4	2 Data Ports, 1 Cable Bay	EUE1-000W-0022	\$ 822.24
					4 Data Ports	EUE1-000W-0040	822.24
4.37"(111mm)	11.3"(287mm)			6	4 Data Ports, 1 Cable Bay	EUE1-000W-0042	\$ 822.24
					6 Data Ports	EUE1-000W-0060	822.24
Double-Sided Outlets							
8.07"(205mm)	8.31"(211mm)	Black Anodized	Black	4	2 Data Ports, 1 Cable Bay	EUE2-000B-0022	\$ 1919.27
					4 Data Ports	EUE2-000B-0040	1919.27
8.07"(205mm)	11.3"(287mm)			6	4 Data Ports, 1 Cable Bay	EUE2-000B-0042	\$ 1919.27
					6 Data Ports	EUE2-000B-0060	1919.27
8.07"(205mm)	8.31"(211mm)	Clear Anodized	White	4	2 Data Ports, 1 Cable Bay	EUE2-000W-0022	\$1639.28
					4 Data Ports	EUE2-000W-0040	1639.28
8.07"(205mm)	11.3"(287mm)			6	4 Data Ports, 1 Cable Bay	EUE2-000W-0042	\$1639.28
					6 Data Ports	EUE2-000W-0060	1639.28

Worksurface Power Modules — Flip Top

Corded – Single-Sided

Power, Data and USB

4-Port:

- (2) Power
- (1) Smart USB-A+C
- (1) Data

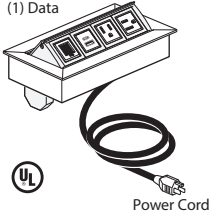

Power Cord

EUE1-PF0B-2110

6-Port:

- (4) Power
- (1) Smart USB-A+C
- (1) Data

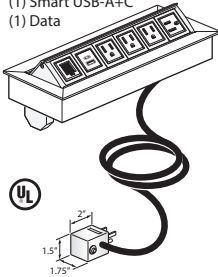

NOTE:
Always Circuit Breaker Plug when more than three power outlets specified.

EUE1-PF0B-1212

4-Port:

- (4) Power

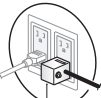
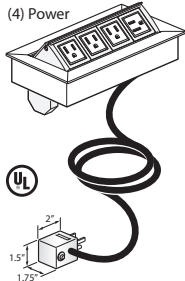

NOTE:
Always Circuit Breaker Plug when more than three power outlets specified.

EUE1-PF0B-4000

Class YA

Features

- Includes bezel and flip top module with 2, 4 or 6 ports that can be configured with simplex outlets (NEMA-5-15R), USB charging port (Smart USB-A+C), data ports or cable bay(s) that can accept up to 2 pull out data/AV cables and mounting hardware.
- Data port accommodate most varieties of field supplied data/ AV jacks.
- Corded power module available with 15 amp - 6'(1829mm) or 12'(3658mm) long cord with plug (NEMA 5-15P).
- The Smart USB-A+C allows for the 20W to be transferred between the 2 ports. If the USB-A is being used, the full wattage is sent to the USB-A, and the same for the USB-C. If both are being used, the wattage is distributed to each port and the port drawing the most power will receive more watts than the one that is not.
- Flip top unit is flush mounted with spring release flip module.
- Flip top unit overall height is 2.75"(70mm) and will extend below the table tops.
- Color option of black anodized housing with black receptacles or clear anodized housing with white receptacles.
- Ships assembled.

Specification Tips

- Designed to be used with 1.18"(30mm) and 2"(51mm) thick surfaces with clear space below.
- **Configuration and quantity of power and data ports cannot be modified in the field.**
- **For use with 120 volt 60 hertz power source only.**
- Requires field installation.
- Specify factory cut hole or field cut hole as required.
- Specify AV cables separately.
- Cable Bay requires cables less than 0.3"(8mm) diameter.
- Application may require approval of local authority having jurisdiction (AHJ); ensure compliance before placing orders and installation.

To Order, Specify:

- 1) Product number.
(No finish specification required.)

Note: Order flip top units to match flip top unit cutout option specified for each top (A/B, F/V or J/K).

Worksurface Power Modules — Flip Top

Corded – Single-Sided

Bezel Depth	Bezel Width	Cord Length	Trim Color	Port Color	Port	Port Configuration	Cutout Code	Options	Number	Price
4.73" (111mm)	5.31" (135mm)	6' (1829mm)	Black Anodized	Black	2	1 Power Receptacle, 1 Data Port	A, B		EUE1-PFOB-1010	\$ 1102.23
						1 Power Receptacle, 1 Smart USB-A+C Charging	A, B		EUE1-PFOB-1100	1205.75
						2 Power Receptacles	A, B		EUE1-PFOB-2000	1102.23
4.37" (111mm)	8.31" (211mm)				4	1 Power Receptacle, 1 Data Port, 1 Cable Bay	F, V		EUE1-PFOB-1012	\$ 1102.23
						1 Power Receptacle, 3 Data Ports	F, V		EUE1-PFOB-1030	1102.23
						1 Power Receptacle, 1 Smart USB-A+C Charging, 1 Cable Bay	F, V		EUE1-PFOB-1102	1205.75
						1 Power Receptacle, 1 Smart USB-A+C Charging, 2 Data Ports	F, V		EUE1-PFOB-1120	1205.75
						1 Power Receptacle, 3 Smart USB-A+C Charging	F, V		EUE1-PFOB-1300	1412.79
						2 Power Receptacles, 1 Cable Bay	F, V		EUE1-PFOB-2002	1102.23
						2 Power Receptacles, 2 Data Ports	F, V		EUE1-PFOB-2020	1102.23
						2 Power Receptacles, 1 Smart USB-A+C Charging, 1 Data Port	F, V		EUE1-PFOB-2110	1205.75
						2 Power Receptacles, 2 Smart USB-A+C Charging	F, V		EUE1-PFOB-2200	1309.27
						3 Power Receptacles, 1 Data Port	F, V		EUE1-PFOB-3010	1102.23
						3 Power Receptacles, 1 Smart USB-A+C Charging	F, V		EUE1-PFOB-3100	1205.75
						4 Power Receptacles	F, V		EUE1-PFOB-4000	1102.23
						4.37" (111mm)	11.3" (287mm)			
1 Power Receptacle, 5 Data Ports	J, K		EUE1-PFOB-1050	1102.23						
1 Power Receptacle, 1 Smart USB-A+C Charging, 2 Data Ports, 1 Cable Bay	J, K		EUE1-PFOB-1122	1205.75						
1 Power Receptacle, 1 Smart USB-A+C Charging, 4 Data Ports	J, K		EUE1-PFOB-1140	1205.75						
1 Power Receptacle, 2 Smart USB-A+C Charging, 1 Data Port, 1 Cable Bay	J, K		EUE1-PFOB-1212	1309.27						
1 Power Receptacle, 2 Smart USB-A+C Charging, 3 Data Ports	J, K		EUE1-PFOB-1230	1309.27						
1 Power Receptacle, 3 Smart USB-A+C Charging, 1 Cable Bay	J, K		EUE1-PFOB-1302	1412.79						
1 Power Receptacle, 3 Smart USB-A+C Charging, 2 Data Ports	J, K		EUE1-PFOB-1320	1412.79						
2 Power Receptacles, 2 Data Ports, 1 Cable Bay	J, K		EUE1-PFOB-2022	1102.23						
2 Power Receptacles, 4 Data Ports	J, K		EUE1-PFOB-2040	1102.23						
2 Power Receptacles, 1 Smart USB-A+C Charging, 1 Data Port, 1 Cable Bay	J, K		EUE1-PFOB-2112	1205.75						
2 Power Receptacles, 1 Smart USB-A+C Charging, 3 Data Ports	J, K		EUE1-PFOB-2130	1205.75						
2 Power Receptacles, 2 Smart USB-A+C Charging, 1 Cable Bay	J, K		EUE1-PFOB-2202	1309.27						
2 Power Receptacles, 2 Smart USB-A+C Charging, 2 Data Ports	J, K		EUE1-PFOB-2220	1309.27						
2 Power Receptacles, 3 Smart USB-A+C Charging, 1 Data Port	J, K		EUE1-PFOB-2310	1412.79						
2 Power Receptacles, 4 Smart USB-A+C Charging	J, K		EUE1-PFOB-2400	1516.31						
3 Power Receptacles, 1 Data Port, 1 Cable Bay	J, K		EUE1-PFOB-3012	1102.23						
3 Power Receptacles, 3 Data Ports	J, K		EUE1-PFOB-3030	1102.23						
3 Power Receptacles, 1 Smart USB-A+C Charging, 1 Cable Bay	J, K		EUE1-PFOB-3102	1205.75						
3 Power Receptacles, 1 Smart USB-A+C Charging, 2 Data Ports	J, K		EUE1-PFOB-3120	1205.75						
3 Power Receptacles, 2 Smart USB-A+C Charging, 1 Data Port	J, K		EUE1-PFOB-3210	1309.27						
3 Power Receptacles, 3 Smart USB-A+C Charging	J, K		EUE1-PFOB-3300	1412.79						
4 Power Receptacles, 1 Cable Bay	J, K		EUE1-PFOB-4002	1102.23						
4 Power Receptacles, 2 Data Ports	J, K		EUE1-PFOB-4020	1102.23						
4 Power Receptacles, 1 Smart USB-A+C Charging, 1 Data Port	J, K		EUE1-PFOB-4110	1205.75						
4 Power Receptacles, 2 Smart USB-A+C Charging	J, K		EUE1-PFOB-4200	1309.27						
5 Power Receptacles, 1 Data Port	J, K		EUE1-PFOB-5010	1102.23						
5 Power Receptacles, 1 Smart USB-A+C Charging	J, K		EUE1-PFOB-5100	1205.75						
6 Power Receptacles	J, K		EUE1-PFOB-6000	1102.23						

Worksurface Power Modules — Flip Top

Corded – Single-Sided

Bezel Depth	Bezel Width	Cord Length	Trim Color	Port Color	Port	Port Configuration	Cutout	Number	Price						
							Code								
							Options								
4.37" (111mm)	5.31" (135mm)	6' (1829mm)	Clear Anodized	White	2	1 Power Receptacle, 1 Data Port	A, B	EUE1-PFOW-1010	\$ 822.24						
						1 Power Receptacle, 1 Smart USB-A+C Charging	A, B	EUE1-PFOW-1100	925.76						
						2 Power Receptacles	A, B	EUE1-PFOW-2000	822.24						
4.37" (111mm)	8.31" (211mm)				4	1 Power Receptacle, 1 Data Port, 1 Cable Bay	F, V	EUE1-PFOW-1012	\$ 822.24						
						1 Power Receptacle, 3 Data Ports	F, V	EUE1-PFOW-1030	822.24						
						1 Power Receptacle, 1 Smart USB-A+C Charging, 1 Cable Bay	F, V	EUE1-PFOW-1102	925.76						
						1 Power Receptacle, 1 Smart USB-A+C Charging, 2 Data Ports	F, V	EUE1-PFOW-1120	925.76						
						1 Power Receptacle, 3 Smart USB-A+C Charging	F, V	EUE1-PFOW-1300	1132.80						
						2 Power Receptacles, 1 Cable Bay	F, V	EUE1-PFOW-2002	822.24						
						2 Power Receptacles, 2 Data Ports	F, V	EUE1-PFOW-2020	822.24						
						2 Power Receptacles, 1 Smart USB-A+C Charging, 1 Data Port	F, V	EUE1-PFOW-2110	925.76						
						2 Power Receptacles, 2 Smart USB-A+C Charging	F, V	EUE1-PFOW-2200	1029.28						
						3 Power Receptacles, 1 Data Port	F, V	EUE1-PFOW-3010	822.24						
						3 Power Receptacles, 1 Smart USB-A+C Charging	F, V	EUE1-PFOW-3100	925.76						
						4 Power Receptacles	F, V	EUE1-PFOW-4000	822.24						
						4.37" (111mm)	11.3" (287mm)				6	1 Power Receptacle, 3 Data Ports, 1 Cable Bay	J, K	EUE1-PFOW-1032	\$ 822.24
												1 Power Receptacle, 5 Data Ports	J, K	EUE1-PFOW-1050	822.24
1 Power Receptacle, 1 Smart USB-A+C Charging, 2 Data Ports, 1 Cable Bay	J, K	EUE1-PFOW-1122	925.76												
1 Power Receptacle, 1 Smart USB-A+C Charging, 4 Data Ports	J, K	EUE1-PFOW-1140	925.76												
1 Power Receptacle, 2 Smart USB-A+C Charging, 1 Data Port, 1 Cable Bay	J, K	EUE1-PFOW-1212	1029.28												
1 Power Receptacle, 2 Smart USB-A+C Charging, 3 Data Ports	J, K	EUE1-PFOW-1230	1029.28												
1 Power Receptacle, 3 Smart USB-A+C Charging, 1 Cable Bay	J, K	EUE1-PFOW-1302	1132.80												
1 Power Receptacle, 3 Smart USB-A+C Charging, 2 Data Ports	J, K	EUE1-PFOW-1320	1132.80												
2 Power Receptacles, 2 Data Ports, 1 Cable Bay	J, K	EUE1-PFOW-2022	822.24												
2 Power Receptacles, 4 Data Ports	J, K	EUE1-PFOW-2040	822.24												
2 Power Receptacles, 1 Smart USB-A+C Charging, 1 Data Port, 1 Cable Bay	J, K	EUE1-PFOW-2112	925.76												
2 Power Receptacles, 1 Smart USB-A+C Charging, 3 Data Ports	J, K	EUE1-PFOW-2130	925.76												
2 Power Receptacles, 2 Smart USB-A+C Charging, 1 Cable Bay	J, K	EUE1-PFOW-2202	1029.28												
2 Power Receptacles, 2 Smart USB-A+C Charging, 2 Data Ports	J, K	EUE1-PFOW-2220	1029.28												
2 Power Receptacles, 3 Smart USB-A+C Charging, 1 Data Port	J, K	EUE1-PFOW-2310	1132.80												
2 Power Receptacles, 4 Smart USB-A+C Charging	J, K	EUE1-PFOW-2400	1236.32												
3 Power Receptacles, 1 Data Port, 1 Cable Bay	J, K	EUE1-PFOW-3012	822.24												
3 Power Receptacles, 3 Data Ports	J, K	EUE1-PFOW-3030	822.24												
3 Power Receptacles, 1 Smart USB-A+C Charging, 1 Cable Bay	J, K	EUE1-PFOW-3102	925.76												
3 Power Receptacles, 1 Smart USB-A+C Charging, 2 Data Ports	J, K	EUE1-PFOW-3120	925.76												
3 Power Receptacles, 2 Smart USB-A+C Charging, 1 Data Port	J, K	EUE1-PFOW-3210	1029.28												
3 Power Receptacles, 3 Smart USB-A+C Charging	J, K	EUE1-PFOW-3300	1132.80												
4 Power Receptacles, 1 Cable Bay	J, K	EUE1-PFOW-4002	822.24												
4 Power Receptacles, 2 Data Ports	J, K	EUE1-PFOW-4020	822.24												
4 Power Receptacles, 1 Smart USB-A+C Charging, 1 Data Port	J, K	EUE1-PFOW-4110	925.76												
4 Power Receptacles, 2 Smart USB-A+C Charging	J, K	EUE1-PFOW-4200	1029.28												
5 Power Receptacles, 1 Data Port	J, K	EUE1-PFOW-5010	822.24												
5 Power Receptacles, 1 Smart USB-A+C Charging	J, K	EUE1-PFOW-5100	925.76												
6 Power Receptacles	J, K	EUE1-PFOW-6000	822.24												

Worksurface Power Modules — Flip Top

Corded – Single-Sided

Bezel Depth	Bezel Width	Cord Length	Trim Color	Port Color	Port	Port Configuration	Cutout	Number	Price
							Code Options		
4.37" (111mm)	5.31" (135mm)	12'	Black Anodized	Black	2	1 Power Receptacle, 1 Data Port	A, B	EUE1-PL0B-1010	\$ 1186.83
						1 Power Receptacle, 1 Smart USB-A+C Charging	A, B	EUE1-PL0B-1100	1290.35
						2 Power Receptacles	A, B	EUE1-PL0B-2000	1186.83
4.37" (111mm)	8.31" (211mm)				4	1 Power Receptacle, 1 Data Port, 1 Cable Bay	F, V	EUE1-PL0B-1012	\$ 1186.83
						1 Power Receptacle, 3 Data Ports	F, V	EUE1-PL0B-1030	1186.83
						1 Power Receptacle, 1 Smart USB-A+C Charging, 1 Cable Bay	F, V	EUE1-PL0B-1102	1290.35
						1 Power Receptacle, 1 Smart USB-A+C Charging, 2 Data Ports	F, V	EUE1-PL0B-1120	1290.35
						1 Power Receptacle, 3 Smart USB-A+C Charging	F, V	EUE1-PL0B-1300	1497.39
						2 Power Receptacles, 1 Cable Bay	F, V	EUE1-PL0B-2002	1186.83
						2 Power Receptacles, 2 Data Ports	F, V	EUE1-PL0B-2020	1186.83
						2 Power Receptacles, 1 Smart USB-A+C Charging, 1 Data Port	F, V	EUE1-PL0B-2110	1290.35
						2 Power Receptacles, 2 Smart USB-A+C Charging	F, V	EUE1-PL0B-2200	1393.87
						3 Power Receptacles, 1 Data Port	F, V	EUE1-PL0B-3010	1186.83
						3 Power Receptacles, 1 Smart USB-A+C Charging	F, V	EUE1-PL0B-3100	1290.35
						4 Power Receptacles	F, V	EUE1-PL0B-4000	1186.83
						4.37" (111mm)	11.3" (287mm)		
1 Power Receptacle, 5 Data Ports	J, K	EUE1-PL0B-1050	1186.83						
1 Power Receptacle, 1 Smart USB-A+C Charging, 2 Data Ports, 1 Cable Bay	J, K	EUE1-PL0B-1122	1290.35						
1 Power Receptacle, 1 Smart USB-A+C Charging, 4 Data Ports	J, K	EUE1-PL0B-1140	1290.35						
1 Power Receptacle, 2 Smart USB-A+C Charging, 1 Data Port, 1 Cable Bay	J, K	EUE1-PL0B-1212	1393.87						
1 Power Receptacle, 2 Smart USB-A+C Charging, 3 Data Ports	J, K	EUE1-PL0B-1230	1393.87						
1 Power Receptacle, 3 Smart USB-A+C Charging, 1 Cable Bay	J, K	EUE1-PL0B-1302	1497.39						
1 Power Receptacle, 3 Smart USB-A+C Charging, 2 Data Ports	J, K	EUE1-PL0B-1320	1497.39						
2 Power Receptacles, 2 Data Ports, 1 Cable Bay	J, K	EUE1-PL0B-2022	1186.83						
2 Power Receptacles, 4 Data Ports	J, K	EUE1-PL0B-2040	1186.83						
2 Power Receptacles, 1 Smart USB-A+C Charging, 1 Data Port, 1 Cable Bay	J, K	EUE1-PL0B-2112	1290.35						
2 Power Receptacles, 1 Smart USB-A+C Charging, 3 Data Ports	J, K	EUE1-PL0B-2130	1290.35						
2 Power Receptacles, 2 Smart USB-A+C Charging, 1 Cable Bay	J, K	EUE1-PL0B-2202	1393.87						
2 Power Receptacles, 2 Smart USB-A+C Charging, 2 Data Ports	J, K	EUE1-PL0B-2220	1393.87						
2 Power Receptacles, 3 Smart USB-A+C Charging, 1 Data Port	J, K	EUE1-PL0B-2310	1497.39						
2 Power Receptacles, 4 Smart USB-A+C Charging	J, K	EUE1-PL0B-2400	1600.91						
3 Power Receptacles, 1 Data Port, 1 Cable Bay	J, K	EUE1-PL0B-3012	1186.83						
3 Power Receptacles, 3 Data Ports	J, K	EUE1-PL0B-3030	1186.83						
3 Power Receptacles, 1 Smart USB-A+C Charging, 1 Cable Bay	J, K	EUE1-PL0B-3102	1290.35						
3 Power Receptacles, 1 Smart USB-A+C Charging, 2 Data Ports	J, K	EUE1-PL0B-3120	1290.35						
3 Power Receptacles, 2 Smart USB-A+C Charging, 1 Data Port	J, K	EUE1-PL0B-3210	1393.87						
3 Power Receptacles, 3 Smart USB-A+C Charging	J, K	EUE1-PL0B-3300	1497.39						
4 Power Receptacles, 1 Cable Bay	J, K	EUE1-PL0B-4002	1186.83						
4 Power Receptacles, 2 Data Ports	J, K	EUE1-PL0B-4020	1186.83						
4 Power Receptacles, 1 Smart USB-A+C Charging, 1 Data Port	J, K	EUE1-PL0B-4110	1290.35						
4 Power Receptacles, 2 Smart USB-A+C Charging	J, K	EUE1-PL0B-4200	1393.87						
5 Power Receptacles, 1 Data Port	J, K	EUE1-PL0B-5010	1186.83						
5 Power Receptacles, 1 Smart USB-A+C Charging	J, K	EUE1-PL0B-5100	1290.35						
6 Power Receptacles	J, K	EUE1-PL0B-6000	1186.83						

Worksurface Power Modules — Flip Top

Corded – Single-Sided

Bezel Depth	Bezel Width	Cord Length	Trim Color	Port Color	Port	Port Configuration	Cutout		Price
							Code	Options Number	
4.37" (111mm)	5.31" (135mm)	12'	Clear Anodized	White	2	1 Power Receptacle, 1 Data Port	A, B	EUE1-PLow-1010	\$ 906.84
						1 Power Receptacle, 1 Smart USB-A+C Charging	A, B	EUE1-PLow-1100	1010.36
						2 Power Receptacles	A, B	EUE1-PLow-2000	906.84
4.37" (111mm)	8.31" (211mm)				4	1 Power Receptacle, 1 Data Port, 1 Cable Bay	F, V	EUE1-PLow-1012	\$ 906.84
						1 Power Receptacle, 3 Data Ports	F, V	EUE1-PLow-1030	906.84
						1 Power Receptacle, 1 Smart USB-A+C Charging, 1 Cable Bay	F, V	EUE1-PLow-1102	1010.36
						1 Power Receptacle, 1 Smart USB-A+C Charging, 2 Data Ports	F, V	EUE1-PLow-1120	1010.36
						1 Power Receptacle, 3 Smart USB-A+C Charging	F, V	EUE1-PLow-1300	1217.40
						2 Power Receptacles, 1 Cable Bay	F, V	EUE1-PLow-2002	906.84
						2 Power Receptacles, 2 Data Ports	F, V	EUE1-PLow-2020	906.84
						2 Power Receptacles, 1 Smart USB-A+C Charging, 1 Data Port	F, V	EUE1-PLow-2110	1010.36
						2 Power Receptacles, 2 Smart USB-A+C Charging	F, V	EUE1-PLow-2200	1113.88
						3 Power Receptacles, 1 Data Port	F, V	EUE1-PLow-3010	906.84
						3 Power Receptacles, 1 Smart USB-A+C Charging	F, V	EUE1-PLow-3100	1010.36
						4 Power Receptacles	F, V	EUE1-PLow-4000	906.84
						4.37" (111mm)	11.3" (287mm)		
1 Power Receptacle, 5 Data Ports	J, K	EUE1-PLow-1050	906.84						
1 Power Receptacle, 1 Smart USB-A+C Charging, 2 Data Ports, 1 Cable Bay	J, K	EUE1-PLow-1122	1010.36						
1 Power Receptacle, 1 Smart USB-A+C Charging, 4 Data Ports	J, K	EUE1-PLow-1140	1010.36						
1 Power Receptacle, 2 Smart USB-A+C Charging, 1 Data Port, 1 Cable Bay	J, K	EUE1-PLow-1212	1113.88						
1 Power Receptacle, 2 Smart USB-A+C Charging, 3 Data Ports	J, K	EUE1-PLow-1230	1113.88						
1 Power Receptacle, 3 Smart USB-A+C Charging, 1 Cable Bay	J, K	EUE1-PLow-1302	1217.40						
1 Power Receptacle, 3 Smart USB-A+C Charging, 2 Data Ports	J, K	EUE1-PLow-1320	1217.40						
2 Power Receptacles, 2 Data Ports, 1 Cable Bay	J, K	EUE1-PLow-2022	906.84						
2 Power Receptacles, 4 Data Ports	J, K	EUE1-PLow-2040	906.84						
2 Power Receptacles, 1 Smart USB-A+C Charging, 1 Data Port, 1 Cable Bay	J, K	EUE1-PLow-2112	1010.36						
2 Power Receptacles, 1 Smart USB-A+C Charging, 3 Data Ports	J, K	EUE1-PLow-2130	1010.36						
2 Power Receptacles, 2 Smart USB-A+C Charging, 1 Cable Bay	J, K	EUE1-PLow-2202	1113.88						
2 Power Receptacles, 2 Smart USB-A+C Charging, 2 Data Ports	J, K	EUE1-PLow-2220	1113.88						
2 Power Receptacles, 3 Smart USB-A+C Charging, 1 Data Port	J, K	EUE1-PLow-2310	1217.40						
2 Power Receptacles, 4 Smart USB-A+C Charging	J, K	EUE1-PLow-2400	1320.92						
3 Power Receptacles, 1 Data Port, 1 Cable Bay	J, K	EUE1-PLow-3012	906.84						
3 Power Receptacles, 3 Data Ports	J, K	EUE1-PLow-3030	906.84						
3 Power Receptacles, 1 Smart USB-A+C Charging, 1 Cable Bay	J, K	EUE1-PLow-3102	1010.36						
3 Power Receptacles, 1 Smart USB-A+C Charging, 2 Data Ports	J, K	EUE1-PLow-3120	1010.36						
3 Power Receptacles, 2 Smart USB-A+C Charging, 1 Data Port	J, K	EUE1-PLow-3210	1113.88						
3 Power Receptacles, 3 Smart USB-A+C Charging	J, K	EUE1-PLow-3300	1217.40						
4 Power Receptacles, 1 Cable Bay	J, K	EUE1-PLow-4002	906.84						
4 Power Receptacles, 2 Data Ports	J, K	EUE1-PLow-4020	906.84						
4 Power Receptacles, 1 Smart USB-A+C Charging, 1 Data Port	J, K	EUE1-PLow-4110	1010.36						
4 Power Receptacles, 2 Smart USB-A+C Charging	J, K	EUE1-PLow-4200	1113.88						
5 Power Receptacles, 1 Data Port	J, K	EUE1-PLow-5010	906.84						
5 Power Receptacles, 1 Smart USB-A+C Charging	J, K	EUE1-PLow-5100	1010.36						
6 Power Receptacles	J, K	EUE1-PLow-6000	906.84						

Worksurface Power Modules — Flip Top

Corded — Double-Sided

Power, Data and USB

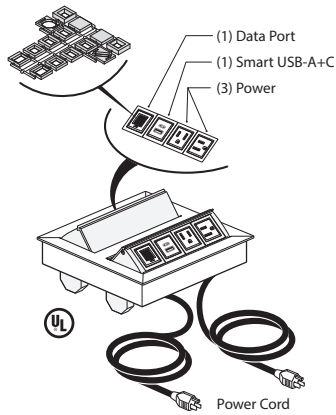

EUE2-PFOB-2110

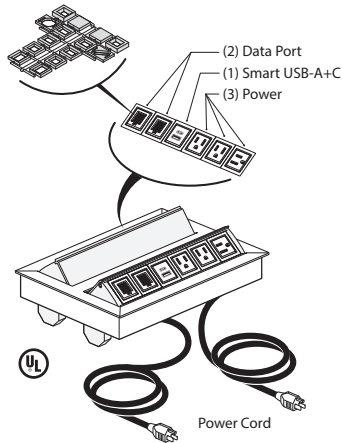

EUE2-PFOB-1212

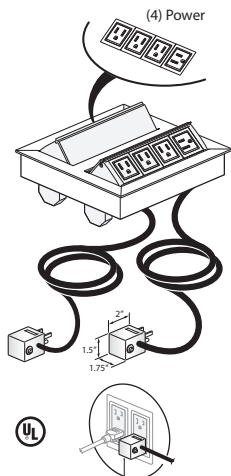

EUE2-PFOB-4000

Class YA

Features

- Includes bezel and two flip top modules, each flip top module with 2, 4 or 6 ports that can be configured with simplex outlets (NEMA-5-15R), USB charging port (Smart USB-A+C) data ports or cable bay(s) that can accept up to 2 pull out data/AV cables and mounting hardware.
- Data port accommodate most varieties of field supplied data/ AV jacks.
- Each flip top module within the bezel provided with 15 amp - 6' (1829mm) or 12' (3658mm) long cord with plug (NEMA5-15P).
- The Smart USB-A+C allows for the 20W to be transferred between the 2 ports. If the USB-A is being used, the full wattage is sent to the USB-A, and the same for the USB-C. If both are being used, the wattage is distributed to each port and the port drawing the most power will receive more watts than the one that is not.
- Flip top unit is flush mounted with spring release flip module.
- Flip top unit overall height is 2.75" (70mm) and will extend below the table tops.
- Color option of black anodized housing with black receptacles or clear anodized housing with white receptacles.
- Ships assembled.

Specification Tips

- Designed to be used with 1.18" (30mm) and 2" (51mm) thick surfaces with clear space below.
 - **Configuration and quantity of power and data ports cannot be modified in the field.**
 - **For use with 120 volt 60 hertz power source only.**
 - Requires field installation.
 - Specify factory cut hole or field cut hole as required.
 - Specify AV cables separately.
 - Cable Bay requires cables less than 0.3" (8mm) diameter.
 - Application may require approval of local authority having jurisdiction (AHJ); ensure compliance before placing orders and installation.
- Two cord feeds are provided from the double-sided flip top unit.

To Order, Specify:

- 1) Product number.
(No finish specification required.)

Note: Order flip top units to match flip top unit cutout option specified for each top (M/P or Q/T).

Worksurface Power Modules — Flip Top

Corded — Double-Sided

Bezel Depth	Bezel Width	Cord Length	Trim Color	Port Color	Port	Port Configuration	Cutout Code	Options	Number	Price	
8" (203mm)	5.31" (135mm)	6' (1829mm)	Black Anodized	Black	4	1 Power Receptacle, 1 Data Port, 1 Cable Bay	M, P		EUE2-PFOB-1012	\$ 1919.27	
						1 Power Receptacle, 3 Data Ports	M, P		EUE2-PFOB-1030	1919.27	
						1 Power Receptacle, 1 Smart USB-A+C Charging, 1 Cable Bay	M, P		EUE2-PFOB-1102	2022.79	
						1 Power Receptacle, 1 Smart USB-A+C Charging, 2 Data Ports	M, P		EUE2-PFOB-1120	2022.79	
						1 Power Receptacle, 3 Smart USB-A+C Charging	M, P		EUE2-PFOB-1300	2229.83	
						2 Power Receptacles, 1 Cable Bay	M, P		EUE2-PFOB-2002	1919.27	
						2 Power Receptacles, 2 Data Ports	M, P		EUE2-PFOB-2020	1919.27	
						2 Power Receptacles, 1 Smart USB-A+C Charging, 1 Data Port	M, P		EUE2-PFOB-2110	2022.79	
						2 Power Receptacles, 2 Smart USB-A+C Charging	M, P		EUE2-PFOB-2200	2126.31	
						3 Power Receptacles, 1 Data Port	M, P		EUE2-PFOB-3010	1919.27	
						3 Power Receptacles, 1 Smart USB-A+C Charging	M, P		EUE2-PFOB-3100	2022.79	
						4 Power Receptacles	M, P		EUE2-PFOB-4000	1919.27	
						6	1 Power Receptacle, 3 Data Ports, 1 Cable Bay	Q, T		EUE2-PFOB-1032	\$ 1919.27
							1 Power Receptacle, 5 Data Ports	Q, T		EUE2-PFOB-1050	1919.27
							1 Power Receptacle, 1 Smart USB-A+C Charging, 2 Data Ports, 1 Cable Bay	Q, T		EUE2-PFOB-1122	2022.79
					1 Power Receptacle, 1 Smart USB-A+C Charging, 4 Data Ports		Q, T		EUE2-PFOB-1140	2022.79	
					1 Power Receptacle, 2 Smart USB-A+C Charging, 1 Data Port, 1 Cable Bay		Q, T		EUE2-PFOB-1212	2126.31	
					1 Power Receptacle, 2 Smart USB-A+C Charging, 3 Data Ports		Q, T		EUE2-PFOB-1230	2126.31	
					1 Power Receptacle, 3 Smart USB-A+C Charging, 2 Cable Bays		Q, T		EUE2-PFOB-1302	2229.83	
					1 Power Receptacle, 3 Smart USB-A+C Charging, 2 Data Ports		Q, T		EUE2-PFOB-1320	2229.83	
					2 Power Receptacles, 2 Data Ports, 2 Cable Bays		Q, T		EUE2-PFOB-2022	1919.27	
					2 Power Receptacles, 4 Data Ports		Q, T		EUE2-PFOB-2040	1919.27	
					2 Power Receptacles, 1 Smart USB-A+C Charging, 1 Data Port, 2 Cable Bays		Q, T		EUE2-PFOB-2112	2022.79	
					2 Power Receptacles, 1 Smart USB-A+C Charging, 3 Data Ports		Q, T		EUE2-PFOB-2130	2022.79	
					2 Power Receptacles, 2 Smart USB-A+C Charging, 2 Cable Bays		Q, T		EUE2-PFOB-2202	2126.31	
					2 Power Receptacles, 2 Smart USB-A+C Charging, 2 Data Ports		Q, T		EUE2-PFOB-2220	2126.31	
					2 Power Receptacles, 3 Smart USB-A+C Charging, 1 Data Port		Q, T		EUE2-PFOB-2310	2229.83	
					2 Power Receptacles, 4 Smart USB-A+C Charging	Q, T		EUE2-PFOB-2400	2333.35		
					3 Power Receptacles, 1 Data Port, 2 Cable Bays	Q, T		EUE2-PFOB-3012	1919.27		
					3 Power Receptacles, 3 Data Ports	Q, T		EUE2-PFOB-3030	1919.27		
3 Power Receptacles, 1 Smart USB-A+C Charging, 2 Cable Bays	Q, T		EUE2-PFOB-3102	2022.79							
3 Power Receptacles, 1 Smart USB-A+C Charging, 2 Data Ports	Q, T		EUE2-PFOB-3120	2022.79							
3 Power Receptacles, 2 Smart USB-A+C Charging, 1 Data Port	Q, T		EUE2-PFOB-3210	2126.31							
3 Power Receptacles, 3 Smart USB-A+C Charging	Q, T		EUE2-PFOB-3300	2229.83							
4 Power Receptacles, 2 Cable Bays	Q, T		EUE2-PFOB-4002	1919.27							
4 Power Receptacles, 2 Data Ports	Q, T		EUE2-PFOB-4020	1919.27							
4 Power Receptacles, 1 Smart USB-A+C Charging, 1 Data Port	Q, T		EUE2-PFOB-4110	2022.79							
4 Power Receptacles, 2 Smart USB-A+C Charging	Q, T		EUE2-PFOB-4200	2126.31							
5 Power Receptacles, 1 Data Port	Q, T		EUE2-PFOB-5010	1919.27							
5 Power Receptacles, 1 Smart USB-A+C Charging	Q, T		EUE2-PFOB-5100	2022.79							
6 Power Receptacles	Q, T		EUE2-PFOB-6000	1919.27							

Worksurface Power Modules — Flip Top

Corded — Double-Sided

Bezel Depth	Bezel Width	Cord Length	Trim Color	Port Color	Port	Port Configuration	Cutout	Options	Number	Price
							Code			
8" (203mm)	5.31" (135mm)	6' (1829mm)	Clear Anodized	White	4	1 Power Receptacle, 1 Data Port, 1 Cable Bay	M, P	EUE2-PFOW-1012	\$ 1639.28	
						1 Power Receptacle, 3 Data Ports	M, P	EUE2-PFOW-1030	1639.28	
						1 Power Receptacle, 1 Smart USB-A+C Charging, 1 Cable Bay	M, P	EUE2-PFOW-1102	1742.80	
						1 Power Receptacle, 1 Smart USB-A+C Charging, 2 Data Ports	M, P	EUE2-PFOW-1120	1742.80	
						1 Power Receptacle, 3 Smart USB-A+C Charging	M, P	EUE2-PFOW-1300	1949.84	
						2 Power Receptacles, 1 Cable Bay	M, P	EUE2-PFOW-2002	1639.28	
						2 Power Receptacles, 2 Data Ports	M, P	EUE2-PFOW-2020	1639.28	
						2 Power Receptacles, 1 Smart USB-A+C Charging, 1 Data Port	M, P	EUE2-PFOW-2110	1742.80	
						2 Power Receptacles, 2 Smart USB-A+C Charging	M, P	EUE2-PFOW-2200	1846.32	
						3 Power Receptacles, 1 Data Port	M, P	EUE2-PFOW-3010	1639.28	
						3 Power Receptacles, 1 Smart USB-A+C Charging	M, P	EUE2-PFOW-3100	1742.80	
						4 Power Receptacles	M, P	EUE2-PFOW-4000	1639.28	
						6	1 Power Receptacle, 3 Data Ports, 1 Cable Bay	Q, T	EUE2-PFOW-1032	\$ 1639.28
							1 Power Receptacle, 5 Data Ports	Q, T	EUE2-PFOW-1050	1639.28
							1 Power Receptacle, 1 Smart USB-A+C Charging, 2 Data Ports, 1 Cable Bay	Q, T	EUE2-PFOW-1122	1742.80
							1 Power Receptacle, 1 Smart USB-A+C Charging, 4 Data Ports	Q, T	EUE2-PFOW-1140	1742.80
					1 Power Receptacle, 2 Smart USB-A+C Charging, 1 Data Port, 1 Cable Bay		Q, T	EUE2-PFOW-1212	1846.32	
					1 Power Receptacle, 2 Smart USB-A+C Charging, 3 Data Ports		Q, T	EUE2-PFOW-1230	1846.32	
					1 Power Receptacle, 3 Smart USB-A+C Charging, 1 Cable Bay		Q, T	EUE2-PFOW-1302	1949.84	
					1 Power Receptacle, 3 Smart USB-A+C Charging, 2 Data Ports		Q, T	EUE2-PFOW-1320	1949.84	
					2 Power Receptacles, 2 Data Ports, 1 Cable Bay		Q, T	EUE2-PFOW-2022	1639.28	
					2 Power Receptacles, 4 Data Ports		Q, T	EUE2-PFOW-2040	1639.28	
					2 Power Receptacles, 1 Smart USB-A+C Charging, 1 Data Port, 1 Cable Bay		Q, T	EUE2-PFOW-2112	1742.80	
					2 Power Receptacles, 1 Smart USB-A+C Charging, 3 Data Ports		Q, T	EUE2-PFOW-2130	1742.80	
					2 Power Receptacles, 2 Smart USB-A+C Charging, 1 Cable Bay		Q, T	EUE2-PFOW-2202	1846.32	
					2 Power Receptacles, 2 Smart USB-A+C Charging, 2 Data Ports		Q, T	EUE2-PFOW-2220	1846.32	
					2 Power Receptacles, 3 Smart USB-A+C Charging, 1 Data Port		Q, T	EUE2-PFOW-2310	1949.84	
					2 Power Receptacles, 4 Smart USB-A+C Charging		Q, T	EUE2-PFOW-2400	2053.36	
					3 Power Receptacles, 1 Data Port, 1 Cable Bay	Q, T	EUE2-PFOW-3012	1639.28		
					3 Power Receptacles, 3 Data Ports	Q, T	EUE2-PFOW-3030	1639.28		
					3 Power Receptacles, 1 Smart USB-A+C Charging, 1 Cable Bay	Q, T	EUE2-PFOW-3102	1742.80		
					3 Power Receptacles, 1 Smart USB-A+C Charging, 2 Data Ports	Q, T	EUE2-PFOW-3120	1742.80		
3 Power Receptacles, 2 Smart USB-A+C Charging, 1 Data Port	Q, T	EUE2-PFOW-3210	1846.32							
3 Power Receptacles, 3 Smart USB-A+C Charging	Q, T	EUE2-PFOW-3300	1949.84							
4 Power Receptacles, 1 Cable Bay	Q, T	EUE2-PFOW-4002	1639.28							
4 Power Receptacles, 2 Data Ports	Q, T	EUE2-PFOW-4020	1639.28							
4 Power Receptacles, 1 Smart USB-A+C Charging, 1 Data Port	Q, T	EUE2-PFOW-4110	1742.80							
4 Power Receptacles, 2 Smart USB-A+C Charging	Q, T	EUE2-PFOW-4200	1846.32							
5 Power Receptacles, 1 Data Port	Q, T	EUE2-PFOW-5010	1639.28							
5 Power Receptacles, 1 Smart USB-A+C Charging	Q, T	EUE2-PFOW-5100	1742.80							
6 Power Receptacles	Q, T	EUE2-PFOW-6000	1639.28							

Worksurface Power Modules — Flip Top

Corded — Double-Sided

Bezel Depth	Bezel Width	Cord Length	Trim Color	Port Color	Port	Port Configuration	Cutout	Number	Price	
							Code			
							Options			
8" (203mm)	5.31" (135mm)	12' (3658mm)	Black Anodized	Black	4	1 Power Receptacle, 1 Data Port, 1 Cable Bay	M, P	EUE2-PLOB-1012	\$2003.87	
						1 Power Receptacle, 3 Data Ports	M, P	EUE2-PLOB-1030	2003.87	
						1 Power Receptacle, 1 Smart USB-A+C Charging, 1 Cable Bay	M, P	EUE2-PLOB-1102	2107.39	
						1 Power Receptacle, 1 Smart USB-A+C Charging, 2 Data Ports	M, P	EUE2-PLOB-1120	2107.39	
						1 Power Receptacle, 3 Smart USB-A+C Charging	M, P	EUE2-PLOB-1300	2314.43	
						2 Power Receptacles, 1 Cable Bay	M, P	EUE2-PLOB-2002	2003.87	
						2 Power Receptacles, 2 Data Ports	M, P	EUE2-PLOB-2020	2003.87	
						2 Power Receptacles, 1 Smart USB-A+C Charging, 1 Data Port	M, P	EUE2-PLOB-2110	2107.39	
						2 Power Receptacles, 2 Smart USB-A+C Charging	M, P	EUE2-PLOB-2200	2210.91	
						3 Power Receptacles, 1 Data Port	M, P	EUE2-PLOB-3010	2003.87	
						3 Power Receptacles, 1 Smart USB-A+C Charging	M, P	EUE2-PLOB-3100	2107.39	
						4 Power Receptacles	M, P	EUE2-PLOB-4000	2003.87	
						6	1 Power Receptacle, 3 Data Ports, 1 Cable Bay	Q, T	EUE2-PLOB-1032	\$2003.87
							1 Power Receptacle, 5 Data Ports	Q, T	EUE2-PLOB-1050	2003.87
							1 Power Receptacle, 1 Smart USB-A+C Charging, 2 Data Ports, 1 Cable Bay	Q, T	EUE2-PLOB-1122	2107.39
							1 Power Receptacle, 1 Smart USB-A+C Charging, 4 Data Ports	Q, T	EUE2-PLOB-1140	2107.39
					1 Power Receptacle, 2 Smart USB-A+C Charging, 1 Data Port, 1 Cable Bay		Q, T	EUE2-PLOB-1212	2210.91	
					1 Power Receptacle, 2 Smart USB-A+C Charging, 3 Data Ports		Q, T	EUE2-PLOB-1230	2210.91	
					1 Power Receptacle, 3 Smart USB-A+C Charging, 1 Cable Bay		Q, T	EUE2-PLOB-1302	2314.43	
					1 Power Receptacle, 3 Smart USB-A+C Charging, 2 Data Ports		Q, T	EUE2-PLOB-1320	2314.43	
					2 Power Receptacles, 2 Data Ports, 1 Cable Bay		Q, T	EUE2-PLOB-2022	2003.87	
					2 Power Receptacles, 4 Data Ports		Q, T	EUE2-PLOB-2040	2003.87	
					2 Power Receptacles, 1 Smart USB-A+C Charging, 1 Data Port, 1 Cable Bay		Q, T	EUE2-PLOB-2112	2107.39	
					2 Power Receptacles, 1 Smart USB-A+C Charging, 3 Data Ports		Q, T	EUE2-PLOB-2130	2107.39	
					2 Power Receptacles, 2 Smart USB-A+C Charging, 1 Cable Bay		Q, T	EUE2-PLOB-2202	2210.91	
					2 Power Receptacles, 2 Smart USB-A+C Charging, 2 Data Ports		Q, T	EUE2-PLOB-2220	2210.91	
					2 Power Receptacles, 3 Smart USB-A+C Charging, 1 Data Port		Q, T	EUE2-PLOB-2310	2314.43	
					2 Power Receptacles, 4 Smart USB-A+C Charging		Q, T	EUE2-PLOB-2400	2417.95	
					3 Power Receptacles, 1 Data Port, 1 Cable Bay	Q, T	EUE2-PLOB-3012	2003.87		
					3 Power Receptacles, 3 Data Ports	Q, T	EUE2-PLOB-3030	2003.87		
					3 Power Receptacles, 1 Smart USB-A+C Charging, 1 Cable Bay	Q, T	EUE2-PLOB-3102	2107.39		
					3 Power Receptacles, 1 Smart USB-A+C Charging, 2 Data Ports	Q, T	EUE2-PLOB-3120	2107.39		
3 Power Receptacles, 2 Smart USB-A+C Charging, 1 Data Port	Q, T	EUE2-PLOB-3210	2210.91							
3 Power Receptacles, 3 Smart USB-A+C Charging	Q, T	EUE2-PLOB-3300	2314.43							
4 Power Receptacles, 1 Cable Bay	Q, T	EUE2-PLOB-4002	2003.87							
4 Power Receptacles, 2 Data Ports	Q, T	EUE2-PLOB-4020	2003.87							
4 Power Receptacles, 1 Smart USB-A+C Charging, 1 Data Port	Q, T	EUE2-PLOB-4110	2107.39							
4 Power Receptacles, 2 Smart USB-A+C Charging	Q, T	EUE2-PLOB-4200	2210.91							
5 Power Receptacles, 1 Data Port	Q, T	EUE2-PLOB-5010	2003.87							
5 Power Receptacles, 1 Smart USB-A+C Charging	Q, T	EUE2-PLOB-5100	2107.39							
6 Power Receptacles	Q, T	EUE2-PLOB-6000	2003.87							

Worksurface Power Modules — Flip Top

Corded — Double-Sided

Bezel Depth	Bezel Width	Cord Length	Trim Color	Port Color	Port	Port Configuration	Cutout	Number	Price	
							Code			Options
8" (203mm)	5.31" (135mm)	12' (3658mm)	Clear Anodized	White	4	1 Power Receptacle, 1 Data Port, 1 Cable Bay	M, P	EUE2-PLOW-1012	\$ 1723.88	
						1 Power Receptacle, 3 Data Ports	M, P	EUE2-PLOW-1030	1723.88	
						1 Power Receptacle, 1 Smart USB-A+C Charging, 1 Cable Bay	M, P	EUE2-PLOW-1102	1827.40	
						1 Power Receptacle, 1 Smart USB-A+C Charging, 2 Data Ports	M, P	EUE2-PLOW-1120	1827.40	
						1 Power Receptacle, 3 Smart USB-A+C Charging	M, P	EUE2-PLOW-1300	2034.44	
						2 Power Receptacles, 1 Cable Bay	M, P	EUE2-PLOW-2002	1723.88	
						2 Power Receptacles, 2 Data Ports	M, P	EUE2-PLOW-2020	1723.88	
						2 Power Receptacles, 1 Smart USB-A+C Charging, 1 Data Port	M, P	EUE2-PLOW-2110	1827.40	
						2 Power Receptacles, 2 Smart USB-A+C Charging	M, P	EUE2-PLOW-2200	1930.92	
						3 Power Receptacles, 1 Data Port	M, P	EUE2-PLOW-3010	1723.88	
						3 Power Receptacles, 1 Smart USB-A+C Charging	M, P	EUE2-PLOW-3100	1827.40	
						4 Power Receptacles	M, P	EUE2-PLOW-4000	1723.88	
						6	1 Power Receptacle, 3 Data Ports, 1 Cable Bay	Q, T	EUE2-PLOW-1032	\$ 1723.88
							1 Power Receptacle, 5 Data Ports	Q, T	EUE2-PLOW-1050	1723.88
							1 Power Receptacle, 1 Smart USB-A+C Charging, 2 Data Ports, 1 Cable Bay	Q, T	EUE2-PLOW-1122	1827.40
							1 Power Receptacle, 1 Smart USB-A+C Charging, 4 Data Ports	Q, T	EUE2-PLOW-1140	1827.40
					1 Power Receptacle, 2 Smart USB-A+C Charging, 1 Data Port, 1 Cable Bay		Q, T	EUE2-PLOW-1212	1930.92	
					1 Power Receptacle, 2 Smart USB-A+C Charging, 3 Data Ports		Q, T	EUE2-PLOW-1230	1930.92	
					1 Power Receptacle, 3 Smart USB-A+C Charging, 1 Cable Bay		Q, T	EUE2-PLOW-1302	2034.44	
					1 Power Receptacle, 3 Smart USB-A+C Charging, 2 Data Ports		Q, T	EUE2-PLOW-1320	2034.44	
					2 Power Receptacles, 2 Data Ports, 1 Cable Bay		Q, T	EUE2-PLOW-2022	1723.88	
					2 Power Receptacles, 4 Data Ports		Q, T	EUE2-PLOW-2040	1723.88	
					2 Power Receptacles, 1 Smart USB-A+C Charging, 1 Data Port, 1 Cable Bay		Q, T	EUE2-PLOW-2112	1827.40	
					2 Power Receptacles, 1 Smart USB-A+C Charging, 3 Data Ports		Q, T	EUE2-PLOW-2130	1827.40	
					2 Power Receptacles, 2 Smart USB-A+C Charging, 1 Cable Bay		Q, T	EUE2-PLOW-2202	1930.92	
					2 Power Receptacles, 2 Smart USB-A+C Charging, 2 Data Ports		Q, T	EUE2-PLOW-2220	1930.92	
					2 Power Receptacles, 3 Smart USB-A+C Charging, 1 Data Port		Q, T	EUE2-PLOW-2310	2034.44	
					2 Power Receptacles, 4 Smart USB-A+C Charging		Q, T	EUE2-PLOW-2400	2137.96	
					3 Power Receptacles, 1 Data Port, 1 Cable Bay	Q, T	EUE2-PLOW-3012	1723.88		
					3 Power Receptacles, 3 Data Ports	Q, T	EUE2-PLOW-3030	1723.88		
					3 Power Receptacles, 1 Smart USB-A+C Charging, 1 Cable Bay	Q, T	EUE2-PLOW-3102	1827.40		
					3 Power Receptacles, 1 Smart USB-A+C Charging, 2 Data Ports	Q, T	EUE2-PLOW-3120	1827.40		
3 Power Receptacles, 2 Smart USB-A+C Charging, 1 Data Port	Q, T	EUE2-PLOW-3210	1930.92							
3 Power Receptacles, 3 Smart USB-A+C Charging	Q, T	EUE2-PLOW-3300	2034.44							
4 Power Receptacles, 1 Cable Bay	Q, T	EUE2-PLOW-4002	1723.88							
4 Power Receptacles, 2 Data Ports	Q, T	EUE2-PLOW-4020	1723.88							
4 Power Receptacles, 1 Smart USB-A+C Charging, 1 Data Port	Q, T	EUE2-PLOW-4110	1827.40							
4 Power Receptacles, 2 Smart USB-A+C Charging	Q, T	EUE2-PLOW-4200	1930.92							
5 Power Receptacles, 1 Data Port	Q, T	EUE2-PLOW-5010	1723.88							
5 Power Receptacles, 1 Smart USB-A+C Charging	Q, T	EUE2-PLOW-5100	1827.40							
6 Power Receptacles	Q, T	EUE2-PLOW-6000	1723.88							

Worksurface Power Modules — Flip Top

Hardwire — Single-Sided

Power, Data and USB

4-Port:

- (2) Power
- (1) Smart USB-A+C
- (1) Data

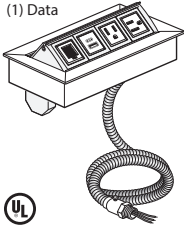

Hard Wired

EUEI-HFOB-2110

6-Port:

- (3) Power
- (1) Smart USB-A+C
- (2) Data

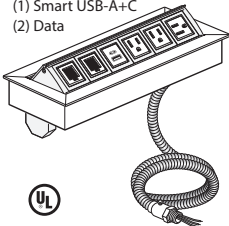

Hard Wired

EUEI-HFOB-1212

Class YA

Features

- Includes bezel and flip top module with 2, 4 or 6 ports that can be configured with simplex outlets (NEMA-5-15R), USB charging port (Smart USB-A+C), data ports or cable bay(s) that can accept up to 2 pull out data/AV cables and mounting hardware.
- Data port accommodate most varieties of field supplied data/ AV jacks.
- Hardwired power module with 6'(1829mm) or 12'(3658mm) long flexible metal conduit feed, 0.5"(13mm) conduit fitting and wires for hardwire connection.
- The Smart USB-A+C allows for the 20W to be transferred between the 2 ports. If the USB-A is being used, the full wattage is sent to the USB-A, and the same for the USB-C. If both are being used, the wattage is distributed to each port and the port drawing the most power will receive more watts than the one that is not.
- Flip top unit is flush mounted with spring release flip module(s).
- Flip top unit overall height is 2.75"(70mm) and will extend below the table tops.
- Color option of black anodized housing with black receptacles or clear anodized housing with white receptacles.

Specification Tips

- Designed to be used with 1.18"(30 mm) and 2"(51mm) thick surfaces with clear space below.
- **Configuration and quantity of power and data ports cannot be modified in the field.**
- **For use with 120 volt 60 hertz power source only.**
- Requires field installation.
- Specify factory cut hole or field cut hole as required.
- Specify AV cables separately.
- Cable Bay requires cables less than 0.3"(8mm) diameter.
- Application may require approval of local authority having jurisdiction (AHJ); ensure compliance before placing orders and installation.

To Order, Specify:

- 1) Product number.
(No finish specification required.)

Note: Order flip top units to match flip top unit cutout option specified for each top (A/B, F/V or J/K).

Worksurface Power Modules — Flip Top

Hardwire — Single-Sided

Bezel Depth	Bezel Width	Cord Length	Trim Color	Port Color	Port	Port Configuration	Cutout		Price		
							Options	Number			
4.37" (111mm)	5.31" (135mm)	6' (1829mm)	Black Anodized	Black	2	1 Power Receptacle, 1 Data Port	A, B	EUE1-HFOB-1010	\$ 1217.56		
						1 Power Receptacle, 1 Smart USB-A+C Charging	A, B	EUE1-HFOB-1100	1321.08		
						2 Power Receptacles	A, B	EUE1-HFOB-2000	1217.56		
						4	1 Power Receptacle, 1 Data Port, 1 Cable Bay	F, V	EUE1-HFOB-1012	\$ 1217.56	
							1 Power Receptacle, 3 Data Ports	F, V	EUE1-HFOB-1030	1217.56	
							1 Power Receptacle, 1 Smart USB-A+C Charging, 1 Cable Bay	F, V	EUE1-HFOB-1102	1321.08	
							1 Power Receptacle, 1 Smart USB-A+C Charging, 2 Data Ports	F, V	EUE1-HFOB-1120	1321.08	
							1 Power Receptacle, 3 Smart USB-A+C Charging	F, V	EUE1-HFOB-1300	1528.12	
							2 Power Receptacles, 1 Cable Bay	F, V	EUE1-HFOB-2002	1217.56	
							2 Power Receptacles, 2 Data Ports	F, V	EUE1-HFOB-2020	1217.56	
							2 Power Receptacles, 1 Smart USB-A+C Charging, 1 Data Port	F, V	EUE1-HFOB-2110	1321.08	
							2 Power Receptacles, 2 Smart USB-A+C Charging	F, V	EUE1-HFOB-2200	1424.60	
							3 Power Receptacles, 1 Data Port	F, V	EUE1-HFOB-3010	1217.56	
							3 Power Receptacles, 1 Smart USB-A+C Charging	F, V	EUE1-HFOB-3100	1321.08	
							4 Power Receptacles	F, V	EUE1-HFOB-4000	1217.56	
							6	1 Power Receptacle, 3 Data Ports, 1 Cable Bay	J, K	EUE1-HFOB-1032	\$ 1217.56
								1 Power Receptacle, 5 Data Ports	J, K	EUE1-HFOB-1050	1217.56
								1 Power Receptacle, 1 Smart USB-A+C Charging, 2 Data Ports, 1 Cable Bay	J, K	EUE1-HFOB-1122	1321.08
						1 Power Receptacle, 1 Smart USB-A+C Charging, 4 Data Ports		J, K	EUE1-HFOB-1140	1321.08	
						1 Power Receptacle, 2 Smart USB-A+C Charging, 1 Data Port, 1 Cable Bay		J, K	EUE1-HFOB-1212	1424.60	
						1 Power Receptacle, 2 Smart USB-A+C Charging, 3 Data Ports		J, K	EUE1-HFOB-1230	1424.60	
						1 Power Receptacle, 3 Smart USB-A+C Charging, 1 Cable Bay		J, K	EUE1-HFOB-1302	1528.12	
						1 Power Receptacle, 3 Smart USB-A+C Charging, 2 Data Ports		J, K	EUE1-HFOB-1320	1528.12	
						2 Power Receptacles, 2 Data Ports, 1 Cable Bay		J, K	EUE1-HFOB-2022	1217.56	
						2 Power Receptacles, 4 Data Ports		J, K	EUE1-HFOB-2040	1217.56	
						2 Power Receptacles, 1 Smart USB-A+C Charging, 1 Data Port, 1 Cable Bay		J, K	EUE1-HFOB-2112	1321.08	
						2 Power Receptacles, 1 Smart USB-A+C Charging, 3 Data Ports		J, K	EUE1-HFOB-2130	1321.08	
						2 Power Receptacles, 2 Smart USB-A+C Charging, 1 Cable Bay		J, K	EUE1-HFOB-2202	1424.60	
						2 Power Receptacles, 2 Smart USB-A+C Charging, 2 Data Ports		J, K	EUE1-HFOB-2220	1424.60	
						2 Power Receptacles, 3 Smart USB-A+C Charging, 1 Data Port		J, K	EUE1-HFOB-2310	1528.12	
						2 Power Receptacles, 4 Smart USB-A+C Charging		J, K	EUE1-HFOB-2400	1631.64	
						3 Power Receptacles, 1 Data Port, 1 Cable Bay		J, K	EUE1-HFOB-3012	1217.56	
						3 Power Receptacles, 3 Data Ports		J, K	EUE1-HFOB-3030	1217.56	
3 Power Receptacles, 1 Smart USB-A+C Charging, 1 Cable Bay	J, K	EUE1-HFOB-3102	1321.08								
3 Power Receptacles, 1 Smart USB-A+C Charging, 2 Data Ports	J, K	EUE1-HFOB-3120	1321.08								
3 Power Receptacles, 2 Smart USB-A+C Charging, 1 Data Port	J, K	EUE1-HFOB-3210	1424.60								
3 Power Receptacles, 3 Smart USB-A+C Charging	J, K	EUE1-HFOB-3300	1528.12								
4 Power Receptacles, 1 Cable Bay	J, K	EUE1-HFOB-4002	1217.56								
4 Power Receptacles, 2 Data Ports	J, K	EUE1-HFOB-4020	1217.56								
4 Power Receptacles, 1 Smart USB-A+C Charging, 1 Data Port	J, K	EUE1-HFOB-4110	1321.08								
4 Power Receptacles, 2 Smart USB-A+C Charging	J, K	EUE1-HFOB-4200	1424.60								
5 Power Receptacles, 1 Data Port	J, K	EUE1-HFOB-5010	1217.56								
5 Power Receptacles, 1 Smart USB-A+C Charging	J, K	EUE1-HFOB-5100	1321.08								
6 Power Receptacles	J, K	EUE1-HFOB-6000	1217.56								

Worksurface Power Modules — Flip Top

Hardwire — Single-Sided

Bezel Depth	Bezel Width	Cord Length	Trim Color	Port Color	Port	Port Configuration	Cutout		Price	
							Options	Number		
4.37" (111mm)	5.31" (135mm)	6' (1829mm)	Clear Anodized	White	2	1 Power Receptacle, 1 Data Port	A, B	EUE1-HFOW-1010	\$ 937.57	
						1 Power Receptacle, 1 Smart USB-A+C Charging	A, B	EUE1-HFOW-1100	1041.09	
						2 Power Receptacles	A, B	EUE1-HFOW-2000	937.57	
						4	1 Power Receptacle, 1 Data Port, 1 Cable Bay	F, V	EUE1-HFOW-1012	\$ 937.57
							1 Power Receptacle, 3 Data Ports	F, V	EUE1-HFOW-1030	937.57
							1 Power Receptacle, 1 Smart USB-A+C Charging, 1 Cable Bay	F, V	EUE1-HFOW-1102	1041.09
							1 Power Receptacle, 1 Smart USB-A+C Charging, 2 Data Ports	F, V	EUE1-HFOW-1120	1041.09
							1 Power Receptacle, 3 Smart USB-A+C Charging	F, V	EUE1-HFOW-1300	1248.13
							2 Power Receptacles, 1 Cable Bay	F, V	EUE1-HFOW-2002	937.57
							2 Power Receptacles, 2 Data Ports	F, V	EUE1-HFOW-2020	937.57
							2 Power Receptacles, 1 Smart USB-A+C Charging, 1 Data Port	F, V	EUE1-HFOW-2110	1041.09
							2 Power Receptacles, 2 Smart USB-A+C Charging	F, V	EUE1-HFOW-2200	1144.61
							3 Power Receptacles, 1 Data Port	F, V	EUE1-HFOW-3010	937.57
							3 Power Receptacles, 1 Smart USB-A+C Charging	F, V	EUE1-HFOW-3100	1041.09
							4 Power Receptacles	F, V	EUE1-HFOW-4000	937.57
						6	1 Power Receptacle, 3 Data Ports, 1 Cable Bay	J, K	EUE1-HFOW-1032	\$ 937.57
							1 Power Receptacle, 5 Data Ports	J, K	EUE1-HFOW-1050	937.57
							1 Power Receptacle, 1 Smart USB-A+C Charging, 2 Data Ports, 1 Cable Bay	J, K	EUE1-HFOW-1122	1041.09
							1 Power Receptacle, 1 Smart USB-A+C Charging, 4 Data Ports	J, K	EUE1-HFOW-1140	1041.09
							1 Power Receptacle, 2 Smart USB-A+C Charging, 1 Data Port, 1 Cable Bay	J, K	EUE1-HFOW-1212	1144.61
							1 Power Receptacle, 2 Smart USB-A+C Charging, 3 Data Ports	J, K	EUE1-HFOW-1230	1144.61
							1 Power Receptacle, 3 Smart USB-A+C Charging, 1 Cable Bay	J, K	EUE1-HFOW-1302	1248.13
							1 Power Receptacle, 3 Smart USB-A+C Charging, 2 Data Ports	J, K	EUE1-HFOW-1320	1248.13
							2 Power Receptacles, 2 Data Ports, 1 Cable Bay	J, K	EUE1-HFOW-2022	937.57
							2 Power Receptacles, 4 Data Ports	J, K	EUE1-HFOW-2040	937.57
							2 Power Receptacles, 1 Smart USB-A+C Charging, 1 Data Port, 1 Cable Bay	J, K	EUE1-HFOW-2112	1041.09
							2 Power Receptacles, 1 Smart USB-A+C Charging, 3 Data Ports	J, K	EUE1-HFOW-2130	1041.09
							2 Power Receptacles, 2 Smart USB-A+C Charging, 1 Cable Bay	J, K	EUE1-HFOW-2202	1144.61
							2 Power Receptacles, 2 Smart USB-A+C Charging, 2 Data Ports	J, K	EUE1-HFOW-2220	1144.61
							2 Power Receptacles, 3 Smart USB-A+C Charging, 1 Data Port	J, K	EUE1-HFOW-2310	1248.13
2 Power Receptacles, 4 Smart USB-A+C Charging	J, K	EUE1-HFOW-2400	1351.65							
3 Power Receptacles, 1 Data Port, 1 Cable Bay	J, K	EUE1-HFOW-3012	937.57							
3 Power Receptacles, 3 Data Ports	J, K	EUE1-HFOW-3030	937.57							
3 Power Receptacles, 1 Smart USB-A+C Charging, 1 Cable Bay	J, K	EUE1-HFOW-3102	1041.09							
3 Power Receptacles, 1 Smart USB-A+C Charging, 2 Data Ports	J, K	EUE1-HFOW-3120	1041.09							
3 Power Receptacles, 2 Smart USB-A+C Charging, 1 Data Port	J, K	EUE1-HFOW-3210	1144.61							
3 Power Receptacles, 3 Smart USB-A+C Charging	J, K	EUE1-HFOW-3300	1248.13							
4 Power Receptacles, 1 Cable Bay	J, K	EUE1-HFOW-4002	937.57							
4 Power Receptacles, 2 Data Ports	J, K	EUE1-HFOW-4020	937.57							
4 Power Receptacles, 1 Smart USB-A+C Charging, 1 Data Port	J, K	EUE1-HFOW-4110	1041.09							
4 Power Receptacles, 2 Smart USB-A+C Charging	J, K	EUE1-HFOW-4200	1144.61							
5 Power Receptacles, 1 Data Port	J, K	EUE1-HFOW-5010	937.57							
5 Power Receptacles, 1 Smart USB-A+C Charging	J, K	EUE1-HFOW-5100	1041.09							
6 Power Receptacles	J, K	EUE1-HFOW-6000	937.57							

Worksurface Power Modules — Flip Top

Hardwire — Single-Sided

Bezel Depth	Bezel Width	Cord Length	Trim Color	Port Color	Port	Port Configuration	Cutout		Price		
							Code	Options Number			
4.37" (111mm)	5.31" (135mm)	12' (3658mm)	Black Anodized	Black	2	1 Power Receptacle, 1 Data Port	A, B	EUE1-HLOB-1010	\$1302.16		
						1 Power Receptacle, 1 Smart USB-A+C Charging	A, B	EUE1-HLOB-1100	1405.68		
						2 Power Receptacles	A, B	EUE1-HLOB-2000	1302.16		
						4	1 Power Receptacle, 1 Data Port, 1 Cable Bay	F, V	EUE1-HLOB-1012	\$1302.16	
							1 Power Receptacle, 3 Data Ports	F, V	EUE1-HLOB-1030	1302.16	
							1 Power Receptacle, 1 Smart USB-A+C Charging, 1 Cable Bay	F, V	EUE1-HLOB-1102	1405.68	
							1 Power Receptacle, 1 Smart USB-A+C Charging, 2 Data Ports	F, V	EUE1-HLOB-1120	1405.68	
							1 Power Receptacle, 3 Smart USB-A+C Charging	F, V	EUE1-HLOB-1300	1612.72	
							2 Power Receptacles, 1 Cable Bay	F, V	EUE1-HLOB-2002	1302.16	
							2 Power Receptacles, 2 Data Ports	F, V	EUE1-HLOB-2020	1302.16	
							2 Power Receptacles, 1 Smart USB-A+C Charging, 1 Data Port	F, V	EUE1-HLOB-2110	1405.68	
							2 Power Receptacles, 2 Smart USB-A+C Charging	F, V	EUE1-HLOB-2200	1509.20	
							3 Power Receptacles, 1 Data Port	F, V	EUE1-HLOB-3010	1302.16	
							3 Power Receptacles, 1 Smart USB-A+C Charging	F, V	EUE1-HLOB-3100	1405.68	
							4 Power Receptacles	F, V	EUE1-HLOB-4000	1302.16	
							6	1 Power Receptacle, 3 Data Ports, 1 Cable Bay	J, K	EUE1-HLOB-1032	\$1302.16
								1 Power Receptacle, 5 Data Ports	J, K	EUE1-HLOB-1050	1302.16
								1 Power Receptacle, 1 Smart USB-A+C Charging, 2 Data Ports, 1 Cable Bay	J, K	EUE1-HLOB-1122	1405.68
						1 Power Receptacle, 1 Smart USB-A+C Charging, 4 Data Ports		J, K	EUE1-HLOB-1140	1405.68	
						1 Power Receptacle, 2 Smart USB-A+C Charging, 1 Data Port, 1 Cable Bay		J, K	EUE1-HLOB-1212	1509.20	
						1 Power Receptacle, 2 Smart USB-A+C Charging, 3 Data Ports		J, K	EUE1-HLOB-1230	1509.20	
						1 Power Receptacle, 3 Smart USB-A+C Charging, 1 Cable Bay		J, K	EUE1-HLOB-1302	1612.72	
						1 Power Receptacle, 3 Smart USB-A+C Charging, 2 Data Ports		J, K	EUE1-HLOB-1320	1612.72	
						2 Power Receptacles, 2 Data Ports, 1 Cable Bay		J, K	EUE1-HLOB-2022	1302.16	
						2 Power Receptacles, 4 Data Ports		J, K	EUE1-HLOB-2040	1302.16	
						2 Power Receptacles, 1 Smart USB-A+C Charging, 1 Data Port, 1 Cable Bay		J, K	EUE1-HLOB-2112	1405.68	
						2 Power Receptacles, 1 Smart USB-A+C Charging, 3 Data Ports		J, K	EUE1-HLOB-2130	1405.68	
						2 Power Receptacles, 2 Smart USB-A+C Charging, 1 Cable Bay		J, K	EUE1-HLOB-2202	1509.20	
						2 Power Receptacles, 2 Smart USB-A+C Charging, 2 Data Ports		J, K	EUE1-HLOB-2220	1509.20	
						2 Power Receptacles, 3 Smart USB-A+C Charging, 1 Data Port		J, K	EUE1-HLOB-2310	1612.72	
						2 Power Receptacles, 4 Smart USB-A+C Charging		J, K	EUE1-HLOB-2400	1716.24	
						3 Power Receptacles, 1 Data Port, 1 Cable Bay		J, K	EUE1-HLOB-3012	1302.16	
						3 Power Receptacles, 3 Data Ports		J, K	EUE1-HLOB-3030	1302.16	
3 Power Receptacles, 1 Smart USB-A+C Charging, 1 Cable Bay	J, K	EUE1-HLOB-3102	1405.68								
3 Power Receptacles, 1 Smart USB-A+C Charging, 2 Data Ports	J, K	EUE1-HLOB-3120	1405.68								
3 Power Receptacles, 2 Smart USB-A+C Charging, 1 Data Port	J, K	EUE1-HLOB-3210	1509.20								
3 Power Receptacles, 3 Smart USB-A+C Charging	J, K	EUE1-HLOB-3300	1612.72								
4 Power Receptacles, 1 Cable Bay	J, K	EUE1-HLOB-4002	1302.16								
4 Power Receptacles, 2 Data Ports	J, K	EUE1-HLOB-4020	1302.16								
4 Power Receptacles, 1 Smart USB-A+C Charging, 1 Data Port	J, K	EUE1-HLOB-4110	1405.68								
4 Power Receptacles, 2 Smart USB-A+C Charging	J, K	EUE1-HLOB-4200	1509.20								
5 Power Receptacles, 1 Data Port	J, K	EUE1-HLOB-5010	1302.16								
5 Power Receptacles, 1 Smart USB-A+C Charging	J, K	EUE1-HLOB-5100	1405.68								
6 Power Receptacles	J, K	EUE1-HLOB-6000	1302.16								

Worksurface Power Modules — Flip Top

Hardwire — Single-Sided

Bezel Depth	Bezel Width	Cord Length	Trim Color	Port Color	Port	Port Configuration	Cutout	Number	Price		
							Code Options				
4.37" (111mm)	5.31" (135mm)	12' (3658mm)	Clear Anodized	White	2	1 Power Receptacle, 1 Data Port	A, B	EUE1-HLOW-1010	\$1022.17		
						1 Power Receptacle, 1 Smart USB-A+C Charging	A, B	EUE1-HLOW-1100	1125.69		
						2 Power Receptacles	A, B	EUE1-HLOW-2000	1022.17		
						4	1 Power Receptacle, 1 Data Port, 1 Cable Bay	F, V	EUE1-HLOW-1012	\$1022.17	
							1 Power Receptacle, 3 Data Ports	F, V	EUE1-HLOW-1030	1022.17	
							1 Power Receptacle, 1 Smart USB-A+C Charging, 1 Cable Bay	F, V	EUE1-HLOW-1102	1125.69	
							1 Power Receptacle, 1 Smart USB-A+C Charging, 2 Data Ports	F, V	EUE1-HLOW-1120	1125.69	
							1 Power Receptacle, 3 Smart USB-A+C Charging	F, V	EUE1-HLOW-1300	1332.73	
							2 Power Receptacles, 1 Cable Bay	F, V	EUE1-HLOW-2002	1022.17	
							2 Power Receptacles, 2 Data Ports	F, V	EUE1-HLOW-2020	1022.17	
							2 Power Receptacles, 1 Smart USB-A+C Charging, 1 Data Port	F, V	EUE1-HLOW-2110	1125.69	
							2 Power Receptacles, 2 Smart USB-A+C Charging	F, V	EUE1-HLOW-2200	1229.21	
							3 Power Receptacles, 1 Data Port	F, V	EUE1-HLOW-3010	1022.17	
							3 Power Receptacles, 1 Smart USB-A+C Charging	F, V	EUE1-HLOW-3100	1125.69	
							4 Power Receptacles	F, V	EUE1-HLOW-4000	1022.17	
							6	1 Power Receptacle, 3 Data Ports, 1 Cable Bay	J, K	EUE1-HLOW-1032	\$1022.17
								1 Power Receptacle, 5 Data Ports	J, K	EUE1-HLOW-1050	1022.17
								1 Power Receptacle, 1 Smart USB-A+C Charging, 2 Data Ports, 1 Cable Bay	J, K	EUE1-HLOW-1122	1125.69
						1 Power Receptacle, 1 Smart USB-A+C Charging, 4 Data Ports		J, K	EUE1-HLOW-1140	1125.69	
						1 Power Receptacle, 2 Smart USB-A+C Charging, 1 Data Port, 1 Cable Bay		J, K	EUE1-HLOW-1212	1229.21	
						1 Power Receptacle, 2 Smart USB-A+C Charging, 3 Data Ports		J, K	EUE1-HLOW-1230	1229.21	
						1 Power Receptacle, 3 Smart USB-A+C Charging, 1 Cable Bay		J, K	EUE1-HLOW-1302	1332.73	
						1 Power Receptacle, 3 Smart USB-A+C Charging, 2 Data Ports		J, K	EUE1-HLOW-1320	1332.73	
						2 Power Receptacles, 2 Data Ports, 1 Cable Bay		J, K	EUE1-HLOW-2022	1022.17	
						2 Power Receptacles, 4 Data Ports		J, K	EUE1-HLOW-2040	1022.17	
						2 Power Receptacles, 1 Smart USB-A+C Charging, 1 Data Port, 1 Cable Bay		J, K	EUE1-HLOW-2112	1125.69	
						2 Power Receptacles, 1 Smart USB-A+C Charging, 3 Data Ports		J, K	EUE1-HLOW-2130	1125.69	
						2 Power Receptacles, 2 Smart USB-A+C Charging, 1 Cable Bay		J, K	EUE1-HLOW-2202	1229.21	
						2 Power Receptacles, 2 Smart USB-A+C Charging, 2 Data Ports		J, K	EUE1-HLOW-2220	1229.21	
						2 Power Receptacles, 3 Smart USB-A+C Charging, 1 Data Port		J, K	EUE1-HLOW-2310	1332.73	
						2 Power Receptacles, 4 Smart USB-A+C Charging		J, K	EUE1-HLOW-2400	1436.25	
						3 Power Receptacles, 1 Data Port, 1 Cable Bay		J, K	EUE1-HLOW-3012	1022.17	
						3 Power Receptacles, 3 Data Ports		J, K	EUE1-HLOW-3030	1022.17	
3 Power Receptacles, 1 Smart USB-A+C Charging, 1 Cable Bay	J, K	EUE1-HLOW-3102	1125.69								
3 Power Receptacles, 1 Smart USB-A+C Charging, 2 Data Ports	J, K	EUE1-HLOW-3120	1125.69								
3 Power Receptacles, 2 Smart USB-A+C Charging, 1 Data Port	J, K	EUE1-HLOW-3210	1229.21								
3 Power Receptacles, 3 Smart USB-A+C Charging	J, K	EUE1-HLOW-3300	1332.73								
4 Power Receptacles, 1 Cable Bay	J, K	EUE1-HLOW-4002	1022.17								
4 Power Receptacles, 2 Data Ports	J, K	EUE1-HLOW-4020	1022.17								
4 Power Receptacles, 1 Smart USB-A+C Charging, 1 Data Port	J, K	EUE1-HLOW-4110	1125.69								
4 Power Receptacles, 2 Smart USB-A+C Charging	J, K	EUE1-HLOW-4200	1229.21								
5 Power Receptacles, 1 Data Port	J, K	EUE1-HLOW-5010	1022.17								
5 Power Receptacles, 1 Smart USB-A+C Charging	J, K	EUE1-HLOW-5100	1125.69								
6 Power Receptacles	J, K	EUE1-HLOW-6000	1022.17								

Worksurface Power Modules — Flip Top

Hardwire — Double-Sided

Power, Data and USB

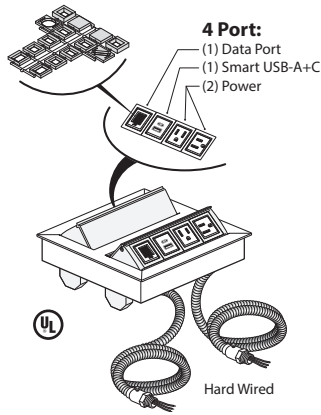

EUE2-HFOB-2110

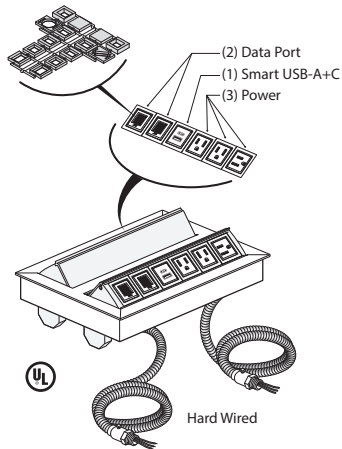

EUE2-HFOB-1212

Class YA

Features

- Includes bezel and two flip top modules, each with 2, 4 or 6 ports that can be configured with simplex outlets (NEMA-5-15R), USB charging port (Smart USB-A+C), data ports or cable bay(s) that can accept up to 2 pull out data/AV cables and mounting hardware.
- Data port accommodate most varieties of field supplied data/ AV jacks.
- Each flip top module within the bezel provided with 6'(1829mm) or 12'(3658mm) long flexible metal conduit feed, 0.5"(13mm) conduit fitting and wires for hardwire connection.
- The Smart USB-A+C allows for the 20W to be transferred between the 2 ports. If the USB-A is being used, the full wattage is sent to the USB-A, and the same for the USB-C. If both are being used, the wattage is distributed to each port and the port drawing the most power will receive more watts than the one that is not.
- Flip top frame is flush mounted with two spring release flip module(s).
- Flip top unit overall height is 2.75"(70mm) and will extend below the table tops.
- Color option of black anodized housing with black receptacles or clear anodized housing with white receptacles.
- Ships assembled.

Specification Tips

- Designed to be used with 1.18"(30mm) and 2"(51mm) thick surfaces with clear space below.
- **Configuration and quantity of power and data ports cannot be modified in the field.**
- **For use with 120 volt 60 hertz power source only.**
- Note two conduit feeds are provided from the double-sided flip top unit.
- Requires field installation.
- Specify factory cut hole or field cut hole as required.
- Specify AV cables separately.
- Cable Bay requires cables less than 0.3"(8mm) diameter.
- Application may require approval of local authority having jurisdiction (AHJ); ensure compliance before placing orders and installation.

To Order, Specify:

- 1) Product number.
(No finish specification required.)

Note: Order flip top units to match flip top unit cutout option specified for each top (M/P or Q/V).

Worksurface Power Modules — Flip Top

Hardwire — Double-Sided

Bezel Depth	Bezel Width	Cord Length	Trim Color	Port Color	Port	Port Configuration	Cutout	Number	Price	
							Code			
							Options			
8" (203mm)	5.31" (135mm)	6' (1829mm)	Black Anodized	Black	4	1 Power Receptacle, 1 Data Port, 1 Cable Bay	M, P	EUE2-HFOB-1012	\$ 2149.93	
						1 Power Receptacle, 3 Data Ports	M, P	EUE2-HFOB-1030	2149.93	
						1 Power Receptacle, 1 Smart USB-A+C Charging, 1 Cable Bay	M, P	EUE2-HFOB-1102	2253.45	
						1 Power Receptacle, 1 Smart USB-A+C Charging, 2 Data Ports	M, P	EUE2-HFOB-1120	2253.45	
						1 Power Receptacle, 3 Smart USB-A+C Charging	M, P	EUE2-HFOB-1300	2460.49	
						2 Power Receptacles, 1 Cable Bay	M, P	EUE2-HFOB-2002	2149.93	
						2 Power Receptacles, 2 Data Ports	M, P	EUE2-HFOB-2020	2149.93	
						2 Power Receptacles, 1 Smart USB-A+C Charging, 1 Data Port	M, P	EUE2-HFOB-2110	2253.45	
						2 Power Receptacles, 2 Smart USB-A+C Charging	M, P	EUE2-HFOB-2200	2356.97	
						3 Power Receptacles, 1 Data Port	M, P	EUE2-HFOB-3010	2149.93	
						3 Power Receptacles, 1 Smart USB-A+C Charging	M, P	EUE2-HFOB-3100	2253.45	
						4 Power Receptacles	M, P	EUE2-HFOB-4000	2149.93	
						6	1 Power Receptacle, 3 Data Ports, 1 Cable Bay	Q, V	EUE2-HFOB-1032	\$ 2149.93
							1 Power Receptacle, 5 Data Ports	Q, V	EUE2-HFOB-1050	2149.93
							1 Power Receptacle, 1 Smart USB-A+C Charging, 2 Data Ports, 1 Cable Bay	Q, V	EUE2-HFOB-1122	2253.45
							1 Power Receptacle, 1 Smart USB-A+C Charging, 4 Data Ports	Q, V	EUE2-HFOB-1140	2253.45
					1 Power Receptacle, 2 Smart USB-A+C Charging, 1 Data Port, 1 Cable Bay		Q, V	EUE2-HFOB-1212	2356.97	
					1 Power Receptacle, 2 Smart USB-A+C Charging, 3 Data Ports		Q, V	EUE2-HFOB-1230	2356.97	
					1 Power Receptacle, 3 Smart USB-A+C Charging, 1 Cable Bay		Q, V	EUE2-HFOB-1302	2460.49	
					1 Power Receptacle, 3 Smart USB-A+C Charging, 2 Data Ports		Q, V	EUE2-HFOB-1320	2460.49	
					2 Power Receptacles, 2 Data Ports, 1 Cable Bay		Q, V	EUE2-HFOB-2022	2149.93	
					2 Power Receptacles, 4 Data Ports		Q, V	EUE2-HFOB-2040	2149.93	
					2 Power Receptacles, 1 Smart USB-A+C Charging, 1 Data Port, 1 Cable Bay		Q, V	EUE2-HFOB-2112	2253.45	
					2 Power Receptacles, 1 Smart USB-A+C Charging, 3 Data Ports		Q, V	EUE2-HFOB-2130	2253.45	
					2 Power Receptacles, 2 Smart USB-A+C Charging, 1 Cable Bay		Q, V	EUE2-HFOB-2202	2356.97	
					2 Power Receptacles, 2 Smart USB-A+C Charging, 2 Data Ports		Q, V	EUE2-HFOB-2220	2356.97	
					2 Power Receptacles, 3 Smart USB-A+C Charging, 1 Data Port		Q, V	EUE2-HFOB-2310	2460.49	
					2 Power Receptacles, 4 Smart USB-A+C Charging		Q, V	EUE2-HFOB-2400	2564.01	
					3 Power Receptacles, 1 Data Port, 1 Cable Bay	Q, V	EUE2-HFOB-3012	2149.93		
					3 Power Receptacles, 3 Data Ports	Q, V	EUE2-HFOB-3030	2149.93		
					3 Power Receptacles, 1 Smart USB-A+C Charging, 1 Cable Bay	Q, V	EUE2-HFOB-3102	2253.45		
					3 Power Receptacles, 1 Smart USB-A+C Charging, 2 Data Ports	Q, V	EUE2-HFOB-3120	2253.45		
3 Power Receptacles, 2 Smart USB-A+C Charging, 1 Data Port	Q, V	EUE2-HFOB-3210	2356.97							
3 Power Receptacles, 3 Smart USB-A+C Charging	Q, V	EUE2-HFOB-3300	2460.49							
4 Power Receptacles, 1 Cable Bay	Q, V	EUE2-HFOB-4002	2149.93							
4 Power Receptacles, 2 Data Ports	Q, V	EUE2-HFOB-4020	2149.93							
4 Power Receptacles, 1 Smart USB-A+C Charging, 1 Data Port	Q, V	EUE2-HFOB-4110	2253.45							
4 Power Receptacles, 2 Smart USB-A+C Charging	Q, V	EUE2-HFOB-4200	2356.97							
5 Power Receptacles, 1 Data Port	Q, V	EUE2-HFOB-5010	2149.93							
5 Power Receptacles, 1 Smart USB-A+C Charging	Q, V	EUE2-HFOB-5100	2253.45							
6 Power Receptacles	Q, V	EUE2-HFOB-6000	2149.93							

Worksurface Power Modules — Flip Top

Hardwire — Double-Sided

Bezel Depth	Bezel Width	Cord Length	Trim Color	Port Color	Port	Port Configuration	Cutout		Price	
							Code	Options Number		
8" (203mm)	5.31" (135mm)	6' (1829mm)	Clear Anodized	White	4	1 Power Receptacle, 1 Data Port, 1 Cable Bay	M, P	EUE2-HFOW-1012	\$ 1869.94	
						1 Power Receptacle, 3 Data Ports	M, P	EUE2-HFOW-1030	1869.94	
						1 Power Receptacle, 1 Smart USB-A+C Charging, 1 Cable Bay	M, P	EUE2-HFOW-1102	1973.46	
						1 Power Receptacle, 1 Smart USB-A+C Charging, 2 Data Ports	M, P	EUE2-HFOW-1120	1973.46	
						1 Power Receptacle, 3 Smart USB-A+C Charging	M, P	EUE2-HFOW-1300	2180.50	
						2 Power Receptacles, 1 Cable Bay	M, P	EUE2-HFOW-2002	1869.94	
						2 Power Receptacles, 2 Data Ports	M, P	EUE2-HFOW-2020	1869.94	
						2 Power Receptacles, 1 Smart USB-A+C Charging, 1 Data Port	M, P	EUE2-HFOW-2110	1973.46	
						2 Power Receptacles, 2 Smart USB-A+C Charging	M, P	EUE2-HFOW-2200	2076.98	
						3 Power Receptacles, 1 Data Port	M, P	EUE2-HFOW-3010	1869.94	
						3 Power Receptacles, 1 Smart USB-A+C Charging	M, P	EUE2-HFOW-3100	1973.46	
						4 Power Receptacles	M, P	EUE2-HFOW-4000	1869.94	
						6	1 Power Receptacle, 3 Data Ports, 1 Cable Bay	Q, V	EUE2-HFOW-1032	\$ 1869.94
							1 Power Receptacle, 5 Data Ports	Q, V	EUE2-HFOW-1050	1869.94
							1 Power Receptacle, 1 Smart USB-A+C Charging, 2 Data Ports, 1 Cable Bay	Q, V	EUE2-HFOW-1122	1973.46
							1 Power Receptacle, 1 Smart USB-A+C Charging, 4 Data Ports	Q, V	EUE2-HFOW-1140	1973.46
					1 Power Receptacle, 2 Smart USB-A+C Charging, 1 Data Port, 1 Cable Bay		Q, V	EUE2-HFOW-1212	2076.98	
					1 Power Receptacle, 2 Smart USB-A+C Charging, 3 Data Ports		Q, V	EUE2-HFOW-1230	2076.98	
					1 Power Receptacle, 3 Smart USB-A+C Charging, 1 Cable Bay		Q, V	EUE2-HFOW-1302	2180.50	
					1 Power Receptacle, 3 Smart USB-A+C Charging, 2 Data Ports		Q, V	EUE2-HFOW-1320	2180.50	
					2 Power Receptacles, 2 Data Ports, 1 Cable Bay		Q, V	EUE2-HFOW-2022	1869.94	
					2 Power Receptacles, 4 Data Ports		Q, V	EUE2-HFOW-2040	1869.94	
					2 Power Receptacles, 1 Smart USB-A+C Charging, 1 Data Port, 1 Cable Bay		Q, V	EUE2-HFOW-2112	1973.46	
					2 Power Receptacles, 1 Smart USB-A+C Charging, 3 Data Ports		Q, V	EUE2-HFOW-2130	1973.46	
					2 Power Receptacles, 2 Smart USB-A+C Charging, 1 Cable Bay		Q, V	EUE2-HFOW-2202	2076.98	
					2 Power Receptacles, 2 Smart USB-A+C Charging, 2 Data Ports		Q, V	EUE2-HFOW-2220	2076.98	
					2 Power Receptacles, 3 Smart USB-A+C Charging, 1 Data Port		Q, V	EUE2-HFOW-2310	2180.50	
					2 Power Receptacles, 4 Smart USB-A+C Charging		Q, V	EUE2-HFOW-2400	2284.02	
					3 Power Receptacles, 1 Data Port, 1 Cable Bay	Q, V	EUE2-HFOW-3012	1869.94		
					3 Power Receptacles, 3 Data Ports	Q, V	EUE2-HFOW-3030	1869.94		
					3 Power Receptacles, 1 Smart USB-A+C Charging, 1 Cable Bay	Q, V	EUE2-HFOW-3102	1973.46		
					3 Power Receptacles, 1 Smart USB-A+C Charging, 2 Data Ports	Q, V	EUE2-HFOW-3120	1973.46		
3 Power Receptacles, 2 Smart USB-A+C Charging, 1 Data Port	Q, V	EUE2-HFOW-3210	2076.98							
3 Power Receptacles, 3 Smart USB-A+C Charging	Q, V	EUE2-HFOW-3300	2180.50							
4 Power Receptacles, 1 Cable Bay	Q, V	EUE2-HFOW-4002	1869.94							
4 Power Receptacles, 2 Data Ports	Q, V	EUE2-HFOW-4020	1869.94							
4 Power Receptacles, 1 Smart USB-A+C Charging, 1 Data Port	Q, V	EUE2-HFOW-4110	1973.46							
4 Power Receptacles, 2 Smart USB-A+C Charging	Q, V	EUE2-HFOW-4200	2076.98							
5 Power Receptacles, 1 Data Port	Q, V	EUE2-HFOW-5010	1869.94							
5 Power Receptacles, 1 Smart USB-A+C Charging	Q, V	EUE2-HFOW-5100	1973.46							
6 Power Receptacles	Q, V	EUE2-HFOW-6000	1869.94							

Worksurface Power Modules — Flip Top

Hardwire — Double-Sided

Bezel Depth	Bezel Width	Cord Length	Trim Color	Port Color	Port	Port Configuration	Cutout	Number	Price	
							Code			
							Options			
8" (203mm)	5.31" (135mm)	12' (3658mm)	Black Anodized	Black	4	1 Power Receptacle, 1 Data Port, 1 Cable Bay	M, P	EUE2-HLOB-1012	\$2234.53	
						1 Power Receptacle, 3 Data Ports	M, P	EUE2-HLOB-1030	2234.53	
						1 Power Receptacle, 1 Smart USB-A+C Charging, 1 Cable Bay	M, P	EUE2-HLOB-1102	2338.05	
						1 Power Receptacle, 1 Smart USB-A+C Charging, 2 Data Ports	M, P	EUE2-HLOB-1120	2338.05	
						1 Power Receptacle, 3 Smart USB-A+C Charging	M, P	EUE2-HLOB-1300	2545.09	
						2 Power Receptacles, 1 Cable Bay	M, P	EUE2-HLOB-2002	2234.53	
						2 Power Receptacles, 2 Data Ports	M, P	EUE2-HLOB-2020	2234.53	
						2 Power Receptacles, 1 Smart USB-A+C Charging, 1 Data Port	M, P	EUE2-HLOB-2110	2338.05	
						2 Power Receptacles, 2 Smart USB-A+C Charging	M, P	EUE2-HLOB-2200	2441.57	
						3 Power Receptacles, 1 Data Port	M, P	EUE2-HLOB-3010	2234.53	
						3 Power Receptacles, 1 Smart USB-A+C Charging	M, P	EUE2-HLOB-3100	2338.05	
						4 Power Receptacles	M, P	EUE2-HLOB-4000	2234.53	
						6	1 Power Receptacle, 3 Data Ports, 1 Cable Bay	Q, V	EUE2-HLOB-1032	\$2234.53
							1 Power Receptacle, 5 Data Ports	Q, V	EUE2-HLOB-1050	2234.53
							1 Power Receptacle, 1 Smart USB-A+C Charging, 2 Data Ports, 1 Cable Bay	Q, V	EUE2-HLOB-1122	2338.05
							1 Power Receptacle, 1 Smart USB-A+C Charging, 4 Data Ports	Q, V	EUE2-HLOB-1140	2338.05
					1 Power Receptacle, 2 Smart USB-A+C Charging, 1 Data Port, 1 Cable Bay		Q, V	EUE2-HLOB-1212	2441.57	
					1 Power Receptacle, 2 Smart USB-A+C Charging, 3 Data Ports		Q, V	EUE2-HLOB-1230	2441.57	
					1 Power Receptacle, 3 Smart USB-A+C Charging, 1 Cable Bay		Q, V	EUE2-HLOB-1302	2545.09	
					1 Power Receptacle, 3 Smart USB-A+C Charging, 2 Data Ports		Q, V	EUE2-HLOB-1320	2545.09	
					2 Power Receptacles, 2 Data Ports, 1 Cable Bay		Q, V	EUE2-HLOB-2022	2234.53	
					2 Power Receptacles, 4 Data Ports		Q, V	EUE2-HLOB-2040	2234.53	
					2 Power Receptacles, 1 Smart USB-A+C Charging, 1 Data Port, 1 Cable Bay		Q, V	EUE2-HLOB-2112	2338.05	
					2 Power Receptacles, 1 Smart USB-A+C Charging, 3 Data Ports		Q, V	EUE2-HLOB-2130	2338.05	
					2 Power Receptacles, 2 Smart USB-A+C Charging, 1 Cable Bay		Q, V	EUE2-HLOB-2202	2441.57	
					2 Power Receptacles, 2 Smart USB-A+C Charging, 2 Data Ports		Q, V	EUE2-HLOB-2220	2441.57	
					2 Power Receptacles, 3 Smart USB-A+C Charging, 1 Data Port		Q, V	EUE2-HLOB-2310	2545.09	
					2 Power Receptacles, 4 Smart USB-A+C Charging		Q, V	EUE2-HLOB-2400	2648.61	
					3 Power Receptacles, 1 Data Port, 1 Cable Bay	Q, V	EUE2-HLOB-3012	2234.53		
					3 Power Receptacles, 3 Data Ports	Q, V	EUE2-HLOB-3030	2234.53		
					3 Power Receptacles, 1 Smart USB-A+C Charging, 1 Cable Bay	Q, V	EUE2-HLOB-3102	2338.05		
					3 Power Receptacles, 1 Smart USB-A+C Charging, 2 Data Ports	Q, V	EUE2-HLOB-3120	2338.05		
3 Power Receptacles, 2 Smart USB-A+C Charging, 1 Data Port	Q, V	EUE2-HLOB-3210	2441.57							
3 Power Receptacles, 3 Smart USB-A+C Charging	Q, V	EUE2-HLOB-3300	2545.09							
4 Power Receptacles, 1 Cable Bay	Q, V	EUE2-HLOB-4002	2234.53							
4 Power Receptacles, 2 Data Ports	Q, V	EUE2-HLOB-4020	2234.53							
4 Power Receptacles, 1 Smart USB-A+C Charging, 1 Data Port	Q, V	EUE2-HLOB-4110	2338.05							
4 Power Receptacles, 2 Smart USB-A+C Charging	Q, V	EUE2-HLOB-4200	2441.57							
5 Power Receptacles, 1 Data Port	Q, V	EUE2-HLOB-5010	2234.53							
5 Power Receptacles, 1 Smart USB-A+C Charging	Q, V	EUE2-HLOB-5100	2338.05							
6 Power Receptacles	Q, V	EUE2-HLOB-6000	2234.53							

Worksurface Power Modules — Flip Top

Hardwire — Double-Sided

Bezel Depth	Bezel Width	Cord Length	Trim Color	Port Color	Port	Port Configuration	Cutout	Number	Price	
							Code			
							Options			
8" (203mm)	5.31" (135mm)	12' (3658mm)	Clear Anodized	White	4	1 Power Receptacle, 1 Data Port, 1 Cable Bay	M, P	EUE2-HLOW-1012	\$ 1954.54	
						1 Power Receptacle, 3 Data Ports	M, P	EUE2-HLOW-1030	1954.54	
						1 Power Receptacle, 1 Smart USB-A+C Charging, 1 Cable Bay	M, P	EUE2-HLOW-1102	2058.06	
						1 Power Receptacle, 1 Smart USB-A+C Charging, 2 Data Ports	M, P	EUE2-HLOW-1120	2058.06	
						1 Power Receptacle, 3 Smart USB-A+C Charging	M, P	EUE2-HLOW-1300	2265.10	
						2 Power Receptacles, 1 Cable Bay	M, P	EUE2-HLOW-2002	1954.54	
						2 Power Receptacles, 2 Data Ports	M, P	EUE2-HLOW-2020	1954.54	
						2 Power Receptacles, 1 Smart USB-A+C Charging, 1 Data Port	M, P	EUE2-HLOW-2110	2058.06	
						2 Power Receptacles, 2 Smart USB-A+C Charging	M, P	EUE2-HLOW-2200	2161.58	
						3 Power Receptacles, 1 Data Port	M, P	EUE2-HLOW-3010	1954.54	
						3 Power Receptacles, 1 Smart USB-A+C Charging	M, P	EUE2-HLOW-3100	2058.06	
						4 Power Receptacles	M, P	EUE2-HLOW-4000	1954.54	
						6	1 Power Receptacle, 3 Data Ports, 1 Cable Bay	Q, V	EUE2-HLOW-1032	\$ 1954.54
							1 Power Receptacle, 5 Data Ports	Q, V	EUE2-HLOW-1050	1954.54
							1 Power Receptacle, 1 Smart USB-A+C Charging, 2 Data Ports, 1 Cable Bay	Q, V	EUE2-HLOW-1122	2058.06
					1 Power Receptacle, 1 Smart USB-A+C Charging, 4 Data Ports		Q, V	EUE2-HLOW-1140	2058.06	
					1 Power Receptacle, 2 Smart USB-A+C Charging, 1 Data Port, 1 Cable Bay		Q, V	EUE2-HLOW-1212	2161.58	
					1 Power Receptacle, 2 Smart USB-A+C Charging, 3 Data Ports		Q, V	EUE2-HLOW-1230	2161.58	
					1 Power Receptacle, 3 Smart USB-A+C Charging, 1 Cable Bay		Q, V	EUE2-HLOW-1302	2265.10	
					1 Power Receptacle, 3 Smart USB-A+C Charging, 2 Data Ports		Q, V	EUE2-HLOW-1320	2265.10	
					2 Power Receptacles, 2 Data Ports, 1 Cable Bay		Q, V	EUE2-HLOW-2022	1954.54	
					2 Power Receptacles, 4 Data Ports		Q, V	EUE2-HLOW-2040	1954.54	
					2 Power Receptacles, 1 Smart USB-A+C Charging, 1 Data Port, 1 Cable Bay		Q, V	EUE2-HLOW-2112	2058.06	
					2 Power Receptacles, 1 Smart USB-A+C Charging, 3 Data Ports		Q, V	EUE2-HLOW-2130	2058.06	
					2 Power Receptacles, 2 Smart USB-A+C Charging, 1 Cable Bay		Q, V	EUE2-HLOW-2202	2161.58	
					2 Power Receptacles, 2 Smart USB-A+C Charging, 2 Data Ports		Q, V	EUE2-HLOW-2220	2161.58	
					2 Power Receptacles, 3 Smart USB-A+C Charging, 1 Data Port		Q, V	EUE2-HLOW-2310	2265.10	
					2 Power Receptacles, 4 Smart USB-A+C Charging	Q, V	EUE2-HLOW-2400	2368.62		
					3 Power Receptacles, 1 Data Port, 1 Cable Bay	Q, V	EUE2-HLOW-3012	1954.54		
					3 Power Receptacles, 3 Data Ports	Q, V	EUE2-HLOW-3030	1954.54		
3 Power Receptacles, 1 Smart USB-A+C Charging, 1 Cable Bay	Q, V	EUE2-HLOW-3102	2058.06							
3 Power Receptacles, 1 Smart USB-A+C Charging, 2 Data Ports	Q, V	EUE2-HLOW-3120	2058.06							
3 Power Receptacles, 2 Smart USB-A+C Charging, 1 Data Port	Q, V	EUE2-HLOW-3210	2161.58							
3 Power Receptacles, 3 Smart USB-A+C Charging	Q, V	EUE2-HLOW-3300	2265.10							
4 Power Receptacles, 1 Cable Bay	Q, V	EUE2-HLOW-4002	1954.54							
4 Power Receptacles, 2 Data Ports	Q, V	EUE2-HLOW-4020	1954.54							
4 Power Receptacles, 1 Smart USB-A+C Charging, 1 Data Port	Q, V	EUE2-HLOW-4110	2058.06							
4 Power Receptacles, 2 Smart USB-A+C Charging	Q, V	EUE2-HLOW-4200	2161.58							
5 Power Receptacles, 1 Data Port	Q, V	EUE2-HLOW-5010	1954.54							
5 Power Receptacles, 1 Smart USB-A+C Charging	Q, V	EUE2-HLOW-5100	2058.06							
6 Power Receptacles	Q, V	EUE2-HLOW-6000	1954.54							

Worksurface Power Modules — Flush Mounted Power Corded

3-Port:

- (2) Power
- (1) Smart USB-A+C

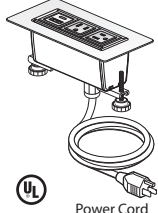

Power Cord

EUBI-PL0B-2100

4-Port:

- (2) Power
- (1) Smart USB-A+C
- (1) Data

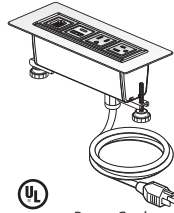

Power Cord

EUBI-PL0B-2110

6-Port:

- (2) Power
- (1) Smart USB-A+C
- (1) Data
- (1) Cable Bay

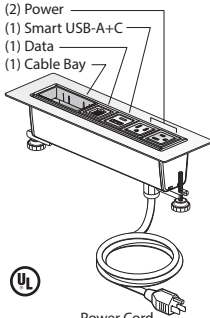

Power Cord

EUBI-PL0B-2112

4-Port:

- (4) Power

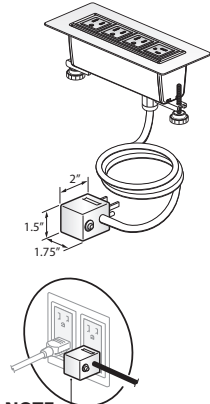

NOTE:

Always Circuit Breaker Plug when more than 3 power outlets specified.

EUBI-PL0B-4000

Class YA – GSA: Open Market

Features

- Includes power module with 3, 4 or 6 ports that can be configured with simplex outlets (NEMA-5-15R), USB charging port (Smart USB-A+C), data ports or cable bay(s) that can accept up to two pull out data/AV cables and mounting hardware.
- Data port accommodate most varieties of field supplied data/ AV jacks.
- Corded power module with 15 amp - 12'(3658mm) long cord with plug (NEMA 5-15P).
- The Smart USB-A+C allows for the 20W to be transferred between the 2 ports. If the USB-A is being used, the full wattage is sent to the USB-A, and the same for the USB-C. If both are being used, the wattage is distributed to each port and the port drawing the most power will receive more watts than the one that is not.
- Attaches to surface with use of included mounting brackets.
- Flush Mount has an overall housing depth of 4"(102mm) and will extend into mounting surface.
- Color option of black painted bezel with black receptacles or white painted bezel with white receptacles.

Specification Tips

- Designed to be used with 1.18"(30mm) and 2"(51mm) thick surfaces with clear space below.
- **Configuration and quantity of power and data ports cannot be modified in the field.**
- **For use with 120 volt 60 hertz power source only.**
- Requires field installation.
- Requires field cut access hole for power cord/conduit routing.
- Specify AV cables separately.
- Cable Bay requires cables less than 0.3"(8mm) diameter.
- Application may require approval of local authority having jurisdiction (AHJ); ensure compliance before placing orders and installation.

To Order, Specify:

- 1) Product number.
(No finish specification required.)

Worksurface Power Modules — Flush Mounted Power Corded

Top Depth	Top Width	Cord Length	Trim Color	Port Color	Port	Configuration	Number	Price						
Corded														
3"(76mm)	6.75"(171mm)	12'(3658mm)	Black	Black	3	1 Power Receptacle, 1 Cable Bay	EUB1-PL0B-1002	\$ 949.68						
						1 Power Receptacle, 2 Data Ports	EUB1-PL0B-1020	949.68						
						1 Power Receptacle, 1 Data Port, 1 Smart USB-A+C Charging	EUB1-PL0B-1110	1053.50						
						1 Power Receptacle, 2 Smart USB-A+C Charging	EUB1-PL0B-1200	1157.32						
						2 Power Receptacles, 1 Data Port	EUB1-PL0B-2010	949.68						
						2 Power Receptacles, 1 Smart USB-A+C Charging	EUB1-PL0B-2100	1053.50						
						3 Power Receptacles	EUB1-PL0B-3000	949.68						
3"(76mm)	8.25"(210mm)				4	1 Power Receptacle, 1 Data Port, 1 Cable Bay	EUB1-PL0B-1012	\$1039.64						
						1 Power Receptacle, 3 Data Ports	EUB1-PL0B-1030	1039.64						
						1 Power Receptacle, 1 Smart USB-A+C Charging, 1 Cable Bay	EUB1-PL0B-1102	1143.46						
						1 Power Receptacle, 3 Smart USB-A+C Charging	EUB1-PL0B-1300	1351.10						
						2 Power Receptacles, 1 Cable Bay	EUB1-PL0B-2002	1039.64						
						2 Power Receptacles, 2 Data Ports	EUB1-PL0B-2020	1039.64						
						2 Power Receptacles, 1 Smart USB-A+C Charging, 1 Data Port	EUB1-PL0B-2110	1143.46						
						2 Power Receptacles, 2 Smart USB-A+C Charging	EUB1-PL0B-2200	1247.28						
						3 Power Receptacles, 1 Data Port	EUB1-PL0B-3010	1039.64						
						3 Power Receptacles, 1 Smart USB-A+C Charging	EUB1-PL0B-3100	1143.46						
						4 Power Receptacles	EUB1-PL0B-4000	1039.64						
						3"(76mm)	9.75"(248mm)				6	1 Power Receptacle, 1 Smart USB-A+C Charging, 2 Cable Bays	EUB1-PL0B-1104	\$1233.48
												1 Power Receptacle, 1 Smart USB-A+C Charging, 2 Data Ports, 1 Cable Bay	EUB1-PL0B-1122	1233.48
1 Power Receptacle, 1 Smart USB-A+C Charging, 4 Data Ports	EUB1-PL0B-1140	1233.48												
1 Power Receptacle, 2 Smart USB-A+C Charging, 1 Data Port, 1 Cable Bay	EUB1-PL0B-1212	1337.30												
1 Power Receptacle, 2 Smart USB-A+C Charging, 3 Data Ports	EUB1-PL0B-1230	1337.30												
1 Power Receptacle, 3 Smart USB-A+C Charging, 1 Cable Bay	EUB1-PL0B-1302	1441.12												
1 Power Receptacle, 3 Smart USB-A+C Charging, 2 Data Ports	EUB1-PL0B-1320	1441.12												
1 Power Receptacle, 4 Smart USB-A+C Charging, 1 Data Port	EUB1-PL0B-1410	1544.94												
2 Power Receptacles, 2 Cable Bays	EUB1-PL0B-2004	1129.66												
2 Power Receptacles, 2 Data Ports, 1 Cable Bay	EUB1-PL0B-2022	1129.66												
2 Power Receptacles, 4 Data Ports	EUB1-PL0B-2040	1129.66												
2 Power Receptacles, 1 Smart USB-A+C Charging, 1 Data Port, 1 Cable Bay	EUB1-PL0B-2112	1233.48												
2 Power Receptacles, 1 Smart USB-A+C Charging, 3 Data Ports	EUB1-PL0B-2130	1233.48												
2 Power Receptacles, 2 Smart USB-A+C Charging, 1 Cable Bay	EUB1-PL0B-2202	1337.30												
2 Power Receptacles, 2 Smart USB-A+C Charging, 2 Data Ports	EUB1-PL0B-2220	1337.30												
2 Power Receptacles, 3 Smart USB-A+C Charging, 1 Data Port	EUB1-PL0B-2310	1441.12												
2 Power Receptacles, 4 Smart USB-A+C Charging	EUB1-PL0B-2400	1544.94												
3 Power Receptacles, 3 Data Ports	EUB1-PL0B-3030	1129.66												
3 Power Receptacles, 1 Smart USB-A+C Charging, 1 Cable Bay	EUB1-PL0B-3102	1233.48												
3 Power Receptacles, 1 Smart USB-A+C Charging, 2 Data Ports	EUB1-PL0B-3120	1233.48												
3 Power Receptacles, 2 Smart USB-A+C Charging, 1 Data Port	EUB1-PL0B-3210	1337.30												
3 Power Receptacles, 3 Smart USB-A+C Charging	EUB1-PL0B-3300	1441.12												
4 Power Receptacles, 1 Cable Bay	EUB1-PL0B-4002	1129.66												
4 Power Receptacles, 2 Data Ports	EUB1-PL0B-4020	1129.66												
4 Power Receptacles, 1 Smart USB-A+C Charging, 1 Data Port	EUB1-PL0B-4110	1233.48												
4 Power Receptacles, 2 Smart USB-A+C Charging	EUB1-PL0B-4200	1337.30												
5 Power Receptacles, 1 Data Port	EUB1-PL0B-5010	1129.66												
5 Power Receptacles, 1 Smart USB-A+C Charging	EUB1-PL0B-5100	1233.48												
6 Power Receptacles	EUB1-PL0B-6000	1129.66												

Worksurface Power Modules — Flush Mounted Power Corded

Top Depth	Top Width	Cord Length	Trim Color	Port Color	Port	Port Configuration	Number	Price
3"(76mm)	6.75"(171mm)	12'(3658mm)	White	White	3	1 Power Receptacle, 1 Cable Bay	EUB1-PLow-1002	\$ 949.68
						1 Power Receptacle, 2 Data Ports	EUB1-PLow-1020	949.68
						1 Power Receptacle, 1 Data Port, 1 Smart USB-A+C Charging	EUB1-PLow-1110	1053.50
						1 Power Receptacle, 2 Smart USB-A+C Charging	EUB1-PLow-1200	1157.32
						2 Power Receptacles, 1 Data Port	EUB1-PLow-2010	949.68
						2 Power Receptacles, 1 Smart USB-A+C Charging	EUB1-PLow-2100	1053.50
3"(76mm)	8.25"(210mm)				4	3 Power Receptacles	EUB1-PLow-3000	949.68
						1 Power Receptacle, 1 Data Port, 1 Cable Bay	EUB1-PLow-1012	\$1039.64
						1 Power Receptacle, 3 Data Ports	EUB1-PLow-1030	1039.64
						1 Power Receptacle, 1 Smart USB-A+C Charging, 1 Cable Bay	EUB1-PLow-1102	1143.46
						1 Power Receptacle, 3 Smart USB-A+C Charging	EUB1-PLow-1300	1351.10
						2 Power Receptacles, 1 Cable Bay	EUB1-PLow-2002	1039.64
						2 Power Receptacles, 2 Data Ports	EUB1-PLow-2020	1039.64
						2 Power Receptacles, 1 Smart USB-A+C Charging, 1 Data Port	EUB1-PLow-2110	1143.46
						2 Power Receptacles, 2 Smart USB-A+C Charging	EUB1-PLow-2200	1247.28
						3 Power Receptacles, 1 Data Port	EUB1-PLow-3010	1039.64
3"(76mm)	9.75"(248mm)				6	3 Power Receptacles, 1 Smart USB-A+C Charging	EUB1-PLow-3100	1143.46
						4 Power Receptacles	EUB1-PLow-4000	1039.64
						1 Power Receptacle, 1 Smart USB-A+C Charging, 2 Cable Bays	EUB1-PLow-1104	\$1233.48
						1 Power Receptacle, 1 Smart USB-A+C Charging, 2 Data Ports, 1 Cable Bay	EUB1-PLow-1122	1233.48
						1 Power Receptacle, 1 Smart USB-A+C Charging, 4 Data Ports	EUB1-PLow-1140	1233.48
						1 Power Receptacle, 2 Smart USB-A+C Charging, 1 Data Port, 1 Cable Bay	EUB1-PLow-1212	1337.30
						1 Power Receptacle, 2 Smart USB-A+C Charging, 3 Data Ports	EUB1-PLow-1230	1337.30
						1 Power Receptacle, 3 Smart USB-A+C Charging, 1 Cable Bay	EUB1-PLow-1302	1441.12
						1 Power Receptacle, 3 Smart USB-A+C Charging, 2 Data Ports	EUB1-PLow-1320	1441.12
						1 Power Receptacle, 4 Smart USB-A+C Charging, 1 Data Port	EUB1-PLow-1410	1544.94
						2 Power Receptacles, 2 Cable Bays	EUB1-PLow-2004	1129.66
						2 Power Receptacles, 2 Data Ports, 1 Cable Bay	EUB1-PLow-2022	1129.66
						2 Power Receptacles, 4 Data Ports	EUB1-PLow-2040	1129.66
						2 Power Receptacles, 1 Smart USB-A+C Charging, 1 Data Port, 1 Cable Bay	EUB1-PLow-2112	1233.48
						2 Power Receptacles, 1 Smart USB-A+C Charging, 3 Data Ports	EUB1-PLow-2130	1233.48
						2 Power Receptacles, 2 Smart USB-A+C Charging, 1 Cable Bay	EUB1-PLow-2202	1337.30
						2 Power Receptacles, 2 Smart USB-A+C Charging, 2 Data Ports	EUB1-PLow-2220	1337.30
						2 Power Receptacles, 3 Smart USB-A+C Charging, 1 Data Port	EUB1-PLow-2310	1441.12
2 Power Receptacles, 4 Smart USB-A+C Charging	EUB1-PLow-2400	1544.94						
						3 Power Receptacles, 3 Data Ports	EUB1-PLow-3030	1129.66
						3 Power Receptacles, 1 Smart USB-A+C Charging, 1 Cable Bay	EUB1-PLow-3102	1233.48
						3 Power Receptacles, 1 Smart USB-A+C Charging, 2 Data Ports	EUB1-PLow-3120	1233.48
						3 Power Receptacles, 2 Smart USB-A+C Charging, 1 Data Port	EUB1-PLow-3210	1337.30
						3 Power Receptacles, 3 Smart USB-A+C Charging	EUB1-PLow-3300	1441.12
						4 Power Receptacles, 1 Cable Bay	EUB1-PLow-4002	1129.66
						4 Power Receptacles, 2 Data Ports	EUB1-PLow-4020	1129.66
						4 Power Receptacles, 1 Smart USB-A+C Charging, 1 Data Port	EUB1-PLow-4110	1233.48
						4 Power Receptacles, 2 Smart USB-A+C Charging	EUB1-PLow-4200	1337.30
						5 Power Receptacles, 1 Data Port	EUB1-PLow-5010	1129.66
5 Power Receptacles, 1 Smart USB-A+C Charging	EUB1-PLow-5100	1233.48						
						6 Power Receptacles	EUB1-PLow-6000	1129.66

Worksurface Power Modules — Flush Mounted Power Hardware

3-Port:

- (2) Power
- (1) Smart USB-A+C

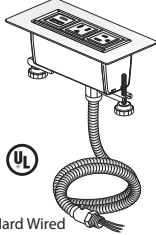

Hard Wired

EUBI-HLOB-2100

4-Port:

- (2) Power
- (1) Smart USB-A+C
- (1) Data

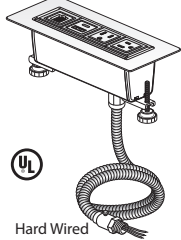

Hard Wired

EUBI-HLOB-2110

6-Port:

- (2) Power
- (1) Smart USB-A+C
- (1) Data
- (1) Cable Bay

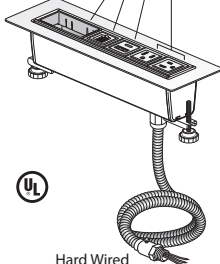

Hard Wired

EUBI-HLOB-2112

Class YA – GSA: Open Market

Features

- Includes power module with 3, 4 or 6 ports that can be configured with simplex outlets (NEMA-5-15R), USB charging port (Smart USB-A+C), data ports or cable bay(s) that can accept up to two pull out data/AV cables and mounting hardware.
- Data port accommodate most varieties of field supplied data/ AV jacks.
- Hardwired power module with 12'(3658mm) long flexible metal conduit feed, 0.5"(13mm) conduit fitting and wires for hardwire connection.
- The Smart USB-A+C allows for the 20W to be transferred between the 2 ports. If the USB-A is being used, the full wattage is sent to the USB-A, and the same for the USB-C. If both are being used, the wattage is distributed to each port and the port drawing the most power will receive more watts than the one that is not.
- Attaches to surface with use of included mounting brackets.
- Flush Mount has an overall housing depth of 4"(102mm) and will extend into mounting surface.
- Color option of black painted bezel with black receptacles or white painted bezel with white receptacles.

Specification Tips

- Designed to be used with 1.18"(30mm) and 2"(51mm) thick surfaces with clear space below.
- **Configuration and quantity of power and data ports cannot be modified in the field.**
- **For use with 120 volt 60 hertz power source only.**
- Requires field installation.
- Requires field cut access hole for power cord/conduit routing.
- Specify AV cables separately.
- Cable Bay requires cables less than 0.3"(8mm) diameter.
- Application may require approval of local authority having jurisdiction (AHJ); ensure compliance before placing orders and installation.

To Order, Specify:

- 1) Product number.
(No finish specification required.)

Worksurface Power Modules — Flush Mounted Power Hardware

Top Depth	Top Width	Conduit Length	Trim Color	Port Color	Port	Power	USB Charging	Data Port	Cable Bay	Description	Number	Price
Corded												
3" (76mm)	6.75" (171mm)	12' (3658mm)	Black	Black	3	1	0	0	2	1 Power Receptacle, 1 Cable Bay	EUBI-HLOB-1002	\$1069.86
						1	0	2	0	1 Power Receptacle, 2 Data Ports	EUBI-HLOB-1020	1069.86
						1	1	1	0	1 Power Receptacle, 1 Data Port, 1 Smart USB-A+C Charging	EUBI-HLOB-1110	1173.68
						1	2	0	0	1 Power Receptacle, 2 Smart USB-A+C Charging	EUBI-HLOB-1200	1277.50
						2	0	1	0	2 Power Receptacles, 1 Data Port	EUBI-HLOB-2010	1069.86
						2	1	0	0	2 Power Receptacles, 1 Smart USB-A+C Charging	EUBI-HLOB-2100	1173.68
						3	0	0	0	3 Power Receptacles	EUBI-HLOB-3000	1069.86
3" (76mm)	8.25" (210mm)				4	1	0	1	2	1 Power Receptacle, 1 Data Port, 1 Cable Bay	EUBI-HLOB-1012	\$ 1159.82
						1	0	3	0	1 Power Receptacle, 3 Data Ports	EUBI-HLOB-1030	1159.82
						1	1	0	2	1 Power Receptacle, 1 Smart USB-A+C Charging, 1 Cable Bay	EUBI-HLOB-1102	1263.64
						1	3	0	0	1 Power Receptacle, 3 Smart USB-A+C Charging	EUBI-HLOB-1300	1471.28
						2	0	0	2	2 Power Receptacles, 1 Cable Bay	EUBI-HLOB-2002	1159.82
						2	0	2	0	2 Power Receptacles, 2 Data Ports	EUBI-HLOB-2020	1159.82
						2	1	1	0	2 Power Receptacles, 1 Smart USB-A+C Charging, 1 Data Port	EUBI-HLOB-2110	1263.64
						2	2	0	0	2 Power Receptacles, 2 Smart USB-A+C Charging	EUBI-HLOB-2200	1367.46
						3	0	1	0	3 Power Receptacles, 1 Data Port	EUBI-HLOB-3010	1159.82
						3	1	0	0	3 Power Receptacles, 1 Smart USB-A+C Charging	EUBI-HLOB-3100	1263.64
						4	0	0	0	4 Power Receptacles	EUBI-HLOB-4000	1159.82
3" (76mm)	9.75" (248mm)				6	1	1	0	4	1 Power Receptacle, 1 Smart USB-A+C Charging, 2 Cable Bays	EUBI-HLOB-1104	\$1353.66
						1	1	2	2	1 Power Receptacle, 1 Smart USB-A+C Charging, 2 Data Ports, 1 Cable Bay	EUBI-HLOB-1122	1353.66
						1	1	4	0	1 Power Receptacle, 1 Smart USB-A+C Charging, 4 Data Ports	EUBI-HLOB-1140	1353.66
						1	2	1	2	1 Power Receptacle, 2 Smart USB-A+C Charging, 1 Data Port, 1 Cable Bay	EUBI-HLOB-1212	1457.48
						1	2	3	0	1 Power Receptacle, 2 Smart USB-A+C Charging, 3 Data Ports	EUBI-HLOB-1230	1457.48
						1	3	0	2	1 Power Receptacle, 3 Smart USB-A+C Charging, 1 Cable Bay	EUBI-HLOB-1302	1561.30
						1	3	2	0	1 Power Receptacle, 3 Smart USB-A+C Charging, 2 Data Ports	EUBI-HLOB-1320	1561.30
						1	4	1	0	1 Power Receptacle, 4 Smart USB-A+C Charging, 1 Data Port	EUBI-HLOB-1410	1665.12
						2	0	0	4	2 Power Receptacles, 2 Cable Bays	EUBI-HLOB-2004	1249.84
						2	0	2	2	2 Power Receptacles, 2 Data Ports, 1 Cable Bay	EUBI-HLOB-2022	1249.84
						2	0	4	0	2 Power Receptacles, 4 Data Ports	EUBI-HLOB-2040	1249.84
						2	1	1	2	2 Power Receptacles, 1 Smart USB-A+C Charging, 1 Data Port, 1 Cable Bay	EUBI-HLOB-2112	1353.66
						2	1	3	0	2 Power Receptacles, 1 Smart USB-A+C Charging, 3 Data Ports	EUBI-HLOB-2130	1353.66
						2	2	0	2	2 Power Receptacles, 2 Smart USB-A+C Charging, 1 Cable Bay	EUBI-HLOB-2202	1457.48
						2	2	2	0	2 Power Receptacles, 2 Smart USB-A+C Charging, 2 Data Ports	EUBI-HLOB-2220	1457.48
						2	3	1	0	2 Power Receptacles, 3 Smart USB-A+C Charging, 1 Data Port	EUBI-HLOB-2310	1561.30
						2	4	0	0	2 Power Receptacles, 4 Smart USB-A+C Charging	EUBI-HLOB-2400	1665.12
						3	0	3	0	3 Power Receptacles, 3 Data Ports	EUBI-HLOB-3030	1249.84
						3	1	0	2	3 Power Receptacles, 1 Smart USB-A+C Charging, 1 Cable Bay	EUBI-HLOB-3102	1353.66
						3	1	2	0	3 Power Receptacles, 1 Smart USB-A+C Charging, 2 Data Ports	EUBI-HLOB-3120	1353.66
						3	2	1	0	3 Power Receptacles, 2 Smart USB-A+C Charging, 1 Data Port	EUBI-HLOB-3210	1457.48
						3	3	0	0	3 Power Receptacles, 3 Smart USB-A+C Charging	EUBI-HLOB-3300	1561.30
						4	0	0	2	4 Power Receptacles, 1 Cable Bay	EUBI-HLOB-4002	1249.84
						4	0	2	0	4 Power Receptacles, 2 Data Ports	EUBI-HLOB-4020	1249.84
						4	1	1	0	4 Power Receptacles, 1 Smart USB-A+C Charging, 1 Data Port	EUBI-HLOB-4110	1353.66
						4	2	0	0	4 Power Receptacles, 2 Smart USB-A+C Charging	EUBI-HLOB-4200	1457.48
						5	0	1	0	5 Power Receptacles, 1 Data Port	EUBI-HLOB-5010	1249.84
						5	1	0	0	5 Power Receptacles, 1 Smart USB-A+C Charging	EUBI-HLOB-5100	1353.66
						6	0	0	0	6 Power Receptacles	EUBI-HLOB-6000	1249.84

Worksurface Power Modules — Flush Mounted Power Hardware

Top Depth	Top Width	Conduit Length	Trim Color	Port Color	Port	Power	USB Charging	Data Port	Cable Bay	Description	Number	Price
3" (76mm)	6.75" (171mm)	12' (3658mm)	White	White	3	1	0	0	2	1 Power Receptacle, 1 Cable Bay	EUB1-HLOW-1002	\$1069.86
						1	0	2	0	1 Power Receptacle, 2 Data Ports	EUB1-HLOW-1020	1069.86
						1	1	1	0	1 Power Receptacle, 1 Data Port, 1 Smart USB-A+C Charging	EUB1-HLOW-1110	1173.68
						1	2	0	0	1 Power Receptacle, 2 Smart USB-A+C Charging	EUB1-HLOW-1200	1277.50
						2	0	1	0	2 Power Receptacles, 1 Data Port	EUB1-HLOW-2010	1069.86
						2	1	0	0	2 Power Receptacles, 1 Smart USB-A+C Charging	EUB1-HLOW-2100	1173.68
						3	0	0	0	3 Power Receptacles	EUB1-HLOW-3000	1069.86
3" (76mm)	8.25" (210mm)				4	1	0	1	2	1 Power Receptacle, 1 Data Port, 1 Cable Bay	EUB1-HLOW-1012	\$ 1159.82
						1	0	3	0	1 Power Receptacle, 3 Data Ports	EUB1-HLOW-1030	1159.82
						1	1	0	2	1 Power Receptacle, 1 Smart USB-A+C Charging, 1 Cable Bay	EUB1-HLOW-1102	1263.64
						1	3	0	0	1 Power Receptacle, 3 Smart USB-A+C Charging	EUB1-HLOW-1300	1471.28
						2	0	0	2	2 Power Receptacles, 1 Cable Bay	EUB1-HLOW-2002	1159.82
						2	0	2	0	2 Power Receptacles, 2 Data Ports	EUB1-HLOW-2020	1159.82
						2	1	1	0	2 Power Receptacles, 1 Smart USB-A+C Charging, 1 Data Port	EUB1-HLOW-2110	1263.64
						2	2	0	0	2 Power Receptacles, 2 Smart USB-A+C Charging	EUB1-HLOW-2200	1367.46
						3	0	1	0	3 Power Receptacles, 1 Data Port	EUB1-HLOW-3010	1159.82
						3	1	0	0	3 Power Receptacles, 1 Smart USB-A+C Charging	EUB1-HLOW-3100	1263.64
						4	0	0	0	4 Power Receptacles	EUB1-HLOW-4000	1159.82
3" (76mm)	9.75" (248mm)				6	1	1	0	4	1 Power Receptacle, 1 Smart USB-A+C Charging, 2 Cable Bays	EUB1-HLOW-1104	\$1353.66
						1	1	2	2	1 Power Receptacle, 1 Smart USB-A+C Charging, 2 Data Ports, 1 Cable Bay	EUB1-HLOW-1122	1353.66
						1	1	4	0	1 Power Receptacle, 1 Smart USB-A+C Charging, 4 Data Ports	EUB1-HLOW-1140	1353.66
						1	2	1	2	1 Power Receptacle, 2 Smart USB-A+C Charging, 1 Data Port, 1 Cable Bay	EUB1-HLOW-1212	1457.48
						1	2	3	0	1 Power Receptacle, 2 Smart USB-A+C Charging, 3 Data Ports	EUB1-HLOW-1230	1457.48
						1	3	0	2	1 Power Receptacle, 3 Smart USB-A+C Charging, 1 Cable Bay	EUB1-HLOW-1302	1561.30
						1	3	2	0	1 Power Receptacle, 3 Smart USB-A+C Charging, 2 Data Ports	EUB1-HLOW-1320	1561.30
						1	4	1	0	1 Power Receptacle, 4 Smart USB-A+C Charging, 1 Data Port	EUB1-HLOW-1410	1665.12
						2	0	0	4	2 Power Receptacles, 2 Cable Bays	EUB1-HLOW-2004	1249.84
						2	0	2	2	2 Power Receptacles, 2 Data Ports, 1 Cable Bay	EUB1-HLOW-2022	1249.84
						2	0	4	0	2 Power Receptacles, 4 Data Ports	EUB1-HLOW-2040	1249.84
						2	1	1	2	2 Power Receptacles, 1 Smart USB-A+C Charging, 1 Data Port, 1 Cable Bay	EUB1-HLOW-2112	1353.66
						2	1	3	0	2 Power Receptacles, 1 Smart USB-A+C Charging, 3 Data Ports	EUB1-HLOW-2130	1353.66
						2	2	0	2	2 Power Receptacles, 2 Smart USB-A+C Charging, 1 Cable Bay	EUB1-HLOW-2202	1457.48
						2	2	2	0	2 Power Receptacles, 2 Smart USB-A+C Charging, 2 Data Ports	EUB1-HLOW-2220	1457.48
						2	3	1	0	2 Power Receptacles, 3 Smart USB-A+C Charging, 1 Data Port	EUB1-HLOW-2310	1561.30
						2	4	0	0	2 Power Receptacles, 4 Smart USB-A+C Charging	EUB1-HLOW-2400	1665.12
						3	0	3	0	3 Power Receptacles, 3 Data Ports	EUB1-HLOW-3030	1249.84
						3	1	0	2	3 Power Receptacles, 1 Smart USB-A+C Charging, 1 Cable Bay	EUB1-HLOW-3102	1353.66
						3	1	2	0	3 Power Receptacles, 1 Smart USB-A+C Charging, 2 Data Ports	EUB1-HLOW-3120	1353.66
						3	2	1	0	3 Power Receptacles, 2 Smart USB-A+C Charging, 1 Data Port	EUB1-HLOW-3210	1457.48
						3	3	0	0	3 Power Receptacles, 3 Smart USB-A+C Charging	EUB1-HLOW-3300	1561.30
						4	0	0	2	4 Power Receptacles, 1 Cable Bay	EUB1-HLOW-4002	1249.84
						4	0	2	0	4 Power Receptacles, 2 Data Ports	EUB1-HLOW-4020	1249.84
						4	1	1	0	4 Power Receptacles, 1 Smart USB-A+C Charging, 1 Data Port	EUB1-HLOW-4110	1353.66
						4	2	0	0	4 Power Receptacles, 2 Smart USB-A+C Charging	EUB1-HLOW-4200	1457.48
						5	0	1	0	5 Power Receptacles, 1 Data Port	EUB1-HLOW-5010	1249.84
						5	1	0	0	5 Power Receptacles, 1 Smart USB-A+C Charging	EUB1-HLOW-5100	1353.66
						6	0	0	0	6 Power Receptacles	EUB1-HLOW-6000	1249.84

Worksurface Power Modules — Flush Mounted Power Spiral Cord for Height Adjustable

3-Port:

- (2) Power
- (1) Smart USB-A+C

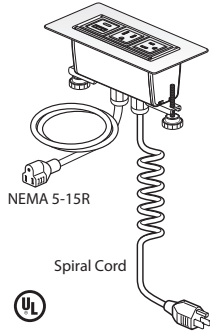

EUB1-SFOB-2100

4-Port:

- (2) Power
- (1) Smart USB-A+C
- (1) Data

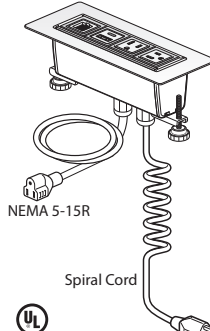

EUB1-SFOB-2110

6-Port:

- (2) Power
- (1) Smart USB-A+C
- (1) Data
- (1) Cable Bay

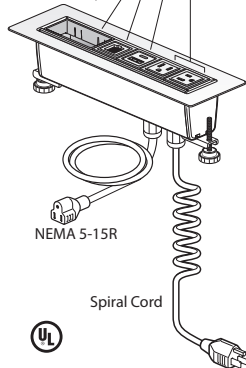

EUB1-SFOB-2112

Class YA – GSA: Open Market

Features

- Includes power module with 3, 4 or 6 ports that can be configured with simplex outlets (NEMA-5-15R), USB charging port (Smart USB-A+C), data ports or cable bay(s) that can accept up to two pull out data/AV cables and mounting hardware.
- Data port accommodate most varieties of field supplied data/ AV jacks.
- Spiral Cord includes 15 amp plug (NEMA 5-15P) and expands to 12'(3658mm) when stretched.
- Auxiliary 24"(610mm) power cord with NEMA 5-15R used to provide power to table motor controller.
- The Smart USB-A+C allows for the 20W to be transferred between the 2 ports. If the USB-A is being used, the full wattage is sent to the USB-A, and the same for the USB-C. If both are being used, the wattage is distributed to each port and the port drawing the most power will receive more watts than the one that is not.
- Attaches to surface with use of included mounting brackets.
- Flush Mount has an overall housing depth of 4"(102mm) and will extend into mounting surface.
- Color option of black painted bezel with black receptacles or white painted bezel with white receptacles.

Specification Tips

- **Configuration and quantity of power and data ports cannot be modified in the field.**
- **For use with 120 volt 60 hertz power source only.**
- **For use with Height Adjustable Tables or Benching.**
- Not for use with cable chain.
- Requires field installation.
- Requires field cut access hole for power cord/conduit routing.
- Specify AV cables separately.
- Cable Bay requires cables less than 0.3"(8mm) diameter.
- Application may require approval of local authority having jurisdiction (AHJ); ensure compliance before placing orders and installation.

4-Port:

- (4) Power

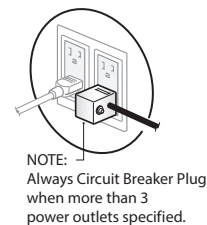
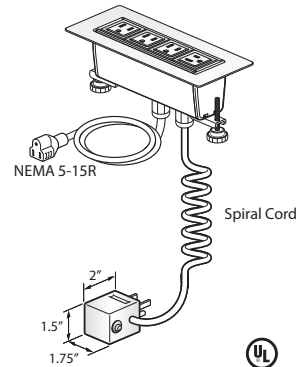

EUB1-SFOB-4000

To Order, Specify:

- 1) Product number.
(No finish specification required.)

Worksurface Power Modules — Flush Mounted Power Spiral Cord for Height Adjustable

Top Depth	Top Width	Cord Length	Trim Color	Port Color	Port	Configuration	Number	Price
Corded								
3"(76mm)	6.75"(171mm)	10'(3048mm)	Black	Black	3	2 Power Receptacles, 1 Data Port	EUBI-SFOB-2010	\$1252.04
						2 Power Receptacles, 1 Smart USB-A+C Charging	EUBI-SFOB-2100	1355.86
						3 Power Receptacles	EUBI-SFOB-3000	1252.04
3"(76mm)	8.25"(210mm)				4	2 Power Receptacles, 1 Cable Bay	EUBI-SFOB-2002	1342.00
						2 Power Receptacles, 2 Data Ports	EUBI-SFOB-2020	1342.00
						2 Power Receptacles, 1 Smart USB-A+C Charging, 1 Data Port	EUBI-SFOB-2110	1445.82
						2 Power Receptacles, 2 Smart USB-A+C Charging	EUBI-SFOB-2200	1549.64
						3 Power Receptacles, 1 Data Port	EUBI-SFOB-3010	1342.00
						3 Power Receptacles, 1 Smart USB-A+C Charging	EUBI-SFOB-3100	1445.82
						4 Power Receptacles	EUBI-SFOB-4000	1342.00
3"(76mm)	9.75"(248mm)				6	2 Power Receptacles, 2 Cable Bays	EUBI-SFOB-2004	\$1432.02
						2 Power Receptacles, 2 Data Ports, 1 Cable Bay	EUBI-SFOB-2022	1432.02
						2 Power Receptacles, 4 Data Ports	EUBI-SFOB-2040	1432.02
						2 Power Receptacles, 1 Smart USB-A+C Charging, 1 Data Port, 1 Cable Bay	EUBI-SFOB-2112	1535.84
						2 Power Receptacles, 1 Smart USB-A+C Charging, 3 Data Ports	EUBI-SFOB-2130	1535.84
						2 Power Receptacles, 2 Smart USB-A+C Charging, 1 Cable Bay	EUBI-SFOB-2202	1639.66
						2 Power Receptacles, 2 Smart USB-A+C Charging, 2 Data Ports	EUBI-SFOB-2220	1639.66
						2 Power Receptacles, 3 Smart USB-A+C Charging, 1 Data Port	EUBI-SFOB-2310	1743.48
						2 Power Receptacles, 4 Smart USB-A+C Charging	EUBI-SFOB-2400	1847.30
						3 Power Receptacles, 1 Smart USB-A+C Charging, 1 Cable Bay	EUBI-SFOB-3012	1432.02
						3 Power Receptacles, 3 Data Ports	EUBI-SFOB-3030	1432.02
						3 Power Receptacles, 1 Smart USB-A+C Charging, 1 Cable Bay	EUBI-SFOB-3102	1535.84
						3 Power Receptacles, 1 Smart USB-A+C Charging, 2 Data Ports	EUBI-SFOB-3120	1535.84
						3 Power Receptacles, 2 Smart USB-A+C Charging, 1 Data Port	EUBI-SFOB-3210	1639.66
						3 Power Receptacles, 3 Smart USB-A+C Charging	EUBI-SFOB-3300	1743.48
						4 Power Receptacles, 1 Cable Bay	EUBI-SFOB-4002	1432.02
4 Power Receptacles, 2 Data Ports	EUBI-SFOB-4020	1432.02						
4 Power Receptacles, 1 Smart USB-A+C Charging, 1 Data Port	EUBI-SFOB-4110	1535.84						
4 Power Receptacles, 2 Smart USB-A+C Charging	EUBI-SFOB-4200	1639.66						
5 Power Receptacles, 1 Data Port	EUBI-SFOB-5010	1432.02						
5 Power Receptacles, 1 Smart USB-A+C Charging	EUBI-SFOB-5100	1535.84						
6 Power Receptacles	EUBI-SFOB-6000	1432.02						

Worksurface Power Modules — Flush Mounted Power Spiral Cord for Height Adjustable

Top Depth	Top Width	Cord Length	Trim Color	Port Color	Port	Configuration	Number	Price
3"(76mm)	6.75"(171mm)	10'(3048mm)	White	White	3	2 Power Receptacles, 1 Data Port	EUBI-SFOW-2010	\$1252.04
						2 Power Receptacles, 1 Smart USB-A+C Charging	EUBI-SFOW-2100	1355.86
						3 Power Receptacles	EUBI-SFOW-3000	1252.04
3"(76mm)	8.25"(210mm)				4	2 Power Receptacles, 1 Cable Bay	EUBI-SFOW-2002	\$1342.00
						2 Power Receptacles, 2 Data Ports	EUBI-SFOW-2020	1342.00
						2 Power Receptacles, 1 Smart USB-A+C Charging, 1 Data Port	EUBI-SFOW-2110	1445.82
						2 Power Receptacles, 2 Smart USB-A+C Charging	EUBI-SFOW-2200	1549.64
						3 Power Receptacles, 1 Data Port	EUBI-SFOW-3010	1342.00
						3 Power Receptacles, 1 Smart USB-A+C Charging	EUBI-SFOW-3100	1445.82
						4 Power Receptacles	EUBI-SFOW-4000	1342.00
3"(76mm)	9.75"(248mm)				6	2 Power Receptacles, 2 Cable Bays	EUBI-SFOW-2004	\$1432.02
						2 Power Receptacles, 2 Data Ports, 1 Cable Bay	EUBI-SFOW-2022	1432.02
						2 Power Receptacles, 4 Data Ports	EUBI-SFOW-2040	1432.02
						2 Power Receptacles, 1 Smart USB-A+C Charging, 1 Data Port, 1 Cable Bay	EUBI-SFOW-2112	1535.84
						2 Power Receptacles, 1 Smart USB-A+C Charging, 3 Data Ports	EUBI-SFOW-2130	1535.84
						2 Power Receptacles, 2 Smart USB-A+C Charging, 1 Cable Bay	EUBI-SFOW-2202	1639.66
						2 Power Receptacles, 2 Smart USB-A+C Charging, 2 Data Ports	EUBI-SFOW-2220	1639.66
						2 Power Receptacles, 3 Smart USB-A+C Charging, 1 Data Port	EUBI-SFOW-2310	1743.48
						2 Power Receptacles, 4 Smart USB-A+C Charging	EUBI-SFOW-2400	1847.30
						3 Power Receptacles, 1 Smart USB-A+C Charging, 1 Cable Bay	EUBI-SFOW-3012	1432.02
						3 Power Receptacles, 3 Data Ports	EUBI-SFOW-3030	1432.02
						3 Power Receptacles, 1 Smart USB-A+C Charging, 1 Cable Bay	EUBI-SFOW-3102	1535.84
						3 Power Receptacles, 1 Smart USB-A+C Charging, 2 Data Ports	EUBI-SFOW-3120	1535.84
						3 Power Receptacles, 2 Smart USB-A+C Charging, 1 Data Port	EUBI-SFOW-3210	1639.66
						3 Power Receptacles, 3 Smart USB-A+C Charging	EUBI-SFOW-3300	1743.48
						4 Power Receptacles, 1 Cable Bay	EUBI-SFOW-4002	1432.02
						4 Power Receptacles, 2 Data Ports	EUBI-SFOW-4020	1432.02
4 Power Receptacles, 1 Smart USB-A+C Charging, 1 Data Port	EUBI-SFOW-4110	1535.84						
4 Power Receptacles, 2 Smart USB-A+C Charging	EUBI-SFOW-4200	1639.66						
5 Power Receptacles, 1 Data Port	EUBI-SFOW-5010	1432.02						
5 Power Receptacles, 1 Smart USB-A+C Charging	EUBI-SFOW-5100	1535.84						
6 Power Receptacles	EUBI-SFOW-6000	1432.02						

Worksurface Power Modules — Flush Mounted Power Cord for Height Adjustable

3-Port:

- (2) Power
- (1) Smart USB-A+C

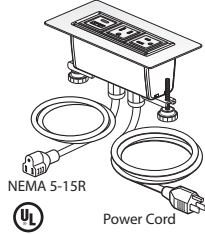

EUBI-SLOB-2100

4-Port:

- (2) Power
- (1) Smart USB-A+C
- (1) Data

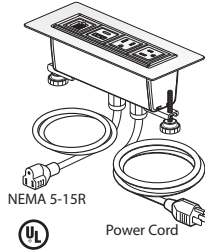

EUBI-SLOB-2110

6-Port:

- (2) Power
- (1) Smart USB-A+C
- (1) Data
- (1) Cable Bay

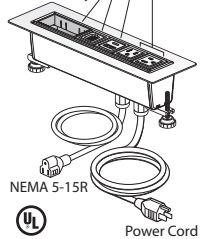

EUBI-SLOB-2112

4-Port:

- (4) Power

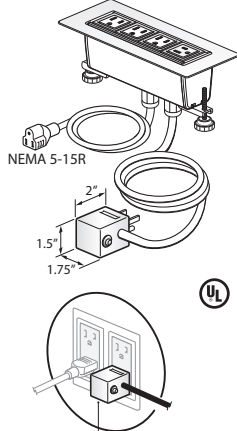

NOTE:
Always Circuit Breaker Plug
when more than 3
power outlets specified.

EUBI-SLOB-4000

Class YA – GSA: Open Market

Features

- Includes power module with 3, 4 or 6 ports that can be configured with simplex outlets (NEMA-5-15R), USB charging port (Smart USB-A+C), data ports or cable bay(s) that can accept up to two pull out data/AV cables and mounting hardware.
- Data port accommodate most varieties of field supplied data/ AV jacks.
- Corded power module with 15 amp - 12'(3658mm) long cord with plug (NEMA 5-15P).
- Auxiliary 24"(610mm) power cord with NEMA 5-15R used to provide power to table motor controller.
- The Smart USB-A+C allows for the 20W to be transferred between the 2 ports. If the USB-A is being used, the full wattage is sent to the USB-A, and the same for the USB-C. If both are being used, the wattage is distributed to each port and the port drawing the most power will receive more watts than the one that is not.
- Attaches to surface with use of included mounting brackets.
- Flush Mount has an overall housing depth of 4"(102mm) and will extend into mounting surface.
- Color option of black painted bezel with black receptacles or white painted bezel with white receptacles.

Specification Tips

- **Configuration and quantity of power and data ports cannot be modified in the field.**
- **For use with 120 volt 60 hertz power source only.**
- **For use with Height Adjustable Tables or Benching.**
- Designed to be used with cable chain.
- Requires field installation.
- Requires field cut access hole for power cord/conduit routing.
- Specify AV cables separately.
- Cable Bay requires cables less than 0.3"(8mm) diameter.
- Application may require approval of local authority having jurisdiction (AHJ); ensure compliance before placing orders and installation.

To Order, Specify:

- 1) Product number.
(No finish specification required.)

Worksurface Power Modules — Flush Mounted Power Cord for Height Adjustable

Top Depth	Top Width	Cord Length	Trim Color	Port Color	Port	Configuration	Number	Price
Corded								
3"(76mm)	6.75"(171mm)	12'(3658mm)	Black	Black	3	2 Power Receptacles, 1 Data Port	EUBI-SLOB-2010	\$1336.64
						2 Power Receptacles, 1 Smart USB-A+C Charging	EUBI-SLOB-2100	1440.46
						3 Power Receptacles	EUBI-SLOB-3000	1336.64
3"(76mm)	8.25"(210mm)				4	2 Power Receptacles, 1 Cable Bay	EUBI-SLOB-2002	\$1426.60
						2 Power Receptacles, 2 Data Ports	EUBI-SLOB-2020	1426.60
						2 Power Receptacles, 1 Smart USB-A+C Charging, 1 Data Port	EUBI-SLOB-2110	1530.42
						2 Power Receptacles, 2 Smart USB-A+C Charging	EUBI-SLOB-2200	1634.24
						3 Power Receptacles, 1 Data Port	EUBI-SLOB-3010	1426.60
						3 Power Receptacles, 1 Smart USB-A+C Charging	EUBI-SLOB-3100	1530.42
						4 Power Receptacles	EUBI-SLOB-4000	1426.60
3"(76mm)	9.75"(248mm)				6	2 Power Receptacles, 2 Cable Bays	EUBI-SLOB-2004	\$ 1516.62
						2 Power Receptacles, 2 Data Ports, 1 Cable Bay	EUBI-SLOB-2022	1516.62
						2 Power Receptacles, 4 Data Ports	EUBI-SLOB-2040	1516.62
						2 Power Receptacles, 1 Smart USB-A+C Charging, 1 Data Port, 1 Cable Bay	EUBI-SLOB-2112	1620.44
						2 Power Receptacles, 1 Smart USB-A+C Charging, 3 Data Ports	EUBI-SLOB-2130	1620.44
						2 Power Receptacles, 2 Smart USB-A+C Charging, 1 Cable Bay	EUBI-SLOB-2202	1724.26
						2 Power Receptacles, 2 Smart USB-A+C Charging, 2 Data Ports	EUBI-SLOB-2220	1724.26
						2 Power Receptacles, 3 Smart USB-A+C Charging, 1 Data Port	EUBI-SLOB-2310	1828.08
						2 Power Receptacles, 4 Smart USB-A+C Charging	EUBI-SLOB-2400	1931.90
						3 Power Receptacles, 1 Smart USB-A+C Charging, 1 Cable Bay	EUBI-SLOB-3012	1516.62
						3 Power Receptacles, 3 Data Ports	EUBI-SLOB-3030	1516.62
						3 Power Receptacles, 1 Smart USB-A+C Charging, 1 Cable Bay	EUBI-SLOB-3102	1620.44
						3 Power Receptacles, 1 Smart USB-A+C Charging, 2 Data Ports	EUBI-SLOB-3120	1620.44
						3 Power Receptacles, 2 Smart USB-A+C Charging, 1 Data Port	EUBI-SLOB-3210	1724.26
						3 Power Receptacles, 3 Smart USB-A+C Charging	EUBI-SLOB-3300	1828.08
						4 Power Receptacles, 1 Cable Bay	EUBI-SLOB-4002	1516.62
4 Power Receptacles, 2 Data Ports	EUBI-SLOB-4020	1516.62						
4 Power Receptacles, 1 Smart USB-A+C Charging, 1 Data Port	EUBI-SLOB-4110	1620.44						
4 Power Receptacles, 2 Smart USB-A+C Charging	EUBI-SLOB-4200	1724.26						
5 Power Receptacles, 1 Data Port	EUBI-SLOB-5010	1516.62						
5 Power Receptacles, 1 Smart USB-A+C Charging	EUBI-SLOB-5100	1620.44						
6 Power Receptacles	EUBI-SLOB-6000	1516.62						

Worksurface Power Modules — Flush Mounted Power Cord for Height Adjustable

Top Depth	Top Width	Cord Length	Trim Color	Port Color	Port	Configuration	Number	Price
3"(76mm)	6.75"(171mm)	12'(3658mm)	White	White	3	2 Power Receptacles, 1 Data Port	EUBI-SLOW-2010	\$1336.64
						2 Power Receptacles, 1 Smart USB-A+C Charging	EUBI-SLOW-2100	1440.46
						3 Power Receptacles	EUBI-SLOW-3000	1336.64
3"(76mm)	8.25"(210mm)				4	2 Power Receptacles, 1 Cable Bay	EUBI-SLOW-2002	\$1426.60
						2 Power Receptacles, 2 Data Ports	EUBI-SLOW-2020	1426.60
						2 Power Receptacles, 1 Smart USB-A+C Charging, 1 Data Port	EUBI-SLOW-2110	1530.42
						2 Power Receptacles, 2 Smart USB-A+C Charging	EUBI-SLOW-2200	1634.24
						3 Power Receptacles, 1 Data Port	EUBI-SLOW-3010	1426.60
						3 Power Receptacles, 1 Smart USB-A+C Charging	EUBI-SLOW-3100	1530.42
						4 Power Receptacles	EUBI-SLOW-4000	1426.60
3"(76mm)	9.75"(248mm)				6	2 Power Receptacles, 2 Cable Bays	EUBI-SLOW-2004	\$ 1516.62
						2 Power Receptacles, 2 Data Ports, 1 Cable Bay	EUBI-SLOW-2022	1516.62
						2 Power Receptacles, 4 Data Ports	EUBI-SLOW-2040	1516.62
						2 Power Receptacles, 1 Smart USB-A+C Charging, 1 Data Port, 1 Cable Bay	EUBI-SLOW-2112	1620.44
						2 Power Receptacles, 1 Smart USB-A+C Charging, 3 Data Ports	EUBI-SLOW-2130	1620.44
						2 Power Receptacles, 2 Smart USB-A+C Charging, 1 Cable Bay	EUBI-SLOW-2202	1724.26
						2 Power Receptacles, 2 Smart USB-A+C Charging, 2 Data Ports	EUBI-SLOW-2220	1724.26
						2 Power Receptacles, 3 Smart USB-A+C Charging, 1 Data Port	EUBI-SLOW-2310	1828.08
						2 Power Receptacles, 4 Smart USB-A+C Charging	EUBI-SLOW-2400	1931.90
						3 Power Receptacles, 1 Smart USB-A+C Charging, 1 Cable Bay	EUBI-SLOW-3012	1516.62
						3 Power Receptacles, 3 Data Ports	EUBI-SLOW-3030	1516.62
						3 Power Receptacles, 1 Smart USB-A+C Charging, 1 Cable Bay	EUBI-SLOW-3102	1620.44
						3 Power Receptacles, 1 Smart USB-A+C Charging, 2 Data Ports	EUBI-SLOW-3120	1620.44
						3 Power Receptacles, 2 Smart USB-A+C Charging, 1 Data Port	EUBI-SLOW-3210	1724.26
						3 Power Receptacles, 3 Smart USB-A+C Charging	EUBI-SLOW-3300	1828.08
						4 Power Receptacles, 1 Cable Bay	EUBI-SLOW-4002	1516.62
						4 Power Receptacles, 2 Data Ports	EUBI-SLOW-4020	1516.62
4 Power Receptacles, 1 Smart USB-A+C Charging, 1 Data Port	EUBI-SLOW-4110	1620.44						
4 Power Receptacles, 2 Smart USB-A+C Charging	EUBI-SLOW-4200	1724.26						
5 Power Receptacles, 1 Data Port	EUBI-SLOW-5010	1516.62						
5 Power Receptacles, 1 Smart USB-A+C Charging	EUBI-SLOW-5100	1620.44						
6 Power Receptacles	EUBI-SLOW-6000	1516.62						

Worksurface Power Modules — Flush Mounted Power Round

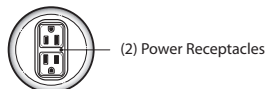
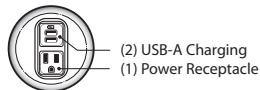
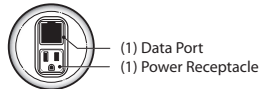
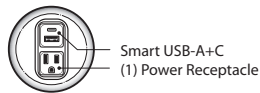
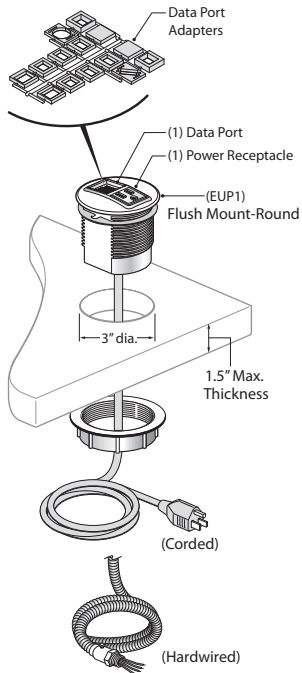

EUP1-PF
EUP1-HF



Class YA

Features

- Includes power module with 2 ports configured with simplex outlets (NEMA-5-15R), USB charging port or data ports and mounting hardware.
- Power Modules specified with a data port includes a variety of data port adapters and blank covers, which accommodate most varieties of field supplied data/AV jacks.
- The Smart USB-A+C allows for the 20W to be transferred between the 2 ports. If the USB-A is being used, the full wattage is sent to the USB-A, and the same for the USB-C. If both are being used, the wattage is distributed to each port and the port drawing the most power will receive more watts than the one that is not.
- Corded power module with 15 amp - 6'(1829mm) or 10'(3048mm) long cord with plug (NEMA 5-15P).
- Hardwire power module with 6'(1829mm) or 10'(3048mm) long flexible galvanized metal conduit.
- Smart USB-A+C can provide fast charge for a mobile phone and tablets. Occupies one charging port.

Specification Tips

- Installs into a 3" diameter hole into surfaces with a maximum thickness of 1.5".
- Configuration and quantity of power and data ports cannot be modified in the field.
- For use with 120 volt 60 hertz power source only.
- Requires field installation.
- Specify AV cables separately.
- Application may require approval of local authority having jurisdiction (AHJ); ensure compliance before placing orders and installation.

To Order, Specify:

- 1) Product number.
- 2) Trim color.
TR-PM1 Silver
TR-PM2 Midnight Black
TR-PM3 Parchment

Cord Length	Port	Configuration	Number	Price
Corded				
6'(1829mm)	2	1 Power Receptacle, 1 Data Port	EUP1-PFOP-100010	\$ 314.70
		1 Power Receptacle, 1 Smart USB-A+C Charging	EUP1-PFOP-101000	479.96
		2 Power Receptacles	EUP1-PFOP-200000	321.90
10'(3048mm)	2	1 Power Receptacle, 1 Data Port	EUP1-PJOP-100010	\$ 339.12
		1 Power Receptacle, 1 Smart USB-A+C Charging	EUP1-PJOP-101000	504.38
		2 Power Receptacles	EUP1-PJOP-200000	346.32
Hardwire				
6'(1829mm)	2	1 Power Receptacle, 1 Data Port	EUP1-HFOP-100010	\$ 415.70
		1 Power Receptacle, 1 Smart USB-A+C Charging	EUP1-HFOP-101000	580.96
		2 Power Receptacles	EUP1-HFOP-200000	422.90
10'(3048mm)	2	1 Power Receptacle, 1 Data Port	EUP1-HJOP-100010	\$440.12
		1 Power Receptacle, 1 Smart USB-A+C Charging	EUP1-HJOP-101000	605.38
		2 Power Receptacles	EUP1-HJOP-200000	447.32

Worksurface Power Modules — Power Tap

Horizontal

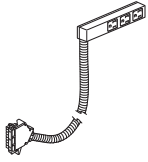

EUET-0030-3M3N
EUET-0030-2M3N
EUET-0030-4M3N



Class YA

Features

- Includes Power Tap housing with three 15A receptacle outlets (NEMA 5-15R) with 0.375"(10mm) conduit and Power Base connector.
- **Power Base connector is used to connect to PDA.**
- Power Tap housing with receptacles available in charcoal or graphite finish; conduit standard in black only.
- Field installed.

Specification Tips:

- Specify conduit length, circuit configuration and circuit access with Power Base connector.
- Specify mounting bracket separately.
 - Fixed Bracket with three patch cord holder mounts Power Tap to edge of worksurface with mounting screws. **Horizontal Power Tap required.**
 - Adjustable bracket mounts Power Tap to edge of worksurface with thumb screws for ease of relocation. **Horizontal Power Tap required.**
- Application may require approval of local authority having jurisdiction (AHJ); ensure compliance before placing orders and installation.
- Do not mix 3-circuit and 6-circuit with 4-circuit components. Do not mix 2+2 and 3+1 components. Components have unique polarity key and color coding (3-circuit=black, 6-circuit=ivory, 2+2=blue and 3+1=green).

To Order, Specify:

- 1) Product number.
- 2) Trim color.
 - TR-K Charcoal
 - TR-J Graphite

Description	Circuit Access	Number	Price
3-Circuit Conduit Length			
30"(762mm)	1	EUET-0030-3M3N1NL	\$224.65
	2	EUET-0030-3M3N2NL	224.65
	3	EUET-0030-3M3N3NL	224.65
6'(1829mm)	1	EUET-0072-3M3N1NL	\$ 261.33
	2	EUET-0072-3M3N2NL	261.33
	3	EUET-0072-3M3N3NL	261.33
9'(2743mm)	1	EUET-00A8-3M3N1NL	\$292.77
	2	EUET-00A8-3M3N2NL	292.77
	3	EUET-00A8-3M3N3NL	292.77
4-Circuit, (2+2) Conduit Length			
30"(762mm)	1	EUET-0030-2M3N1NL	\$224.65
	2	EUET-0030-2M3N2NL	224.65
	3	EUET-0030-2M3N3NL	224.65
	4	EUET-0030-2M3N4NL	224.65
6'(1829mm)	1	EUET-0072-2M3N1NL	\$ 261.33
	2	EUET-0072-2M3N2NL	261.33
	3	EUET-0072-2M3N3NL	261.33
	4	EUET-0072-2M3N4NL	261.33
9'(2743mm)	1	EUET-00A8-2M3N1NL	\$292.77
	2	EUET-00A8-2M3N2NL	292.77
	3	EUET-00A8-2M3N3NL	292.77
	4	EUET-00A8-2M3N4NL	292.77
4-Circuit, (3+1) Conduit Length			
30"(762mm)	1	EUET-0030-4M3N1NL	\$224.65
	2	EUET-0030-4M3N2NL	224.65
	3	EUET-0030-4M3N3NL	224.65
	4	EUET-0030-4M3N4NL	224.65
6'(1829mm)	1	EUET-0072-4M3N1NL	\$ 261.33
	2	EUET-0072-4M3N2NL	261.33
	3	EUET-0072-4M3N3NL	261.33
	4	EUET-0072-4M3N4NL	261.33
9'(2743mm)	1	EUET-00A8-4M3N1NL	\$292.77
	2	EUET-00A8-4M3N2NL	292.77
	3	EUET-00A8-4M3N3NL	292.77
	4	EUET-00A8-4M3N4NL	292.77

Worksurface Power Modules — Power Tap

Vertical

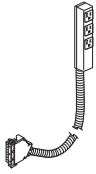

EUET-0030-3M3N
EUET-0030-2M3N
EUET-0030-4M3N



Class YA

Features

- Includes Power Tap housing with three 15A receptacle outlets (NEMA 5-15R) with 0.375"(10mm) conduit and Power Base connector.
- **Power Base connector is used to connect to PDA.**
- Power Tap housing with receptacles available in charcoal or graphite finish; conduit standard in black only.
- Field installed.

Specification Tips:

- Specify conduit length, circuit configuration and circuit access with Power Base connector.
- Specify mounting bracket separately.
 - Fixed Bracket with three patch cord holder mounts Power Tap to edge of worksurface with mounting screws. **Horizontal Power Tap required.**
 - Adjustable bracket mounts Power Tap to edge of worksurface with thumb screws for ease of relocation. **Horizontal Power Tap required.**
- Application may require approval of local authority having jurisdiction (AHJ); ensure compliance before placing orders and installation.
- Do not mix 3-circuit and 6-circuit with 4-circuit components. Do not mix 2+2 and 3+1 components. Components have unique polarity key and color coding (3-circuit=black, 6-circuit=ivory, 2+2=blue and 3+1=green).

To Order, Specify:

- 1) Product number.
- 2) Trim color.
 - TR-K Charcoal
 - TR-J Graphite

Description	Circuit Access	Number	Price
3-Circuit Conduit Length			
30"(762mm)	1	EUET-0030-3M3N1NS	\$224.65
	2	EUET-0030-3M3N2NS	224.65
	3	EUET-0030-3M3N3NS	224.65
6'(1829mm)	1	EUET-0072-3M3N1NS	\$ 261.33
	2	EUET-0072-3M3N2NS	261.33
	3	EUET-0072-3M3N3NS	261.33
9'(2743mm)	1	EUET-00A8-3M3N1NS	\$292.77
	2	EUET-00A8-3M3N2NS	292.77
	3	EUET-00A8-3M3N3NS	292.77
4-Circuit (2+2) Conduit Length			
30"(762mm)	1	EUET-0030-2M3N1NS	\$224.65
	2	EUET-0030-2M3N2NS	224.65
	3	EUET-0030-2M3N3NS	224.65
	4	EUET-0030-2M3N4NS	224.65
6'(1829mm)	1	EUET-0072-2M3N1NS	\$ 261.33
	2	EUET-0072-2M3N2NS	261.33
	3	EUET-0072-2M3N3NS	261.33
	4	EUET-0072-2M3N4NS	261.33
9'(2743mm)	1	EUET-00A8-2M3N1NS	\$292.77
	2	EUET-00A8-2M3N2NS	292.77
	3	EUET-00A8-2M3N3NS	292.77
	4	EUET-00A8-2M3N4NS	292.77
4-Circuit (3+1) Conduit Length			
30"(762mm)	1	EUET-0030-4M3N1NS	\$224.65
	2	EUET-0030-4M3N2NS	224.65
	3	EUET-0030-4M3N3NS	224.65
	4	EUET-0030-4M3N4NS	224.65
6'(1829mm)	1	EUET-0072-4M3N1NS	\$ 261.33
	2	EUET-0072-4M3N2NS	261.33
	3	EUET-0072-4M3N3NS	261.33
	4	EUET-0072-4M3N4NS	261.33
9'(2743mm)	1	EUET-00A8-4M3N1NS	\$292.77
	2	EUET-00A8-4M3N2NS	292.77
	3	EUET-00A8-4M3N3NS	292.77
	4	EUET-00A8-4M3N4NS	292.77

Worksurface Power Modules — Power Tap

Hardwire and Corded

Hardwire

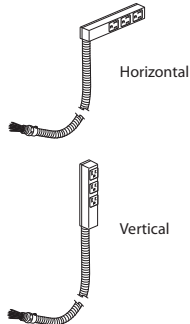

EUET-0030-CM3N



Class YA

Features

- Includes Power Tap with three 15A receptacle outlets (MEMA 5-15) with conduit and conduit fitting.
- Hardwire option for connection to field wired junction box with 0.5”(13mm) knockout.
- Power Tap housing with receptacles available in charcoal or graphite finish; conduit standard in black only.
- Field installed.

Specification Tips

- **For use with 120 volt 60 hertz power source only.**
- **Specify mounting bracket separately.**
 - Fixed Bracket with three patch cord holder mounts Power Tap to edge of worksurface with mounting screws. **Horizontal Power Tap required.**
 - Adjustable bracket mounts Power Tap to edge of worksurface with thumb screws for ease of relocation. **Horizontal Power Tap required.**
 - Under Surface bracket mounts Power Tap under worksurface. **Vertical Power Tap required.**
- Application may require approval of local authority having jurisdiction (AHJ); ensure compliance before placing orders and installation.

To Order, Specify:

- 1) Product number.
- 2) Trim color.
 - TR-K Charcoal
 - TR-J Graphite

Description	Circuit	Number	Price
Hardwire Length — Horizontal			
30”(762mm)	1	EUET-0030-CM3N1NL	\$224.65
6”(1829mm)	1	EUET-0072-CM3N1NL	261.33
9”(2743mm)	1	EUET-00A8-CM3N1NL	292.77
15”(4572mm)	1	EUET-00J0-CM3N1NL	355.65
Hardwire Length — Vertical			
30”(762mm)	1	EUET-0030-CM3N1NS	\$224.65
6”(1829mm)	1	EUET-0072-CM3N1NS	261.33
9”(2743mm)	1	EUET-00A8-CM3N1NS	292.77
15”(4572mm)	1	EUET-00J0-CM3N1NS	355.65

Corded

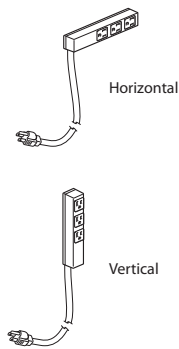

EUET-0000-1M3N



Class YA

Features

- Includes Power Tap with three 15A receptacle outlets (MEMA 5-15R) with cord and plug (15A NEMA 5-15-P).
- Power Tap housing with receptacles available in charcoal or graphite finish; cord standard in black only.
- Field installed.

Specification Tips

- **For use with 120 volt 60 hertz power source only.**
- **Specify mounting bracket separately.**
 - Fixed Bracket with three patch cord holder mounts Power Tap to edge of worksurface with mounting screws. **Horizontal Power Tap required.**
 - Adjustable bracket mounts Power Tap to edge of worksurface with thumb screws for ease of relocation. **Horizontal Power Tap required.**
 - Under Surface bracket mounts Power Tap under worksurface. **Vertical Power Tap required.**
- Application may require approval of local authority having jurisdiction (AHJ); ensure compliance before placing orders and installation.

To Order, Specify:

- 1) Product number.
- 2) Trim color.
 - TR-K Charcoal
 - TR-J Graphite

Description	Circuit	Number	Price
Corded Length — Horizontal			
6”(1829mm)	1	EUET-0000-1M3N16L	\$ 159.12
9”(2743mm)	1	EUET-0000-1M3N19L	170.34
15”(4572mm)	1	EUET-0000-1M3N1EL	192.78
25”(7620mm)	1	EUET-0000-1M3N1YL	230.18
Corded Length — Vertical			
6”(1829mm)	1	EUET-0000-1M3N16S	\$ 159.12
9”(2743mm)	1	EUET-0000-1M3N19S	170.34
15”(4572mm)	1	EUET-0000-1M3N1ES	192.78
25”(7620mm)	1	EUET-0000-1M3N1YS	230.18

Worksurface Power Modules — Power Tap Brackets

Fixed

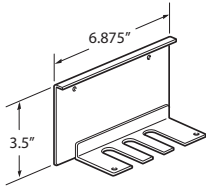

ZUAP-0000-PFD
Class YA

Features

- Includes one Power Tap mounting bracket and mounting hardware.
- Fixed Bracket mounts Power Tap to edge of worksurface with mounting screws.
- Fixed bracket accommodates three patch cords.
- **Horizontal Power Tap required.**

Specification Tips

- **Accommodates 1.18" (30mm) thick tops with clear space below.**
- Power Tap applications should be reviewed by local authorities (electrical inspector) prior to ordering due to varying local codes.
- **Not compatible with the Power Tap-Corded shipped prior to July 2013.**

To Order, Specify:

- 1) Product number.
- 2) Trim color.

Description	Number	Trim	
		A	B
	ZUAP-0000-PFD	\$65.52	\$74.91

Adjustable

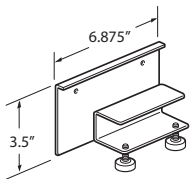

ZUAP-0000-PAN
Class YA

Features

- Includes one Power Tap mounting bracket and mounting hardware.
- Adjustable bracket mounts Power Tap to back edge of worksurface with thumb screws for ease of relocation.
- **Horizontal Power Tap required.**

Specification Tips

- **Accommodates 1.18" (30mm) thick tops with clear space below.**
- Adjustable Power Tap Bracket may interfere with Screen application.
- Power Tap applications should be reviewed by local authorities (electrical inspector) prior to ordering due to varying local codes.
- **Not compatible with the Power Tap-Corded shipped prior to July 2013.**

To Order, Specify:

- 1) Product number.
- 2) Trim color.

Description	Number	Trim	
		A	B
	ZUAP-0000-PAN	\$82.36	\$91.75

Under Surface

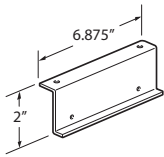

ZUAP-000-PUR
Class YA

Features

- Includes one Power Tap mounting bracket and mounting hardware.
- Under Surface bracket mounts Power Tap under worksurface.
- **Vertical Power Tap required.**

Specification Tips

- **Accommodates 1.18" (30mm) thick tops with clear space below.**
- Under surface bracket may be used on top of worksurface in restricted reach (ADA) applications. Mounting screws will deface top of worksurface.
- Power Tap applications should be reviewed by local authorities (electrical inspector) prior to ordering due to varying local codes.
- **Not compatible with the Power Tap-Corded shipped prior to July 2013.**

To Order, Specify:

- 1) Product number.
- 2) Trim color.

Description	Number	Trim	
		A	B
Under Surface — Right-hand	ZUAP-0000-PUR	\$65.52	\$74.91
Under Surface — Left-hand	ZUAP-0000-PUL	65.52	74.91

Bracket with Grommet

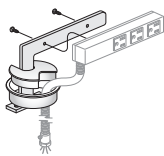

ZUAP-0000-PGH
Class YA

Features

- Includes one Power Tap bracket, grommet with cover and mounting hardware.
- Horizontal bracket mounts to top through field installed grommet. Horizontal Power Tap required.
- Vertical bracket mounts to top through field installed grommet. Vertical Power Tap required.

Specification Tips

- **Accommodates 1.18" (30mm) thick tops with clear space below.**
- Application may require approval of local authority having jurisdiction (AHJ); ensure compliance before placing orders and installation.
- Power Tap Bracket with grommet can only be used with 3-Circuit, 4-Circuit and Hardwired power taps.

To Order, Specify:

- 1) Product number.
- 2) Trim color.

Description	Number	Trim	
		A	B
Fixed Grommet — Horizontal	ZUAP-0000-PGH	\$147.88	\$157.27
Fixed Grommet — Vertical	ZUAP-0000-PGV	147.88	157.27

Worksurface Power Modules — Other Power and Data

Data Bezel

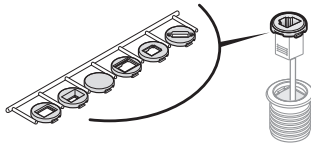

EURT-0000-N001CB
EURT-0000-N001CW

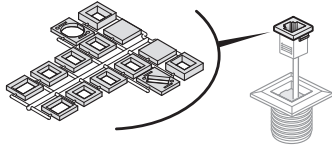

EURT-0000-N001SB
EURT-0000-N001SW
Class QA

Features

- Includes one round or square bezel for the Bezel Utility Module.
- Available in black or supplier white only.

To Order, Specify:

- 1) Product number.
(No finish specification required.)

Description	Number	Price
Round		
Black	EURT-0000-N001CB	\$124.16
White	EURT-0000-N001CW	124.16
Square		
Black	EURT-0000-N001SB	\$124.16
White	EURT-0000-N001SW	124.16

Bezel Utility Module

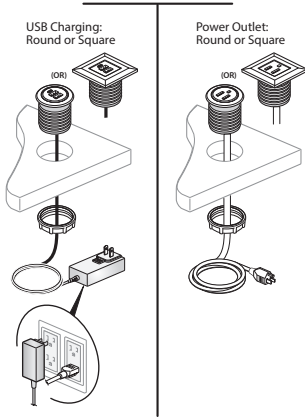

EURT-0072-1100
EURT-0072-1010



Class QA

Features

- Includes: Either a round or square faced Power Module and mounting hardware.
- For use on surfaces 0.75"(19mm) - 1.44"(37mm) thick.
- Available with either:
 - One power outlet (NEMA 5-15R)
 - One two port USB charger. Consists of two USB outlets with 1000mA of charging power (5 volts) per USB outlet.
 - One data/video jack
- Available in black or supplier white only.

Specification Tips

- For use with 120 volt 60 hertz power source only.
- Power configuration has one cord with plug (NEMA 5-15P).
- USB configuration has one cord with 2"(51mm) x 1"(25mm) x 3"(76mm) voltage transformer plug. Transformer may block adjacent outlets (see illustration).
- Data jacks and AV cables field supplied.
- Data jack adapters accommodate most varieties of field supplied data jacks or separately specified AV cables.
- Requires field cut 1.75"(44mm) hole and field installation.
- Application may require approval of local authority having jurisdiction (AHJ); ensure compliance before placing orders and installing.

To Order, Specify:

- 1) Product number, including:

1 Shape:

- S** Square
- C** Round

2 Color Options:

- B** Black
- W** White

Description	Depth	Number	12	Price
6'(1829mm) Cord				
Power	1.75"(44mm)	EURT-0072-1100	■ ■	\$ 124.16
USB		EURT-0072-1010	■ ■	372.51
12'(3658mm) Cord				
Power	1.75"(44mm)	EURT-00E4-1100	■ ■	\$ 212.85
USB		EURT-00E4-1010	■ ■	461.20

Worksurface Power Modules — Other Power and Data

Collaborative Power Station

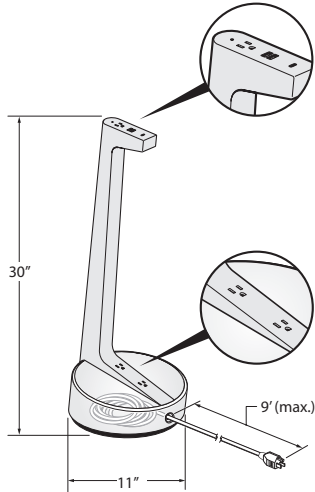

EUCN-PJ



Class YA

Features

- Includes power module with 5 ports (3 on the top and 2 on the bottom) configured with simplex outlets (NEMA-5-15R) and USB charging port.
- Corded power module with 15 amp - 9'(2743mm) long cord with plug (NEMA 5-15P). Ensure power is within 9'(2743mm) of desired location.
- USB-A provides two 10W charging ports.
- USB-C 18W provides a single 18w USB-C port that can provide a fast charge for mobile phones and tablets.
- Color options:
 - Fog/Matte Fog
 - Storm/Matte Storm
 - Black/Matte Black
 - Fog/Weathered Aspen Veneer

Specification Tips

- Configuration and quantity of power and data ports cannot be modified in the field.
- For use with 120 volt 60 hertz power source only.
- Requires field installation.
- Application may require approval of local authority having jurisdiction (AHJ); ensure compliance before placing orders and installation.

To Order, Specify:

- 1) Product number.
(No finish specification required.)

Color	Number	Price
Fog/Matte Fog	EUCN-PJOF-311	\$1386.65
Storm/Matte Storm	EUCN-PJOS-311	1386.65
Black/Matte Black	EUCN-PJOB-311	1386.65
Fog/Weathered Aspen Veneer	EUCN-PJOV-311	1914.00

Worksurface Power Modules — Other Power and Data

Retrofit USB Charging Cable

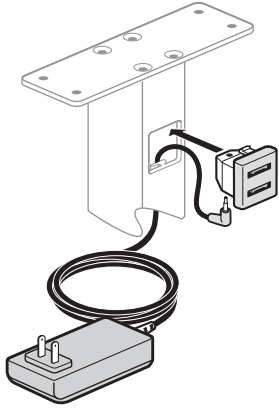

EUDX-3000-B



Class TK

Features

- Includes one USB charging simplex (with two USB outlets) with 72”(1829mm) cord and power supply.
- Installs in an open data port in one of the following products:
 - Flip Top Unit
 - Double Sided Flip Top Unit
 - Quick Connect Power
 - Flush Mount Module
 - Enhanced Power Module
- USB Charging Port consists of 2 USB outlets. 1,000mA of charging power per USB outlet.

To Order, Specify:

- 1) Product number.
(No finish specification required.)

Length	Description	Color	Number	Price
72”(1829mm)		Black	EUDX-U000-B	\$197.38
		White	EUDX-U000-W	197.38

Cables

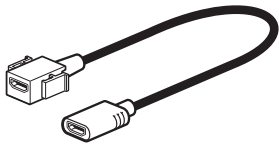

EUDX-H000-B

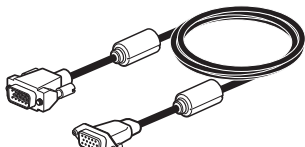

EUDX-V000-B



EUDX-3000-B
Class TK

Features

- Includes one black HDMI Coupler, one VGA cable or one 3.5mm mini audio cable.
- Installs in an open data port in one of the following products:
 - Flip Top Unit
 - Double Sided Flip Top Unit
 - Quick Connect Power
 - Flush Mount Module
 - Enhanced Power Module
 - Data Bezel

To Order, Specify:

- 1) Product number.
(No finish specification required.)

Specification Tips

- Provides communication between components: i.e. laptop, processor, monitor, etc.
- HDMI transmits digital video signals.
- VGA transmits analog video signals without audio.

Length	Description	Color	Number	Price
HDMI Coupler				
N/A	HDMI	Black	EUDX-H000-B	\$214.26
N/A	HDMI	White	EUDX-H000-W	214.26
VGA Cable				
120”(3048mm)	VGA	Black	EUDX-V000-B	\$257.12
	VGA	White	EUDX-V000-W	257.12
Audio Cable — 3.5mm				
120”(3048mm)	VGA	Black	EUDX-3000-B	\$ 60.01
	VGA	White	EUDX-3000-W	60.01

Wire/Cable Management — Horizontal

Wire Management Tray

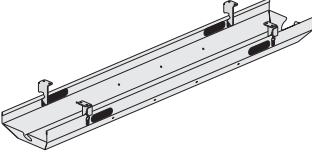
General Specifications	Product Name	Approved Table Depths	Approved Table Widths	Reduce Tray Width Leg Clearance	Example Calculation To Determine Tray Width
	Upside - Height Adjustable Table C-Leg and T-Leg/Rectangle Top	29"(737mm)	46"(1168mm), 52"(1321mm), 58"(1473mm), 64"(1626mm), 70"(1778mm), 76"(1930mm), 82"(2083mm)	22"(559mm)	64"(1626mm) Table Width - 22"(559mm) Reduce Tray Width 42"(1067mm) Tray Width
	Planes - Height Adjustable Table C-Leg/Rectangle Top	29"(737mm)	58"(1473mm), 64"(1626mm), 70"(1778mm)	22"(559mm)	64"(1626mm) Table Width - 22"(559mm) Reduce Tray Width 42"(1067mm) Tray Width
	Planes LT Model Height Adjustable Table C-Leg and T-Leg/Rectangle Top	29"(737mm)	58"(1473mm), 64"(1626mm), 70"(1778mm)	22"(559mm)	64"(1626mm) Table Width - 22"(559mm) Reduce Tray Width 42"(1067mm) Tray Width
	Masters Series Height Adjustable Table Rectangle Top	30"(762mm), 36"(914mm), 42"(1067mm)	60"(1524mm), 66"(1676mm), 72"(1829mm)	22"(559mm)	64"(1626mm) Table Width - 22"(559mm) Reduce Tray Width 42"(1067mm) Tray Width
	Masters Series Height Adjustable Table with Storage Integration Rectangle Top	30"(762mm), 36"(914mm), 42"(1067mm)	66"(1676mm), 72"(1829mm), 78"(1981mm), 84"(2134mm)	30"(762mm)	66"(1676mm) Table Width - 30"(762mm) Reduce Tray Width 36"(914mm) Tray Width
	Jive Table - Dual Disc Base Rectangle Top	30"(762mm), 36"(914mm), 42"(1067mm)	72"(1829mm), 84"(2134mm), 96"(2438mm)	36"(914mm)	72"(1829mm) Table Width - 36"(914mm) Reduce Tray Width 36"(914mm) Tray Width
	Jive Table - T-Leg - Round Column Rectangle Top	36"(914mm)	66"(1676mm), 72"(1829mm), 84"(2134mm)	12"(305mm)	66"(1676mm) Table Width - 12"(305mm) Reduce Tray Width 54"(1372mm) Tray Width
	Jive Table - T-Leg - Extruded Column Rectangle Top	30"(762mm), 36"(914mm)	54"(1372mm), 60"(1524mm), 66"(1676mm), 72"(1829mm)	18"(457mm)	60"(1524mm) Table Width - 18"(457mm) Reduce Tray Width 42"(1067mm) Tray Width
	Jive Table - C-Leg Extruded and Round Column Rectangle Top	30"(762mm)	54"(1372mm), 60"(1524mm), 66"(1676mm), 72"(1829mm)	18"(457mm)	72"(1829mm) Table Width - 18"(457mm) Reduce Tray Width 54"(1372mm) Tray Width
	Jive Table Post Round Base and Post Extruded Base Rectangle Top	30"(762mm), 36"(914mm)	42"(1067mm), 48"(1219mm), 54"(1372mm), 60"(1524mm), 66"(1676mm), 72"(1829mm), 84"(2134mm)	6"(152mm)	42"(1067mm) Table Width - 6"(152mm) Reduce Tray Width 36"(914mm) Tray Width
	Adaptable Worksurface Rectangle Worksurface	30"(762mm)	42"(1067mm), 48"(1219mm), 54"(1372mm), 60"(1524mm), 72"(1829mm)	6"(152mm)	48"(1219mm) Table Width - 6"(152mm) Reduce Tray Width 42"(1067mm) Tray Width
	Cultivate Table Frames	36"(914mm), 42"(1067mm)	60"(1524mm), 72"(1829mm) Wide Frames	12"(305mm)	60"(1524mm) Table Width - 12"(305mm) Reduce Tray Width 48"(1219mm) Tray Width
			84"(2134mm), 96"(2438mm) Wide Frames	12"(305mm)	84"(2134mm) Table Width - 12"(305mm) Reduce Tray Width 72"(1829mm) Tray Width (use two 36"(914mm) wide trays)

Wire/Cable Management — Horizontal

Wire Management Tray

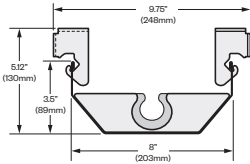
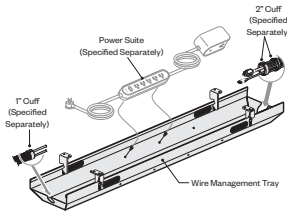

EUWT
Class YA - GSA: Open Market

Features

- Includes one metal tray and four attachment brackets with thumb tabs to assist with opening tray.
- Tray flips down to provide access to power and data cords. It can be accessed by the back or the user side.
- Belong Plug Strip can be mounted into the tray.
- Tray can accept both the 1" (25mm) and 2" (51mm) Cuffs. Reverse tray for correct opening.

Specification Tips

- Tray width must be undersized due to the understructure of the table. See Wire Management Tray General Specifications application details.
- Not designed to be used on 23" (584mm) D tables or worksurfaces due to knee clearance.
- 1.5H storage placed under a fixed worksurface will not have enough clearance for a Wire Management Tray.
- Not designed for use on Flip Top Tables (Planes or Jive).
- Product is available in all standard trim colors.

To Order, Specify:

- 1) Product number.
- 2) Trim color.

Description	Number	Trim	
		A	B
22"(559mm)	EUWT-0822-P	\$222.98	\$238.98
30"(762mm)	EUWT-0830-P	234.02	250.02
36"(914mm)	EUWT-0836-P	242.30	258.30
42"(1067mm)	EUWT-0842-P	250.58	266.58
48"(1219mm)	EUWT-0848-P	258.86	274.86
54"(1372mm)	EUWT-0854-P	267.14	283.14
60"(1524mm)	EUWT-0860-P	275.42	291.42

Wire/Cable Management — Horizontal

Wire Management Basket

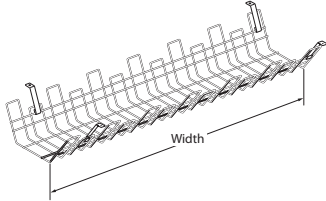

TAWB
Class YA – GSA: Open Market

Features

- Includes one basket, four brackets and attachment hardware.
- Standard in black.
- Basket is 8.5”(203mm) deep x 3.5”(76mm) high. With mounting hardware overall height is 4.94”(102mm) and depth is 10.82”(254mm).
- Accessible from both sides.
- Basket detaches without tools.

Specification Tips

- Verify mounting clearance with table understructure.
- Separately specify covers.

To Order, Specify:

- 1) Product number.
(No finish specification required.)

Width	Number	Price
18”(457mm)	TAWB-0918	\$180.24
24”(610mm)	TAWB-0924	189.28
36”(914mm)	TAWB-0936	207.29

Basket Cover

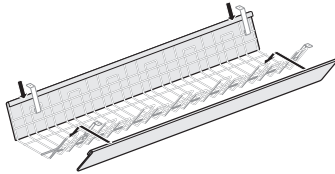

TABC (Two covers shown)
Class TA – GSA: Open Market

Features

- Includes one painted cover.

Specification Tips

- Designed to be used with wire management basket. Up to two can be installed.
- Order to match wire management basket width.

To Order, Specify:

- 1) Product number.
 - 2) Trim color.
- Note:** \$15.63 upcharge list for Metallic and Accent trim colors.

Width	Number	Price
18”(457mm)	TABC-0918	\$ 49.78
24”(610mm)	TABC-0924	66.83
36”(914mm)	TABC-0936	100.81

Height Adjustable Table

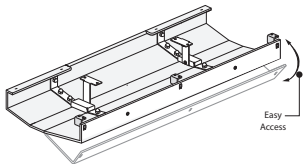

AKWN
Class TR01 – Open Market

Features

- Includes one PET (Polyethylene Terephthalate) cable manager, tray and attachment hardware.
- Available in three colors: Dusk, Flint, and Mink.
- Ships unassembled.

Specification Tips

- Not for use with Compose Echo table.
- Not designed for use on Flip Top Tables (Planes or Jive).
- Use a low profile monitor arm bracket with the tray.
- Refer to Electrical Components Belong Wire Management Tray General Specifications
- Application may require approval of local authority having jurisdiction (AHJ); ensure compliance before placing orders and installation.

To Order, Specify:

- 1) Product number.
- 2) PET color.
PET-C1 Dusk
PET-C2 Flint
PET-C4 Mink

Depth	Width	Number	Price
12”(305mm)	30”(762mm)	AKWN-1230-EUN	\$377.69

Wire Manager — Horizontal

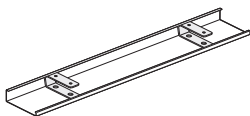

EUAW-NH
Class YA

Features

- Includes one wire manager and attachment clips.
- Standard in light platinum.
- Field installed.
- Manages and stores wire and cables under horizontal surfaces.

To Order, Specify:

- 1) Product number.
(No finish specification required.)

Length	Clips	Number	Price
48”(1219mm)	2	EUAW-0048-NH	\$ 215.77
72”(1829mm)	3	EUAW-0072-NH	323.64
96”(2438mm)	3	EUAW-0096-NH	431.51
120”(3048mm)	4	EUAW-00C0-NH	539.21

Wire/Cable Management — Horizontal

J-Channel

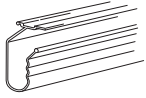

4TJC-72
Class TA

Features

- Includes J-Channel and mounting hardware.
- Field-installed.
- Provides wire management below table tops.
- Attaches to the underside of the table top with screws.
- J-channel to be field cut to length.
- Available in black finish color only.

To Order, Specify:

- 1) Product number.
(No finish specification required.)

Length	Height	Width	Description	Number	Price
72"(1829mm)	4.25"(108mm)	2.75"(70mm)	Straight table	4TJC-72	\$288.20

Horizontal Wire Management

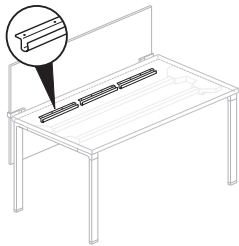

WUAW-PNH
Class CA

Features

- Includes ten plastic wire managers and attachment hardware.
- Manages and stores wires or cables under horizontal surface.
- Standard in charcoal trim color only.

To Order, Specify:

- 1) Product number.
(No finish specification required.)

Length	Depth	Number	Price
15"(381mm)	2"(51mm)	WUAW-1500-PNH	\$294.80

Wire/Cable Management — Vertical

Cord Management Cuff

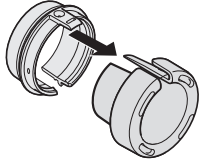

EUAC
Class YA – GSA: Open Market

Features

- Includes one bag of 26 - 2"(51mm) Cuffs or one bag of 50 - 1"(25mm) Cuffs.
- Product is applied to both ends of the separately specified Mesh Cord Manager and one end snaps into the Belong Wire Management Tray.

Specification Tips

- The size of the cuff aligns with the size of the Mesh Cord Wire Manager used.
- The Wire Management Tray can accept both the 1"(25mm) and 2"(51mm) cuff.
- Split cuff allows side insertion of cord or cable less than .5"(13mm) diameter. The shape or size of plug does not impede installation of cuff over cord cables.
- Available in charcoal TR-K only.
- Loom Insertion Tool Epart 2442-4401 is recommended for easier installation.

To Order, Specify:

- 1) Product number.
(No finish specification required.)

Description	Number	Price
1"(25mm) Bag of 50	EUAC-0001-C	\$200.29
2"(51mm) Bag of 26	EUAC-0002-C	160.23

Mesh Cord Manager with Cuffs

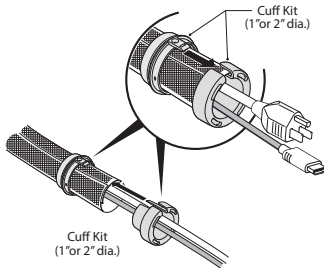

EUAW
Class YA – GSA: Open Market

Features

- Includes one bag of 26 - 2"(51mm) Cuffs or one bag of 50 - 1"(25mm) Cuffs and Cord Manager.
- Product is applied to both ends of the Mesh Cord Manager and one end snaps into the Belong Wire Management Tray.

Specification Tips

- The size of the Cuff aligns with the size of the Mesh Cord Wire Manager used.
- The Wire Management Tray can accept both the 1"(25mm) and 2"(51mm) Cuff.
- Available in grey, white or black.
- Loom Insertion Tool Epart 24424401 is recommended for easier installation.

To Order, Specify:

- 1) Product number.
(No finish specification required.)

Description	Number	Price
100'(30480mm) 1"(25mm) with 50 Cuffs	Grey	EUAW-A001-CG \$1058.96
	White	EUAW-A001-CW 1058.96
	Black	EUAW-A001-CB 1058.96
1"(25mm) with No Cuffs	Grey	EUAW-A001-NG 887.28
	White	EUAW-A001-NW 887.28
	Black	EUAW-A001-NB 887.28
50'(15240mm) 2"(51mm) with 26 Cuffs	Grey	EUAW-5002-CG \$ 1018.90
	White	EUAW-5002-CW 1018.90
	Black	EUAW-5002-CB 1018.90
2"(51mm) with No Cuffs	Grey	EUAW-5002-NG 887.28
	White	EUAW-5002-NW 887.28
	Black	EUAW-5002-NB 887.28

Mesh Cord Manager Bracket

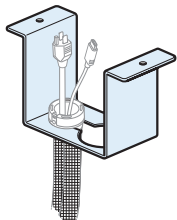

EUEA-CABR
Class YA – GSA: Open Market

Features

- Includes bracket and attachment hardware.
- Standard in black.

Specification Tips

- Designed to attach to the underside of a worksurface.
- For use with both 1"(25mm) and 2"(51mm) mesh cord manager with cuff.

To Order, Specify:

- 1) Product number.
(No finish specification required.)

Number	Price
EUEA-CABR	\$46.00

Wire/Cable Management — Vertical

Vertical Wire Channel – Leg Attached

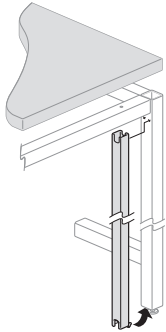

TYVW
Class CL – GSA: Open Market

Features

- Includes wire manager and attachment screws.

Specification Tips

- Order correct model for table height.
- Add additional Vertical Wire Channels if cord number exceeds three cords.
- Accommodates 2-3 cords/cables (depending on cable diameter) or one 0.5”(13mm) Flexible Conduit.

To Order, Specify:

- 1) Product number.
- 2) Trim color.

For Use With	Height	Width	Number	Trim	
				A	B
28”(711mm) Frame	25.7”(653mm)	1.17”(30mm)	TYVW-2601-P	\$ 114.85	\$ 121.62
40”(1016mm) Frame	37.7”(958mm)	1.17”(30mm)	TYVW-3801-P	120.80	130.67

Vertical Cable Guide

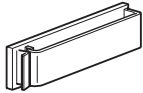

NECG-V
Class BC

Features

- Includes package of twelve cable guides.
- Manages communication cables.
- Self-adhesive back attaches to the top or bottom of horizontal surface.
- Standard in gray trim color only.

To Order, Specify:

- 1) Product number.
(No finish specification required.)

Height	Depth	Width	Number	Price
0.75”(19mm)	0.5”(13mm)	3”(76mm)	NECG-V	\$170.38

Wire Manager — Vertical

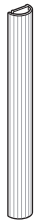

CPVC-1
Class RA

Features

- For channeling cords neatly on outside of any table base.
- Standard in black finish only.

To Order, Specify:

- 1) Product number.
(No finish specification required.)

Height	Depth	Width	Number	Price
26”(660mm)	0.5”(13mm)	1.18”(30mm)	CPVC-1	\$51.44

Wire/Cable Management Accessories

Clips

Conduit Clamp

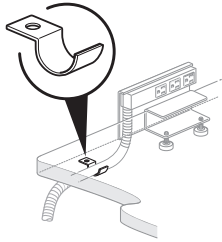

EUAM-0000
Class YA

Features

- Includes 25 clamps and 25 screws.
- For managing Power Tap cord or conduit under horizontal surfaces.

To Order, Specify:

- 1) Product number.
(No finish specification required.)

Number	Price
EUAM-0000	\$93.59

Wire Management Loop

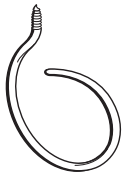

NEH-8
Class YA

Features

- Includes box of eight wire management loops.
- Manages and stores wires or cables through loops attached to horizontal surface.
- Threaded top allows installation anywhere under horizontal surfaces in recommended 18"(457mm) intervals.
- Wire management loop is 2"(51mm) in diameter with 3.1 sq. in.(2000mm²) of cross section area.
- Standard in charcoal trim color only.

To Order, Specify:

- 1) Product number.
(No finish specification required.)

Width	Installed Height	Number	Price
2.75"(70mm)	3.25"(83mm)	NEH-8	\$64.61

Wire Manager Clips

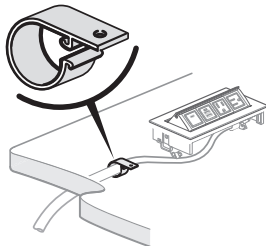

TA01-0225
Class TA

Features

- Includes ten wire manager clips and screws.
- Standard in black plastic.
- Field installed.

Specification Tips

- Specify for cord management as needed.

To Order, Specify:

- 1) Product number.
(No finish specification required.)

Number	Price
TA01-0225	\$32.87

Wire/Cable Management Accessories

Belong Hatch

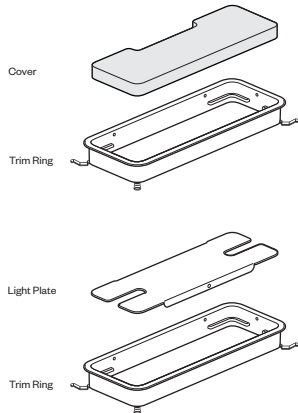

EUAH-0512
Class YA

Features

- Includes trim ring with tabs, cover or light plate.
- Available in two configurations: cover with trim ring or light plate with trim ring.
- Light plate configuration to be used with the separately specified Talia light located in the Ancillary Price List.
- Belong Hatch will sit flush with the worksurface and will always be centered on the worksurface with the exception of Upside Worksurface 90° Equal Corner - Wrap-Around or 90° Extended Corner-Wrap-Around which will be placed on the worksurface side with a partial understructure always.
- Trim ring is 12”(305mm)W and 5”(127mm)D.
- Available in two color choices of TR-K (Charcoal) or TR-FM (Snow).
- Trim ring and cover are plastic, light plate is painted steel.

Specification Tips

- Designed to work with Belong Wire Management Tray (EUWT).
- Cannot be used on Planes Training or Collaborative tables due to interference with understructures.
- Can be placed on Adaptable Worksurfaces, Planes, Planes LT, Upside, Jive C-Leg, Jive T-Leg and Compose Echo. Each product has specification restrictions, reference product specification guide.
- Belong Hatch may be retrofitted to existing worksurfaces, (with a cut sheet), that do not interfere with the understructures.

To Order, Specify:

- 1) Product number.
- 2) Trim color.

Description	Number	Price
For use with 1.18”(30mm) worksurfaces		
Cover with trim ring	EUAH-0512-AYNNS	\$30.00
Light Plate with trim ring	EUAH-0512-ANNYS	65.00
For use with 2”(51mm) worksurfaces		
Cover with trim ring	EUAH-0512-AYNNM	\$30.00
Light Plate with trim ring	EUAH-0512-ANNYM	65.00

Wire/Cable Management Accessories

Belong Hatch Planning Guidelines

Product Line	Planes	Planes LT		Upside		Compose Echo	Adaptable Worksurface	Jive Tables		
Leg Style	C-Leg (2-leg and 3-leg)	C-Leg (2-leg and 3-leg)	T-Leg	C-Leg	T-Leg	L-Leg	N/A	C-Leg	T-Leg	
Hatch Cutout Locations (From back edge of worksurface to center of hatch cutout)	9 1/8"	7 7/8"	6 1/2"	6 1 1/16"	6 1/2"	7"	6 3/4"	3 3/4"	7 1/2"	
Wire Management Tray Location	Centered on Hatch	Centered on Hatch	Centered on Hatch	Centered on Hatch and frame rails	Centered on Hatch	Centered on Hatch	Centered on Hatch	Centered on Hatch	Centered on Hatch	
⊘ Don't Widths that cannot accept Belong Hatch and Belong Wire Management Tray	46", 52" Wide	46" Wide	46" Wide	46", 52", 58" Wide Min 58", 64" for Hatch	Upside 2-Leg Rectangular 46", 52" Wide	46" Wide	24" Wide	For 24"D: 36", 42", 48", 54" Wide For 30"D: 36", 42", 48", 54" Wide (Flip Tops Not Allowed)	For 24"D: 36", 42", 48", 54" Wide For 30"D: 36", 42", 48", 54" Wide (Flip Tops Not Allowed)	
Compose Echo Screens	All	All	All	All	All	Allowed	Allowed, must match the width of a convergent worksurface	Corner and Back Screens fit all worksurfaces sizes allowed.	Corner and Back Screens fit all worksurfaces sizes allowed.	
Belong Screens	Allowed, but nominal width of screen must be 4" smaller than nominal width of Worksurface (ie 58W Worksurface needs 54W or smaller screen)	Allowed, but nominal width of screen must be 4" smaller than nominal width of Worksurface (ie 58W Worksurface needs 54W or smaller screen)	Allowed, but nominal width of screen must be 4" smaller than nominal width of Worksurface (ie 58W Worksurface needs 54W or smaller screen), 42W and 48W screens will not fit centered with tray in this location due to interference with tray mounting brackets	Nominal width of screen 2" smaller, per side, than nominal width of Worksurface (ie 58W Worksurface needs 54W or smaller screen).	Allowed, but nominal width of screen must be 2" smaller, per side, than nominal width of Worksurface (ie 58W Worksurface needs 54W or smaller screen), 42W and 48W screens will not fit centered with tray in this location due to interference with tray mounting brackets	54" or greater fits 30" base. Screens must be sized down from Worksurface size. Screen size cannot be greater than Worksurface size.	Allowed, to match the width of a convergent worksurface	Back Screens fit all worksurfaces sizes marked OK in column H	Back Screens fit all worksurfaces sizes marked OK in column H	
Belong Plus Screens	Allowed, match width of worksurface	Allowed, match width of worksurface	Allowed, match width of worksurface	Allowed, match width of worksurface	Allowed, match width of worksurface	42" fits on 30" base. 30" fits on 22" base. Screens above 42" cannot be used with wireway. Screen size cannot be greater than Worksurface size.	Allowed, to match the width of a convergent worksurface	Back Screens fit all worksurfaces sizes marked OK in column H	Back Screens fit all worksurfaces sizes marked OK in column H	
Planes Modesty Panel	54W and larger allowed, match width of worksurface, modesty nominal must be 4" smaller than nominal Worksurface width	54W and larger allowed, match width of worksurface, modesty nominal must be 4" smaller than nominal Worksurface width, 42W and 48W modestys will not fit centered with tray in this location	54W and larger allowed, match width of worksurface, modesty nominal must be 4" smaller than nominal Worksurface width, 42W and 48W modestys will not fit centered with tray in this location	54W and larger allowed, match width of worksurface, modesty nominal must be 4" smaller than nominal Worksurface width, 42W and 48W modestys will not fit centered with tray in this location	54W and larger allowed, modesty nominal must be 4" smaller than nominal Worksurface width, 42W and 48W screens will not fit centered with tray in this location	Not Allowed	Allowed to match the width of a convergent worksurface	Depths; 24" allowed, 30" Not Allowed	Widths: 60", 66", & 72" allowed All depths excluding 30" fit	
Compose Echo Modesties	Not Allowed	Not Allowed	Not Allowed	Not Allowed	Not Allowed	Allowed	Not Allowed	Not Allowed	Not Allowed	
Monitor Arms (Ergotron)	Clamp mount may be mounted to the left or right of the hatch without interference. If placing a grommet mount arm, please be aware of the understructure or mechanical components under the worksurface. If using a clamp style bracket, please refer to the usable space between the clamp and screens.	Clamp mount may be mounted to the left or right of the hatch without interference. If placing a grommet mount arm, please be aware of the understructure or mechanical components under the worksurface. If using a clamp style bracket, please refer to the usable space between the clamp and screens.	Clamp mount may be mounted to the left or right of the hatch without interference. If placing a grommet mount arm, please be aware of the understructure or mechanical components under the worksurface. If using a clamp style bracket, please refer to the usable space between the clamp and screens.	Clamp mount may be mounted to the left or right of the hatch without interference. If placing a grommet mount arm, please be aware of the understructure or mechanical components under the worksurface. If using a clamp style bracket, please refer to the usable space between the clamp and screens.	Clamp mount may be mounted to the left or right of the hatch without interference. If placing a grommet mount arm, please be aware of the understructure or mechanical components under the worksurface. If using a clamp style bracket, please refer to the usable space between the clamp and screens.	Clamp mount may be mounted to the left or right of the hatch without interference. If placing a grommet mount arm, please be aware of the understructure or mechanical components under the worksurface. If using a clamp style bracket, please refer to the usable space between the clamp and screens.	Clamp mount may be mounted to the left or right of the hatch without interference. If placing a grommet mount arm, please be aware of the understructure or mechanical components under the worksurface. If using a clamp style bracket, please refer to the usable space between the clamp and screens. monitor arms may not be mounted on the wireway when a wireway and hatch are specified.	Clamp mount may be mounted to the left or right of the hatch without interference. If placing a grommet mount arm, please be aware of the understructure or mechanical components under the worksurface. If using a clamp style bracket, please refer to the usable space between the clamp and screens.	Clamp mount may be mounted to the left or right of the hatch without interference. If placing a grommet mount arm, please be aware of the understructure or mechanical components under the worksurface. If using a clamp style bracket, please refer to the usable space between the clamp and screens.	Clamp mount may be mounted to the left or right of the hatch without interference. If placing a grommet mount arm, please be aware of the understructure or mechanical components under the worksurface. If using a clamp style bracket, please refer to the usable space between the clamp and screens.

Wire/Cable Management Accessories

Grommets

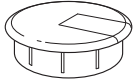

WUAC-WSG
Class CA

- Includes one grommet with removable cover.
- Must be field-installed.
- Available in black color only.

Specification Tips

- Works with top thickness 1" or greater.

To Order, Specify:

- 1) Product number.
(No finish specification required.)

Outside

Diameter	Height	Hole Size	Number	Price
3"(76mm)	1"(25mm)	2.75"(70mm)	WUAC-WSG	\$37.52



WQAG
Class IN

Features

- Includes one painted grommet with removable cover.
- Must be field-installed.

Specification Tips

- Works with top thickness:
 - WQAG-0303-PS - 1.18"(30mm) or greater
 - WQAG-0303-PM - 2"(51mm) or greater

To Order, Specify:

- 1) Product number.
- 2) Trim color.

Outside

Diameter	Height	Hole Size	Number	Trim	
				A	B
3"(76mm)	1.125"(29mm)	2.75"(70mm)	WQAG-0303-PS	\$63.92	\$77.04
3"(76mm)	2"(51mm)	2.75"(70mm)	WQAG-0303-PM	63.92	77.04



JAG-1
Class TA

- Includes one grommet with removable cover.
- Must be field-installed.
- Available in black color only.
- Works with top thickness 0.75" or greater.

To Order, Specify:

- 1) Product number.
(No finish specification required.)

Outside

Diameter	Height	Hole Size	Number	Price
2"(51mm)	0.75"(19mm)	1.75"(44mm)	JAG-1	\$29.21
3.5"(89mm)	0.75"(19mm)	3"(76mm)	JAG-2	33.69



JAG-2
Class TA



TA01-0220
Class TA

Features

- Includes one painted grommet.
- Must be field-installed.

Specification Tips

- Works with 0.75" top or greater.

To Order, Specify:

- 1) Product number.
- 2) Trim color.

Outside

Diameter	Height	Hole Size	Number	Trim	
				A	B
3"(76mm)	0.72"(18mm)	2.75"(70mm)	TA01-0220	\$53.95	\$62.26

Wire/Cable Management Accessories

Grommets

Flip Top Unit — Hatch

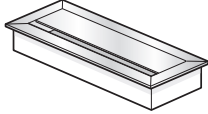

EUG1
Class TA

Features

- Includes one flip top unit hatch.
- Hatch is flush mounted with spring release cover; 0.5”(13mm) gap between cover and bezel for cords.
- Available in anodized or black finish.
- Field installed.

Specification Tips

- Specify for cord management as needed.
- Order hatch to match cutouts specified for each table.

To Order, Specify:

- 1) Product number.
(No finish specification required.)

Bezel Width	Bezel Depth	Flip Top Unit Cutout Code	Configuration	Number	Price
Anodized					
5.24”(133mm)	4.375”(111mm)	A, B	2	EUG1-0000-G2NNNW	\$266.77
8.31”(211mm)		F, V	4	EUG1-0000-G4NNNW	283.44
11.25”(286mm)		J, K	6	EUG1-0000-G6NNNW	300.13
Black					
5.24”(133mm)	4.375”(111mm)	A, B	2	EUG1-0000-G2NNNB	\$350.14
8.31”(211mm)		F, V	4	EUG1-0000-G4NNNB	366.81
11.25”(286mm)		J, K	6	EUG1-0000-G6NNNB	383.50

Electrical Accessories Resources

Surfaces Materials

Index

Warranty

Surface Materials

Finish Color Legend

Trim

Grade A

Smooth

TR-R	Beige
TR-AK	Chalk
TR-K	Charcoal
TR-C1	Cocoa
TR-J	Graphite
TR-G	Gray Tone
TR-AA	Putty
TR-E	Smoke
TR-PLS	Smooth Plaster
TR-FM	Snow

Textured

TR-TG	Grout
TR-TF	Pitch
TR-TW	Plaster

Grade B

Smooth

TR-1C	Accent Blue
TR-1G	Blue Jay
TR-1R	Brownstone
TR-1N	Night
TR-1Q	Park
TR-RR	Rusty Red
TR-1M	Sable
TR-1J	Sky Blue

Smooth Metallic

TR-MC	Metallic Champagne
TR-MG	Metallic Gunmetal
TR-LE	Metallic Silver

Textured Metallic

TR-AR	Argent
TR-HE	Hellenic

ALERT: These materials are current, however they are being considered for future obsolescence due to low volume.

Trims

TR-1E	Accent Orange
TR-1F	Accent Red
TR-CTS	Chartreuse
TR-1H	Terra
TR-1K	Wren

Index

Products are listed alphabetically in this index by alpha-numeric prefix/suffix codes.

Product Code	Product Description	Page
4TJC-72	Wire/Cable Management — Horizontal – J-Channel	.97
AKWN	Wire/Cable Management — Horizontal – Height Adjustable Table	.96
CPVC-1	Wire Manager — Vertical	.99
EDUX-3000-B	Worksurface Power Modules — Other Power and Data – Retrofit USB Charging Cable	.93
EUAC	Wire/Cable Management — Vertical – Cord Management Cuff	.98
EUAH-0512	Wire/Cable Management Accessories – Belong Hatch	.101
EUAM-0000	Wire/Cable Management Accessories – Clips — Conduit Clamp	.100
EUAW	Wire/Cable Management — Vertical – Mesh Cord Manager with Cuffs	.98
EUAW-NH	Wire/Cable Management — Horizontal – Wire Manager — Horizontal	.96
EUB1-HLOB-2100	Worksurface Power Modules — Flush Mounted Power – Hardwire	.77
EUB1-HLOB-2110	Worksurface Power Modules — Flush Mounted Power – Hardwire	.77
EUB1-HLOB-2112	Worksurface Power Modules — Flush Mounted Power – Hardwire	.77
EUB1-PL0B-2100	Worksurface Power Modules — Flush Mounted Power – Corded	.74
EUB1-PL0B-2110	Worksurface Power Modules — Flush Mounted Power – Corded	.74
EUB1-PL0B-2112	Worksurface Power Modules — Flush Mounted Power – Corded	.74
EUB1-PL0B-4000	Worksurface Power Modules — Flush Mounted Power – Corded	.74
EUB1-SFOB-2100	Worksurface Power Modules — Flush Mounted Power – Spiral Cord for Height Adjustable	.80
EUB1-SFOB-2110	Worksurface Power Modules — Flush Mounted Power – Spiral Cord for Height Adjustable	.80
EUB1-SFOB-2112	Worksurface Power Modules — Flush Mounted Power – Spiral Cord for Height Adjustable	.80
EUB1-SFOB-4000	Worksurface Power Modules — Flush Mounted Power – Spiral Cord for Height Adjustable	.80
EUB1-SLOB-2100	Worksurface Power Modules — Flush Mounted Power – Worksurface Power Modules—Flush Mounted Power	.83
EUB1-SLOB-2110	Worksurface Power Modules — Flush Mounted Power – Worksurface Power Modules—Flush Mounted Power	.83
EUB1-SLOB-2112	Worksurface Power Modules — Flush Mounted Power – Worksurface Power Modules—Flush Mounted Power	.83
EUB1-SLOB-4000	Worksurface Power Modules — Flush Mounted Power – Worksurface Power Modules—Flush Mounted Power	.83
EUB5	Worksurface Power Modules – Belong — Power Suite	.17
EUB5-BIN1	Worksurface Power Modules – Belong Power 65W — Power Suite	.15
ECU1-HFOP-200000	Worksurface Power Modules — Flip Top – Smooth Bezel — Hardwire — Single-Sided — Power, Data and USB	.46
ECU1-HFOP-210010	Worksurface Power Modules — Flip Top – Smooth Bezel — Hardwire — Single-Sided — Power, Data and USB	.46
ECU1-HFOP-311010	Worksurface Power Modules — Flip Top – Smooth Bezel — Hardwire — Single-Sided — Power, Data and USB	.46
ECU1-PFOP-200000	Worksurface Power Modules — Flip Top – Smooth Bezel – Corded – Single-Sided — Power, Data and USB	.40
ECU1-PFOP-210010	Worksurface Power Modules — Flip Top – Smooth Bezel – Corded – Single-Sided — Power, Data and USB	.40
ECU1-PFOP-311010	Worksurface Power Modules — Flip Top – Smooth Bezel – Corded – Single-Sided — Power, Data and USB	.40
ECU1-PFOP-400000	Worksurface Power Modules — Flip Top – Smooth Bezel – Corded – Single-Sided — Power, Data and USB	.40
ECU2-HFOP-210010	Worksurface Power Modules — Flip Top – Smooth Bezel — Hardwire — Single-Sided — Power, Data and USB	.49
ECU2-HFOP-311010	Worksurface Power Modules — Flip Top – Smooth Bezel — Hardwire — Single-Sided — Power, Data and USB	.49
ECU2-PFOP-210010	Worksurface Power Modules — Flip Top – Smooth Bezel — Corded — Double-Sided — Power, Data and USB	.43
ECU2-PFOP-311010	Worksurface Power Modules — Flip Top – Smooth Bezel — Corded — Double-Sided — Power, Data and USB	.43
ECU2-PFOP-400000	Worksurface Power Modules — Flip Top – Smooth Bezel — Corded — Double-Sided — Power, Data and USB	.43
ECU4	Worksurface Power Modules – Power Cube	.17
ECU4-BIN1	Worksurface Power Module – Belong Power 65W — Power Cube	.14
EUCB-TJP	Worksurface Power Modules – Power Cube and Power Suite — Brackets	.18
EUCB-WFP	Worksurface Power Modules – Power Cube and Power Suite — Brackets	.18
EUCB-WJP	Worksurface Power Modules – Power Cube and Power Suite — Brackets	.18
EUCN-PJ	Worksurface Power Modules — Other Power and Data – Collaborative Power Station	.92
EUD1-HFOB-2010	Worksurface Power Modules — Enhanced Power – Hardwire	.28
EUD1-HFOB-2110	Worksurface Power Modules — Enhanced Power – Hardwire	.28
EUD1-HFOB-2112	Worksurface Power Modules — Enhanced Power – Hardwire	.28
EUD1-PF0B-2010	Worksurface Power Modules — Enhanced Power – Corded	.23
EUD1-PF0B-2110	Worksurface Power Modules — Enhanced Power – Corded	.23
EUD1-PF0B-2112	Worksurface Power Modules — Enhanced Power – Corded	.23
EUD1-PF0B-4000	Worksurface Power Modules — Enhanced Power – Corded	.23

Index

Product Code	Product Description	Page
EUD1-SFOB-2110	Worksurface Power Modules — Enhanced Power — Spiral Corded — Height Adjustable	33
EUD1-SFOB-4000	Worksurface Power Modules — Enhanced Power — Spiral Corded — Height Adjustable	33
EUD1-SLOB-2110	Worksurface Power Modules — Enhanced Power — Cord for Height Adjustable	34
EUD1-SLOB-4000	Worksurface Power Modules — Enhanced Power — Cord for Height Adjustable	34
EUDB-0000-H	Worksurface Power Modules — Enhanced Power — Brackets — AboveWorksurface — Adjustable	35
EUDB-0000-N	Worksurface Power Modules — Enhanced Power — Brackets — AboveWorksurface — Adjustable for Knife Edge	35
EUDB-0000-T	Worksurface Power Modules — Enhanced Power — Brackets — Above Worksurface — Adjustable with Tackboard Offset	36
EUDB-0000-U	Worksurface Power Modules — Enhanced Power — Brackets — UnderWorksurface — Fixed	37
EUDB-0000-W	Worksurface Power Modules — Enhanced Power — Brackets — Above Worksurface — Fixed	36
EUDB-J	Worksurface Power Modules — Enhanced Power — Brackets — For Use with X Series	37
EUDX-3000-B	Worksurface Power Modules — Other Power and Data — Cables	93
EUDX-H000-B	Worksurface Power Modules — Other Power and Data — Cables	93
EUDX-V000-B	Worksurface Power Modules — Other Power and Data — Cables	93
EUE1-000B	Worksurface Power Modules — Flip Top — Non-Powered	53
EUE1-1111W	Worksurface Power Modules — Flip Top — Power and Data	52
EUE1-1331W	Worksurface Power Modules — Flip Top — Power and Data	52
EUE1-C331W	Worksurface Power Modules — Flip Top — Power and Data	52
EUE1-HFOB-1212	Worksurface Power Modules — Flip Top — Hardwire — Single-Sided — Power, Data and USB	64
EUE1-HFOB-2110	Worksurface Power Modules — Flip Top — Hardwire — Single-Sided — Power, Data and USB	64
EUE1-PFOB-1212	Worksurface Power Modules — Flip Top — Corded — Single-Sided — Power, Data and USB	54
EUE1-PFOB-2110	Worksurface Power Modules — Flip Top — Corded — Single-Sided — Power, Data and USB	54
EUE1-PFOB-4000	Worksurface Power Modules — Flip Top — Corded — Single-Sided — Power, Data and USB	54
EUE2-000B	Worksurface Power Modules — Flip Top — Non-Powered	53
EUE2-1331W	Worksurface Power Modules — Flip Top — Power and Data	52
EUE2-C331W	Worksurface Power Modules — Flip Top — Power and Data	52
EUE2-HFOB-2110	Worksurface Power Modules — Flip Top — Hardwire — Double-Sided — Power, Data and USB	69
EUE2-HFOB-1212	Worksurface Power Modules — Flip Top — Hardwire — Double-Sided — Power, Data and USB	69
EUE2-PFOB-1212	Worksurface Power Modules — Flip Top — Corded — Double-Sided — Power, Data and USB	59
EUE2-PFOB-2110	Worksurface Power Modules — Flip Top — Corded — Double-Sided — Power, Data and USB	59
EUE2-PFOB-4000	Worksurface Power Modules — Flip Top — Corded — Double-Sided — Power, Data and USB	59
EUEA-CABR	Wire/Cable Management — Vertical — Mesh Cord Manager Bracket	98
EUET-0000-1M3N	Worksurface Power Modules — Power Tap — Hardwire and Corded — Corded	89
EUET-0030-2M3N	Worksurface Power Modules — Power Tap — Horizontal	87
EUET-0030-3M3N	Worksurface Power Modules — Power Tap — Horizontal	87
EUET-0030-4M3N	Worksurface Power Modules — Power Tap — Horizontal	87
EUET-0030-CM3N	Worksurface Power Modules — Power Tap — Hardwire and Corded — Hardwire	89
EUF1-PFOB	Worksurface Power Modules — Classic Power — Classic Power Module	38
EUFB-0000-AB	Worksurface Power Modules — Classic Power — Brackets — Angled	39
EUFB-0000-SB	Worksurface Power Modules — Classic Power — Brackets — Vertical	39
EUFB-0000-UB	Worksurface Power Modules — Classic Power — Brackets — Under Surface	39
EUG1	Wire/Cable Management Accessories — Grommets — Flip Top Unit — Hatch	104
EUP1-HF	Worksurface Power Modules — Flush Mounted Power — Round	86
EUP1-PF	Worksurface Power Modules — Flush Mounted Power — Round	86
EUPB-TJP	Worksurface Power Modules — Belong Power 65W — Plug Strip Brackets	16
EUPB-WFP	Worksurface Power Modules — Belong Power 65W — Plug Strip Brackets	16
EUPB-WJP	Worksurface Power Modules — Belong Power 65W — Plug Strip Brackets	16
EUR1	Worksurface Power Modules — Belong — Plug Strip	17
EUR1-BIN1	Worksurface Power Module — Belong Power 65W — Plug Strip	14
EURT-0000-N001CB	Worksurface Power Modules — Other Power and Data — Data Bezel	91
EURT-0000-N001CB	Worksurface Power Modules — Other Power and Data — Data Bezel	91
EURT-0000-N001CW	Worksurface Power Modules — Other Power and Data — Data Bezel	91

Index

Product Code	Product Description	Page
EURT-0000-N001SW	Worksurface Power Modules — Other Power and Data – Data Bezel	.91
EURT-0072-1010	Worksurface Power Modules — Other Power and Data – Bezel Utility Module	.91
EURT-0072-1100	Worksurface Power Modules — Other Power and Data – Bezel Utility Module	.91
EUS1-HLOB	Worksurface Power Modules — Enhanced Power – Seamless	.20
EUS1-HLOW	Worksurface Power Modules — Enhanced Power – Seamless	.20
EUS1-PFOB	Worksurface Power Modules — Enhanced Power – Seamless	.20
EUUB-UP	Worksurface Power Modules – Power Cube and Power Suite — Brackets	.18
EUWC-HLOB	Worksurface Power Modules – Wireless Charging Module	.19
EUWC-HLOW	Worksurface Power Modules – Wireless Charging Module	.19
EUWC-PFOB	Worksurface Power Modules – Wireless Charging Module	.19
EUWC-PFOW	Worksurface Power Modules – Wireless Charging Module	.19
EUWT	Wire/Cable Management — Horizontal – Wire Management Tray	.95
JAG-1	Wire/Cable Management Accessories – Grommets	.103
JAG-2	Wire/Cable Management Accessories – Grommets	.103
NECG-V	Wire/Cable Management — Vertical – Vertical Cable Guide	.99
NEH-8	Wire/Cable Management Accessories – Clips — Wire Management Loop	.100
TA01-0220	Wire/Cable Management Accessories – Grommets	.103
TA01-0225	Wire/Cable Management Accessories – Clips — Wire Manager Clips	.100
TABC	Wire/Cable Management — Horizontal – Basket Cover	.96
TAWB	Wire/Cable Management — Horizontal – Wire Management Basket	.96
TYVW	Wire/Cable Management — Vertical – Vertical Wire Channel - Leg Attached	.99
WQAG	Wire/Cable Management Accessories – Grommets	.103
WUAC-WSG	Wire/Cable Management Accessories – Grommets	.103
WUAW-PNH	Wire/Cable Management — Horizontal – Horizontal Wire Management	.97
ZUAP-0000-PAN	Worksurface Power Modules — Power Tap – Brackets — Adjustable	.90
ZUAP-0000-PFD	Worksurface Power Modules — Power Tap – Brackets — Fixed	.90
ZUAP-0000-PGH	Worksurface Power Modules — Power Tap – Brackets — Bracket with Grommet	.90
ZUAP-000-PUR	Worksurface Power Modules — Power Tap – Brackets — Under Surface	.90

Product Compatibility and Limited Warranty Policy

Great Expectations

You have them as a Haworth customer and so do we. And because we value our customers, we cover our products with the Haworth North America Product Compatibility and Limited Warranty Policy.

Our Commitment To Product Compatibility – Integrated Product Platforms

As a market leader in the design and manufacture of workspaces that adapt to change, we strive to maintain product compatibility within our various generations of integrated product platforms. This benefits the customer who desires to update or modify their work environment. It also benefits the customer needing to replace a product due to damage or other reasons but which is no longer manufactured or is otherwise unavailable, such as a fabric or finish that is discontinued because of changing market preferences. In both circumstances, we often can provide products with comparable function and performance.

Our Commitment To Product Quality – The Haworth North America Limited Warranty

To ensure customer satisfaction and peace of mind, we stand behind our products with the Haworth North America Limited Warranty. To review the current version of the limited warranty including its terms and conditions, please go to:

www.haworth.com/warranty or contact OneTouch@Haworth.com or 1 877 429 6784.

Warranty Requests or Questions

For questions or service requests pertaining to the Haworth Limited Warranty, please contact your Haworth dealer.

If you are unsure who your dealer is, please contact **OneTouch@Haworth.com or 1 877 429 6784.**

Terms of Sale

The Terms of Sale apply to all products in the North America Price Lists. To review the current version of the North American Terms of Sale, please go to:

www.haworth.com/terms-of-sale or contact OneTouch@Haworth.com or 1 877 429 6784.

HAWORTH

HAWORTH® is a registered trademark of Haworth, Inc.

© Haworth, Inc. All rights reserved. 2025 2.25

haworth.com | 800 344 2600