

HAWORTH

Nia Sales Presentation

Asia Pacific
2024

Content

- Value Proposition
- Statement of Line
- Functions
- Colors and Materials
- Applications
- Certificates and Awards

Value Proposition

HAWORTH

World of work is constantly changing

Office spaces have become more and more versatile to accommodate different tasks and behaviours of changing workforces.

Flexible working practices have increased the number and variety of non-assigned workspaces and added complexity to workspace design.



Traditional vs Agile work

Agile workers don't want to spend time adjusting the task chair they only spend a few hours in. The ideal work environment for tomorrow's knowledge worker provides support where it's needed and freedom where it's wanted.

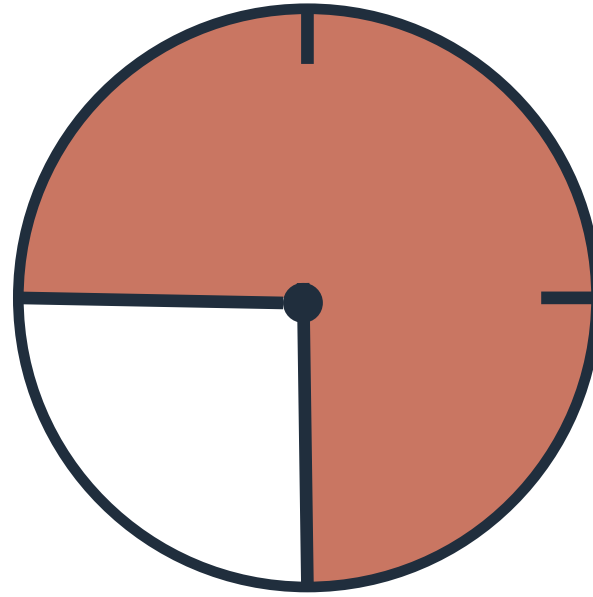

9 h Focus work
at assigned
workplace

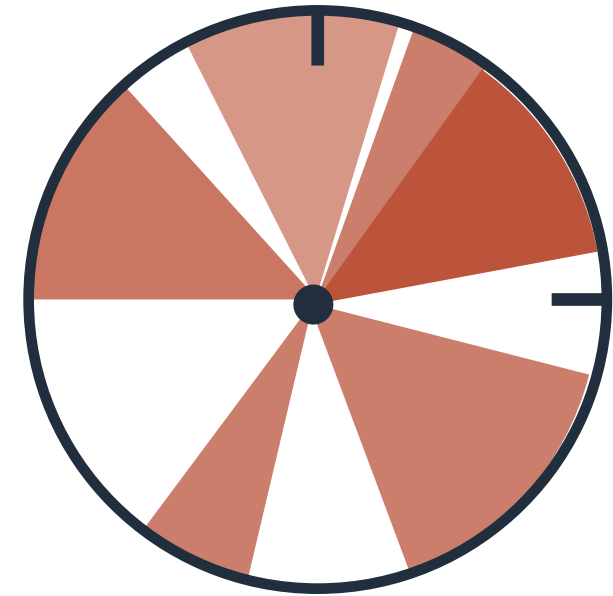

2h meeting
1,5 h conference call
20 min conversation
over coffee
1,5 h silent focus work
2h workshop

Why Active Seating?

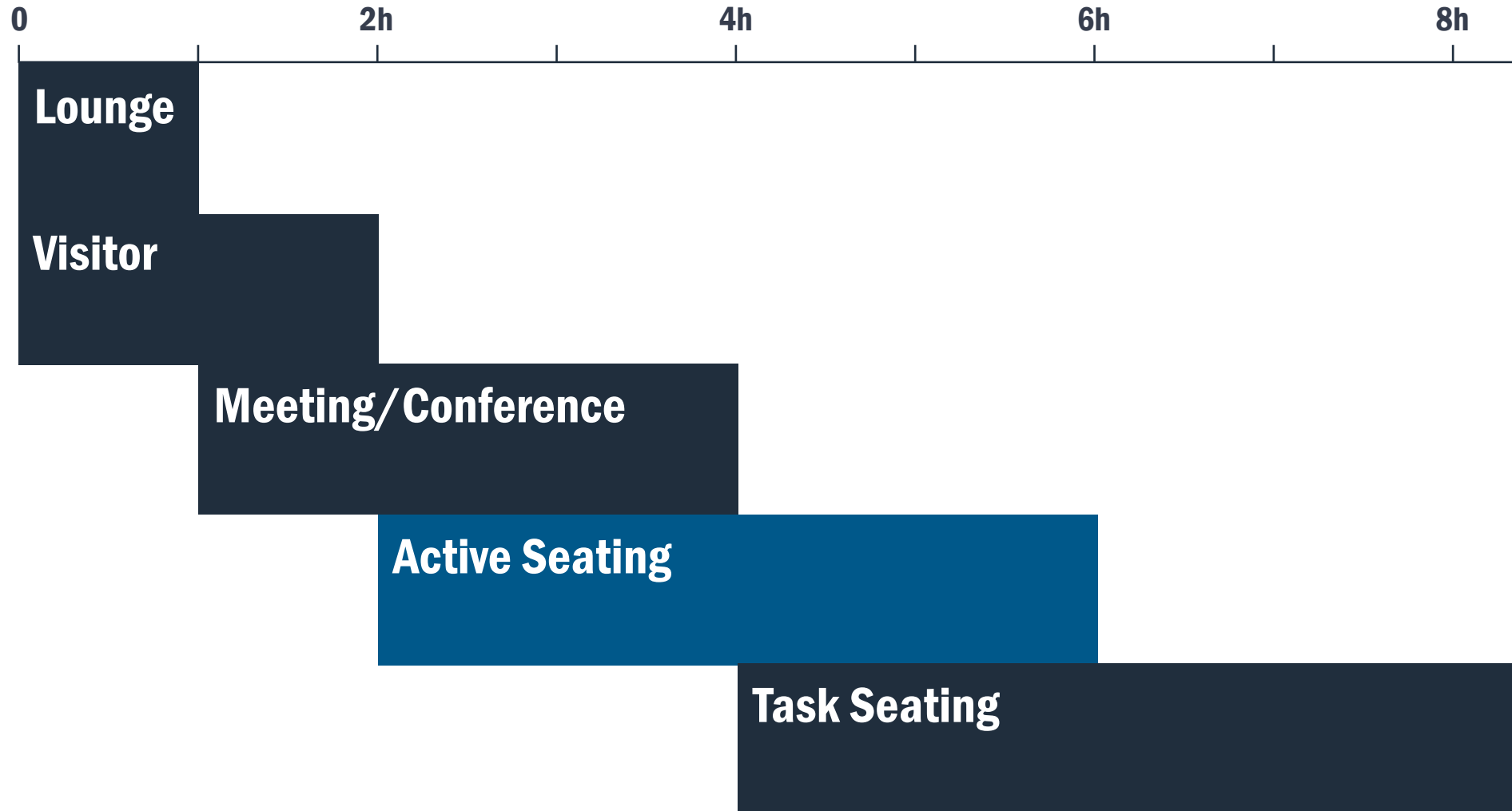

Why Nia?

Nia was conceived with the needs of an increasingly agile global workforce in mind:

Redefining work seating

Traditional task chairs contrast the increasingly residential-themed workplace aesthetic. Nia with its slim upholstered profile and concealed mechanisms finally create a chair that compliments this aesthetic without compromising performance

Freedom as wanted, support as needed

Nia's weight-activated mechanism and unique pivoting back accommodate and quickly adapt to users postures without complicated adjustment controls.

So many opportunities

Nia is designed to blend the style and comfort of lounge chair with the performance of a task chair, creating a solution for many different work settings, from meeting/conference rooms, focus work areas and collaboration zones.

NIA



Statement of Line

HAWORTH

Nia Statement of Line

As diverse as its users,
designed for every workstyle
and every possible application
in the workplace.



High back
Back height 650mm



Mid back
Back height 555mm



Stool
Back height 555mm



Statement of Line

Arms

Armless
 Fixed (+)
 Height adjustable Arms (+)

Mechanism

Synchronized weight activated
 Seat height adjustment
 Backrest fixation

Castors

Hard castors
 Soft castors



Upholstered Back

High back (+) – 650mm
 Mid back – 555 mm

Backrest Mechanism

Without
 With (+)

Seat pan

Comfort foam

Base

Aluminium
 Plastic*
 Stool

(+) optional
 * Available soon

Statement of Line (+) Height adjustable arms



(+) optional

HAWORTH

Key features

- Simple, intuitive adjustment
- Smart, unique patented mechanism
- Supports a wide variety of postures
- Designed by brodbeck design and Haworth Design Studio



Functions

HAWORTH

Seat height adjustment

Pneumatic seat height adjustment.

Seat height adjusts 120 mm from 440 mm to 560 mm on standard models

Seat height adjusts 229 mm from 590 mm to 819 mm on stools.

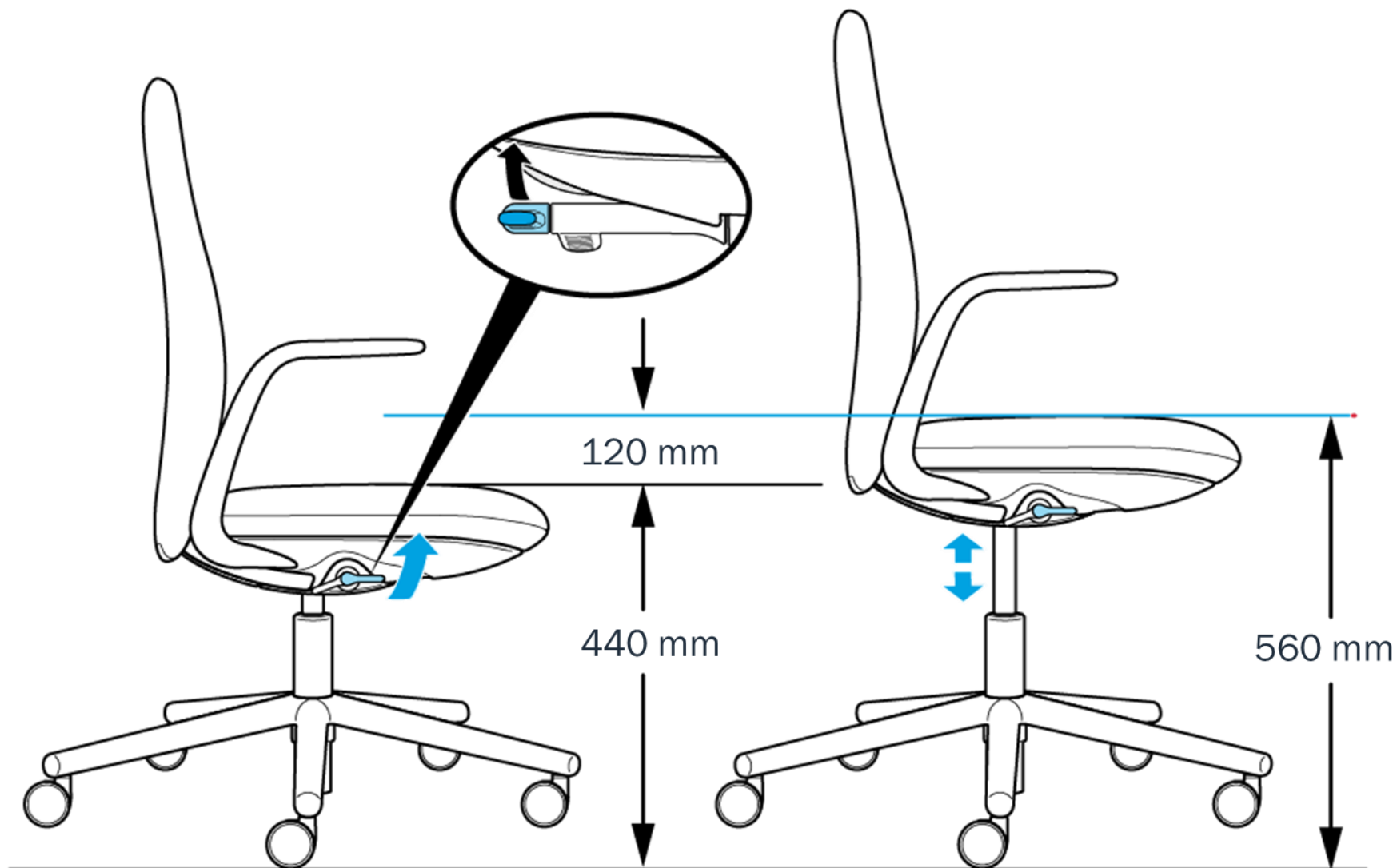

HAWORTH

Back lock

Single position back lock to fix the backrest in the upright position. In total there are 5 back rest positions to fix.

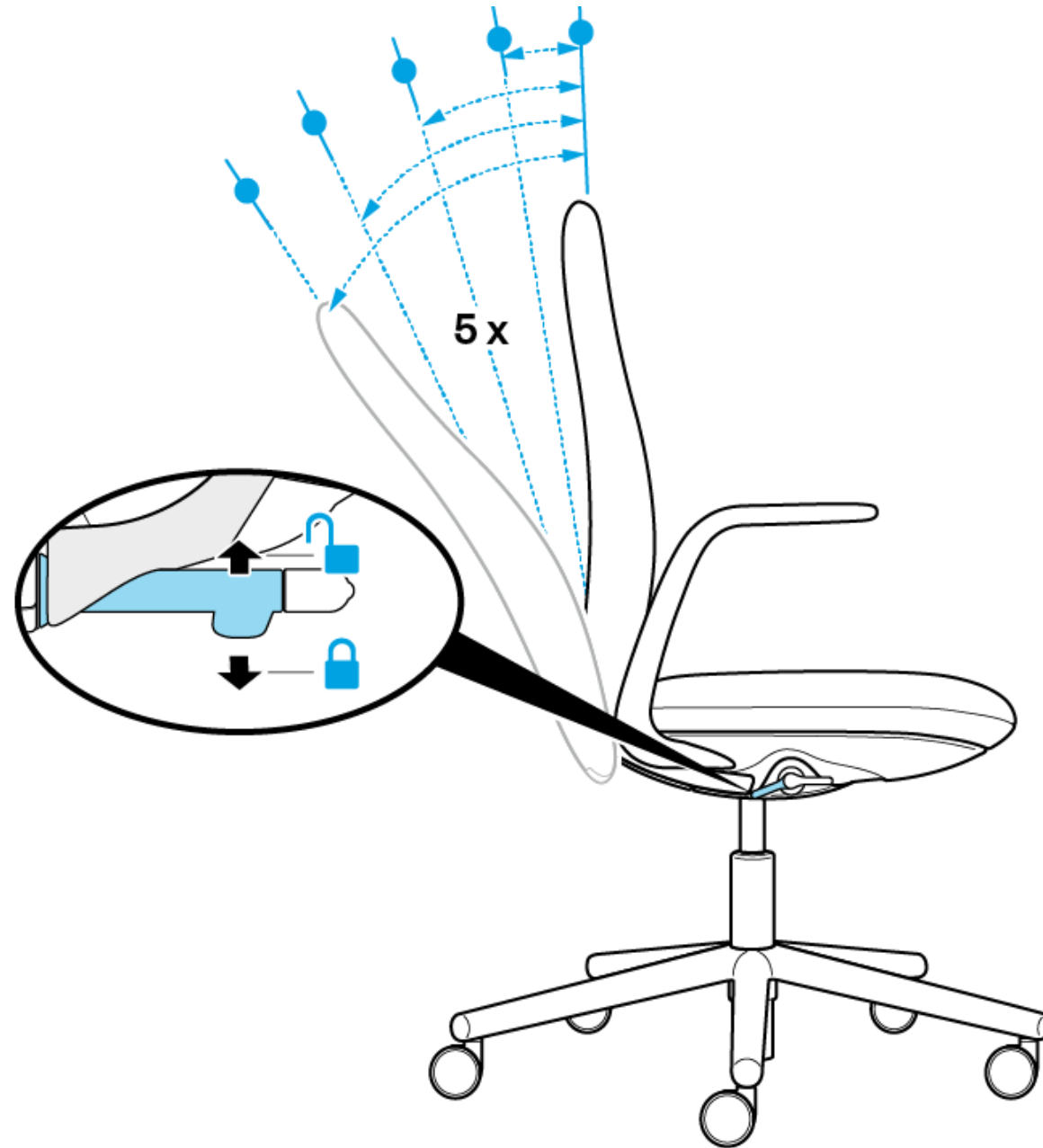

HAWORTH

Pivoting Mechanism (Optional)

Pivoting mechanism is self adjusting and moves in combination with the seating mechanism to create 360° movement.

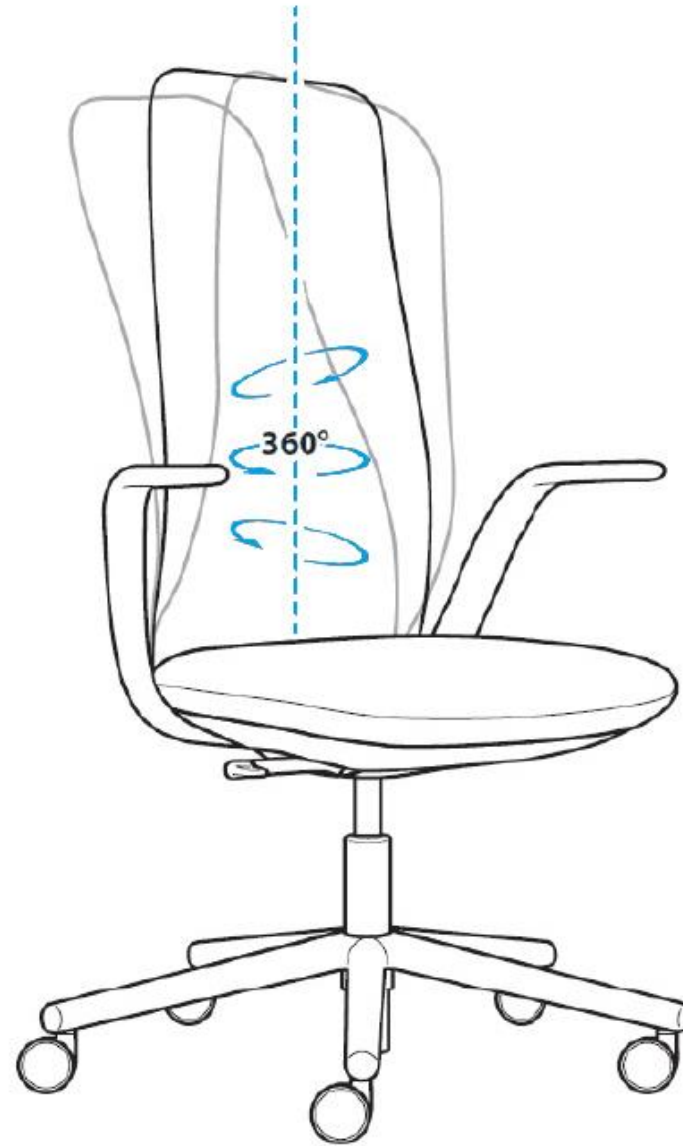

Height Adjustable arms

Height-adjustable armrests support the musculature of the neck and shoulders when it's set properly. Grasp the armrest and slide the armrest up or down as needed.

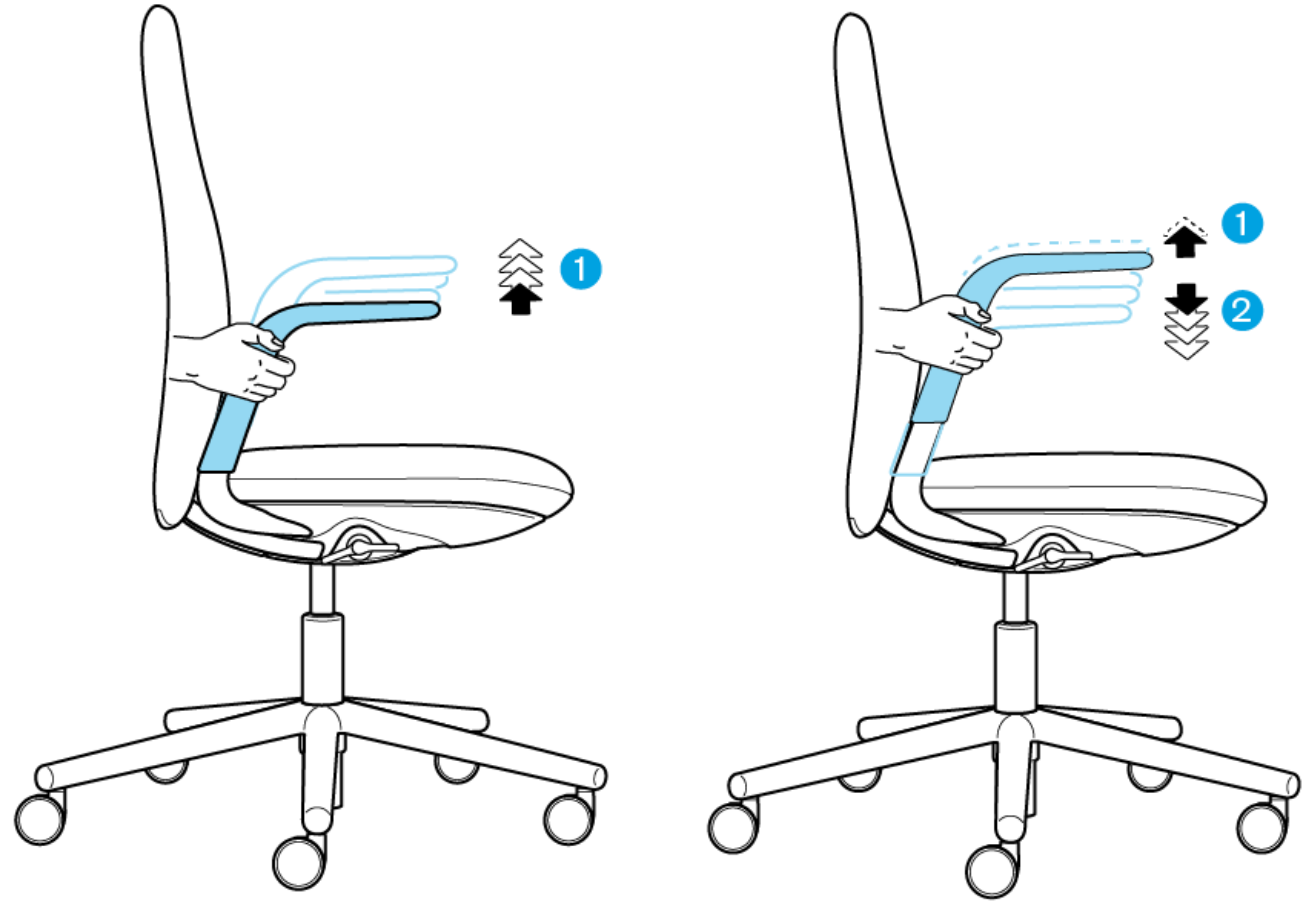

Colors and Materials

HAWORTH

Colours & Materials Seat & Back upholstery



Tellure



Horizon

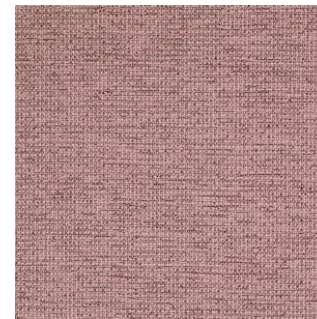

Mozart

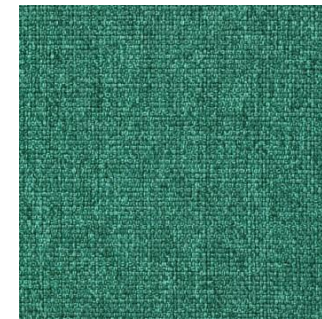

Medley



Focus

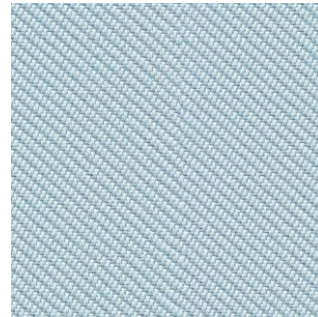

Oceanic



Diagonale



Blazer



Relate

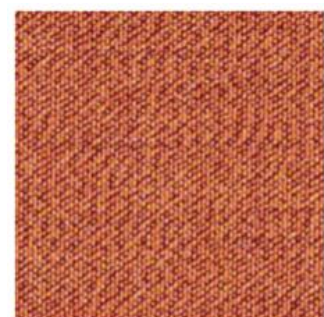

Atlas



Remix 3



Divina Melange 3

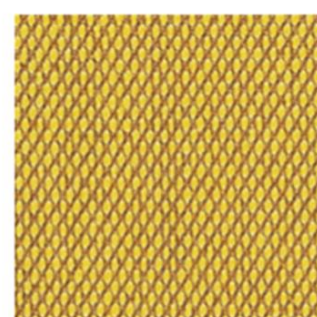

Steelcut Trio 3

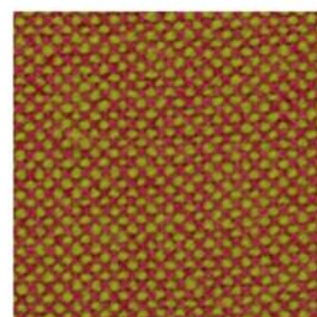

Hallingdal 65

HAWORTH

Colours & Materials Finishes

Plastic Frame



Black

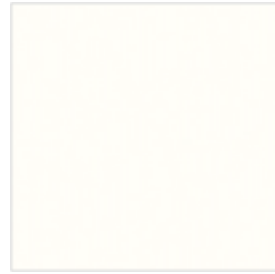

Smooth Plaster

Aluminum Base

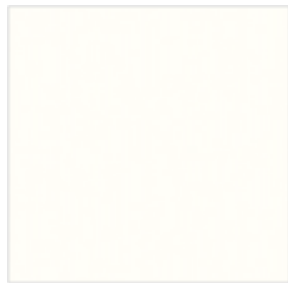

Matte EU White



Matte EU Black

Applications

HAWORTH

Workshop



HAWORTH

**Focus Work
unassigned**



HAWORTH

Focus work
assigned



HAWORTH

Meeting



HAWORTH

Meeting



HAWORTH

Homeoffice



Certificates and Awards

Certificates and awards

- BIFMA x5.1
- AFRDI
- GECA
- BIFMA Level 2
- Indoor Advantage™ Gold
- IF Design Award



Thank you!