

HAWORTH

WORKSTATIONS INSPIRATION LAYOUTS

Haworth Application Design Team - 2023



INDEX

PRICE

- \$ (\$20 - \$35k)..... SIF's -
- \$\$ (\$35k - \$50k)..... SIF's -
- \$\$\$ (\$50k & above)..... SIF's -

LAYOUT TYPE

- Benching..... SIF's -
- Panel Based..... SIF's -
- Storage Based..... SIF's -

Overall typical price does not include task seating, ancillary, or architectural interiors. Architectural interiors product shown is used for rendering purposes only. Validate before order entry.



WORKSTATIONS | Showroom - \$\$\$



Key Design Features

- Knife edge detail
- Laminate center screen for seated privacy
- Dual height table range adjustment
- Lower height storage to accommodate height adjustable benching

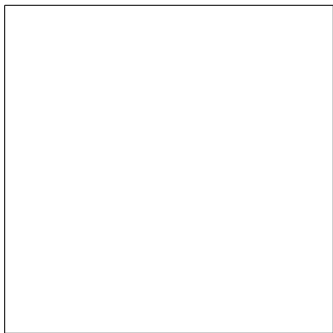
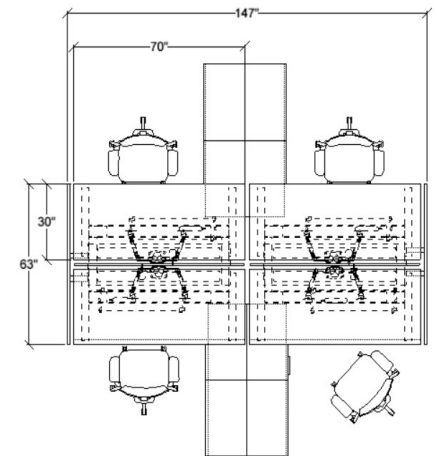

Worksurfaces - Linen



Storage & Screen - Field Elm

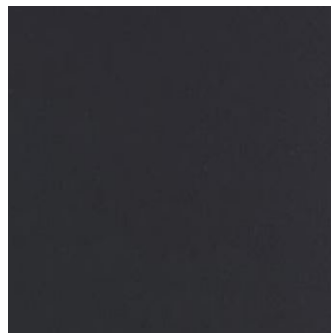

Trim - Charcoal



Cushion Top - Cotswold, Soft Charcoal

WORKSTATIONS | Showroom - \$\$



Key Design Features

- Height adjustable benching
- Wire management
- Mobile storage with cushion top
- Table mounted privacy screens

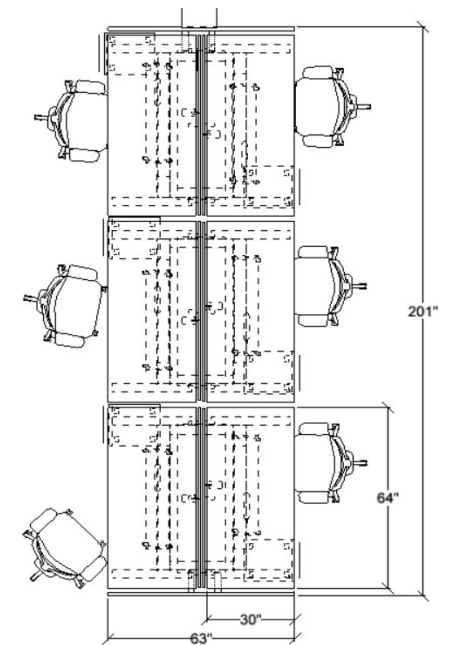

Worksurfaces - Linen

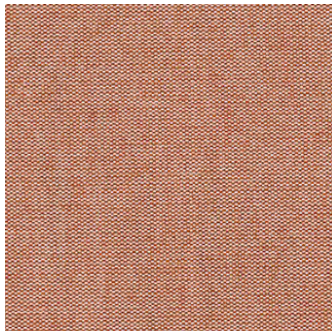

Screen - Camp, Campfire (RR)

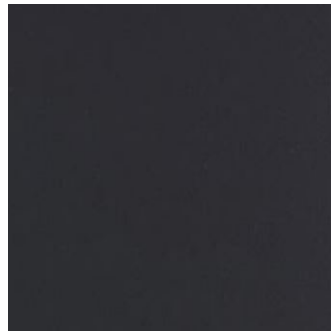

Trim - Charcoal

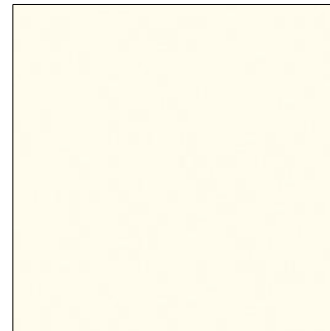

Storage - Smooth Plaster

WORKSTATIONS | Showroom - \$



Key Design Features

- 21”H Privacy Screen
- Benching worksurface ender
- Territory privacy screen
- Screen mounted work tools

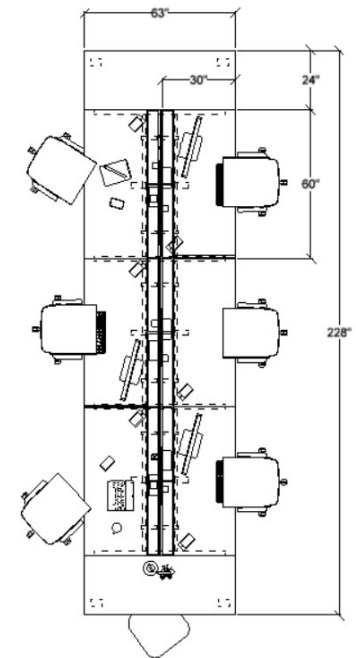

Worksurfaces - Phantom Ecu



Screen - Chevron,
Featherstitch (RR)

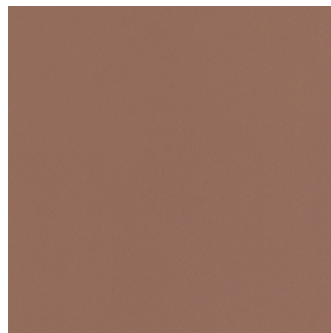

Trim - Terra

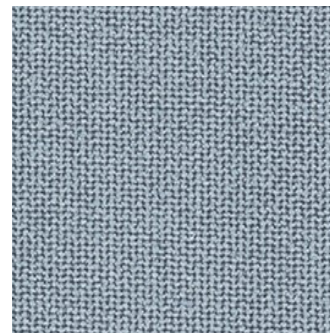

Territory Screen - Novelty, Illusion

WORKSTATIONS | Showroom - \$



Key Design Features

- Angled legs
- Attached storage ends
- Dual-sided mounted storage

Active Components Open Dual Sided Nook & Ender was discontinued 10/10/2023, please reference catalogs for alternate solutions.

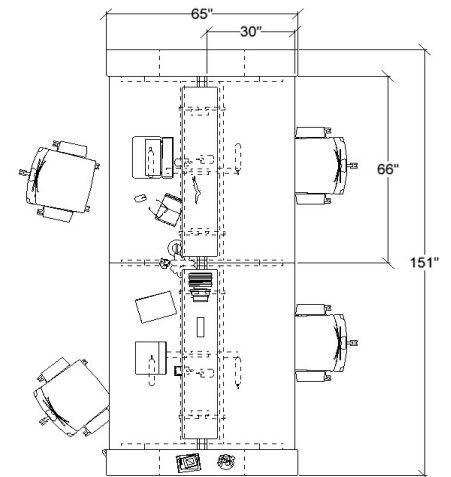

Worksurfaces - Phantom Pearl



Trim - Metallic Gunmetal

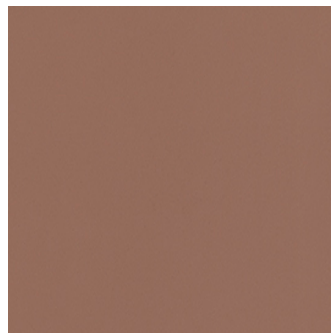

Trim Accent - Terra

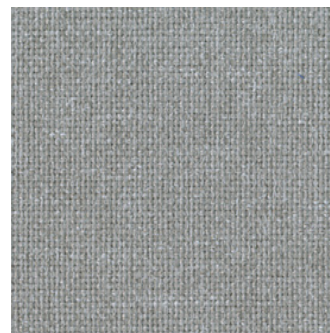

Cushion Top - Blanket, Yawn

WORKSTATIONS | Showroom - \$\$



Key Design Features

- Panel mounted center screen
- Mobile storage
- Corner privacy screen

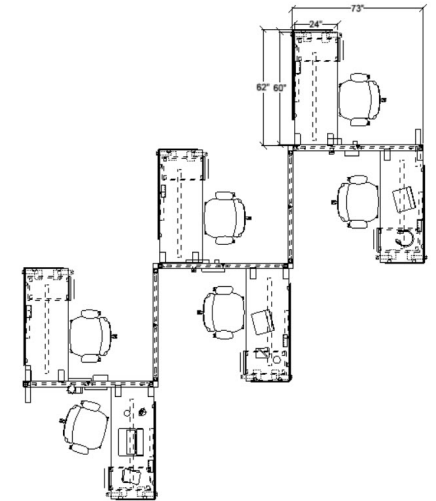

Worksurfaces - Phantom Ecu



Screen - Camp, Cot (RR)



Trim - Charcoal

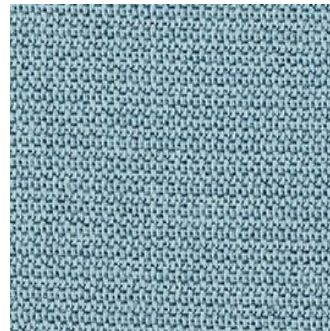

Desk Screen - Sisal, Knotweed

WORKSTATIONS | Showroom - \$



Key Design Features

- Programmable paddle
- Height adjustable table mounted storage
- Table mounted privacy screens
- Belong power suite + wire management

Active Components Open Pedestal was discontinued 10/10/2023, please reference catalogs for alternate solutions.

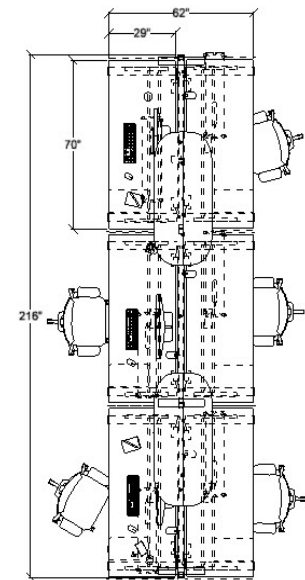

Worksurfaces - Putty



Panel - Chevron,
Featherstitch (RR)

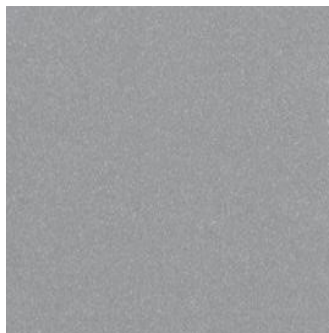

Trim - Metallic Silver

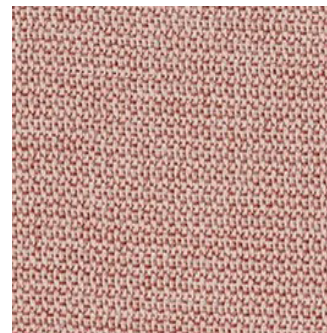

Screen - Sisal, Rubia

WORKSTATIONS | Showroom - \$



Key Design Features

- Programmable paddle on height adjustable table
- Open & closed storage
- Panel mounted center screen
- Desk mounted power

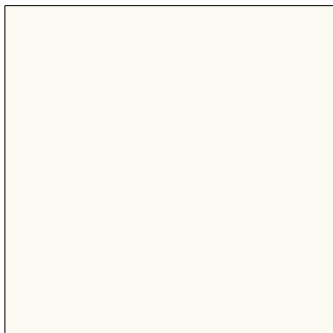
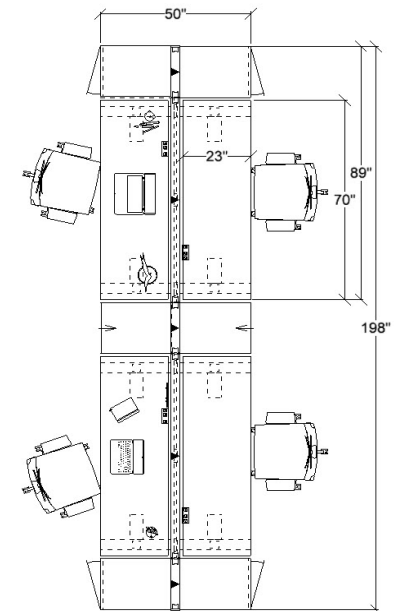

Worksurfaces - Linen



Panel & Screen - Scapes, Valley (RR)

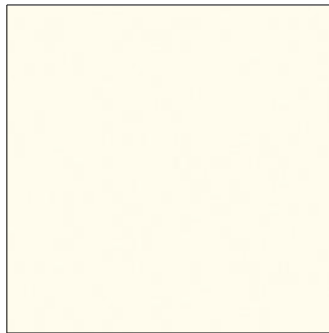

Trim - Smooth Plaster

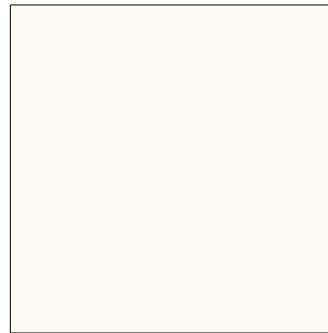

Storage - Linen

WORKSTATIONS | Showroom - \$\$



Key Design Features

- Open Credenza for HAT Leg integration
- Wire management
- Table mounted privacy screen
- Panel mounted center screen with accessory rail

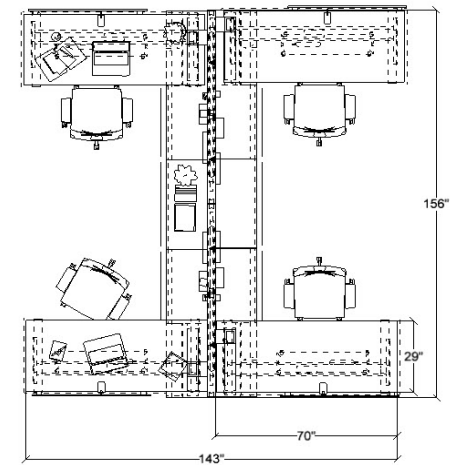

Worksurfaces - Drift



Center Screen - Kio, Jib (RR)

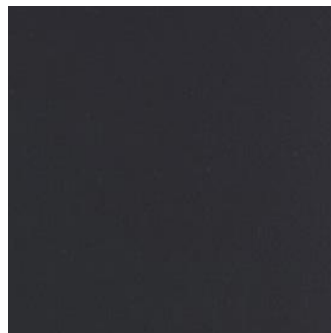

Trim - Charcoal

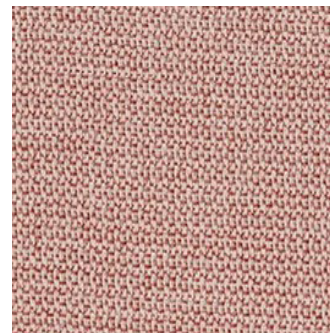

Desk Mounted Screen - Sisal, Rubia

WORKSTATIONS | Showroom - \$



Key Design Features

- 14"H privacy screens
- Storage on legs
- Mixed storage configurations
- Belong power suite for each user

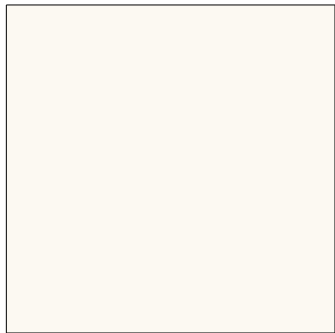
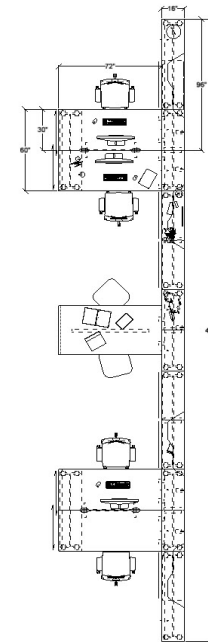

Worksurfaces - Linen

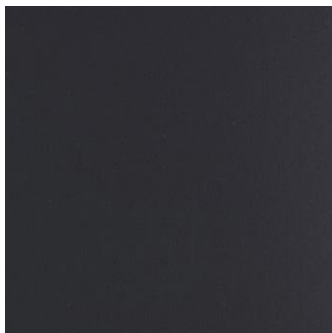

Storage - Charcoal

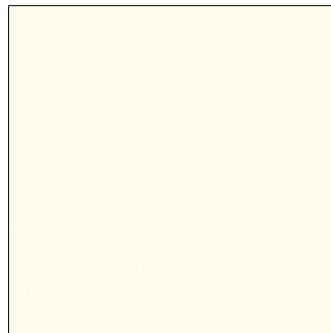

Trim - Smooth Plaster

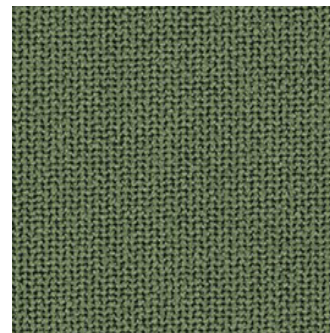

Screen - Novelty, Snazzy

WORKSTATIONS | Showroom - \$\$\$



Key Design Features

- Frameless frosted glass for privacy
- Dual purpose low storage
- Above worksurface systems panel power
- Territory screen

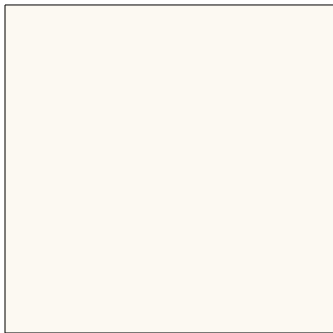
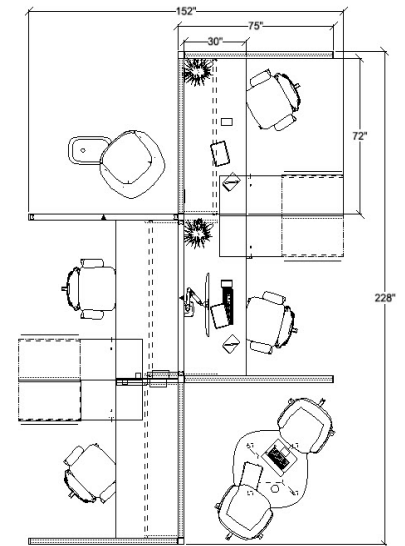

Worksurfaces - Linen



Panel - Phantom Ecru



Panel - Chevron, Gillwork (RR)

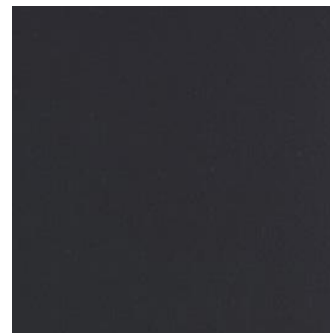

Trim - Charcoal

WORKSTATIONS | Showroom - \$



Key Design Features

- T-base design on height adjustable table
- Gallery end panel
- Mobile storage
- Belong power suite

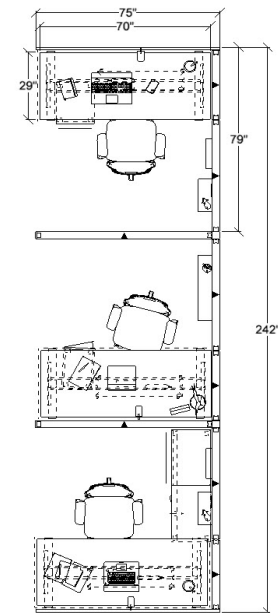

Worksurfaces - Hay

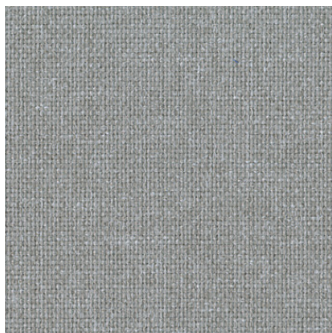

Panel - Blanket, Yawn (RR)

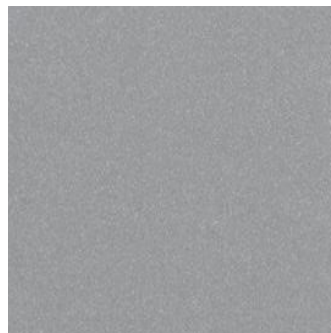

Trim - Metallic Silver

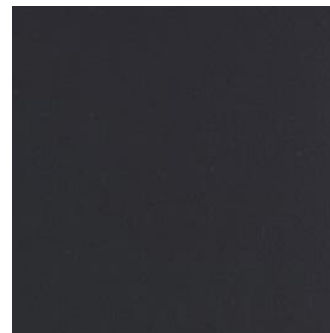

Gallery Panel & Storage - Charcoal

WORKSTATIONS | Showroom - \$\$



Key Design Features

- Top mounted dual-sided overhead storage
- Personal wardrobe tower
- Mobile storage credenza
- Slat tile

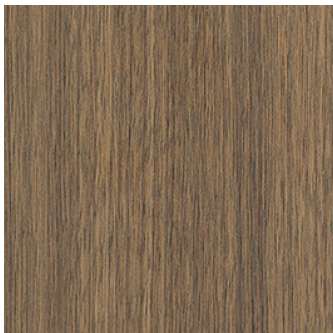
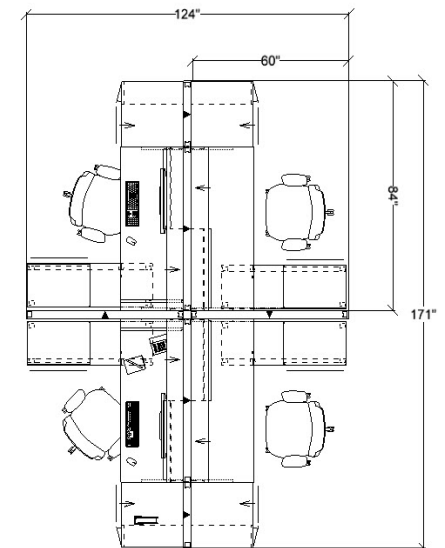

Worksurfaces & Storage Fronts - Neo Walnut



Panels - Chevron, Featherstitch

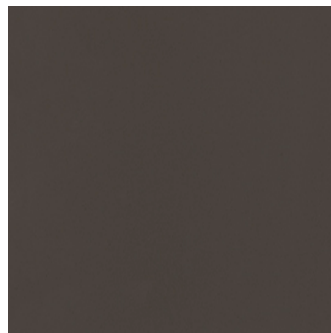

Trim - Brownstone

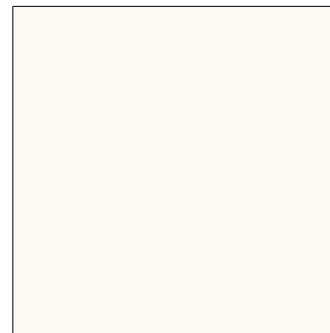

Storage - Linen

WORKSTATIONS | Showroom - \$



Key Design Features

- Tethered mobile height adjustable table
- Footrest & open storage on height adjustable table
- 120-degree panel configuration
- Glass topper

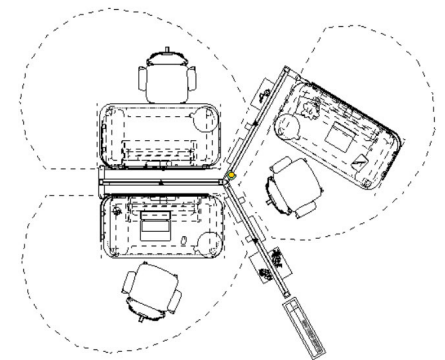

Worksurfaces - Hay

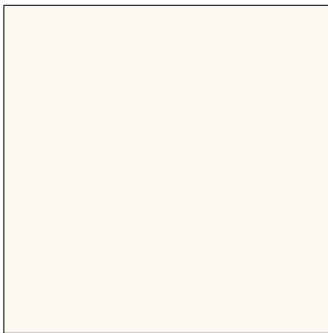

Panel - Linen

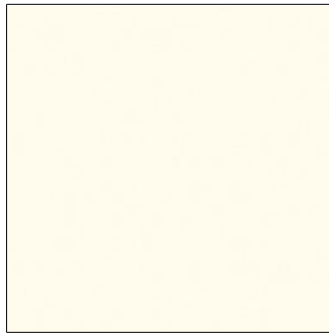

Trim - Smooth Plaster

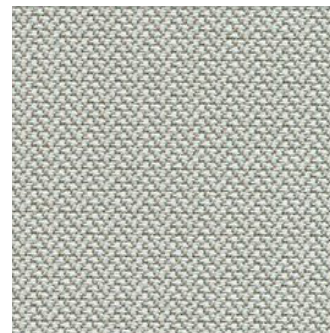

Screen - Chevron, Fence (RR)

WORKSTATIONS | Showroom - \$\$\$



Key Design Features

- Bent worksurface shape
- Angle leg
- Worksurface mounted privacy screen
- Pantry locker with saddle

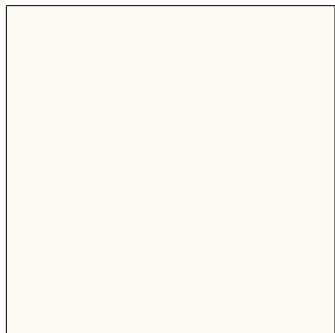
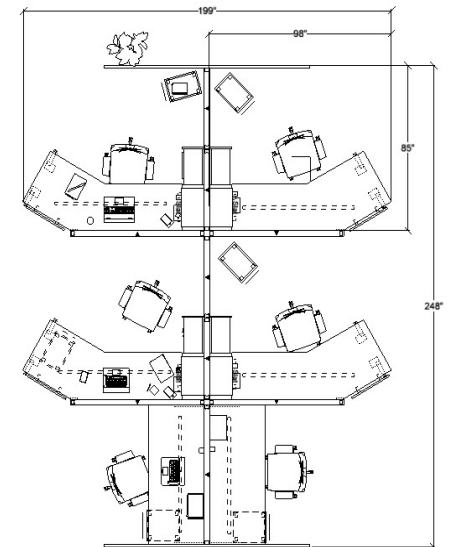

Worksurfaces - Linen



Panels - Kio, Jib (RR)

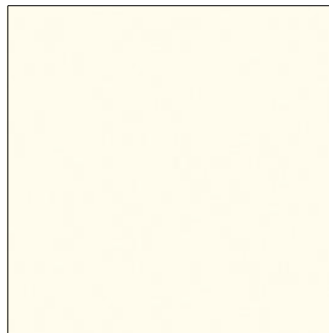

Trim - Smooth Plaster

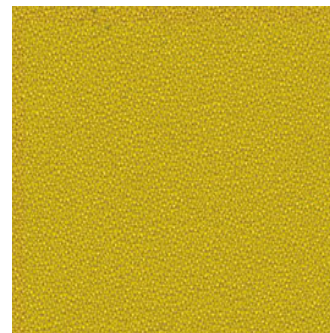

Screens - Tellure, Sprout

WORKSTATIONS | Showroom - \$



Key Design Features

- Tethered mobile HAT with footrest
- Storage on legs
- Panel mounted accessory frame with removable markerboard
- Radius surface with curved privacy screen

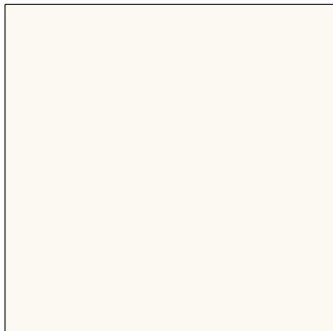
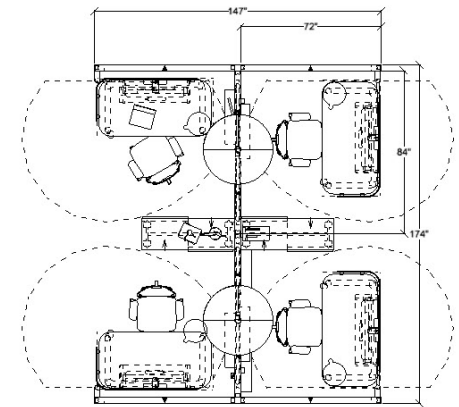

Worksurfaces - Linen

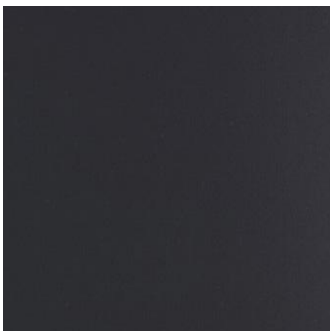

Panel - Charcoal

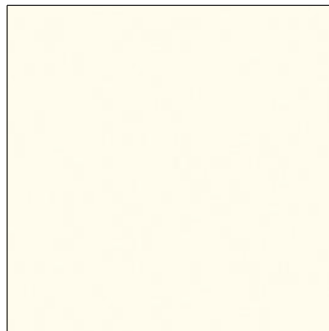

Trim - Smooth Plaster



Desk Mounted Screen - Cotswold,
Sivlerbrush